

# Catálogo mobiliario de baño Catalogue bathroom furniture



20  
18

- Sigma
- Omega
- Landes
- Landes modular
- Strip
- Cairo
- Dúo
- Ikaro
- Denim
- Lip
- Wave
- Sky
- Trent
- Escorpio
- Tauro
- Wood
- Mar
- Hole
- Aries
- Galsaky
- Small
- Homy
- Comet
- Tívoli
- Moon
- Dominó

coycama

coycama

# Índice

Index\_Índice\_Índice\_Aurkibidea\_Índice

P\_5



**Sigma**  
80\_105\_120\_140

○ ● ●

P\_17



**Omega**  
80\_100\_120

○ ● ●

P\_27



**Landes**  
60\_80\_90\_100\_120

○ ● ● ●

P\_49



**Landes modular**  
80 ... 200

○ ●

P\_67



**Strip**  
80\_100\_120

○ ●

P\_81



**Cairo**  
80\_100

○ ● ● ●

P\_89



**Dúo**  
70\_105\_140

○ ● ● ●

P\_115



**Ikaro**  
60\_80\_100\_120

○ ●

P\_129



**Denim**  
60\_80\_100\_120

○ ●

P\_141



**Lip**  
80\_100\_120

○ ●

P\_151



**Wave**  
60\_80\_100

○

P\_159



**Sky**  
60\_80\_100\_120

○

P\_167



**Trent**  
80\_100

○ ●

P\_172



**Escorpio**  
60\_70\_80\_100

○ ● ● ● ●

P\_182



**Tauro**  
70\_80\_100

○ ● ● ● ●

P\_192



**Wood**  
80\_100

○ ● ● ●

P\_200



**Mar**  
90

○ ● ●

P\_206



**Hole**  
80\_90\_100

○ ● ●

P\_214



**Aries**  
70\_80\_100

○ ● ● ● ●

P\_228



**Galsaky**  
60\_70\_80\_100

○ ● ● ● ●

P\_242



**Small**  
50\_60

○ ●

fondo reducido

P\_248



**Homy**  
70\_80

○ ●

fondo reducido

P\_254



**Comet**  
60\_70\_80

○ ●

fondo reducido

P\_260



**Tívoli**  
80\_100

○ ●

fondo reducido

P\_266



**Moon**  
50

○ ●

fondo reducido

P\_270



**Dominó**  
40

○ ● ●

fondo reducido

P\_274



**Especificaciones Técnicas**

# ■ 80/105/120/140 Sigma

## Sigma\_

Omega  
Landes  
Landes modular  
Strip  
Cairo  
Dúo  
Ikaro  
Denim  
Lip  
Wave  
Sky  
Trent  
Escorpio  
Tauro  
Wood  
Mar  
Hole  
Aries  
Galsaky  
Small  
Homy  
Comet  
Tívoli  
Moon  
Dominó



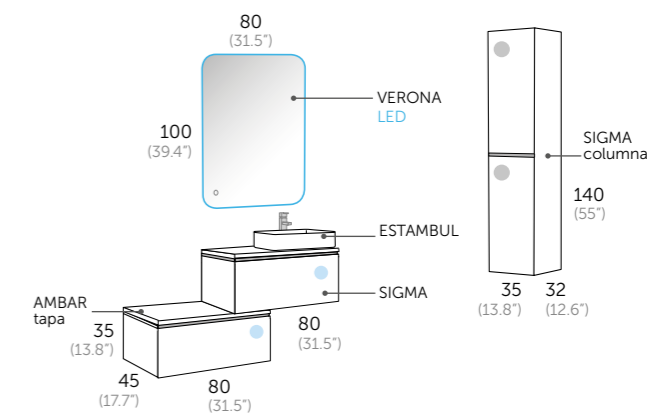

Composición **SIGMA 80 (31.5")**

- 2 190 01 080 SIGMA 80
- 2 508 01 080 AMBAR tapa
- 1 507 01 005 ESTAMBUL
- 1 246 00100 VERONA LED

Auxiliares

- 1 190 01 340 SIGMA Columnna

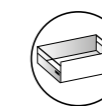

Interior cajones costilla metálicas  
 Metal interior drawers  
 Interior gaveta com guia metálica  
 Interior calaix costella metàlica  
 Kaxoi barnekaldea saihets metalikoeekin  
 Interior caixóns costela metálica



Cajón con cierre amortiguado  
 Drawer fitted with soft closing system  
 Gaveta com sistema de correijas com amortecedor  
 Calaixos amb sistema de tancament suau  
 Motelgailudun itxierazko kajoia  
 Caixon con peche amortecido



Guías Hettich  
 Hettich drawer sliding system  
 Guías Hettich  
 Guies Hettich  
 Hettich gidak  
 Guias Hettich



Puerta con cierre amortiguado  
 Door with soft closing system  
 Porta com amortecedor  
 Porta amb sistema de tancament suau  
 Motelgailudun itxierazko atea  
 Porta con peche amortecido

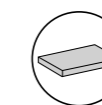

Acabado lacado mate  
 Matte lacquered finish  
 Cor lacado mate  
 Acabat lacat mat  
 Mate lakatzuko bukatua  
 Acabado lacado mate



Hidrófugo  
 More resistant to water  
 A prova d'água  
 Hidrófug  
 Hidrofugoa  
 Hidrófugo



Sistema antivaho  
 Anti fog system  
 Sistema anti-vapor  
 Sistema antibaf  
 Lurrunaren kontrako sistema  
 Sistema antivaho



Sensor de contacto On/ Off  
 Contact sensor On/ Off  
 Sensor interruptor On/ Off  
 Sensor de contacto On/ Off  
 On/Off kontaktu sentsorea  
 Sensor de contacto On/ Off

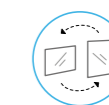

Reversible  
 It is reversible  
 Reversível  
 Reversibile  
 Itzulgarria  
 Reversible



Luz ambiental  
 Ambient light  
 Luz ambiente  
 Luz ambiental  
 Giro-argia  
 Luz ambiental

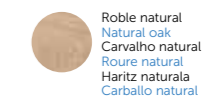

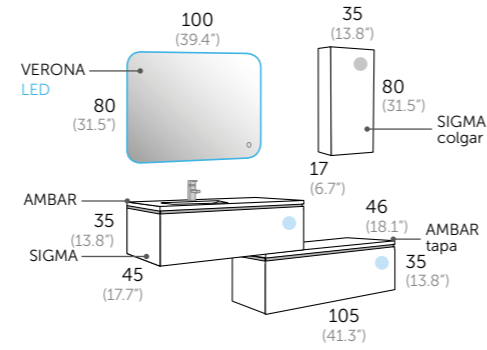

Composición **SIGMA 105** (41.3")

- 2 190 34 105 SIGMA 105
- 1 506 01 105 AMBAR
- 1 508 01 105 AMBAR tapa
- 1 246 00 100 VERONA LED

Auxiliares

- 1 190 34 435 SIGMA colgar



- Blanco mate  
Matte white  
Branco mate  
Blanc mat  
Zuri matea  
Branco mate
- Gris intenso mate  
Matte dark grey  
Cinzento intenso mate  
Gris intens mat  
Gris mate bizia  
Gris intenso mate
- Roble natural  
Natural oak  
Carvalho natural  
Roure natural  
Haritz naturala  
Carballo natural

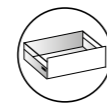

Interior cajones costilla metálicas  
*Metal interior drawers*  
Interior gaveta com guia metálica  
*Interior caixa costella metálica*  
Kaxoi barnekaldea saihets metalikoekin  
*Interior caixons costela metálica*

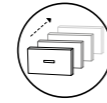

Cajón con cierre amortiguado  
*Drawer fitted with soft closing system*  
Gaveta com sistema de correções com amortecedor  
*Caixaos amb sistema de tancament suau*  
Motelgailudun itxierazko kajoia  
*Caixón con peche amortecido*



Guías Grass  
*Grass drawer sliding system*  
Guia Grass  
*Guias Grass*  
Grass gidak  
*Guias Grass*



Puerta con cierre amortiguado  
*Door with soft closing system*  
Porta com amortecedor  
*Porta amb sistema de tancament suau*  
Motelgailudun itxierazko atea  
*Porta con peche amortecido*

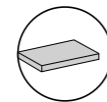

Acabado lacado mate  
*Matte lacquered finish*  
Cor lacado mate  
*Acabat lacat mat*  
Mate lakatzuko bukatua  
*Acabado lacado mate*



Hidrófugo  
*More resistant to water*  
À prova d'água  
*Hidrofug*  
Hidrofugoa  
*Hidrófugo*



Reversible  
*It is reversible*  
Reversibel  
*Reversible*  
Itzulgarria  
*Reversible*



Sistema antivaho  
*Anti fog system*  
Sistema anti-vapor  
*Sistema antibaf*  
Lurrunaren kontrako sistema  
*Sistema antivaho*



Luz ambiental  
*Ambient light*  
Luz ambiente  
*Llum ambiental*  
Giro-argia  
*Luz ambiental*



Sensor de contacto On/ Off  
*Contact sensor On/ Off*  
Sensor interruptor On/ Off  
*Sensor de contacte On/ Off*  
On/Off kontaktu sentsorea  
*Sensor de contacto On/ Off*



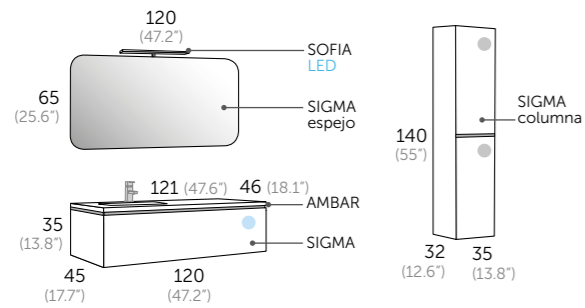

Composición **SIGMA 120** (47.2")

- 1 190 24 120 SIGMA 120
- 1 506 01 121 AMBAR
- 1 290 00 120 SIGMA espejo
- 1 400 00 141 SOFIA LED

Auxiliares

- 1 190 24 340 SIGMA Columna

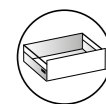

Interior cajones costilla metálicas  
*Metal interior drawers*  
 Interior gaveta com guia metálica  
*Interior caixa costella metálica*  
 Kaxoi barnekaldea saihets metalikoekin  
*Interior caixóns costela metálica*

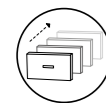

Cajón con cierre amortiguado  
*Drawer fitted with soft closing system*  
 Gaveta com sistema de correções com amortecedor  
*Calaixos amb sistema de tancament suau*  
 Motelgailudun itxierazko kajoia  
*Caixón con peche amortecido*



Guías Grass  
*Grass drawer sliding system*  
 Guia Grass  
 Guias Grass  
 Grass gidak  
 Guias Grass



Puerta con cierre amortiguado  
*Door with soft closing system*  
 Porta com amortecedor  
 Porta amb sistema de tancament suau  
 Motelgailudun itxierazko atea  
 Porta con peche amortecido

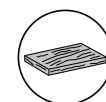

Acabado melamina con textura  
*Textured melamine finish*  
 Cor melamina com textura  
 Acabat melamina amb textura  
 Testuradun melamina bukatua  
 Acabado melamina con textura



Hidrófugo  
*More resistant to water*  
 À prova d'água  
 Hidrófug  
 Hidrofugoa  
 Hidrófugo



Blanco mate  
 Matte white  
 Branco mate  
 Blanc mat  
 Zuri matea  
 Branco mate



Gris intenso mate  
 Matte dark grey  
 Cinzento intenso mate  
 Gris intens mat  
 Gris mate bizia  
 Gris intenso mate



Roble natural  
 Natural oak  
 Carvalho natural  
 Roure natural  
 Haritz naturala  
 Carballo natural



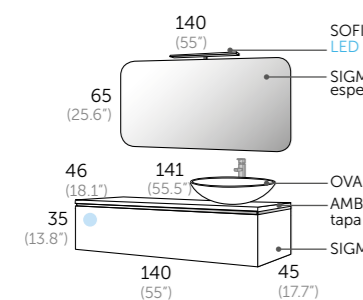

Composición **SIGMA 140 (55")**

- 1 190 24 140 SIGMA 140
- 1 508 01 140 AMBAR tapa
- 1 509 01 001 OVAL
- 1 290 00 140 SIGMA espejo
- 1 400 00 141 SOFIA LED

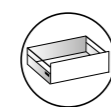
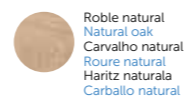

Interior cajones costilla metálicas  
*Metal interior drawers*  
 Interior gaveta com guia metálica  
*Interior calaix costella metàlica*  
 Kaxoi barnekaldea saihets metalikoekin  
*Interior caixóns costela metàlica*



Guías Grass  
*Grass drawer sliding system*  
 Guia Grass  
*Guiies Grass*  
 Grass gidak  
*Guias Grass*

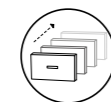

Cajón con cierre amortiguado  
*Drawer fitted with soft closing system*  
 Gaveta com sistema de correções com amortecedor  
*Calaixos amb sistema de tancament suau*  
 Motelgailudun itxierazko kajoia  
*Caixón con peche amortecido*



Acabado melamina con textura  
*Textured melamine finish*  
 Cor melamina con textura  
*Acabat melamina amb textura*  
 Testura dun melamina bukatua  
*Acabado melamina con textura*



Hidrófugo  
*More resistant to water*  
 À prova d'água  
*Hidrofug*  
 Hidrofugoa  
*Hidrofugoa*

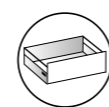
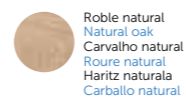

Interior cajones costilla metálicas  
*Metal interior drawers*  
 Interior gaveta com guia metálica  
*Interior calaix costella metàlica*  
 Kaxoi barnekaldea saihets metalikoekin  
*Interior caixóns costela metàlica*



Guías Grass  
*Grass drawer sliding system*  
 Guia Grass  
*Guiies Grass*  
 Grass gidak  
*Guias Grass*



Cajón con cierre amortiguado  
*Drawer fitted with soft closing system*  
 Gaveta com sistema de correções com amortecedor  
*Calaixos amb sistema de tancament suau*  
 Motelgailudun itxierazko kajoia  
*Caixón con peche amortecido*

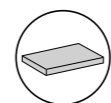

Acabado lacado mate  
*Matte lacquered finish*  
 Cor lacado mate  
*Acabat lacat mat*  
 Mate lakatzuko bukatua  
*Acabado lacado mate*



Hidrófugo  
*More resistant to water*  
 À prova d'água  
*Hidrofug*  
 Hidrofugoa  
*Hidrofugoa*

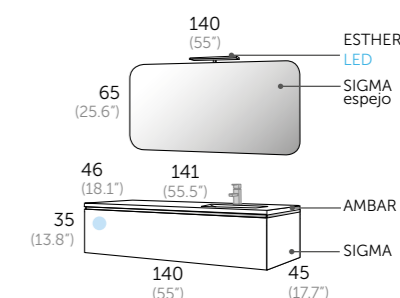

Composición **SIGMA 140 (55")**

- 1 190 01 140 SIGMA 140
- 1 506 01 144 AMBAR
- 1 290 00 140 SIGMA espejo
- 1 400 00 121 ESTHER LED





## SIGMA\_80 (31.5")

ESPEJOS Y CAMERINOS más opciones en págs. 316 - 325

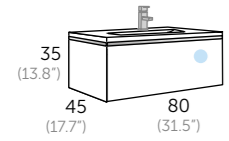

- Acabado Referencia
- Blanco mate 190 01 080
  - Gris intenso mate 190 34 080
  - Roble natural 190 24 080

### ENCIMERAS / countertops / lavatorios / lavabos / gainekoak / encimeras

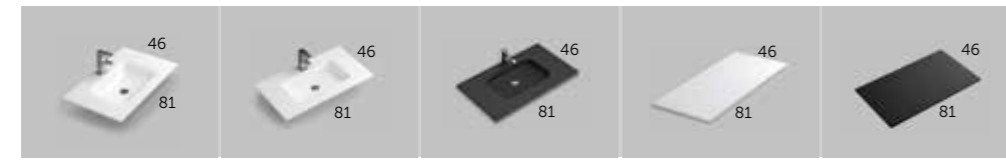

- |  |  |  |   |   |
|--|--|--|---|---|
| <b>JADE</b> masa blanca<br>Referencia 504 01 080 | <b>AMBAR</b> mate<br>Referencia 506 01 080 | <b>MASAI</b><br>Referencia 518 02 080<br>Más colores en pág. 308-311 | <b>AMBAR TAPA</b> mate<br>Referencia 508 01 080 | <b>MASAI TAPA</b><br>Referencia 519 02 080<br>Más colores en pág. 313 |
|--|--|--|---|---|

## SIGMA\_105 (41.3")

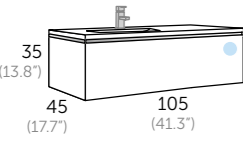

- Acabado Referencia
- Blanco mate 190 01 105
  - Gris intenso mate 190 34 105
  - Roble natural 190 24 105

### ENCIMERAS / countertops / lavatorios / lavabos / gainekoak / encimeras



- |  |  |  |   |   |
|--|--|--|---|---|
| <b>JADE</b> masa blanca<br>Referencia 504 01 105<br>Izda. 504 01 105<br>Dcha. 504 01 106 | <b>AMBAR</b> mate<br>Referencia 506 01 105<br>Izda. 506 01 105<br>Dcha. 506 01 106 | <b>MASAI</b><br>Referencia 518 02 105<br>Más colores en pág. 308-311 | <b>AMBAR TAPA</b> mate<br>Referencia 508 01 105 | <b>MASAI TAPA</b><br>Referencia 519 02 105<br>Más colores en pág. 313 |
|--|--|--|---|---|

## SIGMA\_120 (47.2")

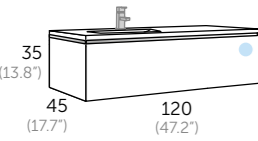

- Acabado Referencia
- Blanco mate 190 01 120
  - Gris intenso mate 190 34 120
  - Roble natural 190 24 120

### ENCIMERAS / countertops / lavatorios / lavabos / gainekoak / encimeras



- |  |  |  |  |  |   |
|--|--|--|--|--|---|
| <b>AMBAR</b> mate<br>Referencia 506 01 120 | <b>AMBAR</b> mate<br>Referencia 506 01 121<br>Dcha. 506 01 123 | <b>AMBAR</b> mate<br>Referencia 506 01 122 | <b>MASAI</b><br>Referencia 506 02 122<br>Más colores en pág. 308-311 | <b>AMBAR TAPA</b><br>Referencia 508 01 120 | <b>MASAI TAPA</b><br>Referencia 519 02 120<br>Más colores en pág. 313 |
|--|--|--|--|--|---|

## SIGMA\_140 (55")

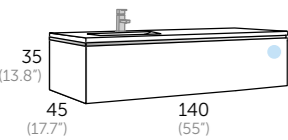

- Acabado Referencia
- Blanco mate 190 01 140
  - Gris intenso mate 190 34 140
  - Roble natural 190 24 140

### ENCIMERAS / countertops / lavatorios / lavabos / gainekoak / encimeras

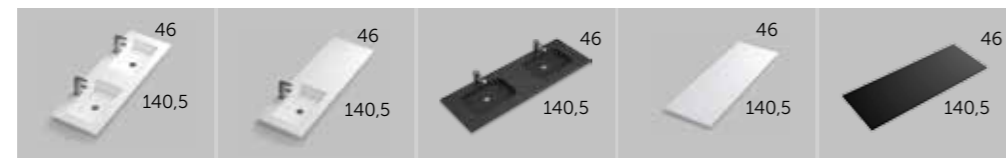

- |  |  |  |   |   |
|--|--|--|---|---|
| <b>AMBAR</b> mate<br>Referencia 506 01 142 | <b>AMBAR</b> mate<br>Referencia 506 01 143<br>Dcha. 506 01 144 | <b>MASAI</b><br>Referencia 518 02 140<br>Más colores en pág. 308-311 | <b>AMBAR TAPA</b> mate<br>Referencia 508 01 140 | <b>MASAI TAPA</b><br>Referencia 519 02 140<br>Más colores en pág. 313 |
|--|--|--|---|---|

### LAVABOS / washbasins / lavatorio pousar / lavabo sobreposar / gainjarritako konketa / lavabo sobrepoñer



- |  |   |  |   |  |
|--|---|--|---|--|
| <b>ROTTERDAM</b><br>cerámica<br>Referencia 507 01 004<br>Altura: 10,5 cm | <b>ESTAMBUL</b><br>cerámica<br>Referencia 507 01 005<br>Altura: 10,5 cm | <b>AMBERES</b><br>cerámica<br>Referencia 507 01 003<br>Altura: 12,5 cm | <b>LANDES</b><br>cerámica<br>Referencia 507 01 002<br>Altura: 13 cm | <b>OVAL</b> mate<br>Referencia 509 01 001<br>Altura: 12 cm |
|--|---|--|---|--|

más opciones en págs. 314 - 315

### ESPEJOS / mirrors / espelhos / miralls / ispiluak / espellos

### CAMERINOS armóires / armário com espelho / camerinos kamerinoak / camerinos /

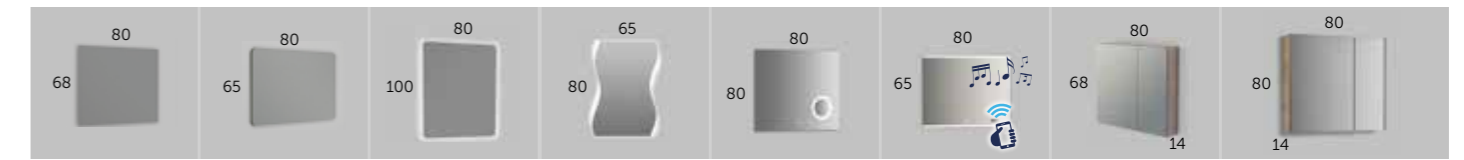

- |                                       |                                       |  |  |  |   |                                       |   |
|---------------------------------------|---------------------------------------|--|--|--|---|---------------------------------------|---|
| <b>CLOUD</b><br>Referencia 205 00 080 | <b>SIGMA</b><br>Referencia 290 00 080 | <b>VERONA LED</b><br>Referencia 246 00 100 | <b>MÓDENA LED</b><br>Referencia 264 00 080 | <b>HOLMES LED</b><br>Referencia 263 00 080 | <b>SPOTY LED</b><br>Referencia 267 00 080 | <b>FLASH</b><br>Referencia 340 11 080 | <b>SKYLINE</b><br>Referencia 341 24 080<br>341 11 080 |
|---------------------------------------|---------------------------------------|--|--|--|---|---------------------------------------|---|

### ESPEJOS / mirrors / espelhos / miralls / ispiluak / espellos

### CAMERINO

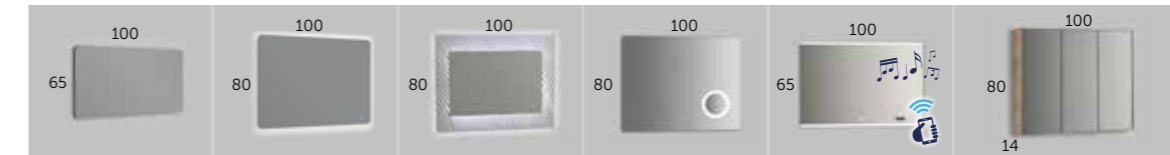

- |                                       |  |   |  |   |   |
|---------------------------------------|--|---|--|---|---|
| <b>SIGMA</b><br>Referencia 290 00 100 | <b>VERONA LED</b><br>Referencia 246 00 100 | <b>CEBRA LED</b><br>Referencia 265 00 100 | <b>HOLMES LED</b><br>Referencia 263 00 100 | <b>SPOTY LED</b><br>Referencia 267 00 100 | <b>SKYLINE</b><br>Referencia 341 24 100<br>341 11 100 |
|---------------------------------------|--|---|--|---|---|

### ESPEJOS / mirrors / espelhos / miralls / ispiluak / espellos

### CAMERINOS armóires / armário com espelho / camerinos kamerinoak / camerinos /

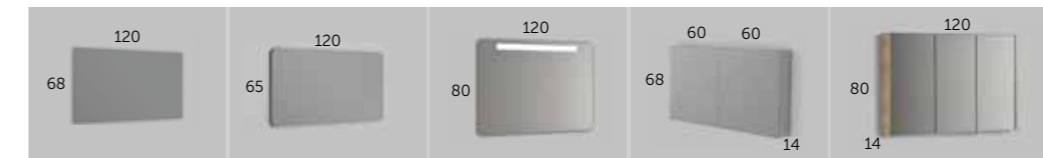

- |                                       |                                       |  |                                       |   |
|---------------------------------------|---------------------------------------|--|---------------------------------------|---|
| <b>CLOUD</b><br>Referencia 205 00 120 | <b>SIGMA</b><br>Referencia 290 00 120 | <b>RAIN LED</b><br>Referencia 269 00 120 | <b>FLASH</b><br>Referencia 340 11 060 | <b>SKYLINE</b><br>Referencia 341 24 120<br>341 11 120 |
|---------------------------------------|---------------------------------------|--|---------------------------------------|---|

### ESPEJOS / mirrors / espelhos / miralls / ispiluak / espellos

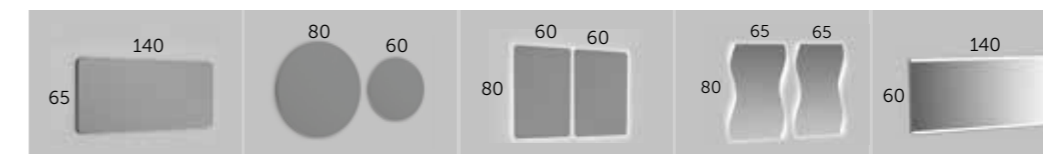

- |                                       |   |  |  |   |
|---------------------------------------|---|--|--|---|
| <b>SIGMA</b><br>Referencia 290 00 140 | <b>REDONDO</b><br>Referencia 244 00 060<br>244 00 080 | <b>VERONA LED</b><br>Referencia 246 00 060 | <b>MÓDENA LED</b><br>Referencia 264 00 080 | <b>TOWER LED</b><br>Referencia 262 00 140 |
|---------------------------------------|---|--|--|---|

### AUXILIARES / auxiliary units / auxiliares / auxiliars / osagarriak / auxiliares

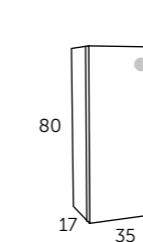

- SIGMA colgar**
- Acabado Referencia
- Blanco mate 190 01 435
  - Gris intenso mate 190 34 435
  - Roble natural 190 24 435

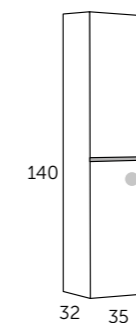

- SIGMA columna**
- Acabado Referencia
- Blanco mate 190 01 340
  - Gris intenso mate 190 34 340
  - Roble natural 190 24 340

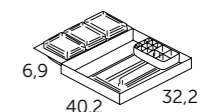

- Organizador opcional**
- Referencia 411 00 001

## APLIQUES más opciones en pág. 326



- |  |   |
|--|---|
| <b>ESTHER LED</b><br>Referencia 400 00 121<br>luz fría<br>400 00 221<br>luz cálida | <b>SOFIA LED</b><br>Referencia 400 00 141<br>luz fría<br>400 00 241<br>luz cálida |
|--|---|

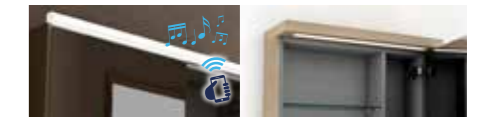

- |   |   |
|---|---|
| <b>Aplique SKYLINE LED</b><br>cm Referencia | <b>Cornisa SKYLINE LED</b><br>cm Referencia |
| 60 400 00 511                               | 60 341 24 061                               |
| 80 400 00 521                               | 80 341 24 081                               |
| 100 400 00 531                              | 100 341 24 101                              |
| 120 400 00 541                              | 120 341 24 121                              |
- Más colores en pág. 323



Sigma  
**Omega\_**  
Landes  
Landes modular  
Strip  
Cairo  
Dúo  
Ikaro  
Denim  
Lip  
Wave  
Sky  
Trent  
Escorpio  
Tauro  
Wood  
Mar  
Hole  
Aries  
Galsaky  
Small  
Homy  
Comet  
Tívoli  
Moon  
Dominó

# Omega

\_80/100/120

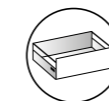

Interior cajones costilla metálicas  
*Metal interior drawers*  
 Interior gaveta com guia metálica  
*Interior calaix costella metálica*  
 Kaxoi barnekaldea saihets metalikoekin  
*Interior caixóns costela metálica*

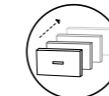

Cajón con cierre amortiguado  
*Drawer fitted with soft closing system*  
 Gaveta com sistema de correções com amortecedor  
*Calaixos amb sistema de tancament suau*  
 Motelgailudun itxierazko kajoia  
*Caixón con peche amortecido*



Guías Hettich  
*Hettich drawer sliding system*  
 Guías Hettich  
*Hettich gidak*  
 Guías Hettich

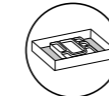

Organizador en cajón superior  
*Organizer unit on top drawer*  
 Organizador de gaveta  
*Organizador en calaixos superiors*  
 Antolatzaila goikaldeko kajoian  
*Organizador en caixón superior*

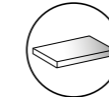

Acabado lacado brillo  
*High gloss lacquered finish*  
 Cor lacado brilho  
*Acabat lacat brillant*  
 Distiradun lakatzuko bukatua  
*Acabado lacado brillo*



Hidrófugo  
*More resistant to water*  
 À prova d'água  
*Hidrófug*  
 Hidrofugoa  
*Hidrófugo*



Sistema antivaho  
*Anti fog system*  
 Sistema anti-vapor  
*Sistema antiab*  
 Lurraren kontrako sistema  
*Sistema antivaho*



Sensor de contacto On/ Off  
*Contact sensor On/ Off*  
 Sensor interruptor On/ Off  
*Sensor de contacte On/ Off*  
 On/Off kontaktu sentorea  
*Sensor de contacto On/ Off*



Reversible  
*It is reversible*  
 Reversível  
*Reversível*  
 Itzulgarria  
*Reversible*



Luz ambiental  
*Ambient light*  
 Luz ambiente  
*Llum ambiental*  
 Giro-argia  
*Luz ambiental*



Blanco  
 White  
 Branco  
 Blanc  
 Zuria  
 Branco



Gris  
 Grey  
 Cinzento  
 Gris  
 Grisa  
 Gris



Moka  
 Mink  
 Moka  
 Moka  
 Moka



Encimera Masai con opción esquinas curvas

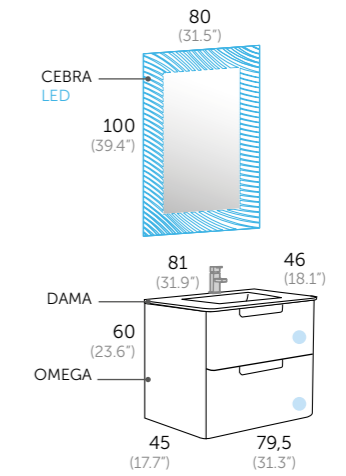

Composición **OMEGA 80 (31.5")**

- 1 193 01 080 OMEGA 80
- 1 503 01 080 DAMA
- 1 265 00 100 CEBRA LED



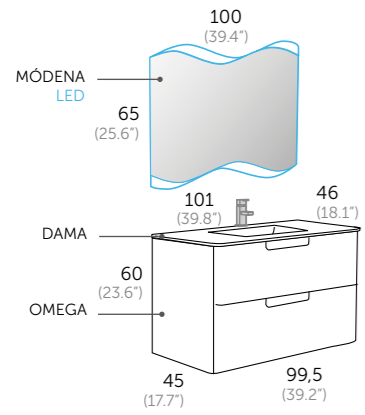

Composición **OMEGA 100 (39.4")**

- 1 193 16 100 OMEGA 100
- 1 503 01 100 DAMA
- 1 264 00 100 MÓDENA LED

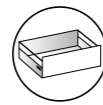

Interior cajones costilla metálicas  
*Metal interior drawers*  
 Interior gaveta com guia metálica  
*Interior caixa costella metálica*  
 Kaxoi barnekaldea saihets metalikoekin  
*Interior caixóns costela metálica*



Cajón con cierre amortiguado  
*Drawer fitted with soft closing system*  
 Gaveta com sistema de corredeiras com amortecedor  
*Caixaos amb sistema de tancament suau*  
 Motelgailudun itxierazko kajoia  
*Caixón con peche amortecido*



Guías Hettich  
*Hettich drawer sliding system*  
 Guías Hettich  
*Hettich gidak*  
 Hettich gidak  
*Guías Hettich*

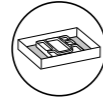

Organizador en cajón superior  
*Organizer unit on top drawer*  
 Organizador de gaveta  
*Organizador en caixaos superiors*  
 Antolatzailea goikaldeko kajoian  
*Organizador en caixón superior*

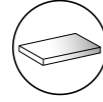

Acabado lacado brillo  
*High gloss lacquered finish*  
 Cor lacado brilho  
*Acabat lacat brillant*  
 Distiradun lakatzuko bukatua  
*Acabado lacado brillo*



Hidrófugo  
*More resistant to water*  
 À prova d'água  
*Hidrófug*  
 Hidrofugoa  
*Hidrófugo*



Sistema antivaho  
*Anti fog system*  
 Sistema anti-vapor  
*Sistema antibaf*  
 Lurrunaren kontrako sistema  
*Sistema antivaho*



Sensor de contacto On/ Off  
*Contact sensor On/ Off*  
 Sensor interruptor On/ Off  
*Sensor de contacte On/ Off*  
 On/Off kontaktu sensorea  
*Sensor de contacto On/ Off*



Reversible  
*It is reversible*  
 Reversible  
*Reversible*  
 Itzulgarria  
*Reversible*



Luz ambiental  
*Ambient light*  
 Luz ambiente  
*Llum ambiental*  
 Giro-argia  
*Luz ambiental*





- Bianco  
White  
Branco  
Bianc  
Zuria  
Branco
- Gris  
Grey  
Cinzento  
Gris  
Grisa  
Gris
- Moka  
Mink  
Moka  
Moka  
Moka

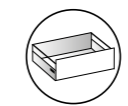

Interior cajones costilla metálicas  
*Metal interior drawers*  
Interior gaveta com guia metálica  
*Interior caixa costella metálica*  
Kaxoi barnekaldea saiñets metalikoekin  
*Interior caixóns costela metálica*



Cajón con cierre amortiguado  
*Drawer fitted with soft closing system*  
Gaveta com sistema de correções com amortecedor  
*Caixaos amb sistema de tancament suau*  
Motelgailudun itxierazko kajoia  
*Caixón con peche amortecido*

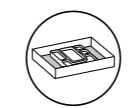

Organizador en cajón superior  
*Organizer unit on top drawer*  
Organizador de gaveta  
*Organizador en caixaos superiors*  
Antolatzailea goikaldeko kajoian  
*Organizador en caixón superior*



Guías Hettich  
*Hettich drawer sliding system*  
Guías Hettich  
*Guias Hettich*  
Hettich gidak  
*Guias Hettich*



Puerta con cierre amortiguado  
*Door with soft closing system*  
Porta com amortecedor  
*Porta amb sistema de tancament suau*  
Motelgailudun itxierazko atea  
*Porta con peche amortecido*

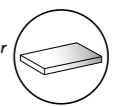

Acabado lacado brillo  
*High gloss lacquered finish*  
Cor lacado brilhante  
*Acabat lacat brillant*  
Distiradun lakatzuzko bukatua  
*Acabado lacado brillo*



Hidrófugo  
*More resistant to water*  
À prova d'água  
*Hidrófug*  
Hidrofugoa  
*Hidrófugo*

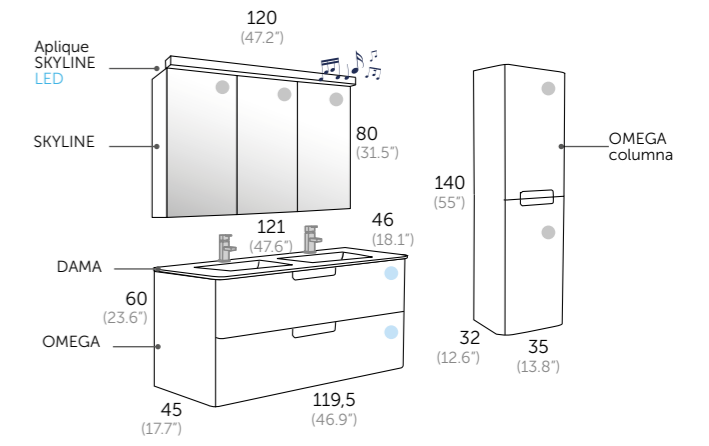

Composición **OMEGA 120 (47.2")**

- 1 193 16 120 OMEGA 120
- 1 503 01 122 DAMA
- 1 341 16 120 SKYLINE
- 1 400 00 541 Aplique SKYLINE LED

Auxiliares

- 1 193 16 335 OMEGA Columna



## OMEGA\_80 (31.5")

ESPEJOS Y CAMERINOS más opciones en págs. 316 - 325

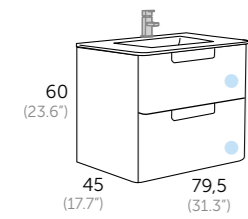

Acabado Referencia  
 ○ Blanco 193 01 080  
 ● Gris 193 03 080  
 ● Moka 193 16 080

### ENCIMERAS / countertops / lavatorios / lavabo / gaineoak / encimeras



**DAMA** cerámica  
 Referencia  
 503 01 080

**MASAI ESQUINAS CURVAS**  
 Referencia  
 518 02 080 C  
 Más colores en pág. 308-311  
 Bajo pedido

### ESPEJOS / mirrors / espelhos / miralls / ispiluak / espellos

### CAMERINOS

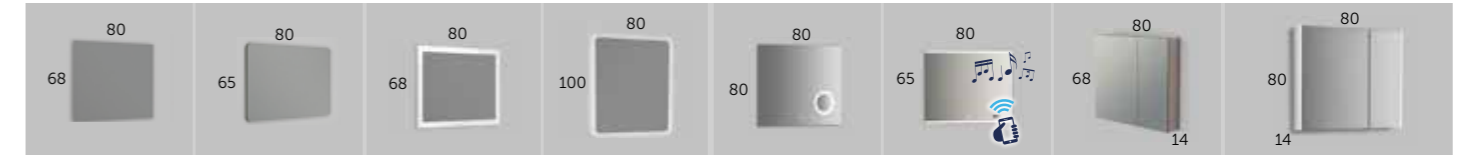

**MOON**  
 Referencia  
 200 00 080

**SIGMA**  
 Referencia  
 290 00 080

**TOOL**  
 Referencia  
 ○ 207 01 080  
 ● 207 03 080

**VERONA LED**  
 Referencia  
 246 00 100

**HOLMES LED**  
 Referencia  
 263 00 080

**SPOTY LED**  
 Referencia  
 267 00 080

**FLASH**  
 Referencia  
 340 11 080

**SKYLINE**  
 Referencia  
 ○ 341 01 080  
 ● 341 03 080  
 ● 341 16 080

## OMEGA\_100 (39.4")

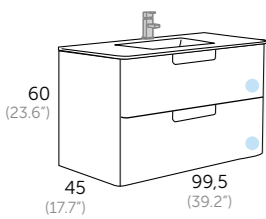

Acabado Referencia  
 ○ Blanco 193 01 100  
 ● Gris 193 03 100  
 ● Moka 193 16 100

### ENCIMERAS / countertops / lavatorios / lavabo / gaineoak / encimeras



**DAMA** cerámica  
 Referencia  
 503 01 100

**MASAI ESQUINAS CURVAS**  
 Referencia  
 518 02 100 C  
 Más colores en pág. 308-311  
 Bajo pedido

### ESPEJOS / mirrors / espelhos / miralls / ispiluak / espellos

### CAMERINOS

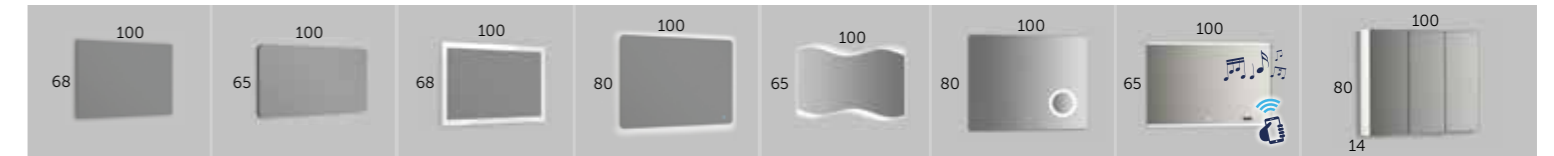

**MOON**  
 Referencia  
 200 00 100

**SIGMA**  
 Referencia  
 290 00 100

**TOOL**  
 Referencia  
 ○ 207 01 100  
 ● 207 03 100

**VERONA LED**  
 Referencia  
 246 00 100

**MÓDENA LED**  
 Referencia  
 264 00 100

**HOLMES LED**  
 Referencia  
 263 00 100

**SPOTY LED**  
 Referencia  
 267 00 100

**SKYLINE**  
 Referencia  
 ○ 341 01 100  
 ● 341 03 100  
 ● 341 16 100

## OMEGA\_120 (47.2")

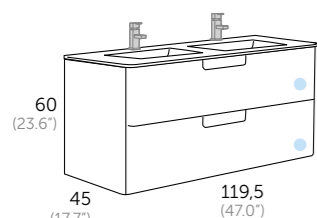

Acabado Referencia  
 ○ Blanco 193 01 120  
 ● Gris 193 03 120  
 ● Moka 193 16 120

### ENCIMERAS / countertops / lavatorios / lavabo / gaineoak / encimeras



**DAMA** cerámica  
 Referencia  
 503 01 120

**DAMA** cerámica  
 Referencia  
 503 01 122

**MASAI ESQ. CURVAS**  
 Referencia  
 518 02 120 C  
 Más colores en pág. 308-311  
 Bajo pedido

**MASAI ESQ. CURVAS**  
 Referencia  
 518 02 122 C  
 Más colores en pág. 308-311  
 Bajo pedido

### ESPEJOS / mirrors / espelhos / miralls / ispiluak / espellos

### CAMERINOS

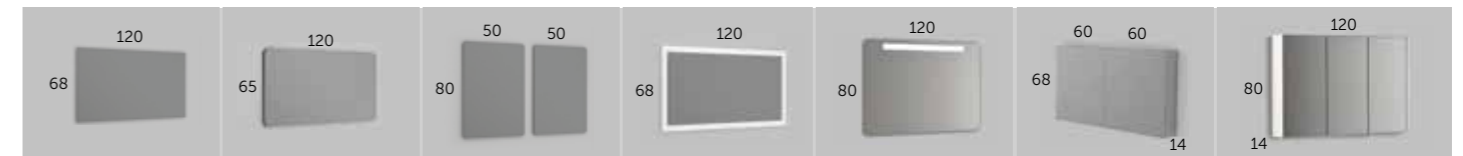

**MOON**  
 Referencia  
 200 00 120

**SIGMA**  
 Referencia  
 290 00 120

**NITRO**  
 Referencia  
 241 00 050

**TOOL**  
 Referencia  
 ○ 207 01 120  
 ● 207 03 120

**RAIN LED**  
 Referencia  
 269 00 120

**FLASH**  
 Referencia  
 340 11 060

**SKYLINE**  
 Referencia  
 ○ 341 01 120  
 ● 341 03 120  
 ● 341 16 120

## AUXILIARES / auxiliary units / auxiliares / auxiliars / osagarriak / auxiliares

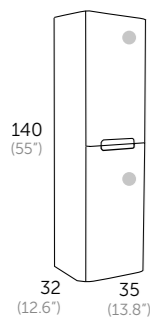

Acabado Referencia  
 ○ Blanco 193 01 335  
 ● Gris 193 03 335  
 ● Moka 193 16 335



**Válvula universal CLIC CLAC**  
 Referencia  
 51601

## APLIQUES / spotlights / apliques / aplics / ezarkinak / apliques



**ESTHER LED**  
 Referencia  
 400 00 121  
 luz fría  
 400 00 221  
 luz cálida

**SOFIA LED**  
 Referencia  
 400 00 141  
 luz fría  
 400 00 241  
 luz cálida

**AINHOA LED**  
 Referencia  
 400 00 151  
 luz fría

**NIKITA LED**  
 Referencia  
 400 01 171  
 luz fría

**NAYRA LED**  
 Referencia  
 400 00 181  
 luz fría

**Aplique SKYLINE LED**  
 cm Referencia  
 60 400 00 511  
 80 400 00 521  
 100 400 00 531  
 120 400 00 541

**Cornisa SKYLINE LED**  
 cm Referencia  
 60 341 01 061  
 80 341 01 081  
 100 341 01 101  
 120 341 01 121  
 Más colores en pág. 323

60/80/90/100/120

# Landes



Sigma  
Omega  
**Landes**  
Landes modular  
Strip  
Cairo  
Dúo  
Ikaro  
Denim  
Lip  
Wave  
Sky  
Trent  
Escorpio  
Tauro  
Wood  
Mar  
Hole  
Aries  
Galsaky  
Small  
Homy  
Comet  
Tivoli  
Moon  
Dominó



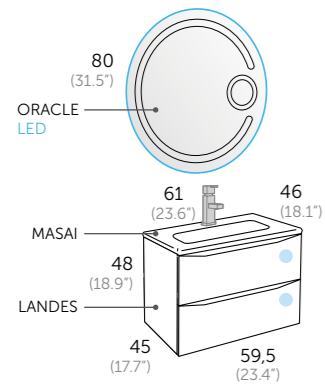

Composición **LANDES 60** (23.6")

- 1 112 16 060 LANDES 60
- 1 518 06 060 MASAI
- 1 260 00 080 ORACLE LED

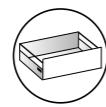

Interior cajones costilla metálicas  
Metal interior drawers  
Interior gaveta com guia metálica  
Interior calaix costella metàlica  
Kaxoi barnekaldea saihets metalikoeekin  
Interior caixòns costela metàlica



Cajón con cierre amortiguado  
Drawer fitted with soft closing system  
Gaveta com sistema de corredeiras com amortecedor  
Calaixos amb sistema de tancament suau  
Motelgailudun itxierazko kajoia  
Caixón con peche amortecido



Guías Hettich  
Hettich drawer sliding system  
Guias Hettich  
Guias Hettich  
Hettich gidak  
Guías Hettich

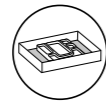

Organizador en cajón superior  
Organizer unit on top drawer  
Organizador de gaveta  
Organizador en calaixos superiors  
Antolatzailea goikaldeko kajoian  
Organizador en caixón superior

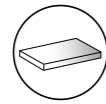

Acabado lacado brillo  
High gloss lacquered finish  
Cor lacado briho  
Acabat lacat brillant  
Distiradun lakatzuzko bukatua  
Acabado lacado brillo



Hidrófugo  
More resistant to water  
À prova d'água  
Hidrófug  
Hidrofugoa  
Hidrófugo



Sistema antivaho  
Anti fog system  
Sistema anti-vapor  
Sistema antibaf  
Lurrunaren kontrako sistema  
Sistema antivaho



Sensor de contacto On/ Off  
Contact sensor On/ Off  
Sensor interruptor On/ Off  
Sensor de contacte On/ Off  
On/Off kontaktu sentsorea  
Sensor de contacto On/ Off



Lupa aumento x3  
Magnifying zoom in Mirror  
Lupa aumento 3x  
Lupa augment x3  
3x-eko haundiagotze lupa  
Lupa aumento x3



Blanco mate  
Matte white  
Branco mate  
Blanc mat  
Zuri matea  
Branco mate

Roble natural  
Natural oak  
Carvalho natural  
Roure natural  
Haritz naturala  
Carballo natural

Gris  
Grey  
Cinzento  
Gris  
Grisa  
Gris

Moka  
Mink  
Moka  
Moka  
Moka  
Moka





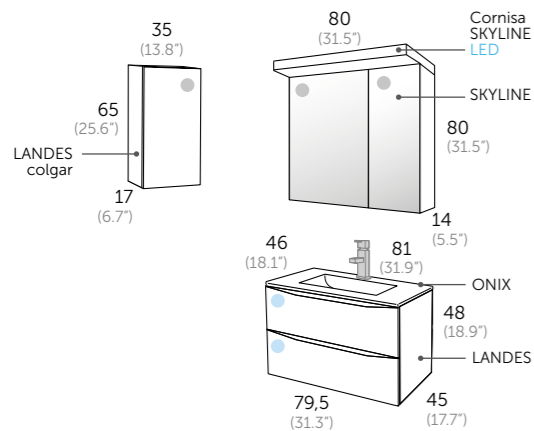

Composición **LANDES 80 (31.5")**

- 1 112 03 080 LANDES 80
- 1 500 01 080 ONIX
- 1 341 03 080 SKYLINE
- 1 341 03 081 Cornisa SKYLINE LED

Auxiliares

- 1 112 03 435 LANDES colgar

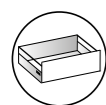

Interior cajones costilla metálicas  
*Metal interior drawers*  
 Interior gaveta com guia metálica  
*Interior calaix costella metálica*  
 Kaxoi barnekaldea saihets metalikoekin  
*Interior caixóns costela metálica*



Puerta con cierre amortiguado  
*Door with soft closing system*  
 Porta com amortecedor  
*Porta amb sistema de tancament suau*  
 Motelgailudun itxierazko atea  
*Porta con peche amortecido*

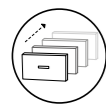

Cajón con cierre amortiguado  
*Drawer fitted with soft closing system*  
 Gaveta com sistema de corredeiras com amortecedor  
*Calaixos amb sistema de tancament suau*  
 Motelgailudun itxierazko kajoia  
*Caixón con peche amortecido*



Puerta con apertura push  
*Door with push to open*  
 Porta abertura com push  
*Porta amb obertura push*  
 Push irekieradun atea  
*Porta con apertura push*



Guías Hettich  
*Hettich drawer sliding system*  
 Guías Hettich  
*Hettich gidak*  
 Hettich gidak  
*Guías Hettich*

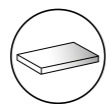

Acabado lacado brillo  
*High gloss lacquered finish*  
 Cor lacado brilho  
*Acabat lacat brillant*  
 Distiradun lakatzuko bukatua  
*Acabado lacado brillo*

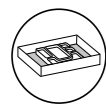

Organizador en cajón superior  
*Organizer unit on top drawer*  
 Organizador de gaveta  
*Organizador en calaixos superiors*  
 Antolatzailea goikaldeko kajoian  
*Organizador en caixón superior*



Hidrófugo  
*More resistant to water*  
 À prova d'água  
*Hidrófug*  
 Hidrofugoa  
*Hidrófugo*

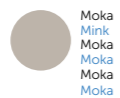
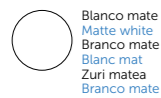

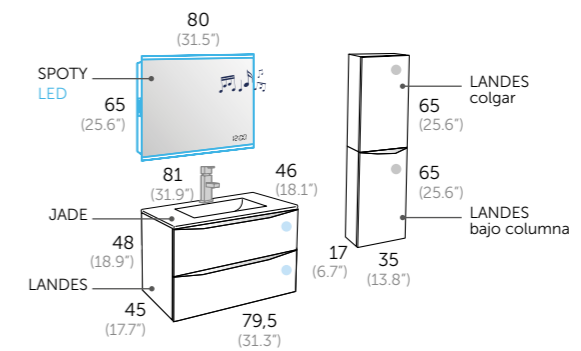

Composición **LANDES 80 (31.5")**

- 1 112 35 080 LANDES 80
- 1 504 01 080 JADE
- 1 267 00 080 SPOTY LED

Auxiliares

- 1 112 35 435 LANDES colgar
- 1 112 35 035 LANDES bajo columna dcha.

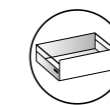

Interior cajones costilla metálicas  
*Metal interior drawers*  
 Interior gaveta com guia metálica  
*Interior calaix costella metàlica*  
 Kaxoi barnekaldea saihets metalikoekin  
*Interior caixons costela metàlica*

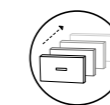

Cajón con cierre amortiguado  
*Drawer fitted with soft closing system*  
 Gaveta com sistema de corredeiras com amortecedor  
*Calaixos amb sistema de tancament suau*  
 Motelgailudun itxierazko kajoia  
*Caixón con peche amortecido*



Guías Hettich  
*Hettich drawer sliding system*  
 Guías Hettich  
*Guies Hettich*  
 Hettich gidak  
*Guies Hettich*

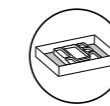

Organizador en cajón superior  
*Organizer unit on top drawer*  
 Organizador de gaveta  
*Organitzador en calaixos superiors*  
 Antolatzailea goikaldeko kajoian  
*Organizador en caixón superior*



Puerta con cierre amortiguado  
*Door with soft closing system*  
 Porta com amortecedor  
*Porta amb sistema de tancament suau*  
 Motelgailudun itxierazko atea  
*Porta con peche amortecido*



Puerta con apertura push  
*Door with push to open*  
 Porta abertura com push  
*Porta amb obertura push*  
 Push irekieradun atea  
*Porta con apertura push*



Hidrófugo  
*More resistant to water*  
 A prova d'água  
 Hidrófug  
 Hidrofugoa  
 Hidrófugo



Sistema antivaho  
*Anti fog system*  
 Sistema anti-vapor  
 Sistema antiba  
 Lurrunaren kontrako sistema  
 Sistema antivaho



Sensor de contacto On/ Off  
*Contact sensor On/ Off*  
 Sensor interruptor On/ Off  
 Sensor de contacte On/ Off  
 On/Off kontaktu sentsoarea  
 Sensor de contacto On/ Off



Reloj digital  
*Digital clock*  
 Relogio digital  
 Rellotge digital  
 Erloju digitala  
 Reloxo dixital



Luz ambiental  
*Ambient light*  
 Luz ambiente  
 Llum ambiental  
 Giro-argia  
 Luz ambiental



Reproductor musical integrado, con conexión bluetooth. 2 altavoces de 3 w cada uno.  
*Built in music player, bluetooth connection. 2 speakers of 3W each.*  
 Reproductor musical integrat, amb connexió bluetooth. 2 altavoces de 3 w cadascú.  
*Musika erreproduzizaille integratua, bluetooth konexioarekin. 3w-dun bi bozgorailu.*  
 Reproductor musical integrat, con conexión bluetooth. 2 altafalantes de 3 w cada un.

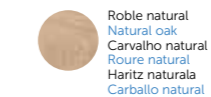

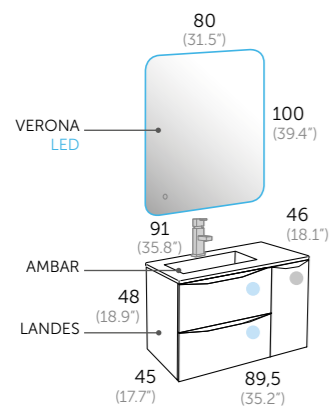

Composición **LANDES 90 (35.4")**

- 1 112 03 090 LANDES 90
- 1 506 01 092 AMBAR
- 1 246 00 100 VERONA LED

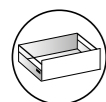

**Interior cajones costilla metálicas**  
Metal interior drawers  
Interior gaveta com guia metálica  
Interior calaix costella metàlica  
Kaxoi barnekaldea saihets metalikoekin  
Interior caixóns costela metálica



**Sistema antivaho**  
Anti fog system  
Sistema anti-vapor  
Sistema antibaf  
Lurrunaren kontrako sistema  
Sistema antivaho

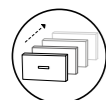

**Cajón con cierre amortiguado**  
Drawer fitted with soft closing system  
Gaveta com sistema de corrediças com amortecedor  
Calaixos amb sistema de tancament suau  
Motelgailudun itxierazko kajoia  
Caixon con peche amortecido



**Sensor de contacto On/ Off**  
Contact sensor On/ Off  
Sensor interruptor On/ Off  
Sensor de contacto On/ Off  
On/Off kontaktu sentsorea  
Sensor de contacto On/ Off



**Guías Hettich**  
Hettich drawer sliding system  
Guias Hettich  
Guias Hettich  
Hettich gidak  
Guias Hettich



**Reversible**  
It is reversible  
Reversível  
Reversible  
Itzulgarria  
Reversible



**Organizador en cajón superior**  
Organizer unit on top drawer  
Organizador de gaveta  
Organizador en calaixos superiors  
Antolatzailea goikaldeko kajoian  
Organizador en caixon superior



**Luz ambiental**  
Ambient light  
Luz ambiente  
Llum ambiental  
Giro-argia  
Luz ambiental



**Puerta con cierre amortiguado**  
Door with soft closing system  
Porta com amortecedor  
Porta amb sistema de tancament suau  
Motelgailudun itxierazko atea  
Porta con peche amortecido

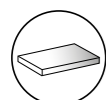

**Acabado lacado brillo**  
High gloss lacquered finish  
Cor lacado brilho  
Acabat lacat brillant  
Distiradun lakatzeko bukatua  
Acabado lacado brillo



**Hidrófugo**  
More resistant to water  
À prova d'água  
Hidrófug  
Hidrofugoa  
Hidrófugo

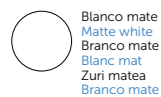

Blanco mate  
Matte white  
Branco mate  
Blanc mat  
Zuri matea  
Branco mate

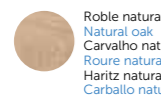

Roble natural  
Natural oak  
Carvalho natural  
Roure natural  
Haritz naturala  
Carballo natural



Gris  
Grey  
Cinzento  
Gris  
Grisa  
Gris

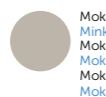

Moka  
Mink  
Moka  
Moka  
Moka



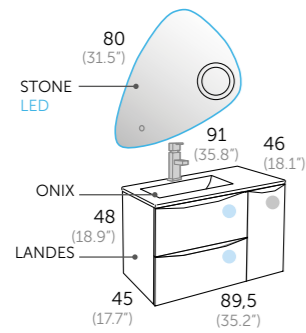

Composición **LANDES 90 (35.4")**

- 1 112 24 090 LANDES 90
- 1 500 01 091 ONIX
- 1 261 00 080 STONE LED

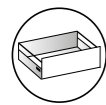

**Interior cajones costilla metálicas**  
*Metal interior drawers*  
*Interior gaveta com guia metálica*  
*Interior calaix costella metàlica*  
*Kaxoi barnekaldea saihets metalikoekin*  
*Interior caixóns costela metálica*



**Sistema antivaho**  
*Anti fog system*  
*Sistema anti-vapor*  
*Sistema antibaf*  
*Lurrunaren kontrako sistema*  
*Sistema antivaho*



**Cajón con cierre amortiguado**  
*Drawer fitted with soft closing system*  
*Gaveta com sistema de correijas com amortecedor*  
*Calaixos amb sistema de tancament suau*  
*Motelgailudun itxierazko kajoia*  
*Caixon con peche amortecido*



**Sensor de contacto On/ Off**  
*Contact sensor On/ Off*  
*Sensor interruptor On/ Off*  
*Sensor de contacte On/ Off*  
*On/Off kontaktu sentorea*  
*Sensor de contacto On/ Off*



**Guías Hettich**  
*Hettich drawer sliding system*  
*Guias Hettich*  
*Guias Hettich*  
*Hettich gidak*  
*Guias Hettich*



**Lupa aumento x3**  
*Magnifying zoom in Mirror*  
*Lupa aumento 3x*  
*Lupa augment x3*  
*3x-eko haundiagotze lupa*  
*Lupa aumento x3*

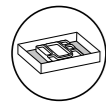

**Organizador en cajón superior**  
*Organizer unit on top drawer*  
*Organizador de gaveta*  
*Organizador en calaixos superiors*  
*Antolatzailea goikaldeko kajoian*  
*Organizador en caixon superior*

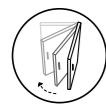

**Puerta con cierre amortiguado**  
*Door with soft closing system*  
*Porta com amortecedor*  
*Porta amb sistema de tancament suau*  
*Motelgailudun itxierazko atea*  
*Porta con peche amortecido*



**Acabado melamina con textura**  
*Textured melamine finish*  
*Cor melamina com textura*  
*Acabat melamina amb textura*  
*Testuradun melamina bukatua*  
*Acabado melamina con textura*



**Hidrófugo**  
*More resistant to water*  
*À prova d'água*  
*Hidrófug*  
*Hidrofugoa*  
*Hidrófugo*



Blanco mate  
 Matte white  
 Branco mate  
 Blanc mat  
 Zuri matea  
 Branco mate

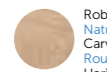

Roble natural  
 Natural oak  
 Carvalho natural  
 Roure natural  
 Haritz naturala  
 Carballo natural



Gris  
 Grey  
 Cinzento  
 Gris  
 Grisa  
 Gris

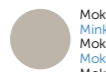



Moka  
 Mink  
 Moka  
 Moka  
 Moka  
 Moka





- 

Blanco mate  
Matte white  
Branco mate  
Blanc mat  
Zuri matea  
Branco mate
- 

Roble natural  
Natural oak  
Carvalho natural  
Roure natural  
Haritz naturala  
Carballo natural
- 

Gris  
Grey  
Cinzento  
Gris  
Grisa  
Gris
- 

Moka  
Mink  
Moka  
Moka  
Moka  
Moka

- 

Interior cajones costilla metálicas  
*Metal interior drawers*  
Interior gaveta com guia metálica  
*Interior calaix costella metàlica*  
Kaxoi barnekaldea saihets metalikoekin  
*Interior caixons costela metàlica*
- 

Cajón con cierre amortiguado  
*Drawer fitted with soft closing system*  
Gaveta com sistema de corredeiras com amortecedor  
*Calaixos amb sistema de tancament suau*  
Motelgailudun itxierazko kajoia  
*Caixon con peche amortecido*
- 

Guías Hettich  
*Hettich drawer sliding system*  
Guías Hettich  
*Guies Hettich*  
Hettich gidak  
*Guias Hettich*
- 

Organizador en cajón superior  
*Organizer unit on top drawer*  
Organizador de gaveta  
*Organizadore en calaixos superiors*  
Antolatzailea goikaldeko kajoian  
*Organizadore en caixon superior*
- 

Acabado lacado brillo  
*High gloss lacquered finish*  
Cor lacado brilho  
*Acabat lacat brillant*  
Distiradun lakatzuko bukatua  
*Acabado lacado brillo*
- 

Hidrófugo  
*More resistant to water*  
À prova d'água  
*Hidrofug*  
Hidrofugoa  
*Hidrofugo*
- 

Sistema antivaho  
*Anti fog system*  
Sistema anti-vapor  
*Sistema anti-bal*  
Lurrunaren kontrako sistema  
*Sistema antivaho*
- 

Sensor de contacto On/ Off  
*Contact sensor On/ Off*  
Sensor interruptor On/ Off  
*Sensor de contacte On/ Off*  
On/Off kontaktu sensora  
*Sensor de contacto On/ Off*
- 

Reloj digital  
*Digital clock*  
Relogio digital  
*Rellotge digital*  
Erlotzu digitala  
*Reloxo dixital*
- 

Luz ambiental  
*Ambient light*  
Luz ambiente  
*Lum ambiental*  
Giro-argia  
*Luz ambiental*
- 

Reproductor musical integrado, con conexión bluetooth. 2 altavoces de 3w cada uno.  
*Built in music player, bluetooth connection. 2 speakers of 3W each.*  
Reprodutor musical integradu, con conexao bluetooth 2 altifalantes de 3 w cada un.  
*Reprodutor musical integrat, amb connexio bluetooth. 2 altaveus de 3 w cadascu.*  
Musika erreproduzitzaiela integratua, bluetooth konexioarekin. 3w-dun bi bozgorailu.  
*Reprodutor musical integradu, con conexion bluetooth. 2 altofalantes de 3 w cada un.*

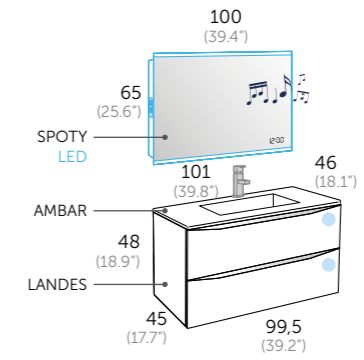

Composición **LANDES 100** (39.4")  
 1 112 16 100 LANDES 100  
 1 506 01 100 AMBAR  
 1 267 00 100 SPOTY LED



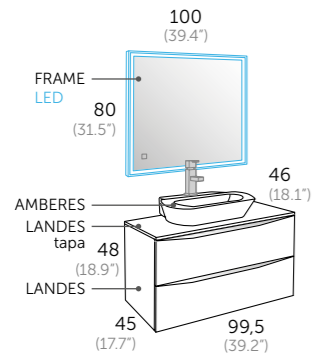

Composición **LANDES 100** (39.4")

- 1 112 35 100 LANDES 100
- 1 112 35 210 LANDES tapa
- 1 507 01 003 AMBERES
- 1 266 00 100 FRAME LED

- Blanco mate  
Matte white  
Branco mate  
Blanc mat  
Zuri matea  
Branco mate
- Roble natural  
Natural oak  
Carvalho natural  
Roure natural  
Haritz naturala  
Carballo natural
- Gris  
Grey  
Cinzento  
Gris  
Grisa  
Gris
- Moka  
Mirk  
Moka  
Moka  
Moka



Interior cajones costilla metálicas  
*Metal interior drawers*  
Interior gaveta com guia metálica  
*Interior calaix costella metálica*  
Kaxoi barnekaldea saihets metalikoekin  
*Interior caixons costela metálica*

Cajón con cierre amortiguado  
*Drawer fitted with soft closing system*  
Gaveta com sistema de corrediças com amortecedor  
*Calaixos amb sistema de tancament suau*  
Motelgailudun itxierazko kajoia  
*Caixón con peche amortecido*

Guías Hettich  
*Hettich drawer sliding system*  
Guias Hettich  
*Gues Hettich*  
Hettich gidak  
*Guias Hettich*

Organizador en cajón superior  
*Organizer unit on top drawer*  
Organizador de gaveta  
*Organitzador en calaixos superiors*  
Antolatzailea goikaldeko kajoian  
*Organizador en caixón superior*

Hidrófugo  
*More resistant to water*  
À prova d'água  
*Hidrófug*  
Hidrofugoa  
*Hidrófugo*

Sistema antivaho  
*Anti fog system*  
Sistema anti-vapor  
*Sistema antibaf*  
Lurrunaren kontrako sistema  
*Sistema antivaho*

Sensor de contacto On/ Off  
*Contact sensor On/ Off*  
Sensor interruptor On/ Off  
*Sensor de contacte On/ Off*  
On/Off kontaktu sensorea  
*Sensor de contacto On/ Off*

Reversible  
*It is reversible*  
Reversível  
*Reversible*  
Itzulgarria  
*Reversible*

Luz ambiental  
*Ambient light*  
Luz ambiente  
*Llum ambiental*  
Giro-argia  
*Luz ambiental*

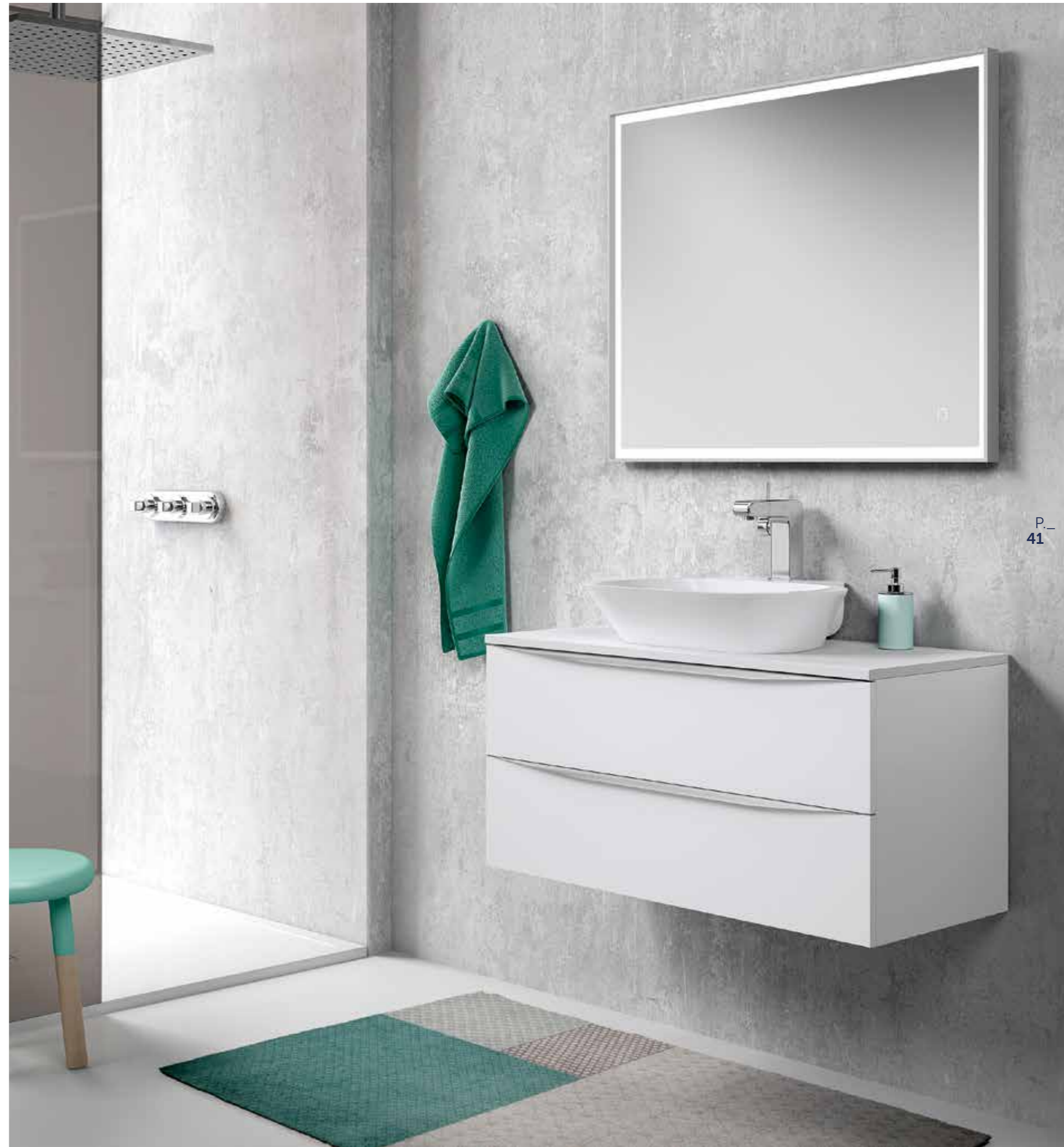

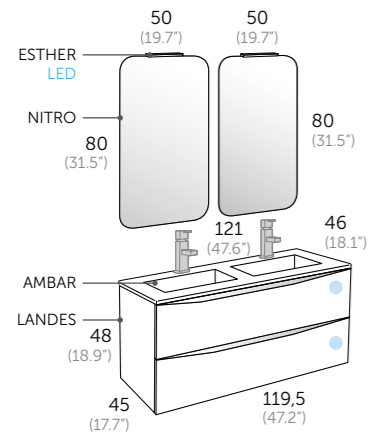

Composición **LANDES 120** (47.2")

- 1 112 24 120 LANDES 120
- 1 506 01 122 AMBAR
- 2 241 00 050 NITRO
- 2 400 00 121 ESTHER LED

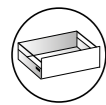

Interior cajones costilla metálicas  
*Metal interior drawers*  
 Interior gaveta com guia metálica  
*Interior calaix costella metálica*  
 Kaxoi barnekaldea saihets metalikoekin  
*Interior caixóns costela metálica*



Cajón con cierre amortiguado  
*Drawer fitted with soft closing system*  
 Gaveta com sistema de correijas com amortecedor  
*Calaixos amb sistema de tancament suau*  
 Motelgailudun itxierazko kajoia  
*Caixón con peche amortecido*



Guías Hettich  
*Hettich drawer sliding system*  
 Guías Hettich  
*Guias Hettich*  
 Hettich gidak  
*Guias Hettich*

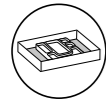

Organizador en cajón superior  
*Organizer unit on top drawer*  
 Organizador de gaveta  
*Organizador en calaixos superiors*  
 Antolatzailea goikaldeko kajoian  
*Organizador en caixón superior*

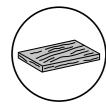

Acabado melamina con textura  
*Textured melamine finish*  
 Cor melamina con textura  
*Acabat melamina amb textura*  
 Testuradun melamina bukatua  
*Acabado melamina con textura*



Hidrófugo  
*More resistant to water*  
 A prova d'água  
*Hidrófug*  
 Hidrofúgoa  
*Hidrófugo*



Blanco mate  
*Matte white*  
 Branco mate  
*Blanc mat*  
 Zuri matea  
*Branco mate*



Roble natural  
*Natural oak*  
 Carvalho natural  
*Roure natural*  
 Haritz naturala  
*Carballo natural*



Gris  
*Grey*  
 Cinzento  
*Gris*  
 Grisa  
*Gris*



Moka  
*Mink*  
 Moka  
*Moka*  
 Moka  
*Moka*



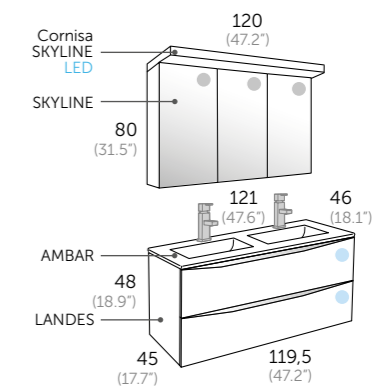

Composición **LANDES 120** (47.2")

- 1 112 16 120 LANDES 120
- 1 506 01 122 AMBAR
- 1 341 16 120 SKYLINE
- 1 341 16 121 Cornisa SKYLINE LED

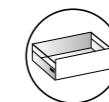

Interior cajones costilla metálica  
*Metal interior drawers*  
 Interior gaveta com guia metálica  
*Interior calaix costella metálica*  
 Kaxoi barnekaldea saihets metalikoekin  
*Interior caixóns costela metálica*

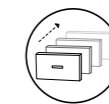

Cajón con cierre amortiguado  
*Drawer fitted with soft closing system*  
 Gaveta com sistema de corredeiras com amortecedor  
*Caixaos amb sistema de tancament suau*  
 Motelgailudun itxierazko kajoia  
*Caixón con peche amortecido*



Guías Hettich  
*Hettich drawer sliding system*  
 Guias Hettich  
*Guias Hettich*  
 Hettich gidak  
*Guias Hettich*

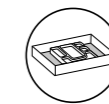

Organizador en cajón superior  
*Organizer unit on top drawer*  
 Organizador de gaveta  
*Organizador en calaixos superiors*  
 Antolatzailea goikaldeko kajoian  
*Organizador en caixón superior*



Puerta con cierre amortiguado  
*Door with soft closing system*  
 Porta com amortecedor  
 Porta amb sistema de tancament suau  
 Motelgailudun itxierazko atea  
*Porta con peche amortecido*

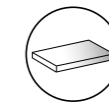

Acabado lacado brillo  
*High gloss lacquered finish*  
 Cor lacado brilho  
*Acabat lacat brillant*  
 Distiradun lakatzuko bukatua  
*Acabado lacado brillo*



Hidrófugo  
*More resistant to water*  
 À prova d'água  
 Hidrofug  
 Hidrofugoa  
 Hidrófugo

Blanco mate  
 Matte white  
 Branco mate  
 Blanc mat  
 Zuri matea  
 Branco mate

Roble natural  
 Natural oak  
 Carvalho natural  
 Roure natural  
 Haritz naturala  
 Carballo natural

Gris  
 Cinzento  
 Gris  
 Grisa  
 Gris

Moka  
 Mink  
 Moka  
 Moka  
 Moka



## LANDES\_60 (23.6")

ESPEJOS Y CAMERINOS más opciones en págs. 316 - 325

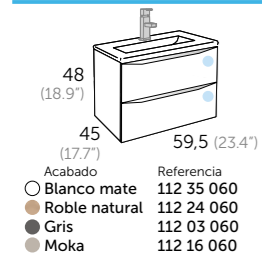

### ENCIMERAS / countertops / lavatorios / lavabos / gainekoak / encimeras



<b>ONIX</b> cerámica Referencia 500 01 060	<b>TOPACIO</b> resina Referencia 505 01 060	<b>JADE</b> masa blanca Referencia 504 01 060	<b>MASAI</b> Referencia 518 02 060 Más colores en pág. 308-311	<b>MASAI TAPA</b> Referencia 519 02 060 Más colores en pág. 313
---	--	--	--	---

## LANDES\_80 (31.5")

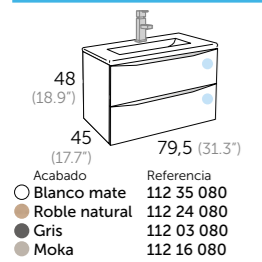

### ENCIMERAS / countertops / lavatorios / lavabos / gainekoak / encimeras



<b>ONIX</b> cerámica Referencia 500 01 080	<b>TOPACIO</b> resina Referencia 505 01 080	<b>JADE</b> masa blanca Referencia 504 01 080	<b>AMBAR</b> mate Referencia 506 01 080	<b>MASAI</b> Referencia 518 02 080 Más colores en pág. 308-311	<b>MASAI TAPA</b> Referencia 519 02 080 Más colores en pág. 313
---	--	--	--	--	---

## LANDES\_90 (35.4")

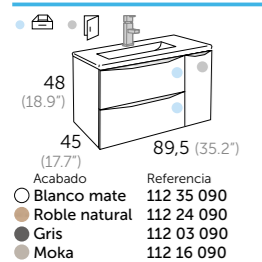

### ENCIMERAS / countertops / lavatorios / lavabos / gainekoak / encimeras



<b>ONIX</b> cerámica Referencia 500 01 091	<b>AMBAR</b> mate Referencia 506 01 092	<b>MASAI TAPA</b> Referencia 519 02 090 Más colores en pág. 313
---	--	---

## LANDES\_100 (39.4")

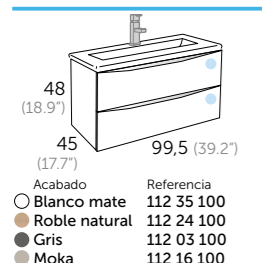

### ENCIMERAS / countertops / lavatorios / lavabos / gainekoak / encimeras



<b>ONIX</b> cerámica Referencia 500 01 100	<b>TOPACIO</b> resina Referencia 505 01 100	<b>JADE</b> masa blanca Referencia 504 01 100	<b>AMBAR</b> mate Referencia 506 01 100	<b>MASAI</b> Referencia 518 02 100 Más colores en pág. 308-311	<b>MASAI TAPA</b> Referencia 519 02 100 Más colores en pág. 313
---	--	--	--	--	---

## LANDES\_120 (47.2")

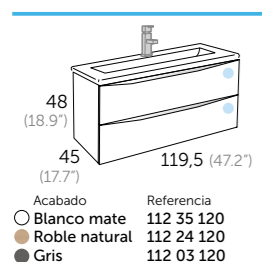

### ENCIMERAS / countertops / lavatorios / lavabos / gainekoak / encimeras



<b>ONIX</b> cerámica Referencia 500 01 120	<b>ONIX</b> cerámica Referencia 500 01 122	<b>TOPACIO</b> Referencia 505 01 120	<b>TOPACIO</b> Referencia 505 01 122	<b>AMBAR</b> Referencia 506 01 120	<b>AMBAR</b> Referencia 506 01 122	<b>MASAI</b> Referencia 518 02 122 Más colores en pág. 308-311	<b>MASAI TAPA</b> Referencia 519 02 120 Más colores en pág. 313
---	---	---	---	---------------------------------------	---------------------------------------	--	---

## LANDES TAPA

Fabricadas en MDF hidrófugo y chapadas con laser. Las tapas se sirven sin agujero.

Blanco mate		Roble natural	
Medida	Referencia	Medida	Referencia
60 x 45	112 35 206	60 x 45	112 24 206
80 x 45	112 35 208	80 x 45	112 24 208
90 x 45	112 35 209	90 x 45	112 24 209
100 x 45	112 35 210	100 x 45	112 24 210
120 x 45	112 35 212	120 x 45	112 24 212

### LAVABOS / washbasins / lavatorio pousar / lavabo sobreposar / gainjarritako konketa / lavabo sobrepoñer

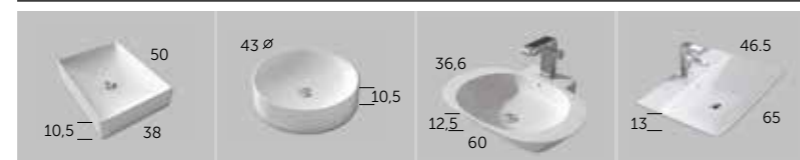

<b>ESTAMBUL</b> Referencia 507 01 005 Altura 10,5 cm	<b>ROTTERDAM</b> Referencia 507 01 004 Altura 10,5 cm	<b>AMBERES</b> Referencia 507 01 003 Altura 12,5	<b>LANDES</b> Referencia 507 01 002 Altura 13
--	---	--	---

más opciones en págs. 314 - 315

### ESPEJOS / mirrors / espelhos / miralls / ispi luak / espellos

### CAMERINOS / armoirs / armário com espelho / camerinos kamerinoak / camerinos /

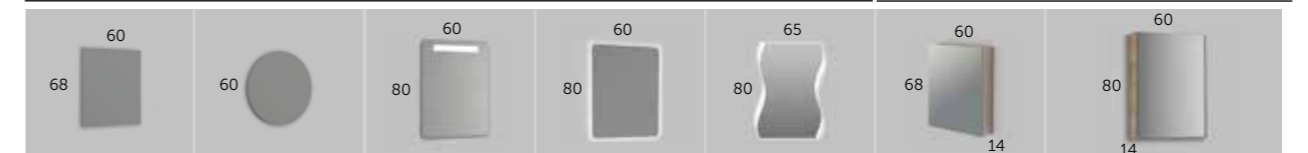

<b>MOON</b> Referencia 200 00 060	<b>REDONDO</b> Referencia 244 00 060	<b>RAIN LED</b> Referencia 269 00 060	<b>VERONA LED</b> Referencia 246 00 060	<b>MÓDENA LED</b> Referencia 264 00 080	<b>FLASH</b> Referencia 340 11 060	<b>SKYLINE</b> Referencia 341 24 060 Más colores en pág. 323
--------------------------------------	---	--	--	--	---------------------------------------	--

### ESPEJOS / mirrors / espelhos / miralls / ispi luak / espellos

### CAMERINOS / armoirs / armário com espelho / camerinos kamerinoak / camerinos /



<b>MOON</b> Referencia 200 00 080	<b>SIGMA</b> Referencia 290 00 080	<b>VERONA LED</b> Referencia 246 00 100	<b>HOLMES LED</b> Referencia 263 00 080	<b>TOWER LED</b> Referencia 262 00 080	<b>SPOTY LED</b> Referencia 267 00 080	<b>FLASH</b> Referencia 340 11 080	<b>SKYLINE</b> Referencia 341 24 080 Más colores en pág. 323
--------------------------------------	---------------------------------------	--	--	---	---	---------------------------------------	--

### ESPEJOS / mirrors / espelhos / miralls / ispi luak / espellos

### CAMERINOS / armoirs / armário com espelho / camerinos kamerinoak / camerinos /

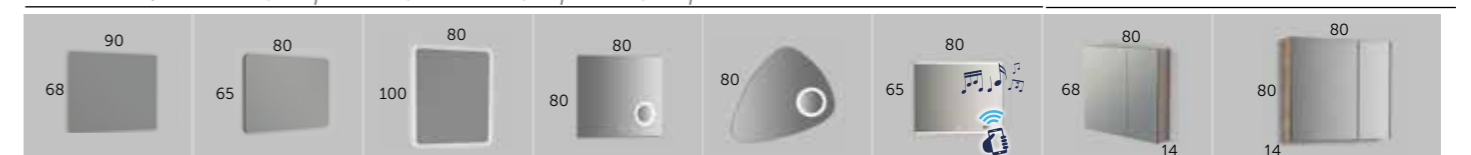

<b>MOON</b> Referencia 200 00 090	<b>SIGMA</b> Referencia 290 00 080	<b>VERONA LED</b> Referencia 246 00 100	<b>HOLMES LED</b> Referencia 263 00 080	<b>STONE LED</b> Referencia 261 00 080	<b>SPOTY LED</b> Referencia 267 00 080	<b>FLASH</b> Referencia 340 11 080	<b>SKYLINE</b> Referencia 341 24 080 Más colores en pág. 323
--------------------------------------	---------------------------------------	--	--	---	---	---------------------------------------	--

### ESPEJOS / mirrors / espelhos / miralls / ispi luak / espellos

### CAMERINOS

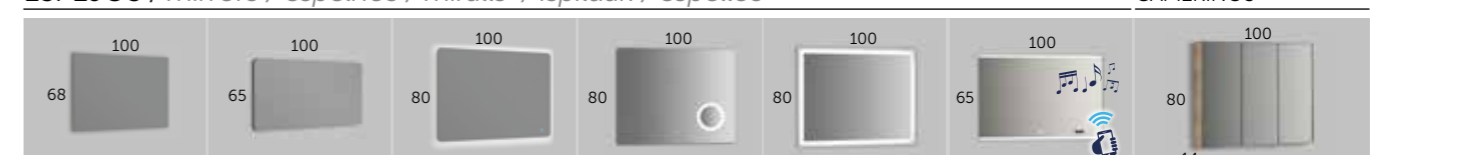

<b>MOON</b> Referencia 200 00 100	<b>SIGMA</b> Referencia 290 00 100	<b>VERONA LED</b> Referencia 246 00 100	<b>HOLMES LED</b> Referencia 263 00 100	<b>FRAME LED</b> Referencia 266 00 100	<b>SPOTY LED</b> Referencia 267 00 100	<b>SKYLINE</b> Referencia 341 24 100 Más colores en pág. 323
--------------------------------------	---------------------------------------	--	--	---	---	--

### ESPEJOS / mirrors / espelhos / miralls / ispi luak / espellos

### CAMERINOS / armoirs / armário com espelho / camerinos kamerinoak / camerinos /



<b>MOON</b> Referencia 200 00 120	<b>SIGMA</b> Referencia 290 00 120	<b>NITRO</b> Referencia 241 00 050	<b>RAIN LED</b> Referencia 269 00 120	<b>FLASH</b> Referencia 340 11 060	<b>SKYLINE</b> Referencia 341 24 120 Más colores en pág. 323
--------------------------------------	---------------------------------------	---------------------------------------	--	---------------------------------------	--

## APLIQUES

Página 326

### AUXILIARES / auxiliary units / auxiliares / auxiliars / osagarriak / auxiliares

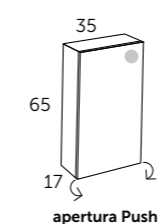

**LANDES** colgar izda./dcha.

Acabado	Referencia
Blanco mate	112 35 435
Roble natural	112 24 435
Gris	112 03 435
Moka	112 16 435

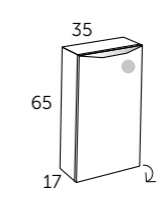

**LANDES** bajo columna izda.

Acabado	Referencia
Blanco mate	112 35 036
Roble natural	112 24 036
Gris	112 03 036
Moka	112 16 036

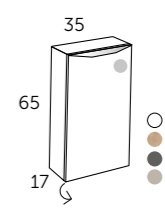

**LANDES** bajo columna dcha.

Acabado	Referencia
Blanco mate	112 35 035
Roble natural	112 24 035
Gris	112 03 035
Moka	112 16 035

# Landes modular

Sigma  
Omega  
Landes  
**Landes modular**  
Strip  
Cairo  
Dúo  
Ikaro  
Denim  
Lip  
Wave  
Sky  
Trent  
Escorpio  
Tauro  
Wood  
Mar  
Hole  
Aries  
Galsaky  
Small  
Homy  
Comet  
Tívoli  
Moon  
Dominó

80/90/100/110/120/140/  
150/160/180/200



# encimera\_Ambar 80/90/100/110/120

Blanco mate  
Matte white  
Branco mate  
Blanc mat  
Zuri matea  
Branco mate

Roble natural  
Natural oak  
Carvalho natural  
Roure natural  
Haritz naturala  
Carballo natural

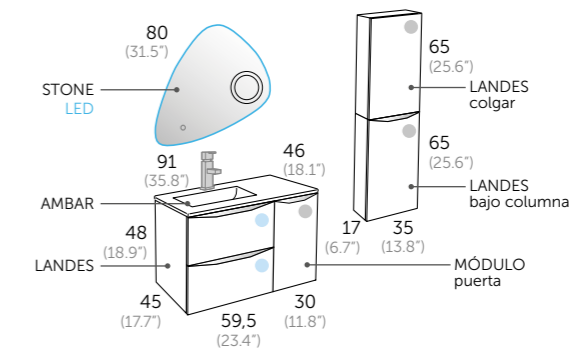

### Composición LANDES Ambar 90 (35.4')

- 1 112 35 060 LANDES 60
- 1 112 35 030 MÓDULO puerta dcha.
- 1 506 01 091 AMBAR
- 1 261 00 080 STONE LED

### Auxiliares

- 1 112 35 435 LANDES colgar
- 1 112 35 035 LANDES bajo columna dcha.

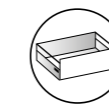

Interior cajones costilla metálicas  
*Metal interior drawers*  
Interior gaveta com guia metálica  
*Interior calaix costella metálica*  
Kaxoi barnekaldea saihets metalikoekin  
*Interior caixóns costela metálica*

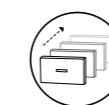

Cajón con cierre amortiguado  
*Drawer fitted with soft closing system*  
Gaveta com sistema de corredeiras com amortecedor  
*Calaixos amb sistema de tancament suau*  
Motelgailudun itxierazko kajoia  
*Caixón con peche amortecido*



Guías Hettich  
*Hettich drawer sliding system*  
Guías Hettich  
*Guies Hettich*  
Hettich gidak  
*Guías Hettich*

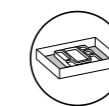

Organizador en cajón superior  
*Organizer unit on top drawer*  
Organizador de gaveta  
*Organizador en calaixos superiors*  
Antolatzailea goikaldeko kajoian  
*Organizador en caixón superior*



Puerta con apertura push  
*Door with push to open*  
Porta abertura com push  
*Porta amb obertura push*  
Push irekieradun atea  
*Porta con apertura push*



Puerta con cierre amortiguado  
*Door with soft closing system*  
Porta com amortecedor  
*Porta amb sistema de tancament suau*  
Motelgailudun itxierazko atea  
*Porta con peche amortecido*



Hidrófugo  
*More resistant to water*  
À prova d'água  
*Hidrofulg*  
Hidrofulgoa  
*Hidrofulgo*



Sistema antivaho  
*Anti fog system*  
Sistema anti-vapor  
*Sistema antibaf*  
Lurrunaren kontrako sistema  
*Sistema antivaho*



Sensor de contacto On/ Off  
*Contact sensor On/ Off*  
Sensor interruptor On/ Off  
*Sensor de contacte On/ Off*  
On/Off kontaktu sentsorea  
*Sensor de contacto On/ Off*



Lupa aumento x3  
*Magnifying zoom in Mirror*  
Lupa aumento 3x  
*Lupa augment 3x*  
3x-eko haundiagotze lupa  
*Lupa aumento 3x*

# encimera Ambar



- Blanco mate  
Matte white  
Branco mate
- Roble natural  
Natural oak  
Carvalho natural
- Blanc mat  
Haritz naturala  
Carballo natural
- Zuri matea  
Branco mate

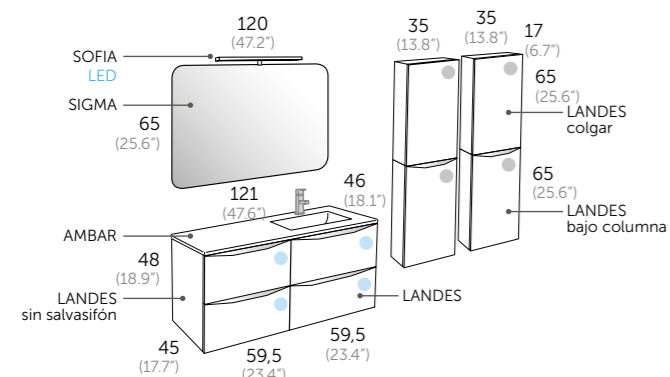

## Composición LANDES Ambar 120 (47.2")

- 1 112 35 060 LANDES 60
- 1 112 35 061 LANDES 60 (sin salvasifón)
- 1 506 01 123 AMBAR
- 1 290 00 120 SIGMA
- 1 400 00 141 SOFIA LED

## Auxiliares

- 2 112 35 435 LANDES colgar
- 2 112 35 035 LANDES bajo columna dcha.

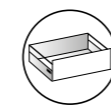
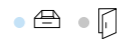

Interior cajones costilla metálicas  
*Metal interior drawers*  
Interior gaveta con guía metálica  
*Interior calaix costella metàlica*  
Kaxoi barnekaldea saihets metalikoekin  
*Interior caixóns costela metálica*

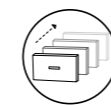

Cajón con cierre amortiguado  
*Drawer fitted with soft closing system*  
Gaveta com sistema de corredeiras com amortecedor  
*Calaixos amb sistema de tancament suau*  
Motelgailudun itxierazko kajoia  
*Caixón con peche amortecido*



Guías Hettich  
*Hettich drawer sliding system*  
Guias Hettich  
*Hettich gidak*  
Guías Hettich

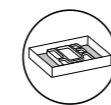

Organizador en cajón superior  
*Organizer unit on top drawer*  
Organizador de gaveta  
*Organizador en calaixos superiors*  
Antolatzailea goikaldeko kajoian  
*Organizador en caixón superior*



Puerta con apertura push  
*Door with push to open*  
Porta abertura com push  
*Porta amb obertura push*  
Push irekieradun atea  
*Porta con apertura push*



Puerta con cierre amortiguado  
*Door with soft closing system*  
Porta com amortecedor  
*Porta amb sistema de tancament suau*  
Motelgailudun itxierazko atea  
*Porta con peche amortecido*

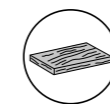

Acabado melamina con textura  
*Textured melamine finish*  
Cor melamina com textura  
*Acabat melamina amb textura*  
Testuradun melanina bukatua  
*Acabado melanina con textura*



Hidrófugo  
*More resistant to water*  
À prova d'água  
*Hidrófug*  
Hidrófugo

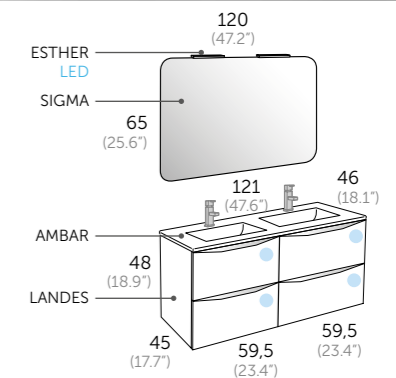

## Composición LANDES Ambar 120 (47.2")

- 2 112 24 060 LANDES 60
- 1 506 01 122 AMBAR
- 1 290 00 120 SIGMA
- 2 400 00 121 ESTHER LED



# 100/110/120/140/150/160/180/200 **Sobreponer**

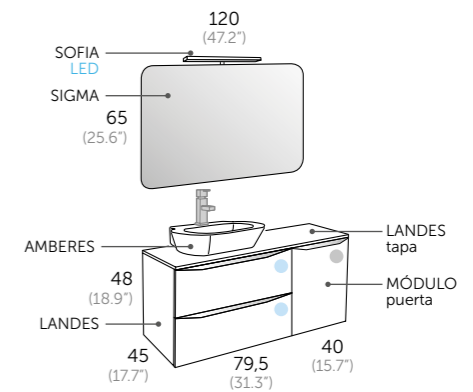
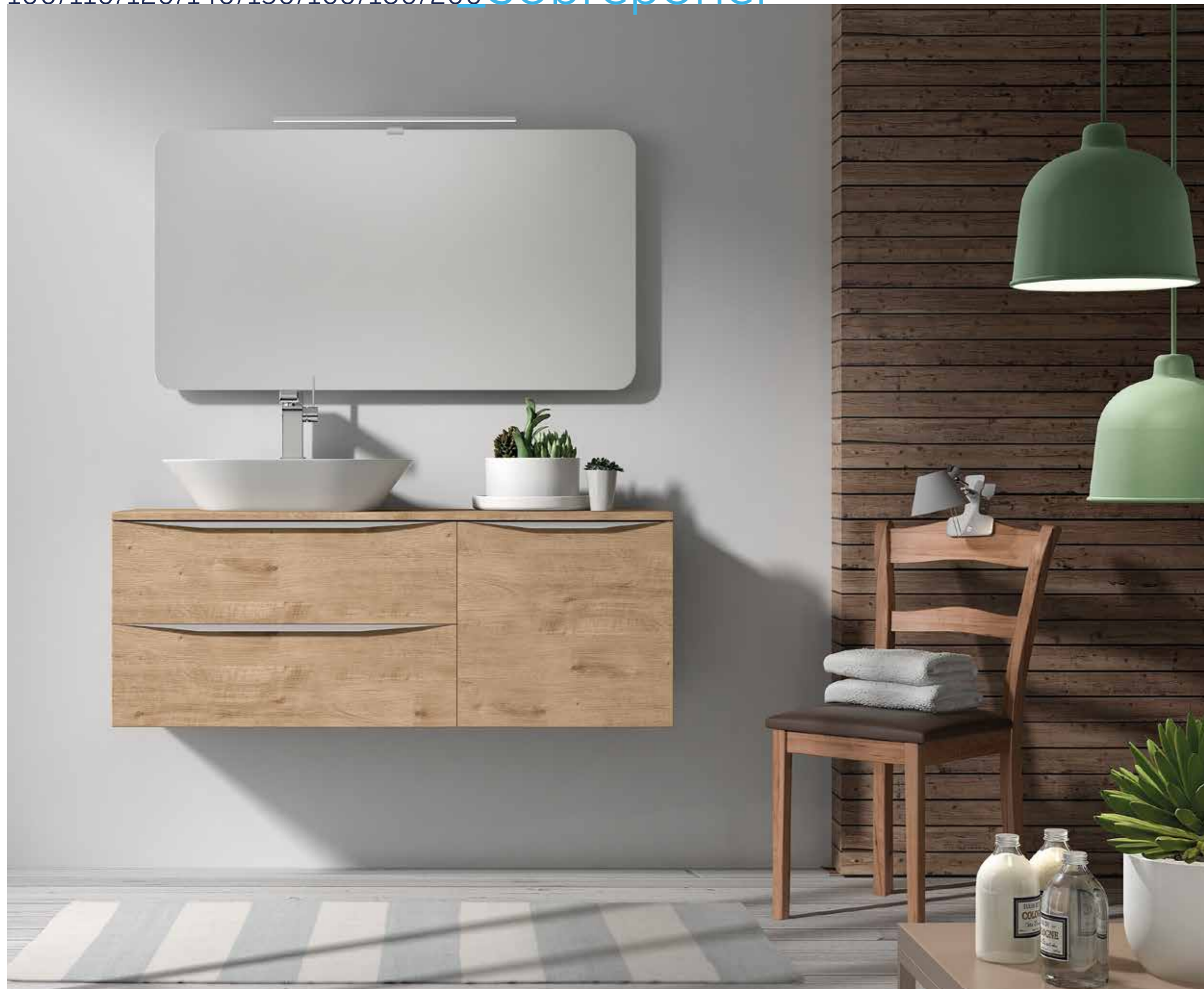

## Composición **LANDES** sobreponer **120** (47.2")

- 1 112 24 080 LANDES 80
- 1 112 24 040 MÓDULO puerta dcha.
- 1 112 24 212 LANDES tapa
- 1 507 01 003 AMBERES
- 1 290 00 120 SIGMA
- 1 400 00 141 SOFIA LED

- Blanco mate  
Matte white  
Branco mate  
Blanc mat  
Zuri matea  
Branco mate
- Roble natural  
Natural oak  
Carvalho natural  
Roure natural  
Haritz naturala  
Carballo natural

-  Interior cajones costilla metálicas  
*Metal interior drawers*  
Interior gaveta com guia metálica  
Interior calaix costella metàlica  
Kaxoi barnekaldea saihets metalikoekin  
Interior caixóns costela metálica
-  Cajón con cierre amortiguado  
*Drawer fitted with soft closing system*  
Gaveta com sistema de corredeças com amortecedor  
Calaixos amb sistema de tancament suau  
Motelgailudun itxierazko kajoia  
Caijón con peche amortecido
-  Guías Hettich  
*Hettich drawer sliding system*  
Guias Hettich  
Guias Hettich  
Hettich gidak  
Guias Hettich
-  Organizador en cajón superior  
*Organizer unit on top drawer*  
Organizador de gaveta  
Organizador en calaixos superiors  
Antolatzailea goikaldeko kajoian  
Organizador en caixón superior
-  Puerta con cierre amortiguado  
*Door with soft closing system*  
Porta com amortecedor  
Porta amb sistema de tancament suau  
Motelgailudun itxierazko atea  
Porta con peche amortecido
-  Acabado melamina con textura  
*Textured melamine finish*  
Cor melamina com textura  
Acabat melamina amb textura  
Testuradun melanina bukatua  
Acabado melanina con textura
-  Hidrófugo  
*More resistant to water*  
À prova d'água  
Hidrófugo  
Hidrofugoa  
Hidrófugo

# Sobreponer



- Blanco mate  
Matte white  
Branco mate  
Blanc mat  
Zuri matea  
Branco mate
- Roble natural  
Natural oak  
Carvalho natural  
Roire natural  
Haritz naturala  
Carballo natural

- 

Organizador en cajón superior  
Organizer unit on top drawer  
Organizador de gaveta  
Organizador en caixos superiores  
Antolatzailea goikaldeko kajoian  
Organizador en caixon superior
- 

Interior cajones costilla metálica  
Metal interior drawers  
Interior gaveta com guia metálica  
Interior calaix costella metálica  
Kaxoi barnekaldea sailhets metalikoekin  
Interior caixóns costela metálica
- 

Cajón con cierre amortiguado  
Drawer fitted with soft closing system  
Gaveta com sistema de correijas com amortecedor  
Calaixos amb sistema de tancament suau  
Motelgailudun itxierazko kajoia  
Caixon con peche amortecido
- 

Acabado melamina con textura  
Textured melamine finish  
Cor melamina com textura  
Acabat melamina amb textura  
Testuradun melanina bukatua  
Acabado melanina con textura
- 

Hidrófugo  
More resistant to water  
À prova d'água  
Hidrófug  
Hidrofuogo  
Hidrófugo

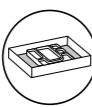
- 

Puerta con cierre amortiguado  
Door with soft closing system  
Porta com amortecedor  
Porta amb sistema de tancament suau  
Motelgailudun itxierazko atea  
Porta con peche amortecido

- 

Reversible  
It is reversible  
Reversível  
Reversible  
Itzulgarria  
Reversible

- 

Luz ambiental  
Ambient light  
Luz ambiente  
Lum ambiental  
Giro-argia  
Luz ambiental

- 

Sistema antivaho  
Anti fog system  
Sistema anti-vapor  
Sistema antibaf  
Lurrunaren kontrako sistema  
Sistema antivaho

- 

Sensor de contacto On/ Off  
Contact sensor On/ Off  
Sensor interruptor On/ Off  
Sensor de contacte On/ Off  
On/Off kontaktu sentsoarea  
Sensor de contacto On/ Off

- 

Reversible  
It is reversible  
Reversível  
Reversible  
Itzulgarria  
Reversible

- 

Luz ambiental  
Ambient light  
Luz ambiente  
Lum ambiental  
Giro-argia  
Luz ambiental

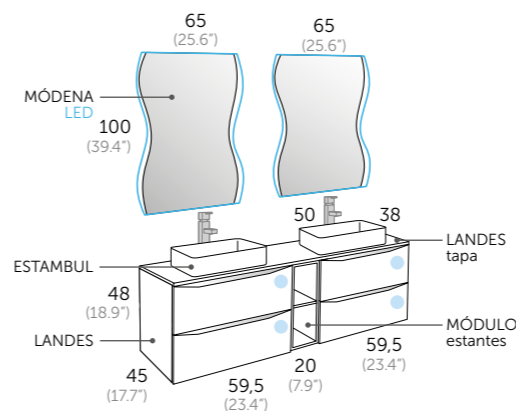

Composición **LANDES** sobreponer **140 (55")**

- 2 112 35 060 LANDES 60
- 1 112 35 022 MÓDULO estantes
- 1 112 35 214 LANDES tapa
- 2 507 01 005 ESTAMBUL
- 2 264 00 100 MÓDENA LED

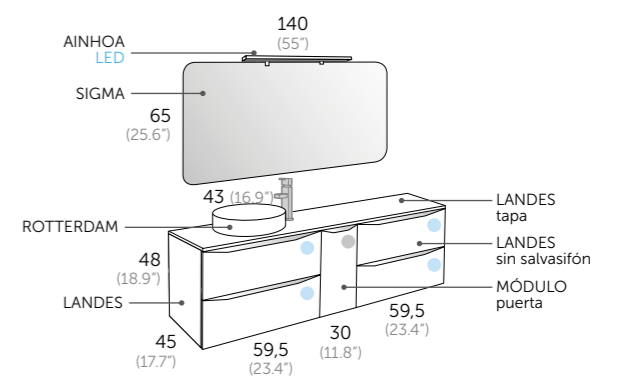

Composición **LANDES** sobreponer **150 (59")**

- 1 112 24 060 LANDES 60
- 1 112 24 061 LANDES 60 sin salvafisión
- 1 112 24 030 MÓDULO puerta dcha.
- 1 112 24 215 LANDES tapa
- 1 507 01 004 ROTTERDAM
- 1 290 00 140 SIGMA
- 1 400 00 151 AINHOA LED



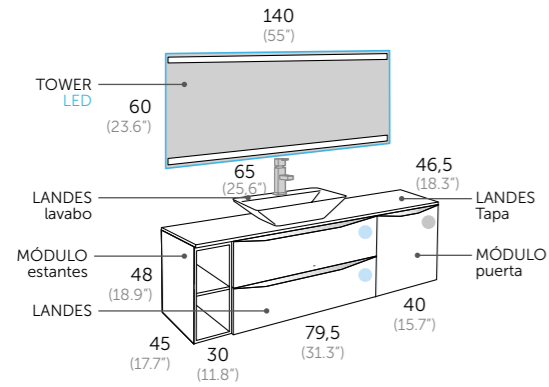

Composición **LANDES sobreponer 150 (59")**

- 1 112 35 080 LANDES 80
- 1 112 35 000 MÓDULO estantes
- 1 112 24 040 MÓDULO puerta dcha.
- 1 112 35 215 LANDES tapa
- 1 507 01 002 LANDES lavabo
- 1 262 00 140 TOWER LED

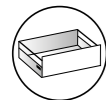

Interior cajones costilla metálicas  
Metal interior drawers  
Interior gaveta com guia metálica  
Interior calaix costella metàlica  
Kaxoi barnekaldea saihets metalikoekin  
Interior caixons costela metalica

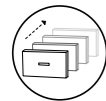

Cajón con cierre amortiguado  
Drawer fitted with soft closing system  
Gaveta com sistema de correções com amortecedor  
Calaixos amb sistema de tancament suau  
Motelgailudun itxierazko kajoia  
Caixón con peche amortecido



Guías Hettich  
Hettich drawer sliding system  
Guias Hettich  
Guias Hettich  
Hettich gidak  
Guias Hettich



Organizador en cajón superior  
Organizer unit on top drawer  
Organizador de gaveta  
Organitzador en calaixos superiors  
Antolatzailea goikaldeko kajoian  
Organizador en caixon superior

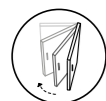

Puerta con cierre amortiguado  
Door with soft closing system  
Porta com amortecedor  
Porta amb sistema de tancament suau  
Motelgailudun itxierazko atea  
Porta con peche amortecido



Acabado melamina con textura  
Textured melamine finish  
Cor melamina com textura  
Acabat melamina amb textura  
Testuradun melanina bukatua  
Acabado melanina con textura



Hidrófugo  
More resistant to water  
A prova d'água  
Hidrofug  
Hidrofugoa  
Hidrofugo



Sistema antivaho  
Anti fog system  
Sistema anti-vapor  
Sistema antibaf  
Lurrunaren kontrako sistema  
Sistema antivaho



Sensor infrarrojo On/Off  
Infrared sensor On/Off  
Sensor infravermelho On/ Off  
Sensor infraroig On/ Off  
On/Off sentzore infragorria  
Sensor infravermello On/Off



Reversible  
It is reversible  
Reversível  
Reversible  
Itzulgarria  
Reversible

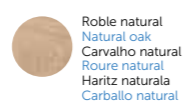

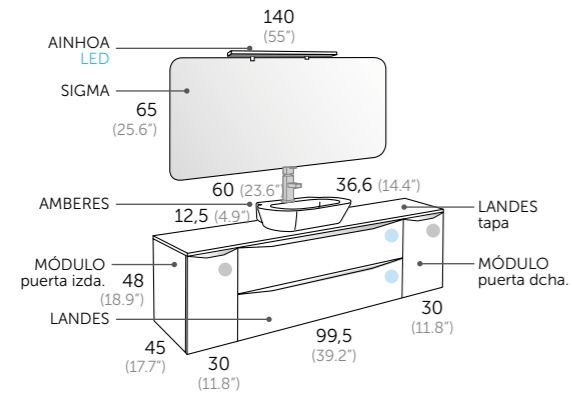

## Composición **LANDES** sobreponer **160** (63")

- 1 112 24 100 LANDES 100
- 1 112 24 030 MÓDULO puerta dcha.
- 1 112 24 031 MÓDULO puerta izda.
- 1 112 24 216 LANDES tapa
- 1 507 01 003 AMBERES
- 1 290 00 140 SIGMA
- 1 400 00 151 AINHOA LED

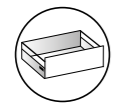

Interior cajones costilla metálicas  
*Metal interior drawers*  
 Interior gaveta com guia metálica  
*Interior calaix costella metàl·lica*  
 Kaxoi barnekaldea saihets metalikoeekin  
*Interior caixóns costela metàl·lica*



Cajón con cierre amortiguado  
*Drawer fitted with soft closing system*  
 Gaveta com sistema de corrediças com amortecedor  
*Calaixos amb sistema de tancament suau*  
 Motelgailudun itxierazko kajoia  
*Caixón con peche amortecido*



Guías Hettich  
*Hettich drawer sliding system*  
 Guías Hettich  
*Guias Hettich*  
 Hettich gidak  
*Guías Hettich*



Organizador en cajón superior  
*Organizer unit on top drawer*  
 Organizador de gaveta  
*Organitzador en calaixos superiors*  
 Antolatzaila goikaldeko kajoian  
*Organizador en caixón superior*



Puerta con cierre amortiguado  
*Door with soft closing system*  
 Porta com amortecedor  
 Porta amb sistema de tancament suau  
 Motelgailudun itxierazko atea  
*Porta con peche amortecido*



Acabado melamina con textura  
*Textured melamine finish*  
 Cor melamina com textura  
*Acabat melamina amb textura*  
 Testuradun melamina bukatua  
*Acabado melamina con textura*



Hidrófugo  
*More resistant to water*  
 À prova d'água  
 Hidrófug  
 Hidrófuga  
 Hidrófugo

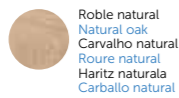



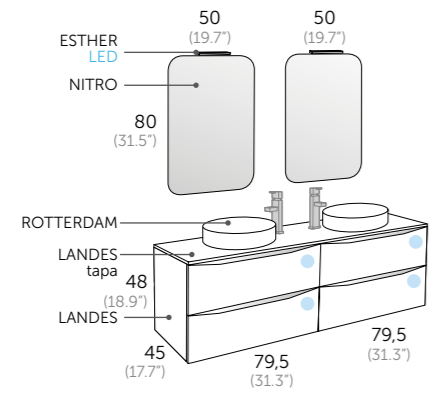

## Composición **LANDES sobreponer 160 (63")**

2	112 24 080	LANDES 80
1	112 24 216	LANDES tapa
2	507 01 004	ROTTERDAM
2	241 00 050	NITRO
2	400 00 121	ESTHER LED

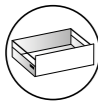

Interior cajones costilla metálicas  
*Metal interior drawers*  
Interior gaveta con guía metálica  
*Interior calaix costella metálica*  
Kaxoi barnekaldea sailhets metalikoekin  
*Interior caixóns costela metálica*



Cajón con cierre amortiguado  
*Drawer fitted with soft closing system*  
Gaveta com sistema de correções com amortecedor  
*Caixaos amb sistema de tancament suau*  
Motelgailudun itxierazko kajoia  
*Caixón con peche amortecido*



Guías Hettich  
*Hettich drawer sliding system*  
Guías Hettich  
*Guiies Hettich*  
Hettich gidak  
*Guiias Hettich*

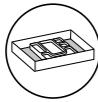

Organizador en cajón superior  
*Organizer unit on top drawer*  
Organizador de gaveta  
*Organizador en calaixos superiors*  
Antolatzailea goikaldeko kajoian  
*Organizador en caixón superior*



Acabado melamina con textura  
*Textured melamine finish*  
Cor melamina con textura  
*Acabat melamina amb textura*  
Testuradun melamina bukatua  
*Acabado melamina con textura*



Hidrófugo  
*More resistant to water*  
À prova d'água  
*Hidrófug*  
Hidrofugoa  
*Hidrófugo*

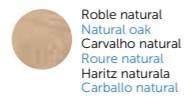

# Landes\_modular

## LANDES\_60 (23.6")

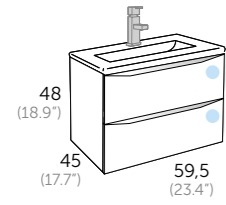

**LANDES 60**  
con salvafón

Acabado Referencia  
○ Blanco mate 112 35 060  
● Roble natural 112 24 060

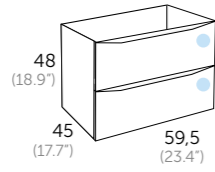

**LANDES 60**  
sin salvafón

Acabado Referencia  
○ Blanco mate 112 35 061  
● Roble natural 112 24 061

## LANDES\_80 (31.5")

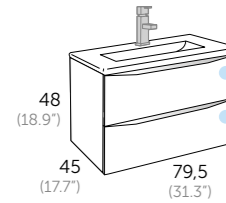

**LANDES 80**  
con salvafón

Acabado Referencia  
○ Blanco mate 112 35 080  
● Roble natural 112 24 080

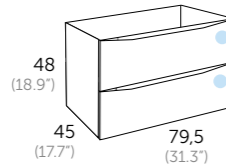

**LANDES 80**  
sin salvafón

Acabado Referencia  
○ Blanco mate 112 35 081  
● Roble natural 112 24 081

## LANDES\_100 (39.4")

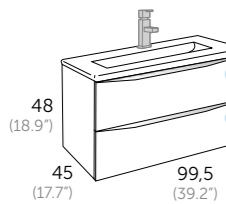

**LANDES 100**  
con salvafón

Acabado Referencia  
○ Blanco mate 112 35 100  
● Roble natural 112 24 100

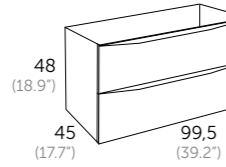

**LANDES 100**  
sin salvafón

Acabado Referencia  
○ Blanco mate 112 35 101  
● Roble natural 112 24 101

## LANDES\_120 (47.2")

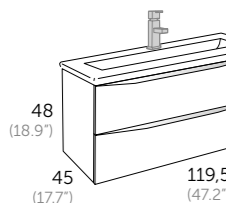

**LANDES 120**  
con salvafón

Acabado Referencia  
○ Blanco mate 112 35 120  
● Roble natural 112 24 120

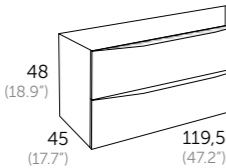

**LANDES 120**  
sin salvafón

Acabado Referencia  
○ Blanco mate 112 35 121  
● Roble natural 112 24 121

## MÓDULOS / module / modulo / mòduls / modulua / módulo

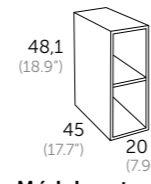

**Módulo estantes 20**

Acabado Referencia  
○ Blanco mate 112 35 022  
● Roble natural 112 24 022

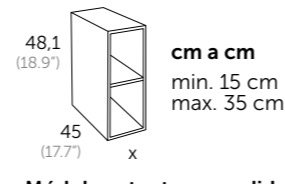

**Módulo estantes a medida**

cm a cm  
min. 15 cm  
max. 35 cm

Acabado Referencia  
○ Blanco mate 112 35 000  
● Roble natural 112 24 000

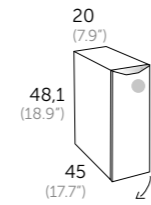

**Módulo izda. 20**

Acabado Referencia  
○ Blanco mate 112 35 021  
● Roble natural 112 24 021

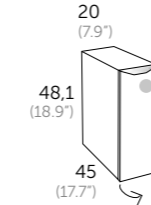

**Módulo dcha. 20**

Acabado Referencia  
○ Blanco mate 112 35 020  
● Roble natural 112 24 020

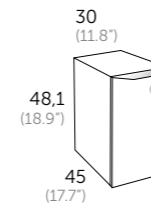

**Módulo izda. 30**

Acabado Referencia  
○ Blanco mate 112 35 031  
● Roble natural 112 24 031

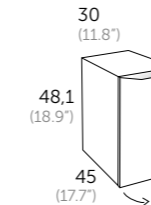

**Módulo dcha. 30**

Acabado Referencia  
○ Blanco mate 112 35 030  
● Roble natural 112 24 030

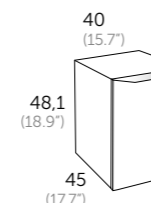

**Módulo izda. 40**

Acabado Referencia  
○ Blanco mate 112 35 041  
● Roble natural 112 24 041

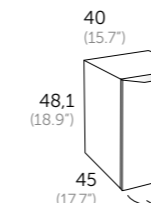

**Módulo dcha. 40**

Acabado Referencia  
○ Blanco mate 112 35 040  
● Roble natural 112 24 040

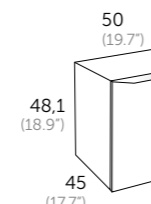

**Módulo izda. 50**

Acabado Referencia  
○ Blanco mate 112 35 051  
● Roble natural 112 24 051

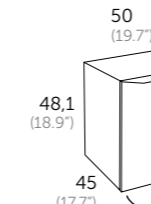

**Módulo dcha. 50**

Acabado Referencia  
○ Blanco mate 112 35 050  
● Roble natural 112 24 050

## ENCIMERAS\_Ambar / countertops / lavatorios / lavabos / gainekoak / encimeras

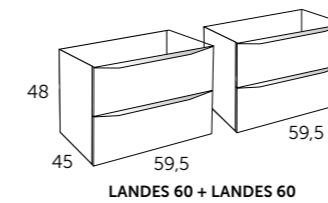

LANDES 60 + LANDES 60



AMBAR 120

Medida	Referencia
120 (2 senos)	506 01 122
120 (1 s.) izda.	506 01 121
120 (1 s.) dcha.	506 01 123

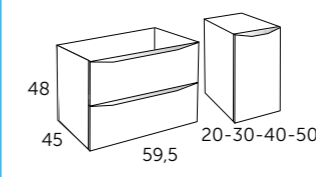

LANDES 60 + MÓDULO



AMBAR DESPLAZADA

IZDA.		DCHA.	
Medida	Referencia	Medida	Referencia
80 (60+20)	506 01 081	80 (60+20)	506 01 083
90 (60+30)	506 01 091	90 (60+30)	506 01 093
100 (60+40)	506 01 101	100 (60+40)	506 01 103
110 (60+50)	506 01 111	110 (60+50)	506 01 113

## LANDES TAPA\_sobreponer

tops / tampos / tapes / eztalkiak / tapas

Fabricadas en MDF hidrófugo y chapadas con laser.  
Las tapas se sirven sin agujero.



Blanco mate		Roble natural	
Medida	Referencia	Medida	Referencia
60 x 45	112 35 206	60 x 45	112 24 206
80 x 45	112 35 208	80 x 45	112 24 208
90 x 45	112 35 209	90 x 45	112 24 209
100 x 45	112 35 210	100 x 45	112 24 210
110 x 45	112 35 211	110 x 45	112 24 211
120 x 45	112 35 212	120 x 45	112 24 212
130 x 45	112 35 213	130 x 45	112 24 213
140 x 45	112 35 214	140 x 45	112 24 214
150 x 45	112 35 215	150 x 45	112 24 215
160 x 45	112 35 216	160 x 45	112 24 216
180 x 45	112 35 218	180 x 45	112 24 218
200 x 45	112 35 220	200 x 45	112 24 220
x cm lineal	112 35 999	x cm lineal	112 24 999

## MASAI TAPA\_sobreponer

tops / tampos / tapes / eztalkiak / tapas

Hecho de carga mineral recubierto de poliuretano acrílico.  
Las tapas se sirven sin agujero.



Negro	
Medida	Referencia
Masai 60	519 02 060
Masai 80	519 02 080
Masai 90	519 02 090
Masai 100	519 02 100
Masai 105	519 02 105
Masai 120	519 02 120
Masai 140	519 02 140
Masai 150	519 02 150
Masai 160	519 02 160
Masai 180	519 02 180
Masai 200	519 02 200

Más colores en pág. 313

## LAVABOS\_sobreponer

washbasins / lavatorio posuar / lavabo sobreposar / gainjarritako konketa / lavabo sobrepoñer



**ROTTERDAM**  
cerámica

Referencia 507 01 004  
Altura: 10,5 cm



**ESTAMBUL**  
cerámica

Referencia 507 01 005  
Altura: 10,5 cm



**AMBERES**  
cerámica

Referencia 507 01 003  
Altura: 12,5 cm



**LANDES**  
cerámica

Referencia 507 01 002  
Altura: 13 cm

## APLIQUES / más opciones página 326



**ESTHER LED**  
Referencia 400 00 121  
luz fría  
400 00 221  
luz cálida



**SOFIA LED**  
Referencia 400 00 141  
luz fría  
400 00 241  
luz cálida

## ESPEJOS / mirrors / espelhos / miralls / ispiluak / espellos

en páginas 316 - 325

## AUXILIARES / auxiliary units / auxiliars / auxiliars / osagarriak / auxiliares

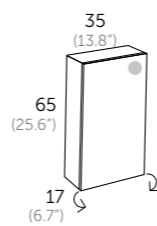

**LANDES**  
colgar izda./dcha.

Acabado Referencia  
○ Blanco mate 112 35 435  
● Roble natural 112 24 435

Push to open

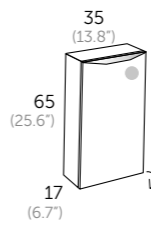

**LANDES**  
bajo columna izda.

Acabado Referencia  
○ Blanco mate 112 35 036  
● Roble natural 112 24 036

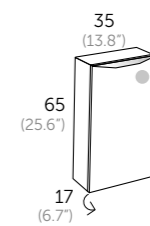

**LANDES**  
bajo columna dcha.

Acabado Referencia  
○ Blanco mate 112 35 035  
● Roble natural 112 24 035

80/100/120

# Strip

Sigma  
Omega  
Landes  
Landes modular  
**Strip\_**  
Cairo  
Dúo  
Ikaro  
Denim  
Lip  
Wave  
Sky  
Trent  
Escorpio  
Tauro  
Wood  
Mar  
Hole  
Aries  
Galsaky  
Small  
Homy  
Comet  
Tivoli  
Moon  
Dominó



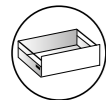

Interior cajones costilla metálicas  
*Metal interior drawers*  
 Interior gaveta com guia metálica  
*Interior caixa costella metálica*  
 Kaxoi barnekaldea saihets metalikoekin  
*Interior caixóns costela metálica*

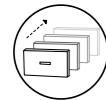

Cajón con cierre amortiguado  
*Drawer fitted with soft closing system*  
 Gaveta com sistema de correção com amortecedor  
*Caixas amb sistema de tancament suau*  
 Motelgailudun itxierazko kaxoia  
*Caixón con peche amortecido*



Guías Grass  
*Grass drawer sliding system*  
 Guia Grass  
 Guies Grass  
 Grass gidak  
 Guias Grass

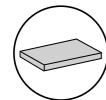

Acabado lacado mate  
*Matte lacquered finish*  
 Cor lacado mate  
 Acabat lacat mat  
 Mate lakatzko bukatua  
 Acabado lacado mate

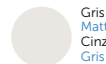

Gris suave mate  
 Matte light grey  
 Cinzento suave mate  
 Gris suau mat  
 Gris mate leuna  
 Gris suave mate



Gris intenso mate  
 Matte dark grey  
 Cinzento intenso mate  
 Gris intens mat  
 Gris mate bizia  
 Gris intenso mate



Pino lavado  
 Washed pine  
 Pinho lavado  
 Pi bianc  
 Pinu garbitua  
 Piñeiro lavado

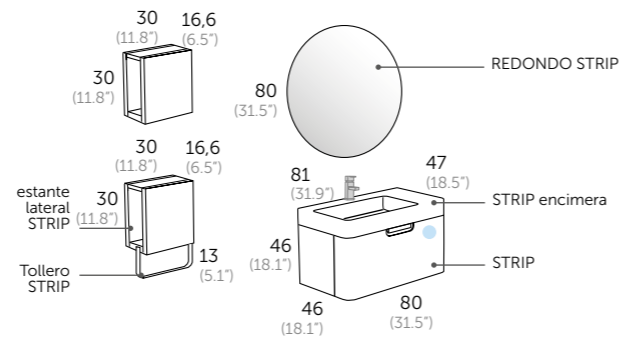

Composición **STRIP 80 (31.5")**

- 1 191 34 080 STRIP 80
- 1 593 01 080 STRIP encimera
- 1 291 00 081 REDONDO STRIP

Auxiliares

- 2 191 25 432 STRIP estante lateral
- 1 415 00 130 STRIP toallero





- Gris suave mate  
 Matte light grey  
 Cinzento suave mate  
 Gris suau mat  
 Gris mate leuna  
 Gris suave mate
- Gris intenso mate  
 Matte dark grey  
 Cinzento intenso mate  
 Gris intens mat  
 Gris mate bizia  
 Gris intenso mate
- Pino lavado  
 Washed pine  
 Pinho lavado  
 Pi blanc  
 Pinu garbitua  
 Piñeiro lavado

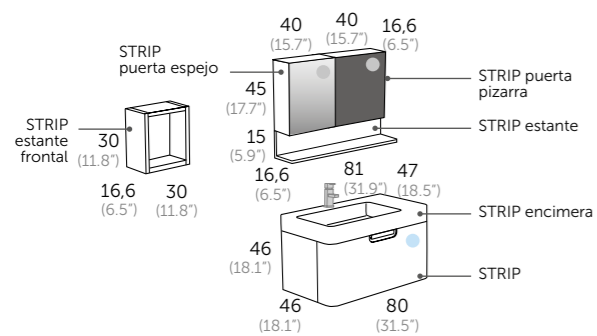

**Composición STRIP 80 (31.5")**

- 1 191 34 080 STRIP 80
- 1 593 01 080 STRIP encimera
- 1 191 25 441 STRIP puerta pizarra
- 1 191 25 440 STRIP puerta espejo
- 1 191 25 080 STRIP estante

**Auxiliares**

- 1 191 25 431 STRIP estante frontal



Interior cajones costilla metálicas  
*Metal interior drawers*  
 Interior gaveta com guia metálica  
*Interior calaix costella metàlica*  
 Kaxoi barnekaldea saihets metalikoekin  
*Interior caixóns costela metálica*

Cajón con cierre amortiguado  
*Drawer fitted with soft closing system*  
 Gaveta com sistema de corrediças com amortecedor  
*Calaixos amb sistema de tancament suau*  
 Motelgailudun itxierazko kajoia  
*Caixón con peche amortecido*

Guías Grass  
*Grass drawer sliding system*  
 Guia Grass  
*Guias Grass*  
 Grass gidak  
*Guias Grass*

Acabado lacado mate  
*Matte lacquered finish*  
 Cor lacado mate  
*Acabat lacat mat*  
 Mate lakatzuko bukatua  
*Acabado lacado mate*

Puerta con cierre amortiguado  
*Door with soft closing system*  
 Porta com amortecedor  
*Porta amb sistema de tancament suau*  
 Motelgailudun itxierazko atea  
*Porta con peche amortecido*



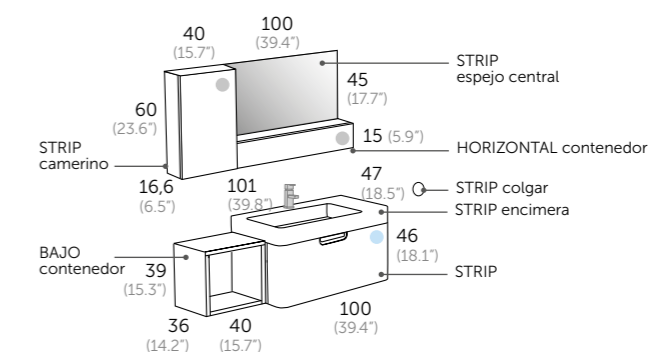

#### Composición **STRIP 100** (39.4")

- 1 191 34 100 STRIP 100
- 1 593 01 100 STRIP encimera
- 1 191 25 465 STRIP camerino
- 1 191 25 101 HORIZONTAL contenedor
- 1 291 00 103 STRIP espejo central
- 1 191 25 434 BAJO contenedor

#### Auxiliares

- 1 415 00 001 STRIP colgar

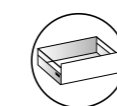

Interior cajones costilla metálicas  
*Metal interior drawers*  
 Interior gaveta com guia metálica  
*Interior calaix costella metàlica*  
 Kaxoi barnekaldea saihets metalikoekin  
*Interior caixòns costela metàlica*

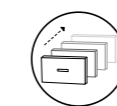

Cajón con cierre amortiguado  
*Drawer fitted with soft closing system*  
 Gaveta com sistema de corredeiras com amortecedor  
*Calaixos amb sistema de tancament suau*  
 Motelgailudun itxierazko kajoia  
*Caixón con peche amortecido*



Guías Grass  
*Grass drawer sliding system*  
 Guia Grass  
*Guias Grass*  
 Grass gidak  
*Guias Grass*

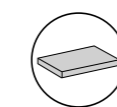

Acabado lacado mate  
*Matte lacquered finish*  
 Cor lacado mate  
*Acabat lacat mat*  
 Mate lakatzuko bukatua  
*Acabado lacado mate*



Puerta con cierre amortiguado  
*Door with soft closing system*  
 Porta com amortecedor  
*Porta amb sistema de tancament suau*  
 Motelgailudun itxierazko atea  
*Porta con peche amortecido*

- Gris suave mate  
 Matte light grey  
 Cinzento suave mate  
 Gris suau mat  
 Gris mate leuna  
 Gris suave mate
- Gris intenso mate  
 Matte dark grey  
 Cinzento intenso mate  
 Gris intens mat  
 Gris mate bizia  
 Gris intenso mate
- Pino lavado  
 Washed pine  
 Pinho lavado  
 Pi blanc  
 Pinu garbitua  
 Pineiro lavado

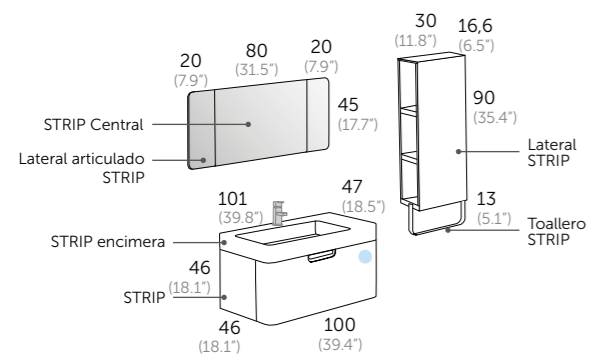

Composición **STRIP 100** (39.4")

- 1 191 33 100 STRIP 100
- 1 593 01 100 STRIP encimera
- 1 291 00 083 STRIP espejo central
- 2 291 00 023 STRIP espejo articulado

Auxiliares

- 1 191 25 433 STRIP estante 3 huecos
- 1 415 00 130 STRIP toallero

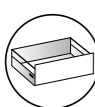

Interior cajones costilla metálicas  
*Metal interior drawers*  
 Interior gaveta com guia metálica  
*Interior calaix costella metálica*  
 Kaxoi barnekaldea saihets metalikoeekin  
*Interior caixons costela metálica*

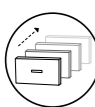

Cajón con cierre amortiguado  
*Drawer fitted with soft closing system*  
 Gaveta com sistema de correções com amortecedor  
*Calaixos amb sistema de tancament suau*  
 Motelgailudun itxierazko kajoia  
*Caixón con peche amortecido*



**GRASS**  
 Guías Grass  
*Grass drawer sliding system*  
 Guia Grass  
*Guias Grass*  
 Grass gidak  
*Guias Grass*

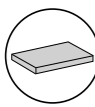

Acabado lacado mate  
*Matte lacquered finish*  
 Cor lacado mate  
*Acabat lacat mat*  
 Mate lakatzko bukatua  
*Acabado lacado mate*

Gris suave mate  
*Matte light grey*  
 Cinzento suave mate  
*Gris suau mat*  
 Gris mate leuna  
*Gris suave mate*

Gris intenso mate  
*Matte dark grey*  
 Cinzento intenso mate  
*Gris intens mat*  
 Gris mate bizia  
*Gris intenso mate*

Pino lavado  
*Washed pine*  
 Pinho lavado  
*Pi blanc*  
 Pinu garbitua  
*Piheiro lavado*



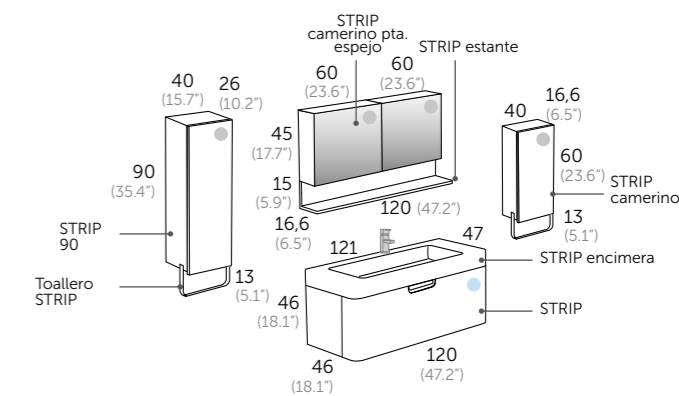

Composición **STRIP 120 (47.2")**

- 1 191 34 120 STRIP 120
- 1 593 01 120 STRIP encimera
- 1 191 25 120 STRIP estante
- 2 191 25 460 STRIP puerta espejo

Auxiliares

- 1 191 25 444 STRIP 90 contenedor
- 1 191 25 465 STRIP 60 contenedor
- 2 415 00 140 STRIP toallero

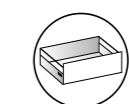

Interior cajones costilla metálicas  
*Metal interior drawers*  
 Interior gaveta com guia metálica  
*Interior calaix costella metàlica*  
 Kaxoi barnekaldea saihets metalikoeikin  
*Interior caixons costela metàlica*

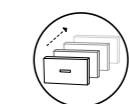

Cajón con cierre amortiguado  
*Drawer fitted with soft closing system*  
 Gaveta com sistema de correduças com amortecedor  
*Calaixos amb sistema de tancament suau*  
 Motelgailudun itxierazko kajoia  
*Caixon con peche amortecido*



Guías Grass  
*Grass drawer sliding system*  
 Guia Grass  
 Guies Grass  
 Grass gidak  
 Guias Grass

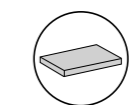

Acabado lacado mate  
*Matte lacquered finish*  
 Cor lacado mate  
 Acabat lacat mat  
 Mate lakatzuko bukatua  
 Acabado lacado mate



Puerta con cierre amortiguado  
*Door with soft closing system*  
 Porta com amortecedor  
 Porta amb sistema de tancament suau  
 Motelgailudun itxierazko atea  
 Porta con peche amortecido

● Gris suave mate  
 ● Matte light grey  
 ● Cinzento suave mate  
 ● Gris suau mat  
 ● Gris mate leuna  
 ● Gris suave mate

● Gris intenso mate  
 ● Matte dark grey  
 ● Cinzento intenso mate  
 ● Gris intens mat  
 ● Gris mate bizia  
 ● Gris intenso mate

● Pino lavado  
 ● Washed pine  
 ● Pinho lavado  
 ● Pi blanc  
 ● Pinu garbitua  
 ● Piñero lavado



## STRIP\_80 (31.5")

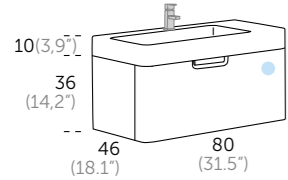

Acabado Referencia  
 Gris suave mate 191 33 080  
 Gris intenso mate 191 34 080

### ENCIMERA



**STRIP**  
 Referencia  
 593 01 080

### ESPEJOS / mirrors / espelhos / miralls / ispiluak / espellos

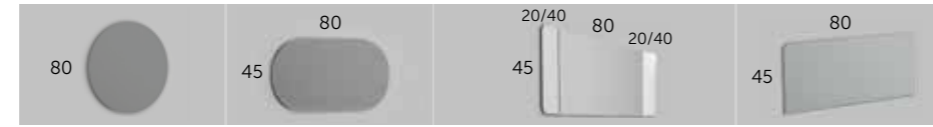

**REDONDO STRIP**  
 Referencia  
 291 00 081

**OBLONGO**  
 Referencia  
 291 00 082

**STRIP CENTRAL y LATERALES articulados**  
 Referencia  
 1 lateral 20x45 291 00 023  
 1 lateral 40x45 291 00 043  
 Central 80 291 00 083

**STRIP**  
 Referencia  
 291 00 080

## STRIP\_100 (39.4")

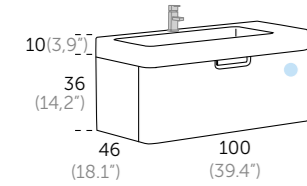

Acabado Referencia  
 Gris suave mate 191 33 100  
 Gris intenso mate 191 34 100

### ENCIMERA



**STRIP**  
 Referencia  
 593 01 100

### ESPEJOS / mirrors / espelhos / miralls / ispiluak / espellos



**REDONDO STRIP**  
 Referencia  
 291 00 101

**OBLONGO**  
 Referencia  
 291 00 102

**STRIP CENTRAL y LATERALES articulados**  
 Referencia  
 1 lateral 20x45 291 00 023  
 1 lateral 40x45 291 00 043  
 Central 80 291 00 083  
 Central 100 291 00 103

**STRIP**  
 Referencia  
 291 00 100

## STRIP\_120 (47.2")

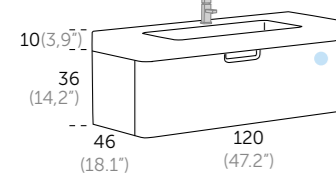

Acabado Referencia  
 Gris suave mate 191 33 120  
 Gris intenso mate 191 34 120

### ENCIMERA



**STRIP**  
 Referencia  
 593 01 120

### ESPEJOS / mirrors / espelhos / miralls / ispiluak / espellos

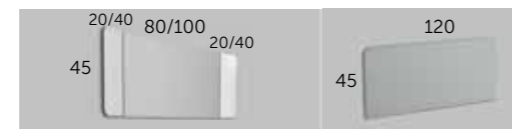

**STRIP CENTRAL y LATERALES articulados**  
 Referencia  
 1 lateral 20x45 291 00 023  
 1 lateral 40x45 291 00 043  
 Central 80 291 00 083  
 Central 100 291 00 103

**STRIP**  
 Referencia  
 291 00 120



Válvula universal  
 CLIC CLAC

Referencia  
 51601

## AUXILIARES / auxiliary units / auxiliares / auxiliars / osagarriak / auxiliares

### CAMERINOS

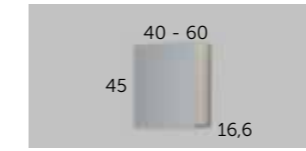

**STRIP puerta espejo**  
 Medidas Referencia  
 45x40x16,6 191 25 440  
 45x60x16,6 191 25 460

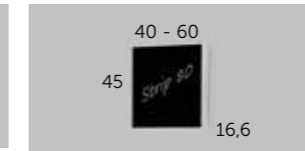

**STRIP puerta pizarra**  
 Medidas Referencia  
 45x40x16,6 191 25 441  
 45x60x16,6 191 25 461

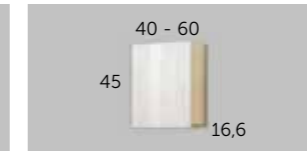

**STRIP**  
 Medidas Referencia  
 45x40x16,6 191 25 442  
 45x60x16,6 191 25 462



**STRIP**  
 Medidas Referencia  
 60x40x16,6 191 25 465

### ESTANTES

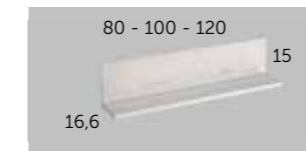

**STRIP**  
 Medidas Referencia  
 80x15x16,6 191 25 080  
 100x15x16,6 191 25 100  
 120x15x16,6 191 25 120



**FRONTAL**  
 Medidas Referencia  
 30x30x16,6 191 25 431



**LATERAL**  
 Medidas Referencia  
 30x30x16,6 191 25 432

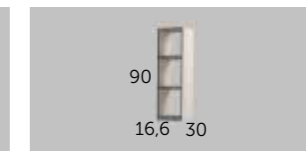

**LATERAL 3 huecos**  
 Medidas Referencia  
 30x90x16,6 191 25 433

### CONTENEDORES

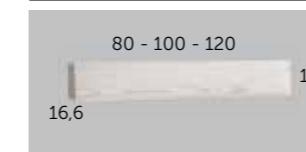

**HORIZONTAL**  
 Medidas Referencia  
 80x15x16,6 191 25 081  
 100x15x16,6 191 25 101  
 120x15x16,6 191 25 121



**BAJO**  
 Medidas Referencia  
 40x39x36 191 25 434

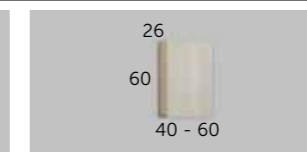

**STRIP 60**  
 Medidas Referencia  
 40x60x26 191 25 443  
 60x60x26 191 25 463

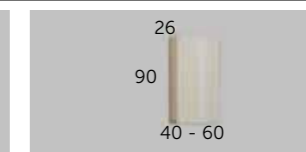

**STRIP 90**  
 Medidas Referencia  
 40x90x26 191 25 444  
 60x90x26 191 25 464

### ACCESORIOS

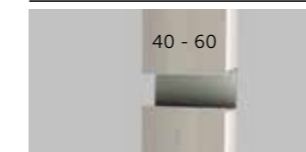

**ESPEJO**  
 Medidas Referencia  
 40x18x1,9 291 00 044  
 60x18x1,9 291 00 064



**TOALLERO**  
 Medidas Referencia  
 30 415 00 130  
 40 415 00 140  
 60 415 00 160

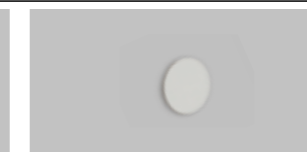

**COLGADOR**  
 Medidas Referencia  
 Blanco 415 01 001  
 Chrome 415 00 001  
 Negro 415 02 001



**Soporte encimera STRIP**  
 Referencia  
 410 00 190  
 Para instalarla directamente en la pared.

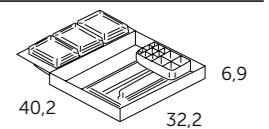

**Organizador opcional**  
 Referencia  
 411 00 001

## APLIQUES / spotlights / apliques / aplics / ezarkinak / apliques



**ESTHER LED**  
 Referencia  
 400 00 121 luz fría  
 400 00 221 luz cálida

**SOFIA LED**  
 Referencia  
 400 00 141 luz fría  
 400 00 241 luz cálida

**AINHOA LED**  
 Referencia  
 400 00 151 luz fría

**NIKITA LED**  
 Referencia  
 400 01 171 luz fría

**NAYRA LED**  
 Referencia  
 400 00 181 luz fría



Sigma  
Omega  
Landes  
Landes modular  
Strip  
**Cairo\_**

# Cairo

■ 80/100

Dúo  
Ikaro  
Denim  
Lip  
Wave  
Sky  
Trent

Escorpio  
Tauro  
Wood  
Mar  
Hole  
Aries  
Galsaky  
Small  
Homy  
Comet  
Tívoli  
Moon  
Dominó

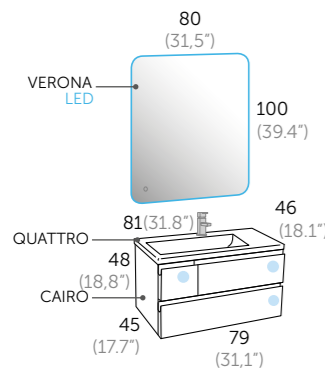

Composición **CAIRO 80** (31.5")

- 1 194 37 080 CAIRO 80
- 1 520 01 080 QUATTRO
- 1 246 00 100 VERONA LED

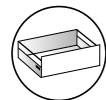

Interior cajones costilla metálicas  
*Metal interior drawers*  
 Interior gaveta com guia metálica  
*Interior caixa costella metálica*  
 Kaxoi barnekaldea saihets metalikoekin  
*Interior caixóns costela metálica*



Sistema antivaho  
*Anti fog system*  
 Sistema anti-vapor  
*Sistema antibaf*  
 Lurrunaren kontrako sistema  
*Sistema antivaho*

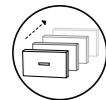

Cajón con cierre amortiguado  
*Drawer fitted with soft closing system*  
 Gaveta com sistema de corrediças com amortecedor  
*Calaixos amb sistema de tancament suau*  
 Motelgailudun itxierazko kajoia  
*Caixón con peche amortecido*



Sensor de contacto On/ Off  
*Contact sensor On/ Off*  
 Sensor interruptor On/ Off  
*Sensor de contacte On/ Off*  
 On/Off kontaktu sentsorea  
*Sensor de contacto On/ Off*



Guías Hettich  
*Hettich drawer sliding system*  
 Guias Hettich  
*Guias Hettich*  
 Hettich gidak  
*Guias Hettich*



Reversible  
*It is reversible*  
 Reversível  
*Reversível*  
 Itzulgarria  
*Reversibile*



Acabado melamina con textura  
*Textured melamine finish*  
 Cor melamina com textura  
*Acabat melamins amb textura*  
 Testuradun melamina bukatua  
*Acabado melanina con textura*



Luz ambiental  
*Ambient light*  
 Luz ambiente  
*Llum ambiental*  
 Giro-argia  
*Luz ambiental*

- |  |  |  |  |  |   |  |   |
|--|--|--|--|--|---|--|---|
|  | Blanco<br>White<br>Branco<br>Zuria<br>Branco |  | Roble natural<br>Natural oak<br>Carvalho natural<br>Roure natural<br>Haritz naturala<br>Carballo natural |  | Pino gris<br>Grey pine<br>Pinho cinzento<br>Pi gris<br>Pinu grisa<br>Piñeiro gris |  | Nogal oscuro<br>Dark walnut<br>Nogueira escuro<br>Nogueira fosc<br>Intxaurreondo iluna<br>Nogueira escura |
|--|--|--|--|--|---|--|---|



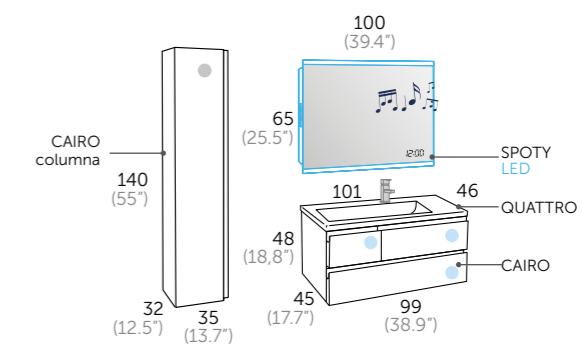

Composición **CAIRO 100** (39.4")

- 1 194 01 100 CAIRO 100
- 1 520 01 100 QUATTRO
- 1 267 00 100 SPOTY LED

Auxiliares

- 1 194 01 335 CAIRO columna

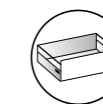

Interior cajones costilla metálicas  
*Metal interior drawers*  
 Interior gaveta com guia metálica  
*Interior calaix costella metàlica*  
 Kaxoi barnekaldea saiheits metalikoekin  
*Interior caixons costella metàlica*

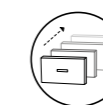

Cajón con cierre amortiguado  
*Drawer fitted with soft closing system*  
 Gaveta com sistema de correções com amortecedor  
*Calaixos amb sistema de tancament suau*  
 Motelgailudun itxierazko kajoia  
*Caixon con peche amortecido*



Guías Hettich  
*Hettich drawer sliding system*  
 Guias Hettich  
*Guias Hettich*  
 Hettich gidak  
*Guias Hettich*

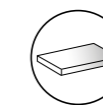

Acabado lacado brillo  
*High gloss lacquered finish*  
 Cor lacado brilhant  
*Acabat lacat brillant*  
 Distiradun lakatzuko bukatua  
*Acabado lacado brillo*



Puerta con cierre amortiguado  
*Door with soft closing system*  
 Porta com amortecedor  
*Porta amb sistema de tancament suau*  
 Motelgailudun itxierazko atea  
*Porta con peche amortecido*



Sistema antivaho  
*Anti fog system*  
 Sistema anti-vapor  
*Sistema antibaf*  
 Lurrunaren kontrako sistema  
*Sistema antivaho*



Sensor de contacto On/ Off  
*Contact sensor On/ Off*  
 Sensor interruptor On/ Off  
*Sensor de contacte On/ Off*  
 On/Off kontaktu sentsorea  
*Sensor de contacto On/ Off*



Reloj digital  
*Digital clock*  
 Relogio digital  
*Rellotge digital*  
 Erloju digitala  
*Reloxo dixital*



Luz ambiental  
*Ambient light*  
 Luz ambiente  
*Llum ambiental*  
 Giro-argia  
*Luz ambiental*



Reproductor musical integrado, con conexión bluetooth. 2 altavoces de 3 w cada uno.  
*Built in music player, bluetooth connection. 2 speakers of 3W each.*  
 Reprodutor musical integradu, con conexaso bluetooth 2 altifalantes de 3 w cada um.  
*Reprodutor musical integrat, amb connexió bluetooth. 2 altaveus de 3 w cadascú.*  
 Musika erreproduzitzaille integratua, bluetooth konexioarekin. 3w-dun bi bozgorailu.  
*Reprodutor musical integradu, con conexión bluetooth. 2 altofalantes de 3 w cada un.*

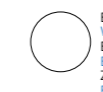

Blanco  
 White  
 Branco  
 Blanc  
 Zuria  
 Branco



Roble natural  
 Natural oak  
 Carvalho natural  
 Roure natural  
 Haritz naturala  
 Carballo natural



Pino gris  
 Grey pine  
 Pinho cinzento  
 Pi gris  
 Pinu grisa  
 Piñeiro gris

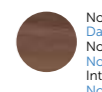

Nogal oscuro  
 Dark walnut  
 Nogueira escuro  
 Nogueira fosc  
 Intxaurrenko iluna  
 Nogueira escura

## CAIRO\_80 (31.5")

ESPEJOS Y CAMERINOS | más opciones en págs. 316 - 325

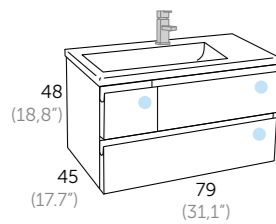

Acabado	Referencia
○ Blanco	194 01 080
● Roble natural	194 24 080
● Pino gris	194 37 080
● Nogal oscuro	194 39 080

### ENCIMERA / countertop / lavatorio / lavabo / gaineakoak / encimera



**QUATTRO** cerámica

Referencia  
520 01 080

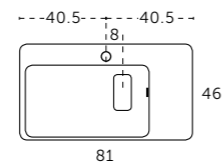

## CAIRO\_100 (39.4")

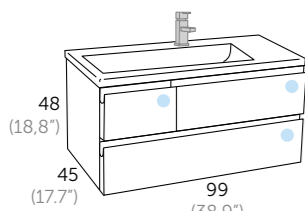

Acabado	Referencia
○ Blanco	194 01 100
● Roble natural	194 24 100
● Pino gris	194 37 100
● Nogal oscuro	194 39 100

### ENCIMERA / countertop / lavatorio / lavabo / gaineakoak / encimera



**QUATTRO** cerámica

Referencia  
520 01 100

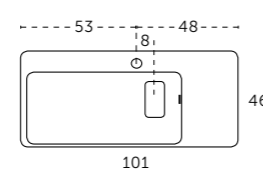

## AUXILIARES / auxiliary units / auxiliares / auxiliars / osagarriak / auxiliares

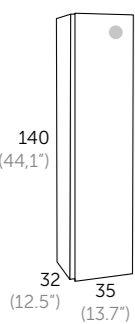

### CAIRO columna

Acabado	Referencia
○ Blanco	194 01 335
● Roble natural	194 24 335
● Pino gris	194 37 335
● Nogal oscuro	194 39 335



**Válvula universal CLIC CLAC**

Referencia  
51601

## ESPEJOS / mirrors / espelhos / miralls / ispiuak / espellos

CAMERINOS | armários / armário com espelho / camerinos / kamerinoak / camerinos /



**CLOUD**

Referencia  
205 00 080

**SIGMA**

Referencia  
290 00 080

**VERONA LED**

Referencia  
246 00 100

**HOLMES LED**

Referencia  
263 00 080

**TOWER LED**

Referencia  
262 00 080

**SPOTY LED**

Referencia  
267 00 080

**FLASH**

Referencia  
340 11 080

**SKYLINE**

Referencia  
● 341 11 080  
● 341 24 080

## ESPEJOS / mirrors / espelhos / miralls / ispiuak / espellos

CAMERINOS



**CLOUD**

Referencia  
205 00 100

**SIGMA**

Referencia  
290 00 100

**VERONA LED**

Referencia  
246 00 100

**CEBRA LED**

Referencia  
265 00 100

**HOLMES LED**

Referencia  
263 00 100

**SPOTY LED**

Referencia  
267 00 100

**SKYLINE**

Referencia  
● 341 11 100  
● 341 24 100

## APLIQUES / spotlights / apliques / aplics / ezarkinak / apliques



**ESTHER LED**

Referencia  
400 00 121  
luz fría  
400 00 221  
luz cálida

**SOFIA LED**

Referencia  
400 00 141  
luz fría  
400 00 241  
luz cálida

**AINHOA LED**

Referencia  
400 00 151  
luz fría

**NIKITA LED**

Referencia  
400 01 171  
luz fría

**NAYRA LED**

Referencia  
400 00 181  
luz fría

**Aplique SKYLINE LED**

cm Referencia  
60 400 00 511  
80 400 00 521  
100 400 00 531  
120 400 00 541

**Cornisa SKYLINE LED**

cm Referencia  
60 341 24 061  
80 341 24 081  
100 341 24 101  
120 341 24 121

Más colores en pág. 323



# Dúo

Sigma  
Omega  
Landes  
Landes modular  
Strip  
Cairo  
**Dúo\_**  
Ikaro  
Denim  
Lip  
Wave  
Sky  
Trent  
Escorpio  
Tauro  
Wood  
Mar  
Hole  
Aries  
Galsaky  
Small  
Homy  
Comet  
Tívoli  
Moon  
Dominó

\_70/105/140



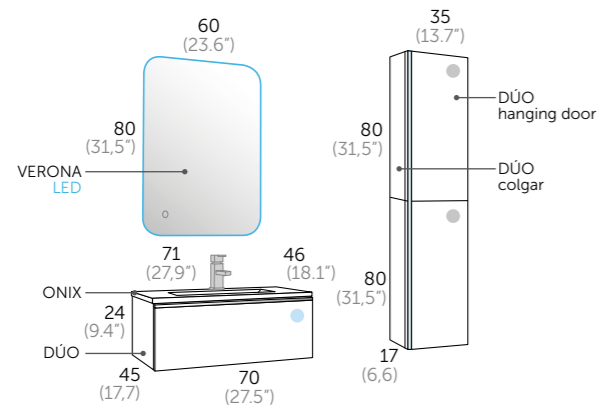

### Composición **DÚO 70** (27.5")

- 1 101 01 070 DÚO 70
- 1 500 01 070 ONIX
- 1 246 00 060 VERONA LED

### Auxiliares

- 2 101 01 435 DÚO colgar
- 2 101 01 535 DÚO puerta colgar

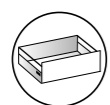

Interior cajones costilla metálicas  
*Metal interior drawers*  
 Interior gaveta com guia metálica  
*Interior calaix costella metálica*  
 Kaxoi barnekaldea saihets metalikoekin  
*Interior caixóns costela metálica*

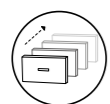

Cajón con cierre amortiguado  
*Drawer fitted with soft closing system*  
 Gaveta com sistema de corrediças com amortecedor  
*Calaixos amb sistema de tancament suau*  
 Motelgailudun itxierazko kajoia  
*Caixón con peche amortecido*



Puerta con cierre amortiguado  
*Door with soft closing system*  
 Porta com amortecedor  
*Porta amb sistema de tancament suau*  
 Motelgailudun itxierazko atea  
*Porta con peche amortecido*

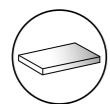

Acabado lacado brillo  
*High gloss lacquered finish*  
 Cor lacado brilho  
*Acabat lacat brillho*  
 Distiradun lakatzuko bukatua  
*Acabado lacado brillo*

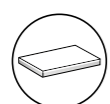

Frente con canto efecto cristal  
*Front with edge crystal effect*  
 Frente com canto efeito vidro  
*Frontal amb cantell efecte vidre*  
 Kristal efektudun ertzezko aurrekaldea  
*Fronte con canto efecto cristal*



Sistema antivaho  
*Anti fog system*  
 Sistema anti-vapor  
*Sistema anti-baf*  
 Lurrunaren kontrako sistema  
*Sistema antivaho*



Sensor de contacto On/ Off  
*Contact sensor On/ Off*  
 Sensor interruptor On/ Off  
*Sensor de contacte On/ Off*  
 On/Off kontaktu sentsorea  
*Sensor de contacto On/ Off*

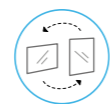

Reversible  
*It is reversible*  
 Reversible  
*Reversible*  
 Itzulgarria  
*Reversible*



Luz ambiental  
*Ambient light*  
 Luz ambiente  
*Llum ambiental*  
 Giro-argia  
*Luz ambiental*



Blanco  
 White  
 Branco  
 Blanc  
 Zuria  
 Branco



Gris  
 Grey  
 Cinzento  
 Gris  
 Grisa  
 Gris



Negro  
 Black  
 Preto  
 Blanc  
 Negre  
 Zuri-beltzean  
 Negro



Roble medio  
 Medium oak  
 Carvalho médio  
 Roure mitjà  
 Haritz ertainekoa  
 Carballo medio



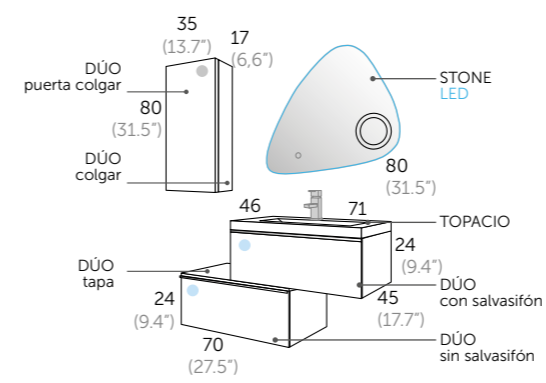









Composición **DÚO 70 (27.5")**

- 1 101 01 070 DÚO 70 (con salvafón)
- 1 101 01 071 DÚO 70 (sin salvafón)
- 1 101 01 207 DÚO tapa
- 1 505 01 070 TOPACIO
- 1 261 00 080 STONE LED

Auxiliares

- 1 101 01 435 DÚO colgar
- 1 101 01 535 DÚO puerta colgar



-  Interior cajones costilla metálicas  
Metal interior drawers  
Interior gaveta com guia metálica  
Interior calaix costella metálica  
Kaxoi barnekaldea saihets metalikoekin  
Interior caixóns costella metálica
-  Cajón con cierre amortiguado  
Drawer fitted with soft closing system  
Gaveta com sistema de correções com amortecedor  
Calaixos amb sistema de tancament suau  
Motelgailudun itxierazko kajoia  
Caixón con peche amortecido
-  Puerta con cierre amortiguado  
Door with soft closing system  
Porta com amortecedor  
Porta amb sistema de tancament suau  
Motelgailudun itxierazko atea  
Porta con peche amortecido
-  Acabado lacado brillo  
High gloss lacquered finish  
Cor lacado brilho  
Acabat lacat brillant  
Distiradun lakatzuko bukatua  
Acabado lacado brillo
-  Frente con canto efecto cristal  
Front with edge crystal effect  
Frente con canto efeito vidro  
Frontal amb cantell efecte vidre  
Kristol efektudun ertzezko aurrekaldea  
Fronte con canto efecto cristal
-  Sistema antivaho  
Anti fog system  
Sistema anti-vapor  
Sistema anti-bar  
Lurrunaren kontrako sistema  
Sistema antivaho
-  Sensor de contacto On/ Off  
Contact sensor On/ Off  
Sensor interruptor On/ Off  
Sensor de contacto On/ Off  
On/Off kontaktu sentsorea  
Sensor de contacto On/ Off
-  Lupa aumento x3  
Magnifying zoom in Mirror  
Lupa aumento 3x  
Lupa augment x3  
3x-eko haundiagotze lupa  
Lupa aumento x3
- 



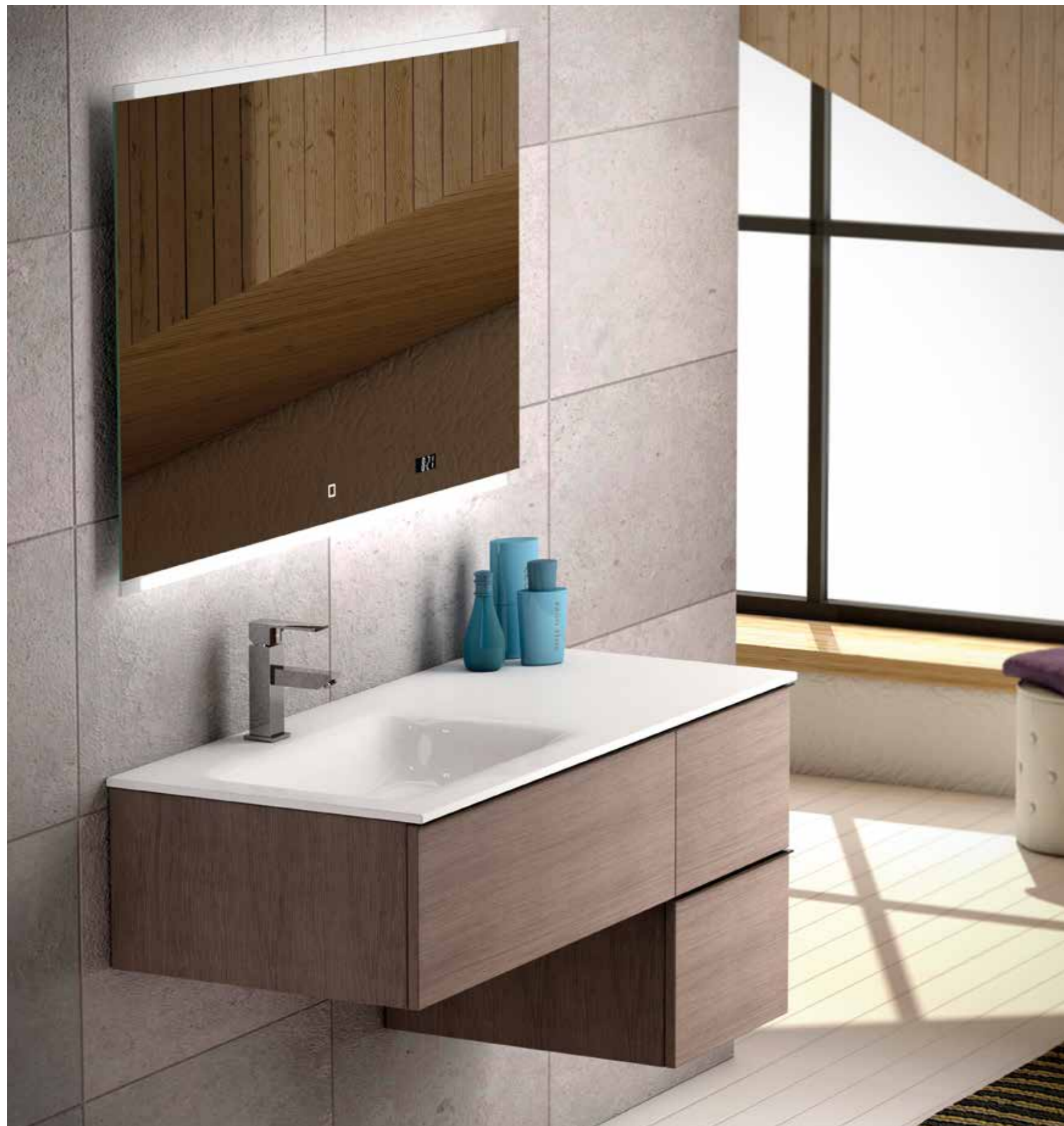

- Blanco  
White  
Branco
- Gris  
Grey  
Cinzento  
Grís  
Zuria  
Branco
- Negro  
Black  
Petro  
Negre  
Zuri-beltzean  
Negro
- Roble medio  
Medium oak  
Carvalho médio  
Roure mitj  
Haritz ertainekoa  
Carballo medio

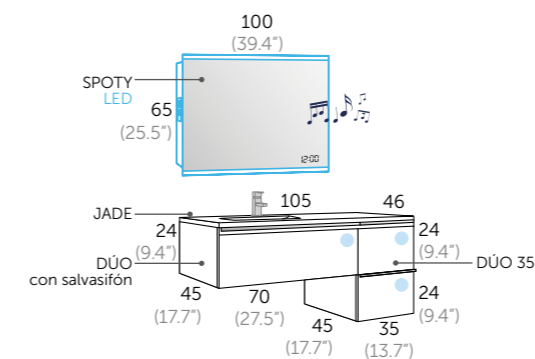

Composición **DÚO 105 (41")**

- 1 101 21 070 DÚO 70 (con salvafón)
- 2 101 21 035 DÚO 35
- 1 504 01 105 JADE
- 1 267 00 100 SPOTY LED

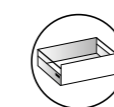

Interior cajones costilla metálicas  
*Metal interior drawers*  
Interior gaveta com guia metálica  
*Interior calaix costella metálica*  
Kaxoi barnekaldea saihets metalikoekin  
*Interior caixóns costela metálica*

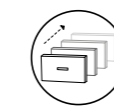

Cajón con cierre amortiguado  
*Drawer fitted with soft closing system*  
Gaveta com sistema de corrediças com amortecedor  
*Calaixos amb sistema de tancament suau*  
Motelgailudun itxierazko kajoia  
*Caixón con peche amortecido*

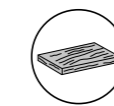

Acabado melamina con textura  
*Textured melamine finish*  
Cor melamina com textura  
*Acabat melamina amb textura*  
Testuradun melanina bukatua  
*Acabado melanina con textura*



Sistema antivaho  
*Anti fog system*  
Sistema anti-vapor  
*Sistema antibaf*  
Lurrunaren kontrako sistema  
*Sistema antivaho*



Sensor de contacto On/ Off  
*Contact sensor On/ Off*  
Sensor interruptor On/ Off  
*Sensor de contacte On/ Off*  
On/Off kontaktu sentsorea  
*Sensor de contacto On/ Off*



Reloj digital  
*Digital clock*  
Relógio digital  
*Relloge digital*  
Erluju digitala  
*Reloxo dixital*



Luz ambiental  
*Ambient light*  
Luz ambiente  
*Llum ambiental*  
Giro-argia  
*Luz ambiental*



Reproductor musical integrado, con conexión bluetooth. 2 altavoces de 3 w cada uno.  
*Built in music player, bluetooth connection. 2 speakers of 3W each.*  
Reproductor musical integrado, con conexión bluetooth 2 altavoces de 3 w cada um.  
*Reproductor musical integrat, amb connexió bluetooth. 2 altaveus de 3 w cadascú.*  
Musika erreproduzitzaile integratua, bluetooth konexioarekin. 3w-dun bi bozgorailu.  
*Reproductor musical integrado, con conexión bluetooth. 2 altofalantes de 3 w cada un.*

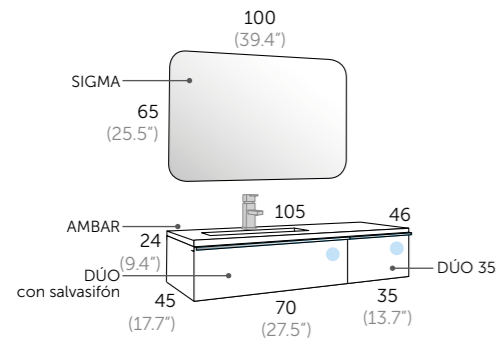

Composición **DÚO 105 (41.3")**

- 1 101 01 070 DÚO 70 (con salvafón)
- 1 101 01 035 DÚO 35
- 1 506 01 105 AMBAR
- 1 290 00 100 SIGMA

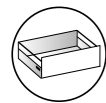

Interior cajones costilla metálicas  
*Metal interior drawers*  
 Interior gaveta com guia metálica  
*Interior calaix costella metàlica*  
 Kaxoi barnekaldea sailhets metalikoekin  
*Interior caixóns costela metálica*

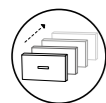

Cajón con cierre amortiguado  
*Drawer fitted with soft closing system*  
 Gaveta com sistema de corrediças com amortecedor  
*Calaixos amb sistema de tancament suau*  
 Motelgailudun itxierazko kajola  
*Caixón con peche amortecido*

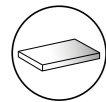

Acabado lacado brillo  
*High gloss lacquered finish*  
 Cor lacado brilho  
*Acabat lacat brillant*  
 Distiraadun lakatzuzko bukatua  
*Acabado lacado brillo*

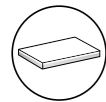

Frente con canto efecto cristal  
*Front with edge crystal effect*  
 Frente com canto efeito vidro  
*Frontal amb cantell efecte vidre*  
 Kristal efektudun ertzezko aurrekaldea  
*Fronte con canto efecto cristal*



Blanco  
 White  
 Branco  
 Blanc  
 Zuria  
 Branco



Gris  
 Grey  
 Cinzento  
 Gris  
 Grisa  
 Gris



Negro  
 Black  
 Petro  
 Negro  
 Zuri-beltzean  
 Negro

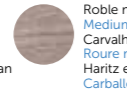

Roble medio  
 Medium oak  
 Carvalho médio  
 Roure mitjà  
 Haritz ertainekoa  
 Carballo medio



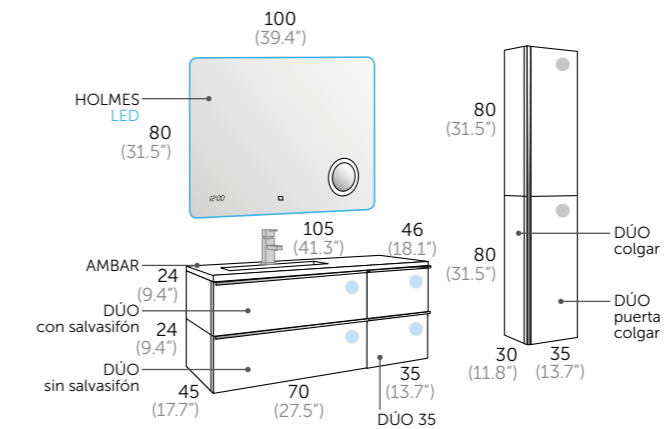

Composición **DÚO 105 (41.3")**

- 1 101 03 070 DÚO 70 (con salvafón)
- 1 101 03 071 DÚO 70 (sin salvafón)
- 2 101 03 035 DÚO 35
- 1 506 01 105 AMBAR
- 1 263 00 100 HOLMES LED

Auxiliares

- 2 101 03 436 DÚO colgar
- 2 101 03 535 DÚO puerta colgar

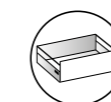

Interior cajones costilla metálicas  
*Metal interior drawers*  
 Interior gaveta com guia metálica  
*Interior calaix costella metálica*  
 Kaxoi barnekaldea saiñets metalikoekin  
*Interior caixons costela metálica*

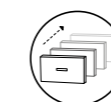

Cajón con cierre amortiguado  
*Drawer fitted with soft closing system*  
 Gaveta com sistema de corrediças com amortecedor  
*Caixaos amb sistema de tancament suau*  
 Motelgailudun itxierazko kajoia  
*Caixon con peche amortecido*



Puerta con cierre amortiguado  
*Door with soft closing system*  
 Porta com amortecedor  
 Porta amb sistema de tancament suau  
 Motelgailudun itxierazko atea  
*Porta con peche amortecido*

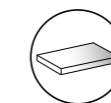

Acabado lacado brillo  
*High gloss lacquered finish*  
 Cor lacado brilho  
 Acabat lacat brillant  
 Distiradun lakatzko bukatua  
*Acabado lacado brillo*

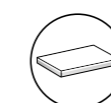

Frente con canto efecto cristal  
*Front with edge crystal effect*  
 Frente com canto efeito vidro  
 Frontal amb cantell efecte vidre  
 Kristal efektudun ertzezko aurrekaldea  
*Fronte con canto efecto cristal*



Sistema antivaho  
*Anti fog system*  
 Sistema anti-vapor  
 Sistema antibai  
 Lurrunaren kontrako sistema  
*Sistema antivaho*



Sensor de contacto On/ Off  
*Contact sensor On/ Off*  
 Sensor interruptor On/ Off  
 Sensor de contacte On/ Off  
 On/Off kontaktu sentsorea  
*Sensor de contacto On/ Off*



Reloj digital  
*Digital clock*  
 Relogio digital  
 Rellotje digital  
 Reloxo dixital



Lupa aumento x3  
*Magnifying zoom in Mirror*  
 Lupa aumento 3x  
 Lupa augment x3  
 3x-eko haundiagotze lupa  
*Lupa aumento x3*

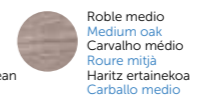

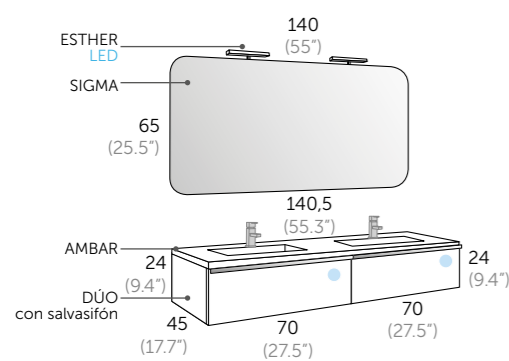

Composición **DÚO 140 (55")**

- 2 101 02 070 DÚO 70 (con salvafón)
- 1 506 01 142 AMBAR
- 1 290 00 140 SIGMA
- 2 400 00 121 ESTHER LED



- Blanco  
White  
Blanco  
Zuria  
Branco
- Gris  
Grey  
Cinzentu  
Gris  
Grisa  
Gris
- Negro  
Black  
Petro  
Negre  
Zuri-beltzean  
Negro
- Roble medio  
Medium oak  
Carvalho médio  
Roure mitjà  
Haritz ertainekoa  
Carballo medio

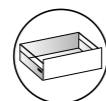

Interior cajones costilla metálica  
*Metal interior drawers*  
Interior gaveta com guia metálica  
*Interior calaix costella metálica*  
Kaxoi barnekaldea saihets metalikoekin  
*Interior caixòns costela metálica*

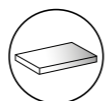

Acabado lacado brillo  
*High gloss lacquered finish*  
Cor lacado brilho  
*Acabat lacat brillant*  
Distiradun lakatzuzko bukatua  
*Acabado lacado brillo*

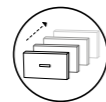

Cajón con cierre amortiguado  
*Drawer fitted with soft closing system*  
Gaveta com sistema de corrediças com amortecedor  
*Calaixos amb sistema de tancament suau*  
Motelgailudun itxierazko kajoia  
*Caixón con peche amortecido*

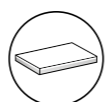

Frente con canto efecto cristal  
*Front with edge crystal effect*  
Frente com canto efeito vidro  
*Frontal amb cantell efecte vidre*  
Kristal efektudun irtzerazko aurrekaldea  
*Fronte con canto efecto cristal*

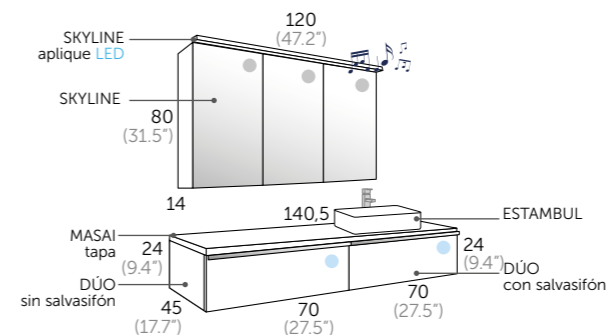

Composición **DÚO 140 (55")**

- 1 101 21 070 DÚO 70 (con salvafón)
- 1 101 21 071 DÚO 70 (sin salvafón)
- 1 519 02 140 MASAI tapa
- 1 507 01 005 ESTAMBUL
- 1 341 11 120 SKYLINE
- 1 400 00 541 Aplique SKYLINE LED



- Blanco  
White  
Blanco  
Zuria  
Branco
- Gris  
Grey  
Cinzentu  
Gris  
Grisa  
Gris
- Negro  
Black  
Petro  
Negre  
Zuri-beltzean  
Negro
- Roble medio  
Medium oak  
Carvalho médio  
Roure mitjà  
Haritz ertainekoa  
Carballo medio

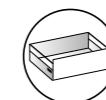

Interior cajones costilla metálica  
*Metal interior drawers*  
Interior gaveta com guia metálica  
*Interior calaix costella metálica*  
Kaxoi barnekaldea saihets metalikoekin  
*Interior caixòns costela metálica*

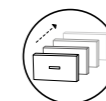

Cajón con cierre amortiguado  
*Drawer fitted with soft closing system*  
Gaveta com sistema de corrediças com amortecedor  
*Calaixos amb sistema de tancament suau*  
Motelgailudun itxierazko kajoia  
*Caixón con peche amortecido*

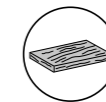

Acabado melamina con textura  
*Textured melamine finish*  
Cor melamina con textura  
*Acabat melamina amb textura*  
Testuradun melamina bukatua  
*Acabado melamina con textura*

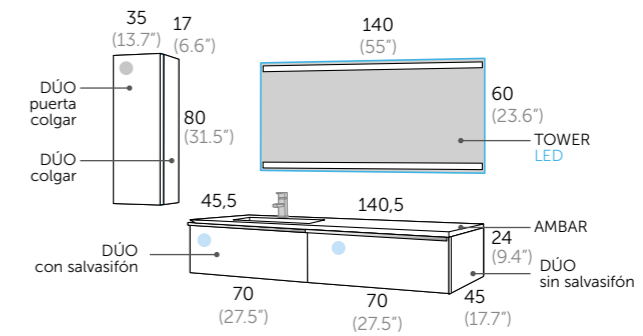
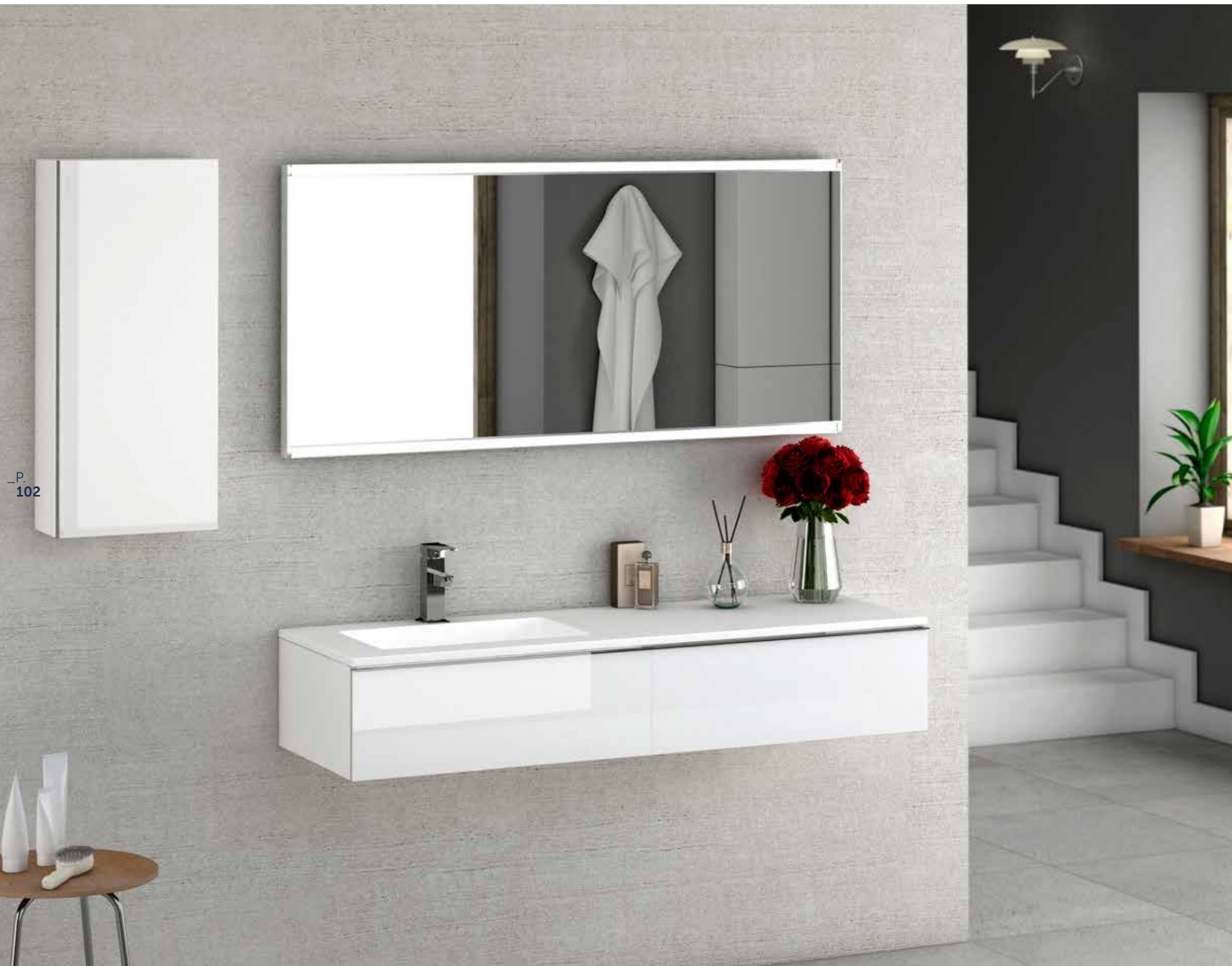

Composición **DÚO 140 (55")**

- 1 101 01 070 DÚO 70 (con salvafón)
- 1 101 01 071 DÚO 70 (sin salvafón)
- 1 506 01 143 AMBAR
- 1 262 00 140 TOWER LED

Auxiliares

- 1 101 01 435 DÚO colgar
- 1 101 01 535 DÚO puerta colgar



- 

**Interior cajones costilla metálicas**  
*Metal interior drawers*  
*Interior gaveta com guia metálica*  
*Interior caiaix costella metàlica*  
*Kaxoi barnekaldea saihets metalikoekin*  
*Interior caixóns costela metálica*
- 

**Cajón con cierre amortiguado**  
*Drawer fitted with soft closing system*  
*Gaveta com sistema de corrediças com amortecedor*  
*Caiaixos amb sistema de tancament suau*  
*Motelgailudun itxierazko kajoia*  
*Caixón con peche amortecido*
- 

**Puerta con cierre amortiguado**  
*Door with soft closing system*  
*Porta com amortecedor*  
*Porta amb sistema de tancament suau*  
*Motelgailudun itxierazko atea*  
*Porta con peche amortecido*
- 

**Acabado lacado brillo**  
*High gloss lacquered finish*  
*Cor lacado brilho*  
*Acabat lacat brillant*  
*Distiradun lakatuzko bukatua*  
*Acabado lacado brillo*
- 

**Frente con canto efecto cristal**  
*Front with edge crystal effect*  
*Frente com canto efeito vidro*  
*Frontal amb cantell efecte vidre*  
*Kristal efektudun ertzezko aurrekaldea*  
*Fronte con canto efecto cristal*
- 

**Sistema antivaho**  
*Anti fog system*  
*Sistema anti-vapor*  
*Sistema antibar*  
*Lurrunaren kontrako sistema*  
*Sistema antivaho*
- 

**Sensor infrarrojo On/Off**  
*Infrared sensor On/Off*  
*Sensor infravermelho On/ Off*  
*Sensor infraroig On/ Off*  
*On/Off sensore infragorria*  
*Sensor infravermelho On/Off*
- 

**Reversible**  
*It is reversible*  
*Reversível*  
*Itzulgarria*  
*Reversibile*

- 

Blanco  
White  
Branco  
Blanc  
Zuria  
Branco
- 

Gris  
Grey  
Cinzento  
Gris  
Grisa  
Gris
- 

Negro  
Black  
Petro  
Negre  
Zuri-beltzean  
Negro
- 

Roble medio  
Medium oak  
Carvalho médio  
Roure mitjà  
Haritz ertainekoa  
Carballo medio

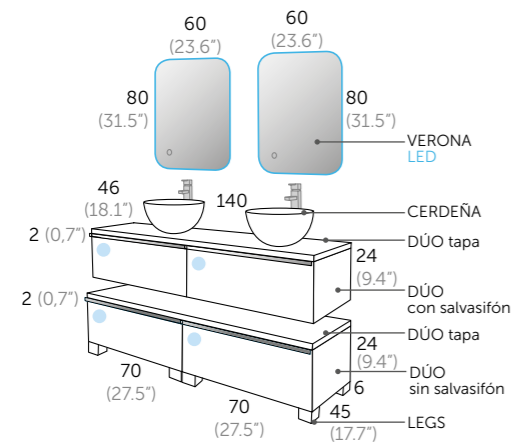

Composición **DÚO 140 (55")**

- 2 101 03 070 DÚO 70 (con salvafón)
- 2 101 03 071 DÚO 70 (sin salvafón)
- 2 101 03 214 DÚO tapa
- 2 507 01 040 CERDEÑA
- 2 246 00 060 VERONA LED
- 2 412 00 050 Patas (juego de 4)

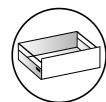

Interior cajones costilla metálicas  
*Metal interior drawers*  
 Interior gaveta com guia metálica  
*Interior caixas costella metálica*  
 Kaxoi barnekaldea saihets metalikoekin  
*Interior caixóns costela metálica*



Cajón con cierre amortiguado  
*Drawer fitted with soft closing system*  
 Gaveta com sistema de corrediças com amortecedor  
*Caixaos amb sistema de tancament suau*  
 Motelgailudun itxierazko kajoia  
*Caixon con peche amortecido*

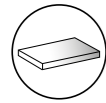

Acabado lacado brillo  
*High gloss lacquered finish*  
 Cor lacado brilho  
*Acabat lacat brillant*  
 Distirañun lakatuzko bukatua  
*Acabado lacado brillo*

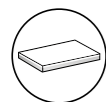

Frente con canto efecto cristal  
*Front with edge crystal effect*  
 Frente com canto efeito vidro  
*Frontal amb cantell efecte vidre*  
 Kristal efektudun ertzezko aurrekaldea  
*Fronte con canto efecto cristal*



Sistema antivaho  
*Anti fog system*  
 Sistema anti-vapor  
*Sistema anti-baf*  
 Lurrunaren kontrako sistema  
*Sistema antivaho*



Sensor de contacto On/ Off  
*Contact sensor On/ Off*  
 Sensor interruptor On/ Off  
*Sensor de contacte On/ Off*  
 On/Off kontaktu sentsorea  
*Sensor de contacto On/ Off*

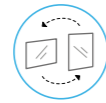

Reversible  
*It is reversible*  
 Reversível  
*Reversible*  
 Itzulgarria  
*Reversible*



Luz ambiental  
*Ambient light*  
 Luz ambiental  
*Llum ambiental*  
 Giro-argia  
*Luz ambiental*

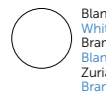

Blanco  
 White  
 Branco  
 Blanc  
 Zuria  
 Branco



Gris  
 Grey  
 Cinzento  
 Gris  
 Grisa  
 Gris



Negro  
 Black  
 Preto  
 Negre  
 Zuri-beltzean  
 Negro

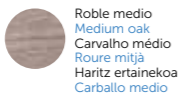

Roble medio  
 Medium oak  
 Carvalho médio  
 Roure mitjà  
 Haritz ertainekoa  
 Carballo medio





Interior cajones costilla metálicas  
 Metal interior drawers  
 Interior gaveta com guia metálica  
 Interior calaix costella metàlica  
 Kaxoi barnekaldea sailhets metalikoein  
 Interior caixóns costela metàlica

Cajón con cierre amortiguado  
 Drawer fitted with soft closing system  
 Gaveta com sistema de correções com amortecedor  
 Calaixos amb sistema de tancament suau  
 Motelgailudun itxierazko kajoia  
 Caixón con peche amortecido

Puerta con cierre amortiguado  
 Door with soft closing system  
 Porta com amortecedor  
 Porta amb sistema de tancament suau  
 Motelgailudun itxierazko atea  
 Porta con peche amortecido

Acabado lacado brillo  
 High gloss lacquered finish  
 Cor lacado brilho  
 Acabat lacat brillant  
 Distiradun lakatuzko bukatua  
 Acabado lacado brillo

Frente con canto efecto cristal  
 Front with edge crystal effect  
 Frente com canto efeito vidro  
 Frontal amb cantell efecte vidre  
 Kristal efektudun ertzezko aurrekaldea  
 Fronte con canto efecto cristal

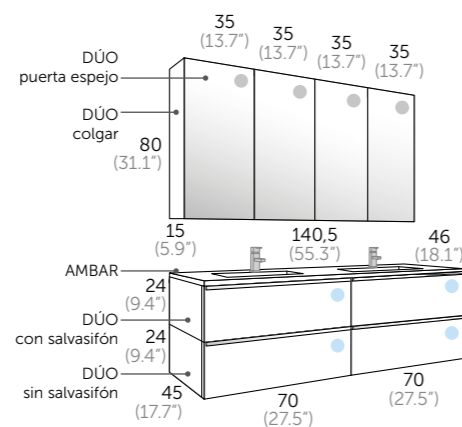

Composición **DÚO 140 (55")**

- 2 101 03 070 DÚO 70 (con salvafifón)
- 2 101 03 071 DÚO 70 (sin salvafifón)
- 1 506 01 142 AMBAR
- 4 101 03 435 DÚO colgar
- 4 101 00 535 DÚO puerta espejo



- Blanco  
White  
Branco  
Blanc  
Zuria  
Branco
- Gris  
Grey  
Cinzento  
Gris  
Gris  
Gris
- Negro  
Black  
Petro  
Negre  
Zuri-beltzean  
Negro
- Roble medio  
Medium oak  
Carvalho médio  
Roure mitja  
Haritz ertainekoa  
Carballo medio



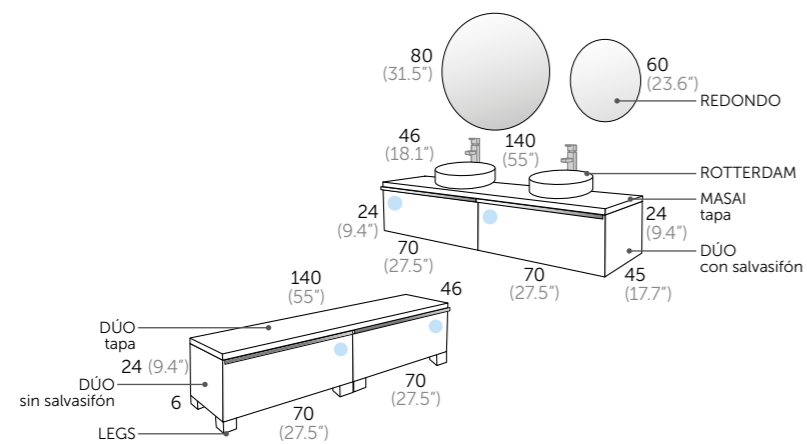

#### Composición **DÚO 140** (55")

- 2 101 01 070 DÚO 70 (con salvafón)
- 1 519 02 140 MASAI tapa
- 2 507 01 004 ROTTERDAM
- 1 244 00 060 REDONDO 70
- 1 244 00 080 REDONDO 80

#### Auxiliares

- 2 101 01 071 DÚO 70 (sin salvafón)
- 1 101 01 214 DÚO tapa
- 2 412 00 050 Patas (juego de 4)

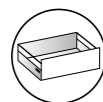

Interior cajones costilla metálicas  
*Metal interior drawers*  
 Interior gaveta com guia metálica  
*Interior caixa costella metálica*  
 Kaxoi barnekaldea saihets metalikoekin  
*Interior caixõns costela metálica*

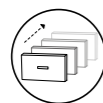

Cajón con cierre amortiguado  
*Drawer fitted with soft closing system*  
 Gaveta com sistema de corrediças com amortecedor  
*Calaixos amb sistema de tancament suau*  
 Motelgailudun itxierazko kajoia  
*Caixõn con peche amortecido*

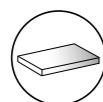

Acabado lacado brillo  
*High gloss lacquered finish*  
 Cor lacado brilho  
*Acabat lacat brillant*  
 Distiradun lakatzuko bukatua  
*Acabado lacado brillo*

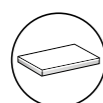

Frente con canto efecto cristal  
*Front with edge crystal effect*  
 Frente com canto efeito vidro  
*Frontal amb cantell efecte vidre*  
 Kristal efektudun ertezko aurrekaldea  
*Fronte con canto efecto cristal*



Blanco  
 White  
 Branco  
 Blanc  
 Blanc  
 Zuria  
 Branco



Grís  
 Grey  
 Cinzento  
 Gris  
 Grisa  
 Grís

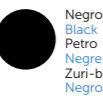

Negro  
 Black  
 Preto  
 Negre  
 Zuri-beltzean  
 Negro

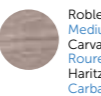

Roble medio  
 Medium oak  
 Carvalho médio  
 Roure mitjà  
 Haritz ertainekoa  
 Carballo medio





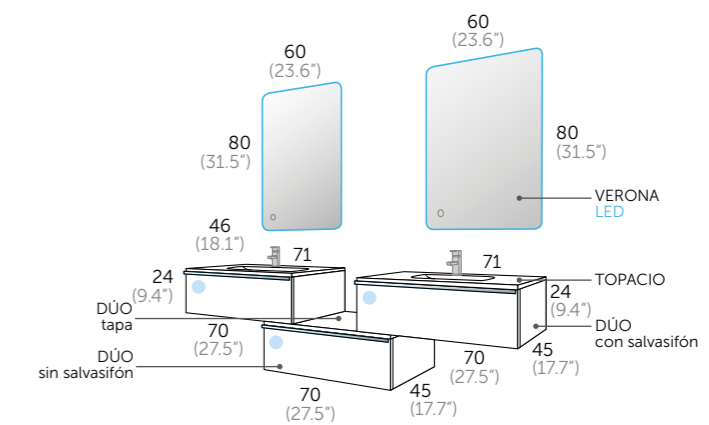



Composición **DÚO 175 (69")**

- 2 101 02 070 DÚO 70 (con salvafón)
- 1 101 02 071 DÚO 70 (sin salvafón)
- 1 101 02 207 DÚO tapa
- 2 505 01 070 TOPACIO
- 2 246 00 060 VERONA LED

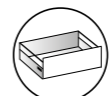

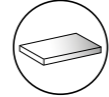

- 

**Interior cajones costilla metálicas**  
*Metal interior drawers*  
**Interior gaveta com guia metálica**  
*Interior calaix costella metálica*  
**Kaxoi barnekaldea saihets metalikoekin**  
*Interior caixóns costela metálica*
- 

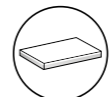
**Cajón con cierre amortiguado**  
*Drawer fitted with soft closing system*  
**Gaveta com sistema de corrediças com amortecedor**  
*Calaixos amb sistema de tancament suau*  
**Motelgailudun itxierazko kajoia**  
*Caixón con peche amortecido*
- 

**Acabado lacado brillo**  
*High gloss lacquered finish*  
**Cor lacado brilho**  
*Acabat lacat brillant*  
**Distiradun lakatzuko bukatua**  
*Acabado lacado brillo*
- 

**Frente con canto efecto cristal**  
*Front with edge crystal effect*  
**Frente com canto efeito vidro**  
*Frontal amb cantell efecte vidre*  
**Kristal efektudun ertzezko aurrekaldea**  
*Fronte con canto efecto cristal*
- 

**Sistema antivaho**  
*Anti fog system*  
**Sistema anti-vapor**  
*Sistema antibab*  
**Lurrunaren kontrako sistema**  
*Sistema antivaho*
- 

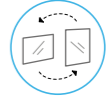
**Sensor de contacto On/ Off**  
*Contact sensor On/ Off*  
**Sensor interruptor On/ Off**  
*Sensor de contacte On/ Off*  
**On/Off kontaktu sensorea**  
*Sensor de contacto On/ Off*
- 

**Reversible**  
*It is reversible*  
**Reversible**  
*Reversibel*  
**Itzulgarria**  
*Reversible*
- 

**Luz ambiental**  
*Ambient light*  
**Luz ambiente**  
*Llum ambiental*  
**Giro-argia**  
*Luz ambiental*

- 

Blanco  
White  
Branco  
Blanc  
Zuria  
Branco
- 

Gris  
Grey  
Cinzento  
Gris  
Grisa  
Gris
- 

Negro  
Black  
Petro  
Negre  
Zuri-beltzean  
Negro
- 

Roble medio  
Medium oak  
Carvalho médio  
Roüre mitjà  
Haritz ertainekoa  
Carballo medio

## DÚO\_70 (27.5")

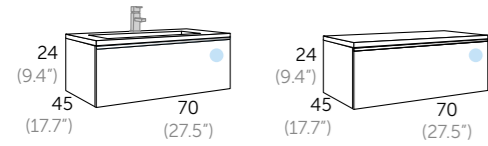

### DÚO 70 con salvafón

Acabado	Referencia
○ Blanco	101 01 070
● Gris	101 03 070
● Negro	101 02 070
● Roble medio	101 21 070

### DÚO 70 sin salvafón

Acabado	Referencia
○ Blanco	101 01 071
● Gris	101 03 071
● Negro	101 02 071
● Roble medio	101 21 071

## ENCIMERAS / countertops / lavatorios / lavabos / gainekoak / encimeras



<b>ONIX</b> cerámica Referencia 500 01 070	<b>TOPACIO</b> resina Referencia 505 01 070	<b>JADE</b> Referencia 504 01 070	<b>AMBAR</b> mate Referencia 506 01 070	<b>MASAI</b> Referencia 518 02 070 Más colores en pág. 308-311	<b>MASAI TAPA</b> Referencia 519 02 070 Más colores en pág. 313
---	--	--------------------------------------	--	--	---

ESPEJOS Y CAMERINOS más opciones en págs. 316 - 325

## ESPEJOS / mirrors / espelhos / miralls / ispiluak / espellos

CAMERINOS

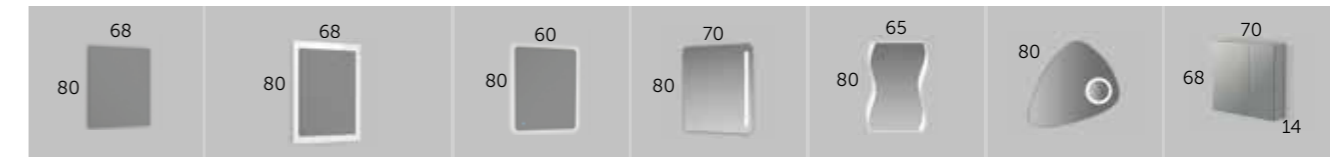

<b>CLOUD</b> Referencia 205 00 080	<b>TOOL</b> Acabado ○ Blanco Referencia 207 01 080 ● Gris 207 03 080 ● Roble medio 207 21 080	<b>VERONA LED</b> Referencia 246 00 060	<b>MILAN LED</b> Referencia 268 00 080	<b>MÓDENA LED</b> Referencia 264 00 080	<b>STONE LED</b> Referencia 261 00 080	<b>FLASH</b> Referencia 340 11 070
---------------------------------------	---	--	---	--	---	---------------------------------------

## DÚO\_105 (41.3")

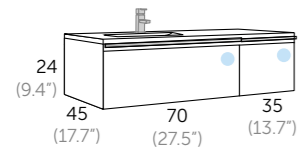

### DÚO 70 con salvafón

Acabado	Referencia
○ Blanco	101 01 070
● Gris	101 03 070
● Negro	101 02 070
● Roble medio	101 21 070

### DÚO 35

Acabado	Referencia
○ Blanco	101 01 035
● Gris	101 03 035
● Negro	101 02 035
● Roble medio	101 21 035

## ENCIMERAS / countertops / lavatorios / lavabos / gainekoak / encimeras

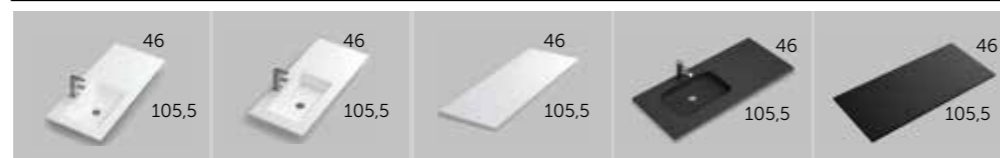

<b>JADE</b> masa blanca Referencia 504 01 105 Dcha. 504 01 106	<b>AMBAR</b> mate Referencia 506 01 105 Dcha. 506 01 106	<b>AMBAR TAPA</b> mate Referencia 508 01 105	<b>MASAI</b> Referencia 518 02 105 Más colores en pág. 308-311	<b>MASAI TAPA</b> Referencia 519 02 105 Más colores en pág. 313
--	--	---	--	---

## ESPEJOS / mirrors / espelhos / miralls / ispiluak / espellos

CAMERINOS

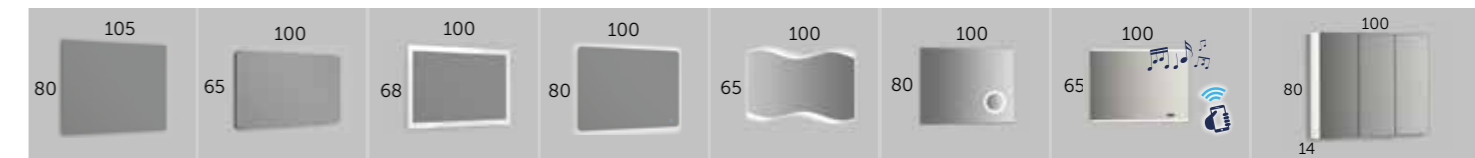

<b>MOON</b> Referencia 200 00 105	<b>SIGMA</b> Referencia 290 00 100	<b>TOOL</b> Referencia ○ 207 01 100 ● 207 03 100 ● 207 21 100	<b>VERONA LED</b> Referencia 246 00 100	<b>MÓDENA LED</b> Referencia 264 00 100	<b>HOLMES LED</b> Referencia 263 00 100	<b>SPOTY LED</b> Referencia 267 00 100	<b>SKYLINE</b> Referencia ○ 341 01 100 ● 341 03 100 ● 341 11 100
--------------------------------------	---------------------------------------	---	--	--	--	---	--

P. 112

## DÚO\_140 (55")

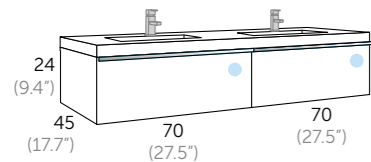

### DÚO 70 con salvafón

Acabado	Referencia
○ Blanco	101 01 070
● Gris	101 03 070
● Negro	101 02 070
● Roble medio	101 21 070

### DÚO 70 sin salvafón

Acabado	Referencia
○ Blanco	101 01 071
● Gris	101 03 071
● Negro	101 02 071
● Roble medio	101 21 071

## ENCIMERAS / countertops / lavatorios / lavabos / gainekoak / encimeras



<b>TOPACIO</b> Referencia 505 01 142	<b>AMBAR</b> mate Referencia 506 01 142	<b>AMBAR TAPA</b> mate Referencia 508 01 144	<b>MASAI</b> Referencia 518 02 140 Más colores en pág. 308-311	<b>MASAI TAPA</b> Referencia 519 02 140 Más colores en pág. 313
---	--	---	--	---

## ESPEJOS / mirrors / espelhos / miralls / ispiluak / espellos

CAMERINOS

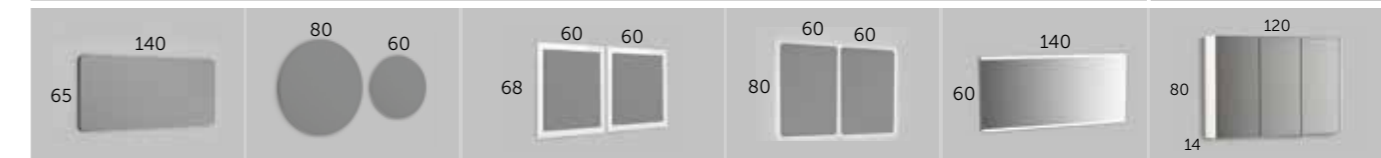

<b>SIGMA</b> Referencia 290 00 140	<b>REDONDO</b> Referencia 244 00 060 244 00 080	<b>TOOL</b> Acabado ○ Blanco Referencia 207 01 060 ● Gris 207 03 060 ● Roble medio 207 21 060	<b>VERONA LED</b> Referencia 246 00 060	<b>TOWER LED</b> Referencia 262 00 140	<b>SKYLINE</b> Referencia ○ 341 01 120 ● 341 03 120 ● 341 11 120
---------------------------------------	---	---	--	---	--

## DÚO TAPAS / tops / tampos / tapes / eztalkiak / tapas

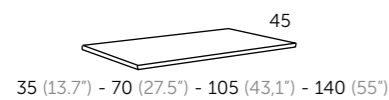

### Tapa 35

Acabado	Referencia
○ Blanco	101 01 203
● Gris	101 03 203
● Negro	101 02 203
● Roble medio	101 21 203

### Tapa 70

Referencia
101 01 207
101 03 207
101 02 207
101 21 207

### Tapa 105

Referencia
101 01 210
101 03 210
101 02 210
101 21 210

### Tapa 140

Referencia
101 01 214
101 03 214
101 02 214
101 21 214

## LAVABOS / washbasins / lavatorio pousar / lavabo sobreposar / gainjarritako konketa / lavabo sobrepoñer



<b>CERDEÑA</b> cerámica Referencia 507 01 040 Altura 15 cm	<b>ROTTERDAM</b> cerámica Referencia 507 01 004 Altura 10,5 cm	<b>OVAL</b> mate Referencia 509 01 001 Altura 12 cm
--	--	---

más opciones en págs. 314 - 315

## AUXILIARES / auxiliary units / auxiliares / auxiliars / osagarriak / auxiliares

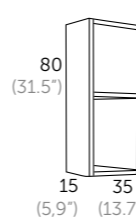

### DÚO COLGAR

<b>FONDO 15</b> Acabado ○ Blanco Referencia 101 01 435 ● Gris 101 03 435 ● Negro 101 02 435 ● Roble medio 101 21 435
---

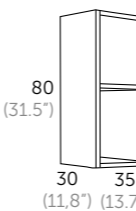

<b>FONDO 30</b> Acabado ○ Blanco Referencia 101 01 436 ● Gris 101 03 436 ● Negro 101 02 436 ● Roble medio 101 21 436
---

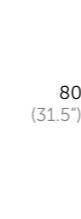

### DÚO PUERTA COLGAR

Acabado	Referencia
○ Blanco	101 01 535
● Gris	101 03 535
● Negro	101 02 535
● Roble medio	101 21 535
○ Espejo	101 00 535

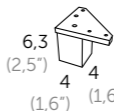

<b>PATAS (Juego de 4)</b> Referencia 412 00 050
--

## APLIQUES

más opciones en pág. 326



<b>ESTHER LED</b> Referencia 400 00 121 luz fría 400 00 221 luz cálida	<b>SOFIA LED</b> Referencia 400 00 141 luz fría 400 00 241 luz cálida
--	---

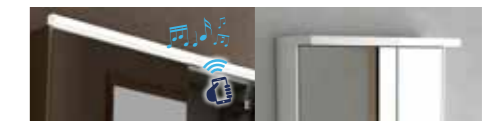

<b>Aplique SKYLINE LED</b> cm Referencia 60 400 00 511 80 400 00 521 100 400 00 531 120 400 00 541	<b>Cornisa SKYLINE LED</b> cm Referencia 60 341 01 061 80 341 01 081 100 341 01 101 120 341 01 121 Más colores en pág. 323
---	--

P. 113

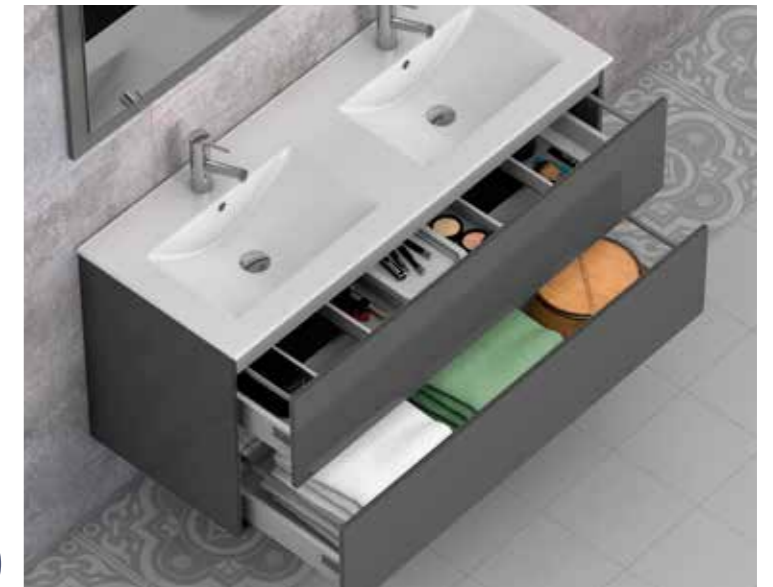

60/80/100/120

# Ikaro

Sigma  
Omega  
Landes  
Landes modular  
Strip  
Cairo  
Dúo  
**Ikaro\_**  
Denim  
Lip  
Wave  
Sky  
Trent  
Escorpio  
Tauro  
Wood  
Mar  
Hole  
Aries  
Galsaky  
Small  
Homy  
Comet  
Tívoli  
Moon  
Dominó

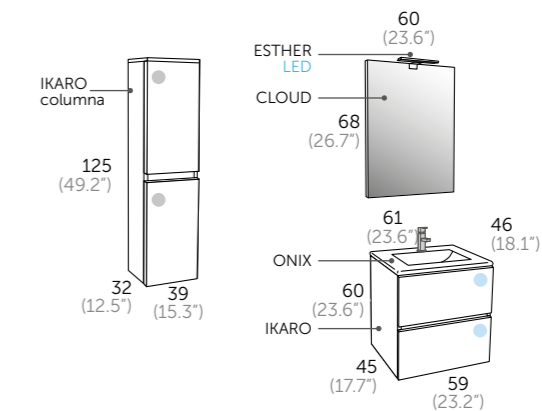

Composición **IKARO 60** (23.6")

- 1 107 01 060 IKARO 60
- 1 500 01 060 ONIX
- 1 205 00 060 CLOUD
- 1 400 00 121 ESTHER LED

Auxiliares

- 1 107 01 338 IKARO columna

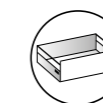

Interior cajones costilla metálicas  
*Metal interior drawers*  
 Interior gaveta com guia metálica  
*Interior calaix costella metálica*  
 Kaxoi barnekaldea sailhets metalikoekin  
*Interior caixóns costela metálica*



Cajón con cierre amortiguado  
*Drawer fitted with soft closing system*  
 Gaveta com sistema de corrediças com amortecedor  
*Calaixos amb sistema de tancament suau*  
 Motelgailudun itxierazko kajoia  
*Caixón con peche amortecido*



Puerta con cierre amortiguado  
*Door with soft closing system*  
 Porta com amortecedor  
*Porta amb sistema de tancament suau*  
 Motelgailudun itxierazko atea  
*Porta con peche amortecido*

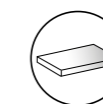

Acabado lacado brillo  
*High gloss lacquered finish*  
 Cor lacado brilho  
*Acabat lacat brillant*  
 Distiradun lakatuzko bukatua  
*Acabado lacado brillo*



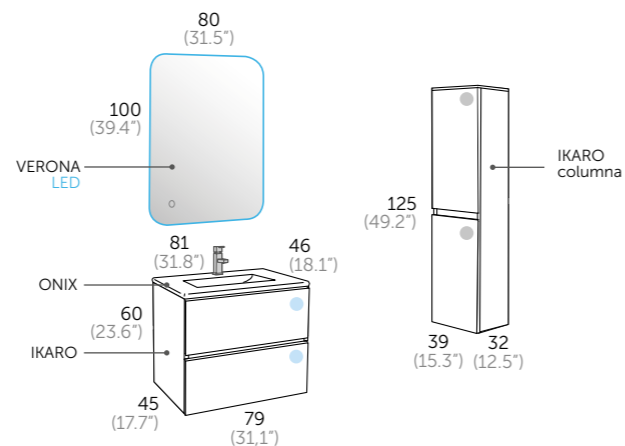

Composición **IKARO 80 (31.5)**

- 1 107 03 080 IKARO 80
- 1 500 01 080 ONIX
- 1 246 00 100 VERONA LED

Auxiliares

- 1 107 03 338 IKARO columna

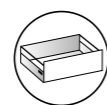

Interior cajones costilla metálicas  
*Metal interior drawers*  
 Interior gaveta com guia metálica  
*Interior calaix costella metálica*  
 Kaxoi barnekaldea saihets metalikoekin  
*Interior caixons costela metálica*

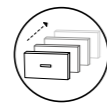

Cajón con cierre amortiguado  
*Drawer fitted with soft closing system*  
 Gaveta com sistema de correções com amortecedor  
*Caixaos amb sistema de tancament suau*  
 Motelgailudun itxierazko kajoia  
*Caixón con peche amortecido*



Puerta con cierre amortiguado  
*Door with soft closing system*  
 Porta com amortecedor  
 Porta amb sistema de tancament suau  
 Motelgailudun itxierazko atea  
*Porta con peche amortecido*

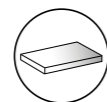

Acabado lacado brillo  
*High gloss lacquered finish*  
 Cor lacado brilho  
 Acabat lacat brillant  
 Distiradun lakatzko bukatua  
*Acabado lacado brillo*



Sistema antivaho  
*Anti fog system*  
 Sistema anti-vapor  
 Sistema antibaf  
 Lurrunaren kontrako sistema  
*Sistema antivaho*



Sensor de contacto On/ Off  
*Contact sensor On/ Off*  
 Sensor interruptor On/ Off  
 Sensor de contacte On/ Off  
 On/Off kontaktu sentsorea  
*Sensor de contacto On/ Off*

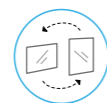

Reversible  
*It is reversible*  
 Reversível  
 Reversible  
 Itzulgarria  
*Reversible*



Luz ambiental  
*Ambient light*  
 Luz ambiente  
 Llum ambiental  
 Giro-argia  
*Luz ambiental*

Blanco  
 White  
 Branco  
 Blanc  
 Zuria  
 Branco

Gris  
 Grey  
 Cinzento  
 Gris  
 Grisa  
 Gris



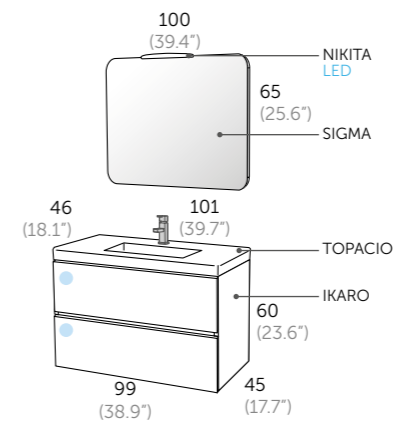

Composición **IKARO 100** (39.4")

- 1 107 01 100 IKARO 100
- 1 505 01 100 TOPACIO
- 1 290 00 100 SIGMA
- 1 400 01 171 NIKITA LED

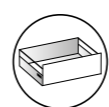

Interior cajones costilla metálicas  
*Metal interior drawers*  
 Interior gaveta com guia metálica  
*Interior calaix costella metálica*  
 Kaxoi barnekaldea saihets metalikoekin  
*Interior caixóns costela metálica*



Cajón con cierre amortiguado  
*Drawer fitted with soft closing system*  
 Gaveta com sistema de corredeiras com amortecedor  
*Calaixos amb sistema de tancament suau*  
 Motelgailudun itxierazko kajoia  
*Caixón con peche amortecido*

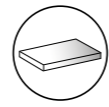

Acabado lacado brillo  
*High gloss lacquered finish*  
 Cor lacado brilho  
*Acabat lacat brillant*  
 Distiradun lakatzko bukatua  
*Acabado lacado brillo*



Blanco  
 White  
 Branco  
 Blanc  
 Zuria  
 Branco

Gris  
 Grey  
 Cinzento  
 Gris  
 Grisa  
 Gris

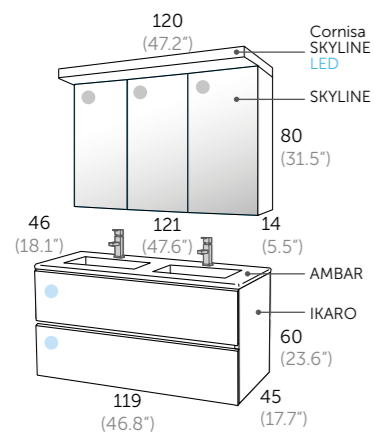

Composición **IKARO 120** (47.2")

- 1 107 03 120 IKARO 120
- 1 506 01 122 AMBAR
- 1 341 03 120 SKYLINE
- 1 341 03 121 Cornisa SKYLINE LED

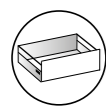

Interior cajones costilla metálicas  
*Metal interior drawers*  
 Interior gaveta com guia metálica  
*Interior caixa costella metálica*  
 Kaxoi barnekaldea saihets metalikoeekin  
*Interior caixóns costela metálica*

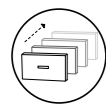

Cajón con cierre amortiguado  
*Drawer fitted with soft closing system*  
 Gaveta com sistema de correções com amortecedor  
*Calaixos amb sistema de tancament suau*  
 Motelgailudun itxierazko kajoia  
*Caixón con peche amortecido*

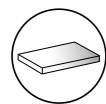

Acabado lacado brillo  
*High gloss lacquered finish*  
 Cor lacado brilho  
*Acabat lacat brillant*  
 Distiradun lakatuzko bukatua  
*Acabado lacado brillo*



Puerta con cierre amortiguado  
*Door with soft closing system*  
 Porta com amortecedor  
*Porta amb sistema de tancament suau*  
 Motelgailudun itxierazko atea  
*Porta con peche amortecido*





Compatible con modelo Galsaky

# Look\_

## Auxiliar

### Auxiliar LOOK

Blanco 107 01 024 LOOK  
Gris 107 03 024 LOOK

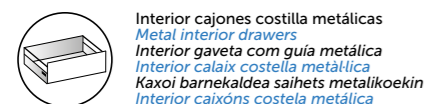
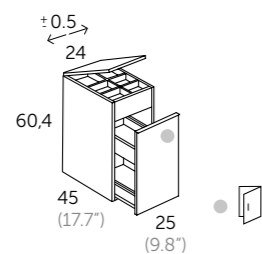

Interior cajones costilla metálicas  
*Metal interior drawers*  
Interior gaveta com guia metálica  
*Interior calaix costella metálica*  
Kaxoi barnekaldea saihets metalikoekin  
*Interior caixóns costela metálica*

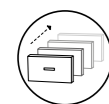

Cajón con cierre amortiguado  
*Drawer fitted with soft closing system*  
Gaveta com sistema de correções com amortecedor  
*Calaixos amb sistema de tancament suau*  
Motelgailudun itxierazko kajoia  
*Caixón con peche amortecido*



Puerta con cierre amortiguado  
*Door with soft closing system*  
Porta com amortecedor  
*Porta amb sistema de tancament suau*  
Motelgailudun itxierazko atea  
*Porta con peche amortecido*

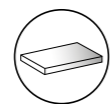

Acabado lacado brillo  
*High gloss lacquered finish*  
Cor lacado briho  
*Acabat lacat brillant*  
Distiradun lakatzeko bukatua  
*Acabado lacado briho*





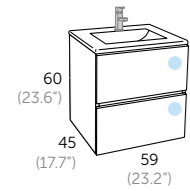

Acabado Referencia  
 ○ Blanco 107 01 060  
 ● Gris 107 03 060

ENCIMERAS / countertops / lavatorios / lavabos / gainekoak / encimeras



<b>ONIX</b> cerámica Referencia 500 01 060	<b>TOPACIO</b> resina Referencia 505 01 060	<b>JADE</b> masa blanca Referencia 504 01 060	<b>MASAI</b> Referencia 518 02 060 Más colores en pág. 308-311	<b>CRISTAL</b> Acabado Metalizado Negro Referencia 502 11 060 Referencia 502 02 060
---	--	--	--	--

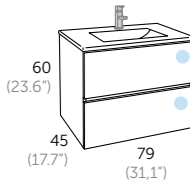

Acabado Referencia  
 ○ Blanco 107 01 080  
 ● Gris 107 03 080

ENCIMERAS / countertops / lavatorios / lavabos / gainekoak / encimeras



<b>ONIX</b> cerámica Referencia 500 01 080	<b>TOPACIO</b> resina Referencia 505 01 080	<b>JADE</b> masa blanca Referencia 504 01 080	<b>AMBAR</b> mate Referencia 506 01 080	<b>MASAI</b> Referencia 518 02 080 Más colores en pág. 308-311	<b>CRISTAL</b> Acabado Metalizado Negro Referencia 502 11 080 Referencia 502 02 080
---	--	--	--	--	--

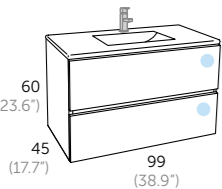

Acabado Referencia  
 ○ Blanco 107 01 100  
 ● Gris 107 03 100

ENCIMERAS / countertops / lavatorios / lavabos / gainekoak / encimeras

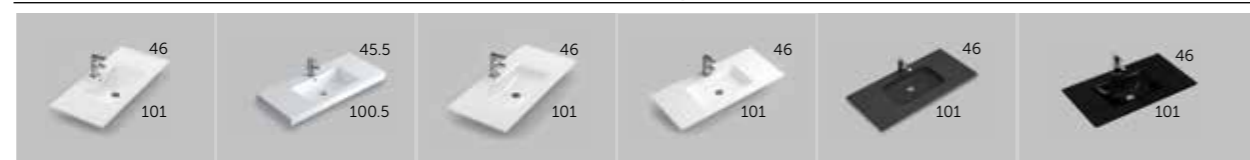

<b>ONIX</b> cerámica Referencia 500 01 100	<b>TOPACIO</b> resina Referencia 505 01 100	<b>JADE</b> masa blanca Referencia 504 01 100	<b>AMBAR</b> mate Referencia 506 01 100	<b>MASAI</b> Referencia 518 02 100 Más colores en pág. 308-311	<b>CRISTAL</b> Acabado Metalizado Negro Referencia 502 11 100 Referencia 502 02 100
---	--	--	--	--	--

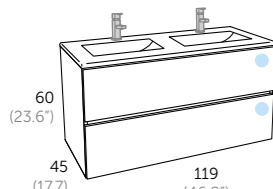

Acabado Referencia  
 ○ Blanco 107 01 120  
 ● Gris 107 03 120

ENCIMERAS / countertops / lavatorios / lavabos / gainekoak / encimeras



<b>ONIX</b> cerámica Referencia 500 01 120	<b>ONIX</b> cerámica Referencia 500 01 122	<b>TOPACIO</b> Referencia 505 01 120	<b>TOPACIO</b> Referencia 505 01 122	<b>AMBAR</b> Referencia 506 01 120	<b>AMBAR</b> Referencia 506 01 121	<b>AMBAR</b> Referencia 506 01 122	<b>MASAI</b> Referencia 518 02 122 Más colores en pág. 308-311
---	---	---	---	---------------------------------------	---------------------------------------	---------------------------------------	--

AUXILIARES / auxiliary units / auxiliares / auxiliars / osagarriak / auxiliares

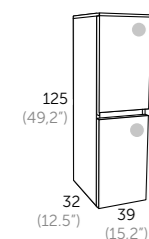

IKARO columna

Acabado Referencia  
 ○ Blanco 107 01 338  
 ● Gris 107 03 338

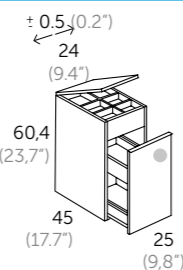

LOOK

Acabado Referencia  
 ○ Blanco 107 01 024  
 ● Gris 107 03 024



Vátvula universal CLIC CLAC

Referencia 51601

ESPEJOS / mirrors / espelhos / miralls / ispiluak / espellos

CAMERINOS / armoires / armário com espelho / camerinos / kamerinoak / camerinos /



<b>CLOUD</b> Referencia 205 00 060	<b>REDONDO</b> Referencia 244 00 060	<b>TOOL</b> Referencia ○ 207 01 060 ● 207 03 060	<b>RAIN LED</b> Referencia 269 00 060	<b>VERONA LED</b> Referencia 246 00 060	<b>MÓDENA LED</b> Referencia 264 00 080	<b>FLASH</b> Referencia 340 11 060	<b>SKYLINE</b> Referencia ○ 341 01 060 ● 341 03 060
---------------------------------------	---	--	--	--	--	---------------------------------------	---

ESPEJOS / mirrors / espelhos / miralls / ispiluak / espellos

CAMERINOS / armoires / armário com espelho / camerinos / kamerinoak / camerinos /

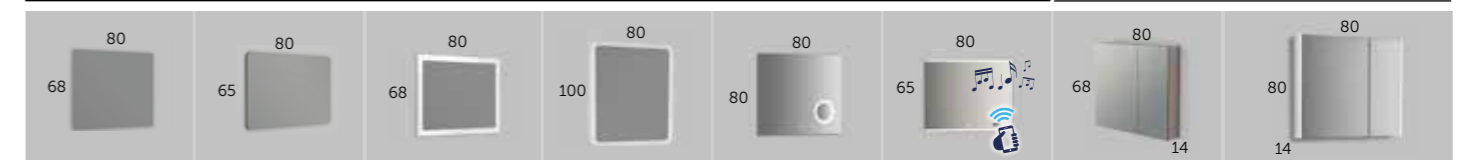

<b>CLOUD</b> Referencia 205 00 080	<b>SIGMA</b> Referencia 290 00 080	<b>TOOL</b> Referencia ○ 207 01 080 ● 207 03 080	<b>VERONA LED</b> Referencia 246 00 100	<b>HOLMES LED</b> Referencia 263 00 080	<b>SPOTY LED</b> Referencia 267 00 080	<b>FLASH</b> Referencia 340 11 080	<b>SKYLINE</b> Referencia ○ 341 01 080 ● 341 03 080
---------------------------------------	---------------------------------------	--	--	--	---	---------------------------------------	---

ESPEJOS / mirrors / espelhos / miralls / ispiluak / espellos

CAMERINOS

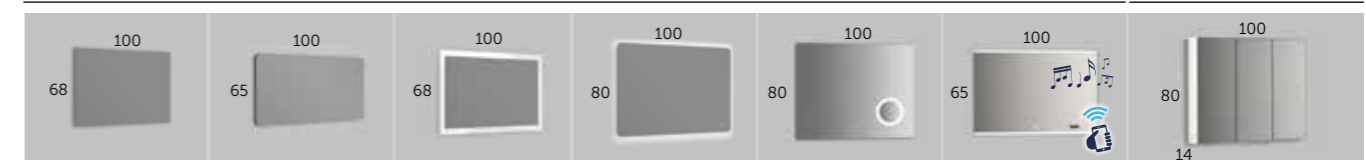

<b>CLOUD</b> Referencia 205 00 100	<b>SIGMA</b> Referencia 290 00 100	<b>TOOL</b> Referencia ○ 207 01 100 ● 207 03 100	<b>VERONA LED</b> Referencia 246 00 100	<b>HOLMES LED</b> Referencia 263 00 100	<b>SPOTY LED</b> Referencia 267 00 100	<b>SKYLINE</b> Referencia ○ 341 01 100 ● 341 03 100
---------------------------------------	---------------------------------------	--	--	--	---	---

ESPEJOS / mirrors / espelhos / miralls / ispiluak / espellos

CAMERINOS / armoires / armário com espelho / camerinos / kamerinoak / camerinos /

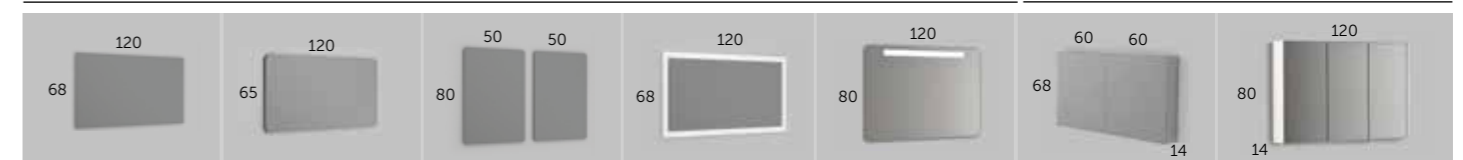

<b>CLOUD</b> Referencia 205 00 120	<b>SIGMA</b> Referencia 290 00 120	<b>NITRO</b> Referencia 241 00 050	<b>TOOL</b> Referencia ○ 207 01 120 ● 207 03 120	<b>RAIN LED</b> Referencia 269 00 120	<b>FLASH</b> Referencia 340 11 060	<b>SKYLINE</b> Referencia ○ 341 01 120 ● 341 03 120
---------------------------------------	---------------------------------------	---------------------------------------	--	--	---------------------------------------	---

APLIQUES / spotlights / apliques / aplics / ezarkinak / apliques



<b>ESTHER LED</b> Referencia 400 00 121 luz fría 400 00 221 luz cálida	<b>SOFIA LED</b> Referencia 400 00 141 luz fría 400 00 241 luz cálida	<b>AINHOA LED</b> Referencia 400 00 151 luz fría	<b>NIKITA LED</b> Referencia 400 01 171 luz fría	<b>NAYRA LED</b> Referencia 400 00 181 luz fría	<b>Aplique SKYLINE LED</b> cm Referencia 60 400 00 511 80 400 00 521 100 400 00 531 120 400 00 541	<b>Cornisa SKYLINE LED</b> cm Referencia 60 341 01 061 80 341 01 081 100 341 01 101 120 341 01 121 Mas colores en pág. 323
--	---	--	--	---	---	--



# Denim

\_60/80/100/120

- Sigma
- Omega
- Landes
- Landes modular
- Strip
- Cairo
- Dúo
- Ikaro
- Denim**
- Lip
- Wave
- Sky
- Trent
- Escorpio
- Tauro
- Wood
- Mar
- Hole
- Aries
- Galsaky
- Small
- Homy
- Comet
- Tívoli
- Moon
- Dominó



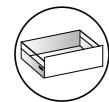

Interior cajones costilla metálicas  
Metal interior drawers  
Interior calaix costella metálica  
Kaxoi barnekaldea saihets metalikoekin  
Interior caixons costela metálica

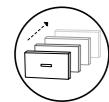

Cajón con cierre amortiguado  
Drawer fitted with soft closing system  
Gaveta com sistema de corrediças com amortecedor  
Calaixos amb sistema de tancament suau  
Motelgailudun itxierazko kajoia  
Caiçon con peche amortecido



Puerta con cierre amortiguado  
Door with soft closing system  
Porta com amortecedor  
Porta amb sistema de tancament suau  
Motelgailudun itxierazko atea  
Porta con peche amortecido

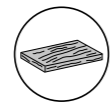

Acabado melamina con textura  
Textured melamine finish  
Cor melamina com textura  
Acabat melamina amb textura  
Testuradun melanina bukatua  
Acabado melanina con textura

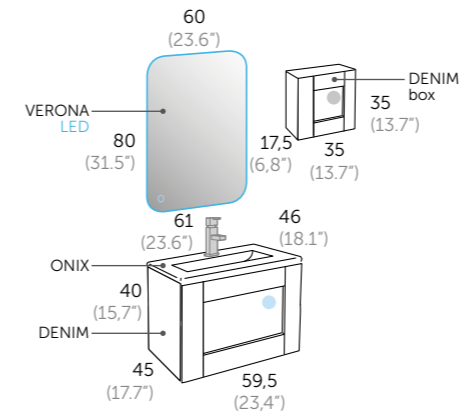

Composición **DENIM 60** (23.6")

- 1 111 26 060 DENIM 60
- 1 500 01 060 ONIX
- 1 246 00 060 VERONA LED

Auxiliares

- 1 111 26 435 DENIM box



Sistema antivaho  
Anti fog system  
Sistema anti-vapor  
Sistema anti-baf  
Lurrunaren kontrako sistema  
Sistema antivaho



Sensor de contacto On/ Off  
Contact sensor On/ Off  
Sensor interruptor On/ Off  
Sensor de contacte On/ Off  
On/Off kontaktu sentsorea  
Sensor de contacto On/ Off

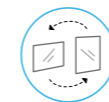

Reversible  
It is reversible  
Reversible  
Reversible  
Itzulgarria  
Reversible



Luz ambiental  
Ambient light  
Luz ambiente  
Llum ambiental  
Giro-argia  
Luz ambiental

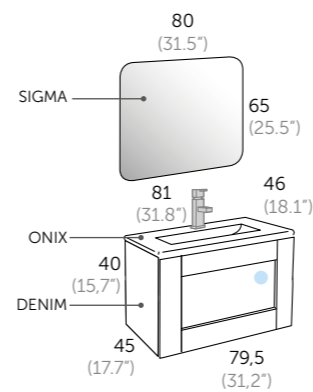

Composición **DENIM 80** (31.5")

- 1 111 26 080 DENIM 80
- 1 500 01 080 ONIX
- 1 290 00 080 SIGMA



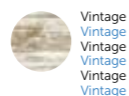

Vintage  
Vintage  
Vintage  
Vintage  
Vintage

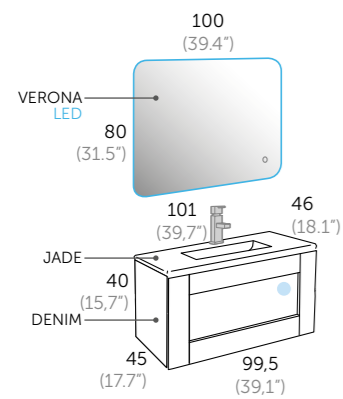

Composición **DENIM 100** (39.4")

- 1 111 26 100 DENIM 100
- 1 504 01 100 JADE
- 1 246 00 100 VERONA LED

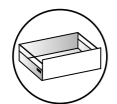

Interior cajones costilla metálicas  
*Metal interior drawers*  
Interior gaveta com guia metálica  
*Interior caixa costela metálica*  
Kaxoi barnekaldea saihets metalikoekin  
*Interior caixons costela metálica*

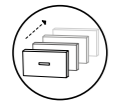

Cajón con cierre amortiguado  
*Drawer fitted with soft closing system*  
Gaveta com sistema de correções com amortecedor  
*Caixaos amb sistema de tancament suau*  
Motelgailudun itxierazko kajoia  
*Caixón con peche amortecido*



Acabado melamina con textura  
*Textured melamine finish*  
Cor melamina com textura  
*Acabat melamina amb textura*  
Testuradun melamina bukatua  
*Acabado melamina con textura*



Sistema antivaho  
*Anti fog system*  
Sistema anti-vapor  
*Sistema antibaf*  
Lurrunaren kontrako sistema  
*Sistema antivaho*



Sensor de contacto On/ Off  
*Contact sensor On/ Off*  
Sensor interruptor On/ Off  
*Sensor de contacte On/ Off*  
On/Off kontaktu sentsoarea  
*Sensor de contacto On/ Off*

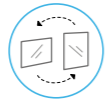

Reversible  
*It is reversible*  
Reversível  
*Reversible*  
Itzulgarria  
*Reversible*



Luz ambiental  
*Ambient light*  
Luz ambiente  
*Lum ambiental*  
Giro-argia  
*Luz ambiental*



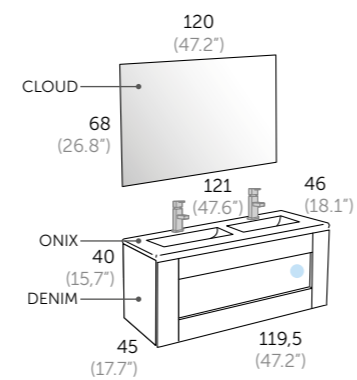

Composición **DENIM 120** (47.2")

- 1 111 26 120 DENIM 120
- 1 500 01 122 ONIX 120 doble
- 1 205 00 120 CLOUD

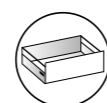

Interior cajones costilla metálicas  
*Metal interior drawers*  
Interior gaveta com guia metálica  
*Interior calaix costella metálica*  
Kaxoi barnekaldea saihets metalikoekin  
*Interior caixóns costela metálica*

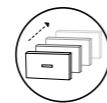

Cajón con cierre amortiguado  
*Drawer fitted with soft closing system*  
Gaveta com sistema de corrediças com amortecedor  
*Calaixos amb sistema de tancament suau*  
Motelgailudun itxierazko kajoia  
*Caixón con peche amortecido*

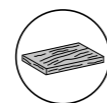

Acabado melamina con textura  
*Textured melamine finish*  
Cor melamina com textura  
*Acabat melamina amb textura*  
Testuradun melamina bukatua  
*Acabado melamina con textura*



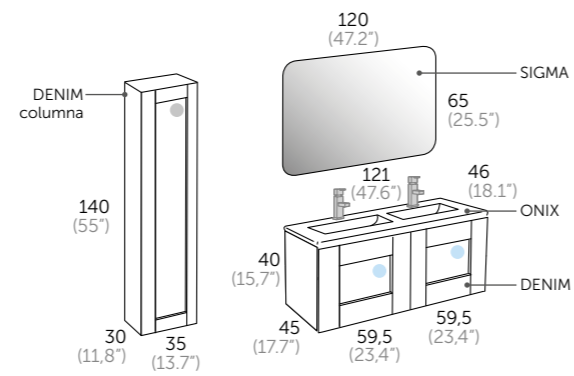

Composición **DENIM 120 (47.2") (60+60)**

- 2 111 26 060 DENIM 60
- 1 500 01 122 ONIX double
- 1 290 00 120 SIGMA

Auxiliares

- 1 111 26 335 DENIM columna

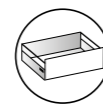

Interior cajones costilla metálicas  
*Metal interior drawers*  
Interior gaveta com guia metálica  
*Interior caixa costella metálica*  
Kaxoi barnekaldea saihets metalikoekin  
*Interior caixóns costela metálica*

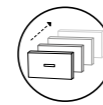

Cajón con cierre amortiguado  
*Drawer fitted with soft closing system*  
Gaveta com sistema de corrediças com amortecedor  
*Caixaios amb sistema de tancament suau*  
Motelgailudun itxierazko kajoia  
*Caixón con peche amortecido*

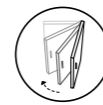

Puerta con cierre amortiguado  
*Door with soft closing system*  
Porta com amortecedor  
*Porta amb sistema de tancament suau*  
Motelgailudun itxierazko atea  
*Porta con peche amortecido*

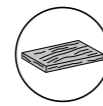

Acabado melamina con textura  
*Textured melamine finish*  
Cor melamina com textura  
*Acabat melamina amb textura*  
Testuradun melanina bukatua  
*Acabado melamina con textura*



## DENIM\_60 (23.6")

ESPEJOS Y CAMERINOS más opciones en págs. 316 - 325

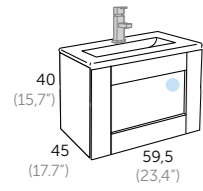

Acabado Referencia  
Vintage 111 26 060

### ENCIMERAS / countertops / lavatorios / lavabos / gaineoak / encimeras



<b>ONIX</b> cerámica Referencia 500 01 060	<b>TOPACIO</b> resina Referencia 505 01 060	<b>JADE</b> masa blanca Referencia 504 01 060	<b>MASAI</b> Referencia 518 02 060 Más colores en pág. 308-311	<b>CRISTAL</b> Acabado Metalizado Negro Referencia 502 11 060 Referencia 502 02 060
---	--	--	--	--

### ESPEJOS / mirrors / espelhos / miralls / ispiluak / espellos

### CAMERINOS armoires / armário com espelho / camerinos kamerinoak / camerinos /

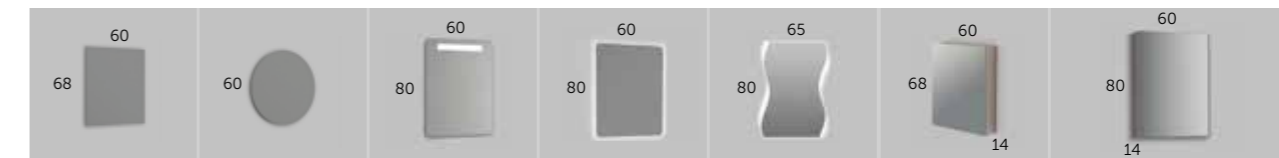

<b>CLOUD</b> Referencia 205 00 060	<b>REDONDO</b> Referencia 244 00 060	<b>RAIN LED</b> Referencia 269 00 060	<b>VERONA LED</b> Referencia 246 00 060	<b>MÓDENA LED</b> Referencia 264 00 080	<b>FLASH</b> Referencia 340 11 060	<b>SKYLINE</b> Referencia 341 11 060
---------------------------------------	---	--	--	--	---------------------------------------	---

## DENIM\_80 (31.5")

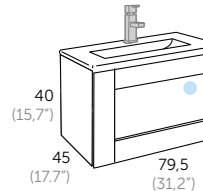

Acabado Referencia  
Vintage 111 26 080

### ENCIMERAS / countertops / lavatorios / lavabos / gaineoak / encimeras



<b>ONIX</b> cerámica Referencia 500 01 080	<b>TOPACIO</b> resina Referencia 505 01 080	<b>JADE</b> masa blanca Referencia 504 01 080	<b>AMBAR</b> mate Referencia 506 01 080	<b>MASAI</b> Referencia 518 02 080 Más colores en pág. 308-311	<b>CRISTAL</b> Acabado Metalizado Negro Referencia 502 11 080 Referencia 502 02 080
---	--	--	--	--	--

### ESPEJOS / mirrors / espelhos / miralls / ispiluak / espellos

### CAMERINOS armoires / armário com espelho / camerinos kamerinoak / camerinos /

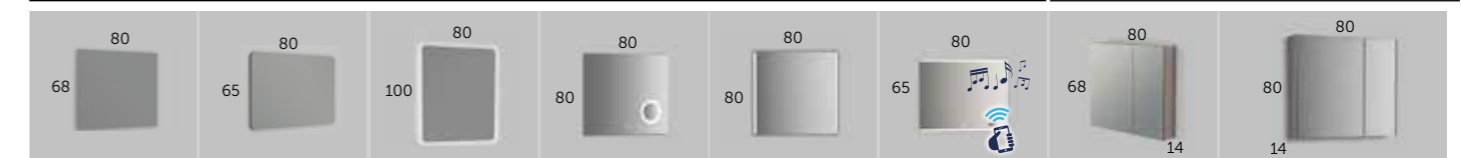

<b>CLOUD</b> Referencia 205 00 080	<b>SIGMA</b> Referencia 290 00 080	<b>VERONA LED</b> Referencia 246 00 100	<b>HOLMES LED</b> Referencia 263 00 080	<b>TOWER LED</b> Referencia 262 00 080	<b>SPOTY LED</b> Referencia 267 00 080	<b>FLASH</b> Referencia 340 11 080	<b>SKYLINE</b> Referencia 341 11 080
---------------------------------------	---------------------------------------	--	--	---	---	---------------------------------------	---

## DENIM\_100 (39.4")

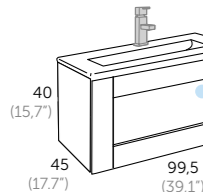

Acabado Referencia  
Vintage 111 26 100

### ENCIMERAS / countertops / lavatorios / lavabos / gaineoak / encimeras

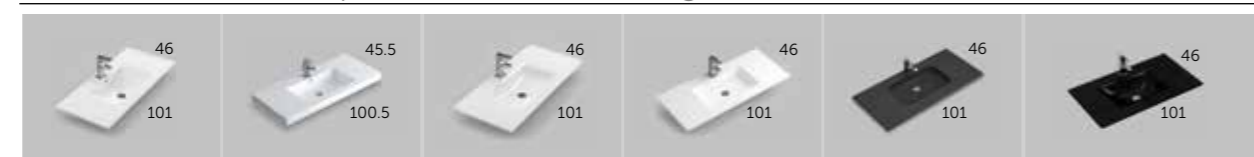

<b>ONIX</b> cerámica Referencia 500 01 100	<b>TOPACIO</b> resina Referencia 505 01 100	<b>JADE</b> masa blanca Referencia 504 01 100	<b>AMBAR</b> mate Referencia 506 01 100	<b>MASAI</b> Referencia 518 02 100 Más colores en pág. 308-311	<b>CRISTAL</b> Acabado Metalizado Negro Referencia 502 11 100 Referencia 502 02 100
---	--	--	--	--	--

### ESPEJOS / mirrors / espelhos / miralls / ispiluak / espellos

### CAMERINOS

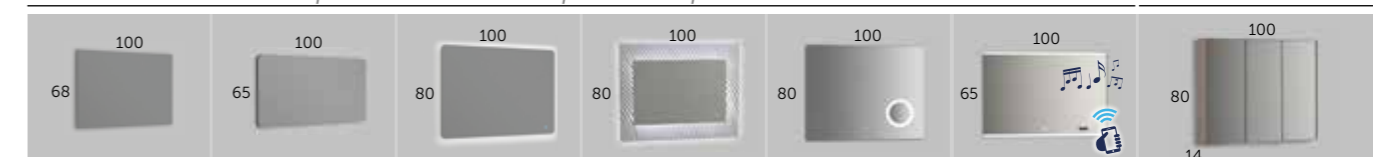

<b>CLOUD</b> Referencia 205 00 100	<b>SIGMA</b> Referencia 290 00 100	<b>VERONA LED</b> Referencia 246 00 100	<b>CEBRA LED</b> Referencia 265 00 100	<b>HOLMES LED</b> Referencia 263 00 100	<b>SPOTY LED</b> Referencia 267 00 100	<b>SKYLINE</b> Referencia 341 11 100
---------------------------------------	---------------------------------------	--	---	--	---	---

## DENIM\_120 (47.2")

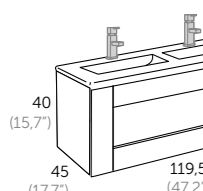

Acabado Referencia  
Vintage 111 26 120

### ENCIMERAS / countertops / lavatorios / lavabos / gaineoak / encimeras

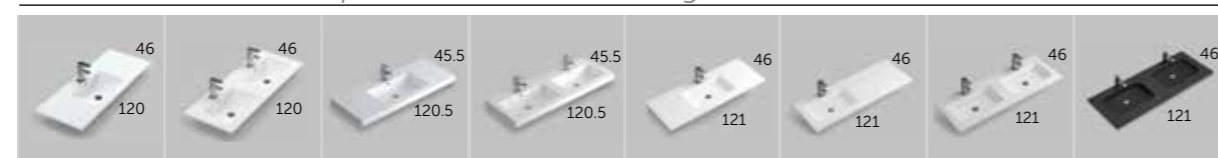

<b>ONIX</b> cerámica Referencia 500 01 120	<b>ONIX</b> cerámica Referencia 500 01 122	<b>TOPACIO</b> Referencia 505 01 120	<b>TOPACIO</b> Referencia 505 01 122	<b>AMBAR</b> Referencia 506 01 120	<b>AMBAR</b> Referencia 506 01 121	<b>AMBAR</b> Referencia 506 01 122	<b>MASAI</b> Referencia 518 02 122 Más colores en pág. 308-311
---	---	---	---	---------------------------------------	---------------------------------------	---------------------------------------	--

### ESPEJOS / mirrors / espelhos / miralls / ispiluak / espellos

### CAMERINOS armoires / armário com espelho / camerinos kamerinoak / camerinos /

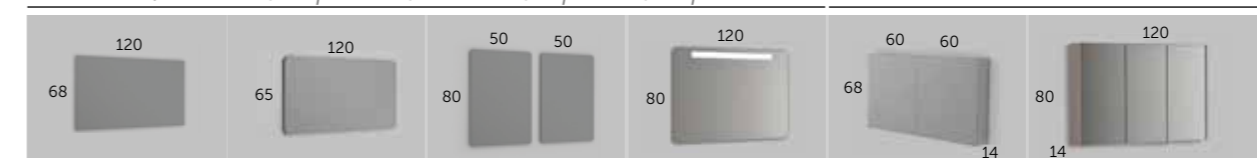

<b>CLOUD</b> Referencia 205 00 120	<b>SIGMA</b> Referencia 290 00 120	<b>NITRO</b> Referencia 241 00 050	<b>RAIN LED</b> Referencia 269 00 120	<b>FLASH</b> Referencia 340 11 060	<b>SKYLINE</b> Referencia 341 11 120
---------------------------------------	---------------------------------------	---------------------------------------	--	---------------------------------------	---

## AUXILIARES / auxiliary units / auxiliares / auxiliars / osagarriak / auxiliares

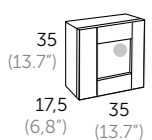

**DENIM box**  
Acabado Referencia  
Vintage 111 26 435

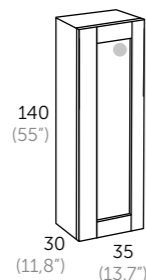

**DENIM column**  
Acabado Referencia  
Vintage 111 26 335



**Válvula universal CLIC CLAC**  
Referencia 51601

## APLIQUES / spotlights / apliques / aplics / ezarkinak / apliques



<b>ESTHER LED</b> Referencia 400 00 121 luz fría Referencia 400 00 221 luz cálida	<b>SOFIA LED</b> Referencia 400 00 141 luz fría Referencia 400 00 241 luz cálida	<b>AINHOA LED</b> Referencia 400 00 151 luz fría	<b>NIKITA LED</b> Referencia 400 01 171 luz fría	<b>NAYRA LED</b> Referencia 400 00 181 luz fría	<b>Aplique SKYLINE LED</b> cm Referencia 60 400 00 511 80 400 00 521 100 400 00 531 120 400 00 541	<b>Cornisa SKYLINE LED</b> cm Referencia 60 341 11 061 80 341 11 081 100 341 11 101 120 341 11 121 Más colores en pág. 323
---	--	--	--	---	---	--

Sigma  
Omega  
Landes  
Landes modular  
Strip  
Cairo  
Dúo  
Ikaro  
Denim  
**Lip\_**  
Wave  
Sky  
Trent  
Escorpio  
Tauro  
Wood  
Mar  
Hole  
Aries  
Galsaky  
Small  
Homy  
Comet  
Tivoli  
Moon  
Dominó

# Lip

\_80/100/120





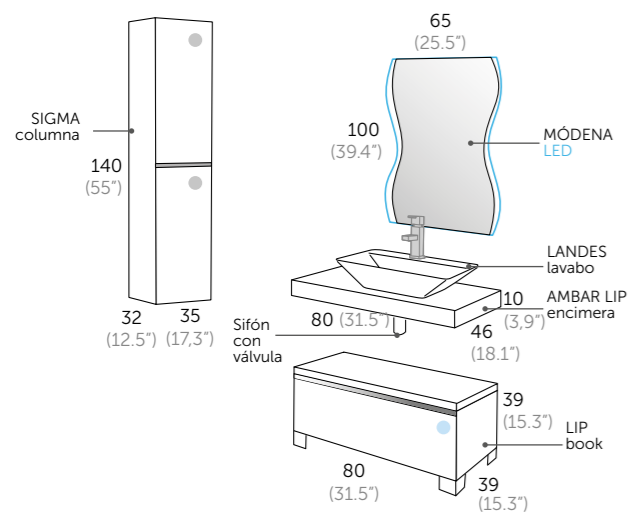

Composición **LIP 80 (31.5")**

- 1 524 01 081 AMBAR LIP encimera 80
- 1 108 35 208 LIP Book 80
- 1 410 00 101 Sifón con válvula
- 1 507 01 002 LANDES lavabo
- 1 264 20 100 MÓDENA LED

Auxiliares

- 1 190 01 340 SIGMA columna

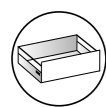
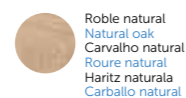
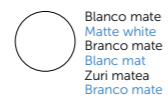

Interior cajones costilla metálicas  
Metal interior drawers  
Interior gaveta com guia metálica  
Interior calaix costella metálica  
Kaxoi barnekaldea saihets metalikoekin  
Interior caixóns costela metálica

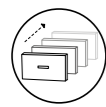

Cajón con cierre amortiguado  
Drawer fitted with soft closing system  
Gaveta com sistema de corrediças com amortecedor  
Calaixos amb sistema de tancament suau  
Motelgailudun itxierazko kajoia  
Caixón con peche amortecido



Guías Hettich  
Hettich drawer sliding system  
Guias Hettich  
Guias Hettich  
Hettich gidak  
Guias Hettich



Hidrófugo  
More resistant to water  
A prova d'água  
Hidrófug  
Hidrofugoa  
Hidrófugo

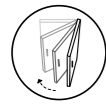

Puerta con cierre amortiguado  
Door with soft closing system  
Porta com amortecedor  
Porta amb sistema de tancament suau  
Motelgailudun itxierazko atea  
Porta con peche amortecido



Sistema antivaho  
Anti fog system  
Sistema anti-vapor  
Sistema antibaf  
Lurrunaren kontrako sistema  
Sistema antivaho



Sensor de contacto On/ Off  
Contact sensor On/ Off  
Sensor interruptor On/ Off  
Sensor de contacte On/ Off  
On/Off kontaktu sentsorea  
Sensor de contacto On/ Off

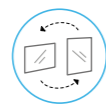

Reversible  
It is reversible  
Reversible  
Reversible  
Itzulgarria  
Reversible



Luz ambiental  
Ambient light  
Luz ambiente  
Llum ambiental  
Giro-argia  
Luz ambiental





Toallero opcional

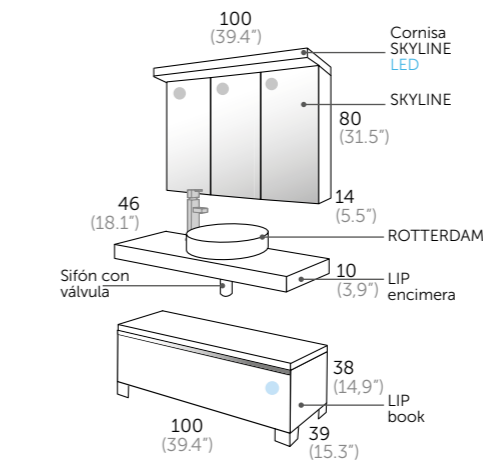



Composición **LIP 100 (39")**

- 1 108 24 100 LIP encimera 100
- 1 108 24 210 LIP Book 100
- 1 507 01 004 ROTTERDAM
- 1 410 00 101 Sifón con válvula
- 1 341 24 100 SKYLINE
- 1 341 24 101 Cornisa SKYLINE LED



-  Interior cajones costilla metálicas  
*Metal interior drawers*  
Interior gaveta com guia metálica  
Interior calaix costella metàl·lica  
Kaxoi barnekaldea saihets metalikoekin  
Interior caixons costela metàlica
-  Cajón con cierre amortiguado  
*Drawer fitted with soft closing system*  
Gaveta com sistema de corredeiras com amortecedor  
Calaixos amb sistema de tancament suau  
Motelgailudun itxierazko kajoia  
Caixon con peche amortecido
-  Puerta con cierre amortiguado  
*Door with soft closing system*  
Porta com amortecedor  
Porta amb sistema de tancament suau  
Motelgailudun itxierazko atea  
Porta con peche amortecido
-  Guías Hettich  
*Hettich drawer sliding system*  
Guias Hettich  
Guias Hettich  
Hettich gidak  
Guias Hettich
-  Acabado melamina con textura  
*Textured melamine finish*  
Cor melamina com textura  
Acabat melamina amb textura  
Testuradun melamina bukatua  
Acabado melamina con textura
-  Hidrófugo  
*More resistant to water*  
À prova d'água  
Hidrófug  
Hidrofugoa  
Hidrófugo

-  Blanco mate  
*Matte white*  
Branco mate  
Blanc mat  
Zuri matea  
Branco mate
-  Roble natural  
*Natural oak*  
Carvalho natural  
Roure natural  
Haritz naturala  
Carballo natural



Toallero integrado opcional

- Blanco mate
- Matte white
- Branco mate
- Blanc mat
- Zuri matea
- Branco mate

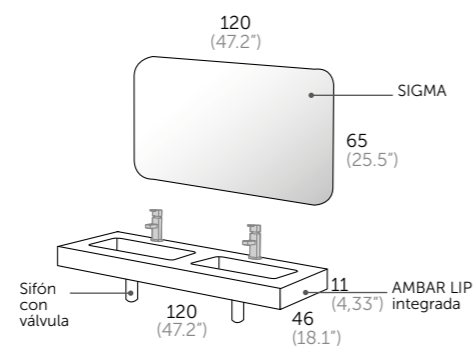

Composición **LIP 120 (47.2")**

- 1 524 01 120 AMBAR LIP integrada
- 1 290 00 120 SIGMA
- 2 410 00 101 Sifón con válvula



## LIP\_80 (31.5")

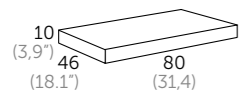

**AMBAR LIP encimera**  
con soportes invisibles  
Acabado Referencia  
 Solid surface 524 01 081  
Blanco mate



**LIP encimera**  
con soportes invisibles  
Acabado Referencia  
 Roble natural 108 24 080

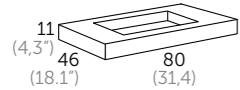

**AMBAR LIP integrada**  
con soportes invisibles  
Acabado Referencia  
 Solid surface 524 01 080  
Blanco mate

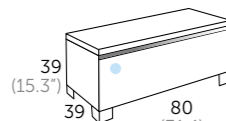

**BOOK LIP**  
Referencia  
 108 35 208  
 108 24 208

## LIP\_100 (39.4")

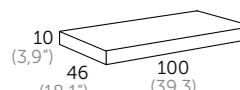

**AMBAR LIP encimera**  
con soportes invisibles  
Acabado Referencia  
 Solid surface 524 01 101  
Blanco mate



**LIP encimera**  
con soportes invisibles  
Acabado Referencia  
 Roble natural 108 24 100

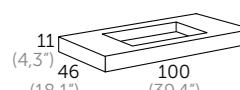

**AMBAR LIP integrada**  
con soportes invisibles  
Acabado Referencia  
 Solid surface 524 01 100  
Blanco mate

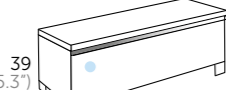

**BOOK LIP**  
Referencia  
 108 35 210  
 108 24 210

## LIP\_120 (47.2")

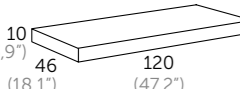

**AMBAR LIP encimera**  
con soportes invisibles  
Acabado Referencia  
 Solid surface 524 01 121  
Blanco mate



**LIP encimera**  
con soportes invisibles  
Acabado Referencia  
 Roble natural 108 24 120

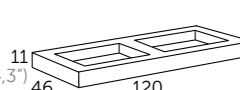

**AMBAR LIP integrada**  
con soportes invisibles  
Acabado Referencia  
 Solid surface 524 01 120  
Blanco mate



**BOOK LIP**  
Referencia  
 108 35 220  
 108 24 220

## AUXILIARES / auxiliary units / auxiliares / auxiliars / osagarriak / auxiliares

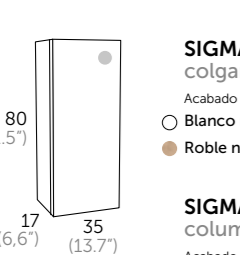

**SIGMA colgar**  
Acabado Referencia  
 Blanco mate 190 01 435  
 Roble natural 190 24 435



**SIGMA columna**  
Acabado Referencia  
 Blanco mate 190 01 340  
 Roble natural 190 24 340

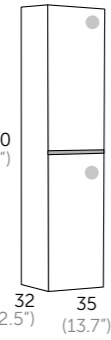

**LIP toallero**  
para encimera de madera  
Referencia  
cromo 416 00 002



**Toallero opcional**  
para ambar lip  
Referencia  
524 01 999

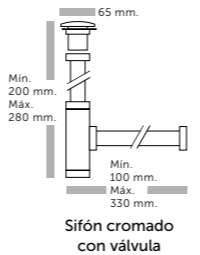

**Sifón cromado con válvula**  
Referencia  
410 00 101

## LAVABOS / washbasins / lavatorio pousar / lavabo sobreposar / gainjarritako konketa / lavabo sobrepoñer

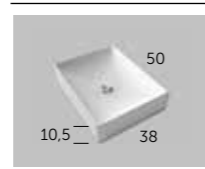

**ESTAMBUL**  
Referencia  
507 01 005  
Altura 10,5 cm

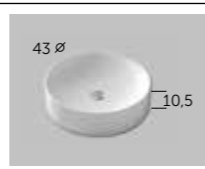

**ROTTERDAM**  
Referencia  
507 01 004  
Altura 10,5 cm



**AMBERES**  
Referencia  
507 01 003  
Altura 12,5



**LANDES**  
Referencia  
507 01 002  
Altura 13

más opciones en págs. 314 - 315

## LAVABOS / washbasins / lavatorio pousar / lavabo sobreposar / gainjarritako konketa / lavabo sobrepoñer

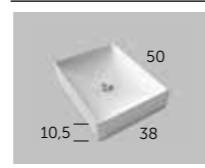

**ESTAMBUL**  
Referencia  
507 01 005  
Altura 10,5 cm

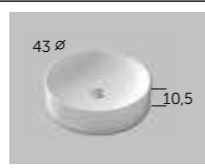

**ROTTERDAM**  
Referencia  
507 01 004  
Altura 10,5 cm



**AMBERES**  
Referencia  
507 01 003  
Altura 12,5



**LANDES**  
Referencia  
507 01 002  
Altura 13

más opciones en págs. 314 - 315

## LAVABOS / washbasins / lavatorio pousar / lavabo sobreposar / gainjarritako konketa / lavabo sobrepoñer

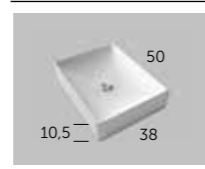

**ESTAMBUL**  
Referencia  
507 01 005  
Altura 10,5 cm

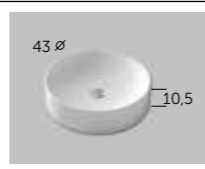

**ROTTERDAM**  
Referencia  
507 01 004  
Altura 10,5 cm

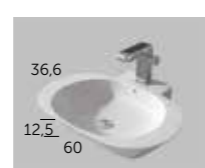

**AMBERES**  
Referencia  
507 01 003  
Altura 12,5



**LANDES**  
Referencia  
507 01 002  
Altura 13

más opciones en págs. 314 - 315

## ESPEJOS / mirrors / espelhos / miralls / ispiluak / espellos

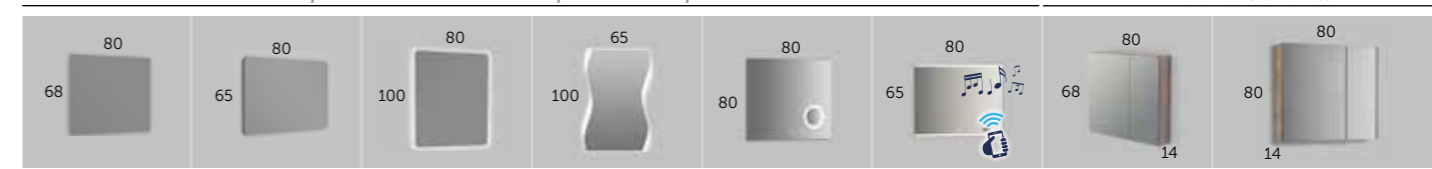

**CLOUD**  
Referencia  
205 00 080

**SIGMA**  
Referencia  
290 00 080

**VERONA LED**  
Referencia  
246 00 100

**MÓDENA LED**  
Referencia  
264 00 100

**HOLMES LED**  
Referencia  
263 00 080

**SPOTY LED**  
Referencia  
267 00 080

**FLASH**  
Referencia  
340 11 080

**SKYLINE**  
Referencia  
 341 24 080  
 341 11 080

## CAMERINOS / armóires / armário com espelho / camerinos / kamerinoak / camerinos /

## ESPEJOS / mirrors / espelhos / miralls / ispiluak / espellos

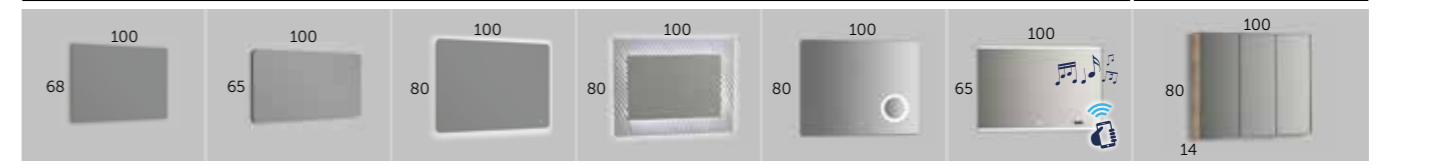

**CLOUD**  
Referencia  
205 00 100

**SIGMA**  
Referencia  
290 00 100

**VERONA LED**  
Referencia  
246 00 100

**CEBRA LED**  
Referencia  
265 00 100

**HOLMES LED**  
Referencia  
263 00 100

**SPOTY LED**  
Referencia  
267 00 100

**SKYLINE**  
Referencia  
 341 24 100  
 341 11 100

## CAMERINOS / armóires / armário com espelho / camerinos / kamerinoak / camerinos /

## ESPEJOS / mirrors / espelhos / miralls / ispiluak / espellos

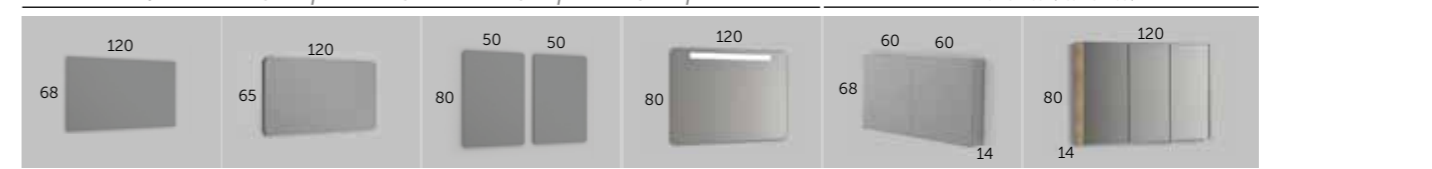

**CLOUD**  
Referencia  
205 00 120

**SIGMA**  
Referencia  
290 00 120

**NITRO**  
Referencia  
241 00 050

**RAIN LED**  
Referencia  
269 00 120

**FLASH**  
Referencia  
340 11 060

**SKYLINE**  
Referencia  
 341 24 120  
 341 11 120

## APLIQUES / spotlights / apliques / aplics / ezarkinak / apliques



**ESTHER LED**  
Referencia  
400 00 121  
luz fría  
400 00 221  
luz cálida

**SOFIA LED**  
Referencia  
400 00 141  
luz fría  
400 00 241  
luz cálida

**AINHOA LED**  
Referencia  
400 00 151  
luz fría

**NIKITA LED**  
Referencia  
400 01 171  
luz fría

**NAYRA LED**  
Referencia  
400 00 181  
luz fría

**Aplique SKYLINE LED**  
cm Referencia  
60 400 00 511  
80 400 00 521  
100 400 00 531  
120 400 00 541

**Cornisa SKYLINE LED**  
cm Referencia  
60 341 24 061  
80 341 24 081  
100 341 24 101  
120 341 24 121

Más colores en pág. 323

# Wave

\_60/80/100

Sigma  
Omega  
Landes  
Landes modular  
Strip  
Cairo  
Dúo  
Ikaro  
Denim  
Lip  
**Wave\_**  
Sky  
Trent  
Escorpio  
Tauro  
Wood  
Mar  
Hole  
Aries  
Galsaky  
Small  
Homy  
Comet  
Tivoli  
Moon  
Dominó





Blanco  
White  
Branco  
Blanc  
Zuria  
Branco

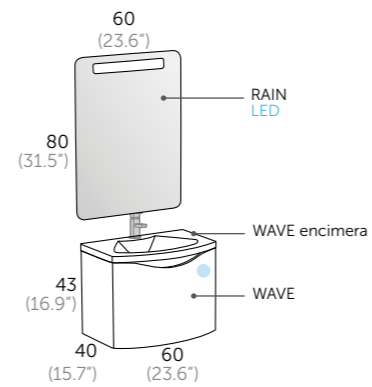

Composición **WAVE 60 (23.6'')**

- 1 116 01 060 WAVE 60
- 1 516 01 060 WAVE encimera
- 1 269 00 060 RAIN LED

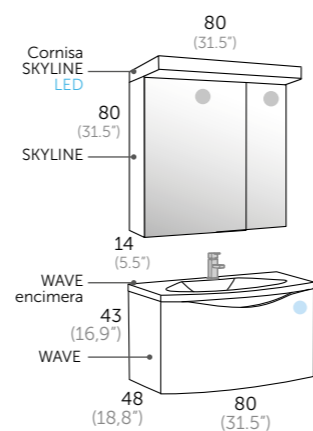

Composición **WAVE 80 (31.5'')**

- 1 116 01 080 WAVE 80
- 1 516 01 080 WAVE encimera
- 1 341 01 080 SKYLINE
- 1 341 01 081 Cornisa SKYLINE LED

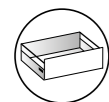

Interior cajones costilla metálicas  
Metal interior drawers  
Interior gaveta com guia metálica  
Interior calaix costella metálica  
Kaxoi barnekaldea saihets metalikoekin  
Interior caixóns costela metálica

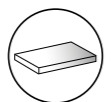

Acabado lacado brillo  
High gloss lacquered finish  
Cor lacado brilhó  
Acabat lacat brillant  
Distiradun lakatzko bukaturia  
Acabado lacado brilho



Cajón con cierre amortiguado  
Drawer fitted with soft closing system  
Gaveta com sistema de corrediças com amortecedor  
Calaixos amb sistema de tancament suau  
Motelgailudun itxierazko kajoia  
Caixón con peche amortecido



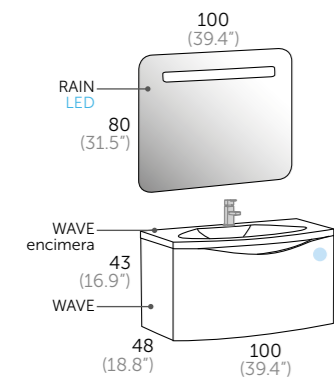

Composición **WAVE 100 (39")**

- 1 116 01 100 WAVE 100
- 1 516 01 100 WAVE encimera
- 1 269 00 100 RAIN LED

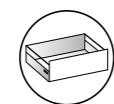

Interior cajones costilla metálica  
*Metal interior drawers*  
 Interior gaveta com guia metálica  
*Interior caixa costella metálica*  
 Kaxoi barnekaldea saihets metalikoeikin  
*Interior caixons costela metálica*

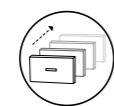

Cajón con cierre amortiguado  
*Drawer fitted with soft closing system*  
 Gaveta com sistema de correções com amortecedor  
*Caixaos amb sistema de tancament suau*  
 Motelgailudun itxierazko kajoia  
*Caixón con peche amortecido*

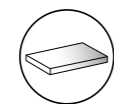

Acabado lacado brillo  
*High gloss lacquered finish*  
 Cor lacado brilho  
*Acabat lacat brillant*  
 Distiradun lakatzuko bukatua  
*Acabado lacado brillo*



## WAVE\_60 (23.6")

ESPEJOS Y CAMERINOS más opciones en págs. 316 - 325

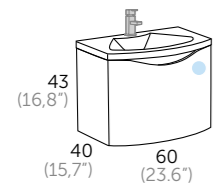

Acabado Referencia  
○ Blanco 116 01 060

### ENCIMERA / countertop / lavatorio / lavabo / gaineakoak / encimera



**WAVE**  
Referencia  
516 01 060

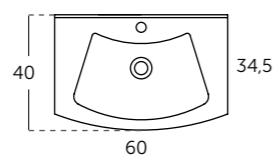

## WAVE\_80 (31.5")

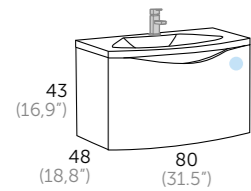

Acabado Referencia  
○ Blanco 116 01 080

### ENCIMERA / countertop / lavatorio / lavabo / gaineakoak / encimera

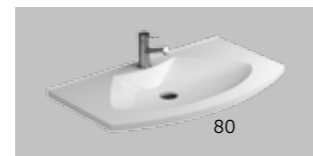

**WAVE**  
Referencia  
516 01 080

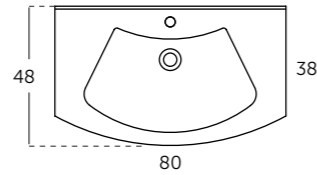

## WAVE\_100 (39.4")

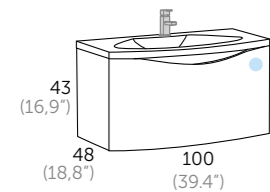

Acabado Referencia  
○ Blanco 116 01 100

### ENCIMERA / countertop / lavatorio / lavabo / gaineakoak / encimera

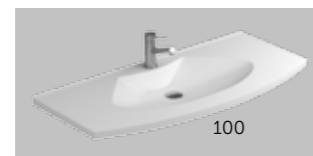

**WAVE resina**  
Referencia  
516 01 100

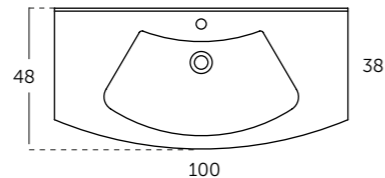

### ESPEJOS / mirrors / espelhos / miralls / ispiluak / espellos

### CAMERINOS armoires / armário com espelho / camerinos kamerinoak / camerinos /



<b>CLOUD</b> Referencia 205 00 060	<b>REDONDO</b> Referencia 244 00 060	<b>TOOL</b> Referencia ○ 207 01 060	<b>RAIN LED</b> Referencia 269 00 060	<b>VERONA LED</b> Referencia 246 00 060	<b>MÓDENA LED</b> Referencia 264 00 080	<b>FLASH</b> Referencia 340 11 060	<b>SKYLINE</b> Referencia ○ 341 01 060
--	--	---	---	---	---	--	--

### ESPEJOS / mirrors / espelhos / miralls / ispiluak / espellos

### CAMERINOS armoires / armário com espelho / camerinos kamerinoak / camerinos /



<b>CLOUD</b> Referencia 205 00 080	<b>SIGMA</b> Referencia 290 00 080	<b>RAIN LED</b> Referencia 269 00 080	<b>VERONA LED</b> Referencia 246 00 100	<b>HOLMES LED</b> Referencia 263 00 080	<b>SPOTY LED</b> Referencia 267 00 080	<b>FLASH</b> Referencia 340 11 080	<b>SKYLINE</b> Referencia ○ 341 01 080
--	--	---	---	---	--	--	--



### ESPEJOS / mirrors / espelhos / miralls / ispiluak / espellos

### CAMERINOS

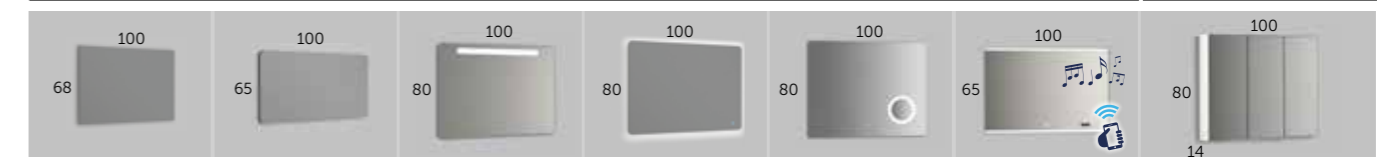

<b>CLOUD</b> Referencia 205 00 100	<b>SIGMA</b> Referencia 290 00 100	<b>RAIN LED</b> Referencia 269 00 100	<b>VERONA LED</b> Referencia 246 00 100	<b>HOLMES LED</b> Referencia 263 00 100	<b>SPOTY LED</b> Referencia 267 00 100	<b>SKYLINE</b> Referencia ○ 341 01 100
--	--	---	---	---	--	--

### APLIQUES / spotlights / apliques / aplics / ezarkinak / apliques



<b>ESTHER LED</b> Referencia 400 00 121 luz fría 400 00 221 luz cálida	<b>SOFIA LED</b> Referencia 400 00 141 luz fría 400 00 241 luz cálida	<b>AINHOA LED</b> Referencia 400 00 151 luz fría	<b>NIKITA LED</b> Referencia 400 01 171 luz fría	<b>NAYRA LED</b> Referencia 400 00 181 luz fría	<b>Aplique SKYLINE LED</b> cm Referencia 60 400 00 511 80 400 00 521 100 400 00 531 120 400 00 541	<b>Cornisa SKYLINE LED</b> cm Referencia 60 341 01 061 80 341 01 081 100 341 01 101 120 341 01 121 Más colores en pág. 323
---	--	---	---	--	---	--



**Válvula universal  
CLIC CLAC**  
Referencia  
51601



# Sky\_60/80/100/120

- Sigma
- Omega
- Landes
- Landes modular
- Strip
- Cairo
- Dúo
- Ikaro
- Denim
- Lip
- Wave
- Sky\_**
- Trent
- Escorpio
- Tauro
- Wood
- Mar
- Hole
- Aries
- Galsaky
- Small
- Homy
- Comet
- Tívoli
- Moon
- Dominó

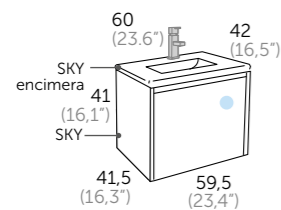

Composición **SKY 60** (23.6")

- 1 117 01 060 SKY
- 1 517 01 060 SKY encimera







Blanco  
White  
Branco  
Blanc  
Zuria  
Branco

Blanco  
White  
Branco  
Blanc  
Zuria  
Branco

 Sistema antivaho  
Anti fog system  
Sistema anti-vapor  
Sistema antiñaf  
Lurrunaren kontrako sistema  
Sistema antivaho

 Reloj digital  
Digital clock  
Relogio digital  
Rellojge digital  
Erlujo digitala  
Reloxo dixital

 Sensor de contacto On/ Off  
Contact sensor On/ Off  
Sensor interruptor On/ Off  
Sensor de contacte On/ Off  
On/Off kontaktu sensoresa  
Sensor de contacto On/ Off

 Lupa aumento x3  
Magnifying zoom in Mirror  
Lupa aumento 3x  
Lupa augment x3  
3x-eko haundiagotze lupa  
Lupa aumento x3

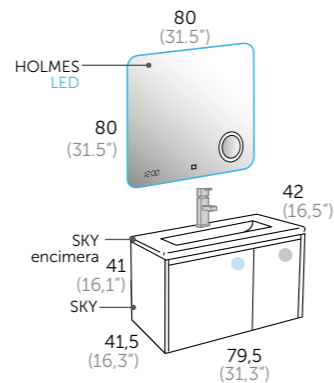



Composición **SKY 80** (31.5")

- 1 117 01 080 SKY
- 1 517 01 080 SKY encimera
- 1 263 00 080 HOLMES LED



 Interior cajones costilla metálicas  
Metal interior drawers  
Interior gaveta com guia metálica  
Interior calaix costella metàlica  
Kaxoi barnekaldea saihets metalikoekin  
Interior caixóns costela metàlica

 Cajón con cierre amortiguado  
Drawer fitted with soft closing system  
Gaveta com sistema de correções com amortecedor  
Calaixos amb sistema de tancament suau  
Motelgailudun itxierazko kajoia  
Caixón con peche amortecido

 Acabado lacado brillo  
High gloss lacquered finish  
Cor lacado brilho  
Acabat lacat brillant  
Distiradun lakatzuko bukatua  
Acabado lacado brillo

 Puerta con cierre amortiguado  
Door with soft closing system  
Porta com amortecedor  
Porta amb sistema de tancament suau  
Motelgailudun itxierazko atea  
Porta con peche amortecido

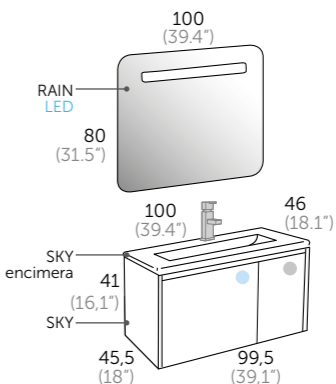

Composición **SKY 100** (39.4")

- 1 117 01 100 SKY
- 1 517 01 100 SKY encimera
- 1 269 00 100 RAIN LED





Blanco  
White  
Branco  
Blanc  
Zuria  
Branco

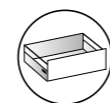

Interior cajones costilla metálicas  
*Metal interior drawers*  
Interior gaveta com guia metálica  
*Interior calaix costella metálica*  
Kaxoi barnekaldea saihets metalikoekin  
*Interior caixons costela metálica*



Cajón con cierre amortiguado  
*Drawer fitted with soft closing system*  
Gaveta com sistema de corrediças com amortecedor  
*Caixaos amb sistema de tancament suau*  
Motelgailudun itxierazko kajoia  
*Caixon con peche amortecido*

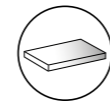

Acabado lacado brillo  
*High gloss lacquered finish*  
Cor lacado brilho  
*Acabat lacat brillant*  
Distiradun lakatzuzko bukatua  
*Acabado lacado brillo*

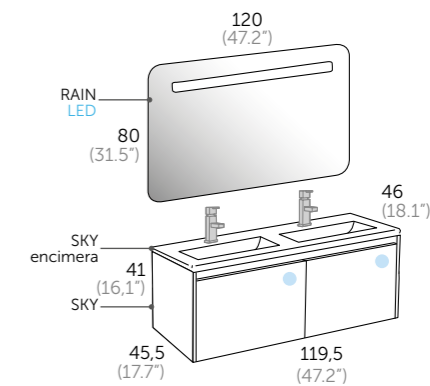

Composición **SKY 120 (47.2")**

- 1 117 01 120 SKY
- 1 517 01 120 SKY encimera
- 1 269 00 120 RAIN LED



## SKY\_60 (23.6")

ESPEJOS Y CAMERINOS más opciones en págs. 316 - 325

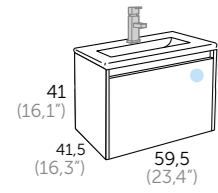

Acabado Referencia  
○ Blanco 117 01 060

### ENCIMERA / countertop / lavatorio / lavabo / gaineoak / encimera



#### SKY

Referencia  
517 01 060

## SKY\_80 (31.5")

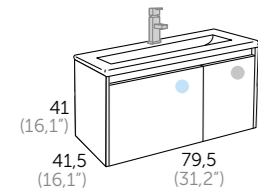

Acabado Referencia  
○ Blanco 117 01 080

### ENCIMERA / countertop / lavatorio / lavabo / gaineoak / encimera



#### SKY

Referencia  
517 01 080

## SKY\_100 (39.4")

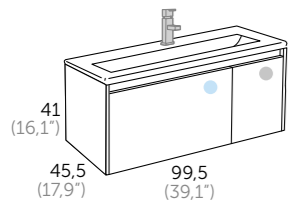

Acabado Referencia  
○ Blanco 117 01 100

### ENCIMERA / countertop / lavatorio / lavabo / gaineoak / encimera



#### SKY

Referencia  
517 01 100

## SKY\_120 (47.2")

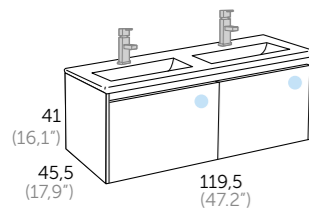

Acabado Referencia  
○ Blanco 117 01 120

### ENCIMERA / countertop / lavatorio / lavabo / gaineoak / encimera



#### SKY

Referencia  
517 01 120



#### Vátvula universal CLIC CLAC

Referencia  
51601

### ESPEJOS / mirrors / espelhos / miralls / ispiluak / espellos

### CAMERINOS armoires / armário com espelho / camerinos kamerinoak / camerinos /



#### CLOUD

Referencia  
205 00 060

#### REDONDO

Referencia  
244 00 060

#### TOOL

Referencia  
○ 207 01 060

#### RAIN LED

Referencia  
269 00 060

#### VERONA LED

Referencia  
246 00 060

#### MÓDENA LED

Referencia  
264 00 080

#### FLASH

Referencia  
340 11 060

#### SKYLINE

Referencia  
○ 341 01 060

### ESPEJOS / mirrors / espelhos / miralls / ispiluak / espellos

### CAMERINOS armoires / armário com espelho / camerinos kamerinoak / camerinos /

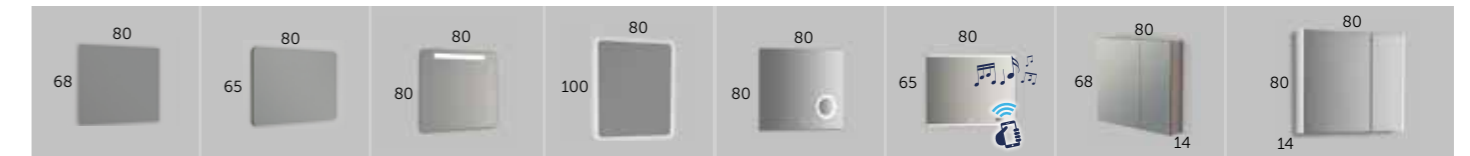

#### CLOUD

Referencia  
205 00 080

#### SIGMA

Referencia  
290 00 080

#### RAIN LED

Referencia  
269 00 080

#### VERONA LED

Referencia  
246 00 100

#### HOLMES LED

Referencia  
263 00 080

#### SPOTY LED

Referencia  
267 00 080

#### FLASH

Referencia  
340 11 080

#### SKYLINE

Referencia  
○ 341 01 080

### ESPEJOS / mirrors / espelhos / miralls / ispiluak / espellos

### CAMERINOS

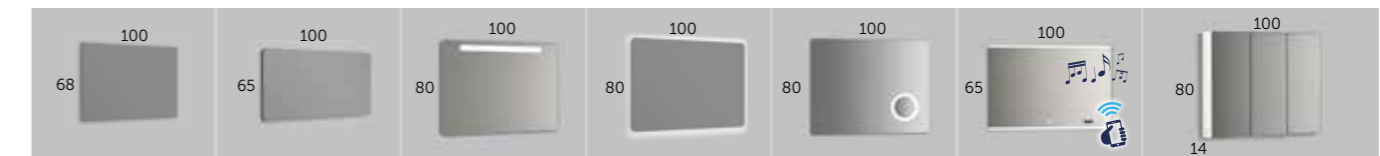

#### CLOUD

Referencia  
205 00 100

#### SIGMA

Referencia  
290 00 100

#### RAIN LED

Referencia  
269 00 100

#### VERONA LED

Referencia  
246 00 100

#### HOLMES LED

Referencia  
263 00 100

#### SPOTY LED

Referencia  
267 00 100

#### SKYLINE

Referencia  
○ 341 01 100

### ESPEJOS / mirrors / espelhos / miralls / ispiluak / espellos

### CAMERINOS armoires / armário com espelho / camerinos kamerinoak / camerinos /

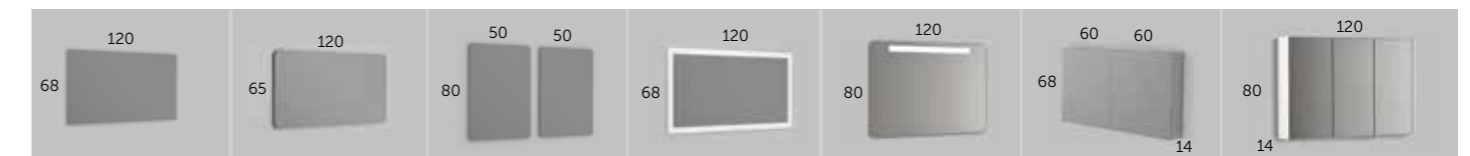

#### CLOUD

Referencia  
205 00 120

#### SIGMA

Referencia  
290 00 120

#### NITRO

Referencia  
241 00 050

#### TOOL

Referencia  
○ 207 01 120

#### RAIN LED

Referencia  
269 00 120

#### FLASH

Referencia  
340 11 060

#### SKYLINE

Referencia  
○ 341 01 120

### APLIQUES / spotlights / apliques / aplics / ezarkinak / apliques



#### ESTHER LED

Referencia  
400 00 121  
luz fría  
400 00 221  
luz cálida

#### SOFIA LED

Referencia  
400 00 141  
luz fría  
400 00 241  
luz cálida

#### AINHOA LED

Referencia  
400 00 151  
luz fría

#### NIKITA LED

Referencia  
400 01 171  
luz fría

#### NAYRA LED

Referencia  
400 00 181  
luz fría

#### Aplique SKYLINE LED

Referencia  
cm 400 00 511  
60 400 00 521  
80 400 00 531  
100 400 00 541  
120 400 00 541

#### Cornisa SKYLINE LED

Referencia  
cm 341 01 061  
60 341 01 081  
80 341 01 101  
100 341 01 121  
120 341 01 121

Más colores en pág. 323

# Trent

Sigma  
Omega  
Landes  
Landes modular  
Strip  
Cairo  
Dúo  
Ikaro  
Denim  
Lip  
Wave  
Sky

**Trent\_**  
Escorpio  
Tauro  
Wood  
Mar  
Hole  
Aries  
Galsaky  
Small  
Homy  
Comet  
Tívoli  
Moon  
Dominó

\_80/100



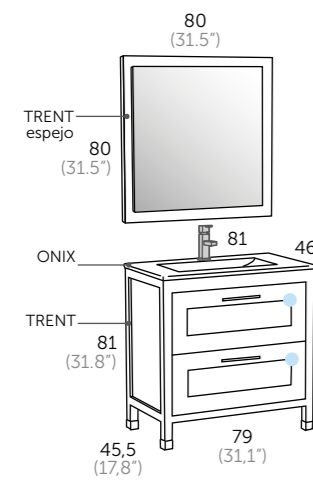

Composición **TREN 80** (31.5")

- 1 195 01 080 TREN 80
- 1 500 01 080 ONIX
- 1 295 01 080 TREN espejo

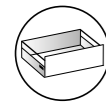

Interior cajones costilla metálicas  
*Metal interior drawers*  
 Interior gaveta com guia metálica  
*Interior caixa costela metálica*  
 Kaxoi barnekaldea saihets metalikoekin  
*Interior caixons costela metálica*

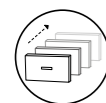

Cajón con cierre amortiguado  
*Drawer fitted with soft closing system*  
 Gaveta com sistema de correções com amortecedor  
*Caixas amb sistema de tançament suau*  
 Motelgailudun itxierazko kajoia  
*Caixón con peche amortecido*

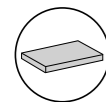

Acabado lacado mate  
*Matte lacquered finish*  
 Cor lacado mate  
*Acabat lacat mat*  
 Mate lakatzko bukatua  
*Acabado lacado mate*



Blanco mate  
 Matte white  
 Branco mate  
 Blanc mat  
 Zuri matea  
 Branco mate



Gris mate  
 Matte grey  
 Cinzento mate  
 Gris mat  
 Gris matea  
 Gris mate



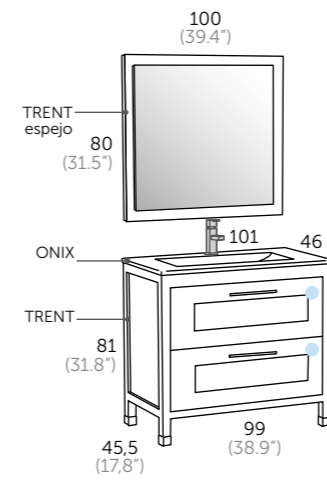

Composición **TRENT 100 (39.4")**

- 1 195 03 100 TRENTE 100
- 1 500 01 100 ONIX
- 1 295 03 100 TRENTE espejo



Interior cajones costilla metálicas  
*Metal interior drawers*  
 Interior gaveta com guia metálica  
*Interior calaix costella metàlica*  
 Kaxoi barnekaldea saihets metalikoekin  
*Interior caixóns costela metàlica*

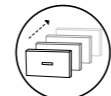

Cajón con cierre amortiguado  
*Drawer fitted with soft closing system*  
 Gaveta com sistema de corrediças com amortecedor  
*Calaixos amb sistema de tancament suau*  
 Motelgailudun itxierazko kajoia  
*Caixón con peche amortecido*

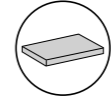

Acabado lacado mate  
*Matte lacquered finish*  
 Cor lacado mate  
 Acabat lacat mat  
 Mate lakatzko bukatua  
 Acabado lacado mate

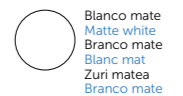

**TRENT\_80 (31.5")**

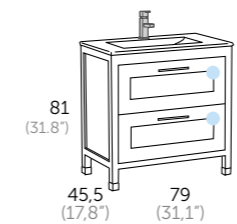

- Acabado Referencia  
 ○ Blanco mate 195 01 080  
 ● Gris mate 195 03 080

ESPEJO

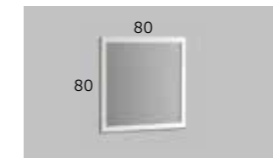

**TRENTE**

- Acabado Referencia  
 Blanco mate 295 01 080  
 Gris mate 295 03 080

ENCIMERAS / *countertops / lavatorios / lavabos / gainekoak / encimeras*

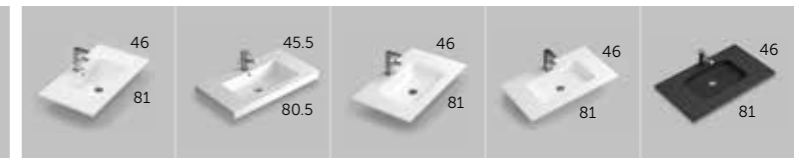

- |                                      |   |                                      |                                       |  |
|--------------------------------------|---|--------------------------------------|---------------------------------------|--|
| <b>ONIX</b><br>Referencia 500 01 080 | <b>TOPACIO</b><br>Referencia 505 01 080 | <b>JADE</b><br>Referencia 504 01 080 | <b>AMBAR</b><br>Referencia 506 01 080 | <b>MASAI</b><br>Referencia 518 02 080<br>Más colores en pág. 308-311 |
|--------------------------------------|---|--------------------------------------|---------------------------------------|--|

**TRENT\_100 (39.4")**

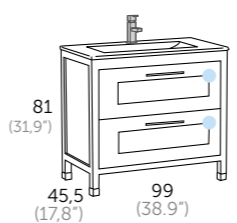

- Acabado Referencia  
 ○ Blanco mate 195 01 100  
 ● Gris mate 195 03 100

ESPEJO

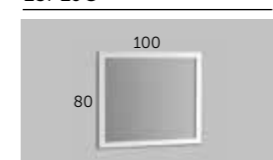

**TRENTE**

- Acabado Referencia  
 Blanco mate 295 01 100  
 Gris mate 295 03 100

ENCIMERAS / *countertops / lavatorios / lavabos / gainekoak / encimeras*



- |                                      |   |                                      |                                       |  |
|--------------------------------------|---|--------------------------------------|---------------------------------------|--|
| <b>ONIX</b><br>Referencia 500 01 100 | <b>TOPACIO</b><br>Referencia 505 01 100 | <b>JADE</b><br>Referencia 504 01 100 | <b>AMBAR</b><br>Referencia 506 01 100 | <b>MASAI</b><br>Referencia 518 02 100 225<br>Más colores en pág. 308-311 |
|--------------------------------------|---|--------------------------------------|---------------------------------------|--|

**APLIQUES / *spotlights / apliques / aplics / ezarkinak / apliques***



Válvula universal  
**CLIC CLAC**  
 Referencia 51601



- |  |   |  |  |   |
|--|---|--|--|---|
| <b>ESTHER LED</b><br>Referencia 400 00 121<br>luz fría<br>400 00 221<br>luz cálida | <b>SOFIA LED</b><br>Referencia 400 00 141<br>luz fría<br>400 00 241<br>luz cálida | <b>AINHOA LED</b><br>Referencia 400 00 151<br>luz fría | <b>NIKITA LED</b><br>Referencia 400 01 171<br>luz fría | <b>NAYRA LED</b><br>Referencia 400 00 181<br>luz fría |
|--|---|--|--|---|



Sigma  
Omega  
Landes  
Landes modular  
Strip  
Cairo  
Dúo  
Ikaro  
Denim  
Lip  
Wave  
Sky  
Trent  
**Escorpio\_**  
Tauro  
Wood  
Mar  
Hole  
Aries  
Galsaky  
Small  
Homy  
Comet  
Tivoli  
Moon  
Dominó



# Escorpio

\_60/70/80/100



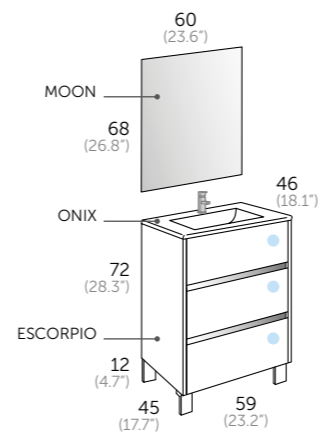



Composición **ESCORPIO 60 (23.6")**

- 1 123 03 060 ESCORPIO 60
- 1 500 01 060 ONIX
- 1 200 00 060 MOON



 Interior cajones acabado textil  
*Interior of drawer textile finish*  
 Interiores gaveta em acabamento têxtil  
 Interior caiaix en acabat tèxtil  
 Ehun-bukaerazko barnekalde-dun kajoia  
 Interior do caixón en acabado têxtil





 Cajón con cierre amortiguado  
*Drawer fitted with soft closing system*  
 Gaveta com sistema de correções com amortecedor  
 Calaixos amb sistema de tançament suau  
 Motelgailudun itxierazko kajoia  
 Caixón con peche amortecido

 Frente cajón regulable  
*Adjustable front drawer*  
 Frente da gaveta ajustável  
 Frontal caiaix regulable  
 Neurrirako kajoj aurrekaldea  
 Fronte do caixón axustable

 Acabado lacado brillo  
*High gloss lacquered finish*  
 Cor lacado brilho  
 Acabat lacat brillant  
 Distiradun lakatzko bukatua  
 Acabado lacado brillo

 Guías Hettich  
*Hettich drawer sliding system*  
 Guias Hettich  
 Guies Hettich  
 Hettich gidak  
 Guías Hettich



-  Blanco  
White  
Branco  
Blanc  
Zuria  
Branco
-  Gris  
Grey  
Cinzento  
Gris  
Grisa  
Gris
-  Roble natural  
Natural oak  
Carvalho natural  
Roure natural  
Haritz naturala  
Carballo natural
-  Pino gris  
Grey pine  
Pinho cinzento  
Pi gris  
Pino grisa  
Piñeiro gris
-  Nogal oscuro  
Dark walnut  
Nogueira escuro  
Nogueira fosc  
Imtxaurondo iluna  
Nogueira escura

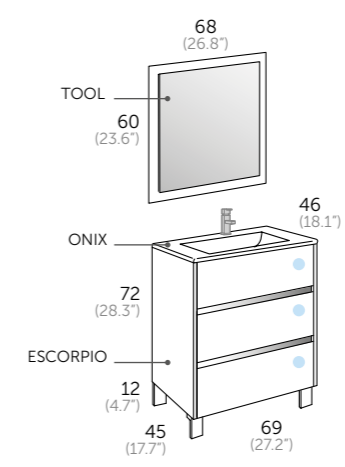

Composición **ESCORPIO 70 (27.5")**

- 1 123 01 070 ESCORPIO 70
- 1 500 01 070 ONIX
- 1 207 01 060 TOOL





- Bianco  
White  
Blanco  
Blanc  
Zuria  
Branco
- Gris  
Grey  
Cinzento  
Gris  
Grisa  
Gris
- Roble natural  
Natural oak  
Carvalho natural  
Roure natural  
Haritz naturala  
Carballo natural
- Pino gris  
Grey pine  
Pinho cinzento  
Pi gris  
Pinu gris  
Piñeiro gris
- Nogal oscuro  
Dark walnut  
Nogueira escuro  
Nogueira fosc  
Inbaxurondo iluna  
Nogueira escura

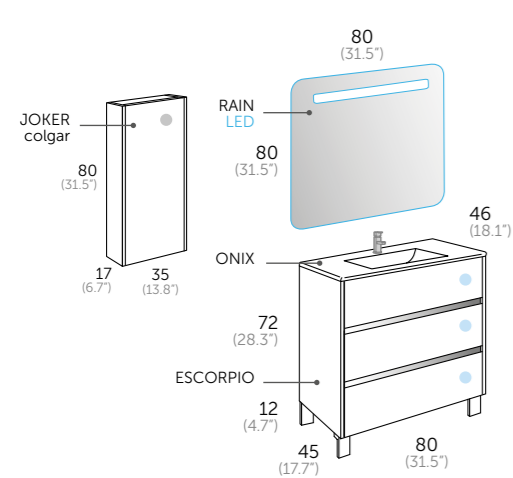

Composición **ESCORPIO 80 (31.5")**

- 1 123 37 080 ESCORPIO 80
- 1 500 01 080 ONIX
- 1 269 00 080 RAIN LED

Auxiliares

- 1 137 37 435 JOKER colgar

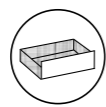

Interior cajones acabado textil  
Interior of drawer textile finish  
Interiores gaveta em acabamento têxtil  
Interior calaix en acabat tèxtil  
Ehun-bukerazko barnekaldean kajoia  
Interior do caixón en acabado têxtil

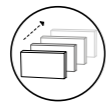

Cajón con cierre amortiguado  
Drawer fitted with soft closing system  
Gaveta com sistema de corredeiras com amortecedor  
Calaixos amb sistema de tancament suau  
Motelgailudun itxierazko kajoia  
Caixón con peche amortecido

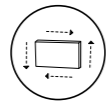

Frente cajón regulable  
Adjustable front drawer  
Frente da gaveta ajustável  
Frontal calaix regulable  
Neurrirako kajoï aurrekaldea  
Frente do caixón axustable



Puerta con cierre amortiguado  
Door with soft closing system  
Porta com amortecedor  
Porta amb sistema de tancament suau  
Motelgailudun itxierazko atea  
Porta con peche amortecido

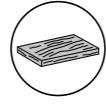

Acabado melamina con textura  
Textured melamine finish  
Cor melamina com textura  
Acabat melamina amb textura  
Testuradun melamina bukatua  
Acabado melamina con textura



Guías Hettich  
Hettich drawer sliding system  
Guías Hettich  
Guías Hettich  
Hettich gidak  
Guías Hettich

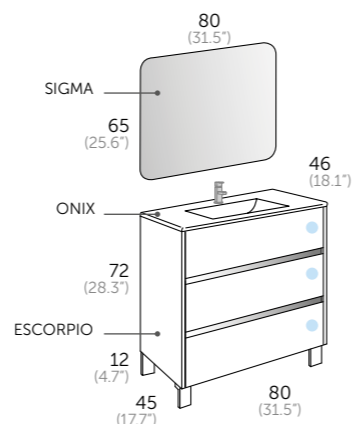

Composición **ESCORPIO 80 (31.5")**

- 1 123 39 080 ESCORPIO 80
- 1 500 01 080 ONIX
- 1 290 00 080 SIGMA



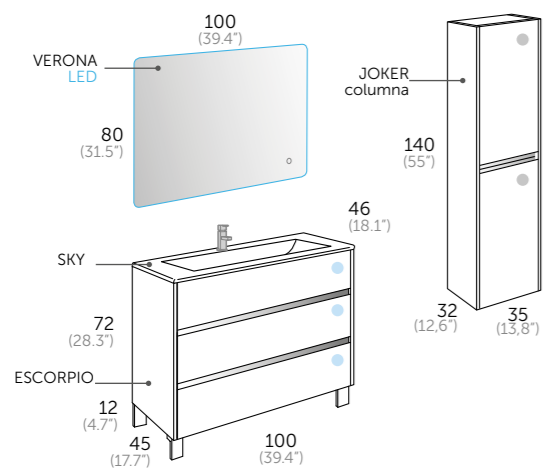

Composición **ESCORPIO 100** (39,4")

- 1 123 24 100 ESCORPIO 100
- 1 517 01 100 SKY
- 1 246 00 100 VERONA LED

Auxiliares

- 1 137 24 335 JOKER columna

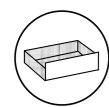

Interior cajones acabado textil  
*Interior of drawer textile finish*  
 Interiores gaveta em acabamento têxtil  
*Interior calaix en acabat tèxtil*  
 Ehun-bukarazko barnekaldedun kajoia  
*Interior do caixón en acabado têxtil*



Sistema antivaho  
*Anti fog system*  
 Sistema anti-vapor  
 Sistema antibal  
 Lurrunaren kontrako sistema  
 Sistema antivaho

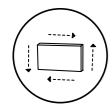

Frente cajón regulable  
*Adjustable front drawer*  
 Frente da gaveta ajustável  
 Frontal calaix regulable  
 Neurrirako kajoï aurrekaldea  
 Fronte do caixón axustable



Sensor de contacto On/ Off  
*Contact sensor On/ Off*  
 Sensor interruptor On/ Off  
 Sensor de contacto On/ Off  
 On/Off kontaktu sentsoera  
 Sensor de contacto On/ Off



Cajón con cierre amortiguado  
*Drawer fitted with soft closing system*  
 Gaveta com sistema de correijas com amortecedor  
 Calaixos amb sistema de tancament suau  
 Motelgailudun itxierazko kajoia  
 Caixón con peche amortecido



Reversible  
*It is reversible*  
 Reversível  
 Reversible  
 Itzulgarria  
 Reversible



Guías Hettich  
*Hettich drawer sliding system*  
 Guias Hettich  
 Guies Hettich  
 Hettich gidak  
 Guias Hettich



Luz ambiental  
*Ambient light*  
 Luz ambiente  
 Llum ambiental  
 Giro-argia  
 Luz ambiental



Acabado melamina con textura  
*Textured melamine finish*  
 Cor melamina com textura  
 Acabat melamina amb textura  
 Testuradun melamina bukatua  
 Acabado melamina con textura

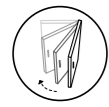

Puerta con cierre amortiguado  
*Door with soft closing system*  
 Porta com amortecedor  
 Porta amb sistema de tancament suau  
 Motelgailudun itxierazko atea  
 Porta con peche amortecido

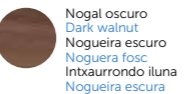

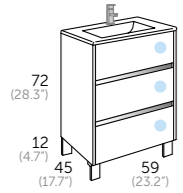

- Acabado Referencia
- Blanco 123 01 060
  - Gris 123 03 060
  - Roble natural 123 24 060
  - Pino gris 123 37 060
  - Nogal oscuro 123 39 060

ENCIMERAS / *countertops / lavatorios / lavabos / gaineoak / encimeras*



- |   |  |  |  |   |
|---|--|--|--|---|
| <b>ONIX</b> cerámica<br>Referencia 500 01 060 | <b>TOPACIO</b> resina<br>Referencia 505 01 060 | <b>JADE</b> masa blanca<br>Referencia 504 01 060 | <b>MASAI</b><br>Referencia 518 02 060<br>Más colores en pág. 308-311 | <b>CRISTAL</b><br>Acabado Referencia<br>Metalizado Negro 502 11 060<br>502 02 060 |
|---|--|--|--|---|

ESPEJOS / *mirrors / espelhos / miralls / ispiluak / espellos*

CAMERINO

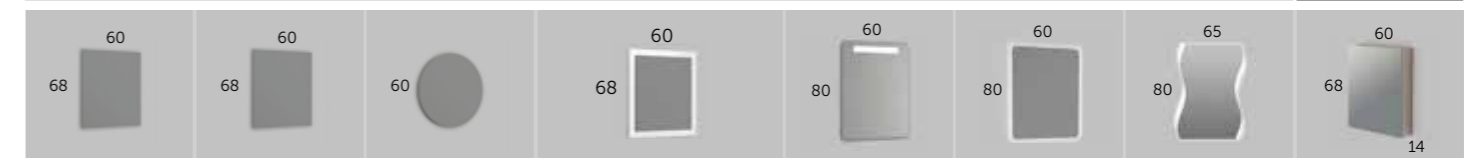

- |                                      |                                       |   |   |  |  |  |                                       |
|--------------------------------------|---------------------------------------|---|---|--|--|--|---------------------------------------|
| <b>MOON</b><br>Referencia 200 00 060 | <b>CLOUD</b><br>Referencia 205 00 060 | <b>REDONDO</b><br>Referencia 244 00 060 | <b>TOOL</b><br>Acabado Referencia<br>○ Blanco 207 01 060<br>● Gris 207 03 060<br>● Roble natural 207 24 060 | <b>RAIN LED</b><br>Referencia 269 00 060 | <b>VERONA LED</b><br>Referencia 246 00 060 | <b>MÓDENA LED</b><br>Referencia 264 00 080 | <b>FLASH</b><br>Referencia 340 11 060 |
|--------------------------------------|---------------------------------------|---|---|--|--|--|---------------------------------------|

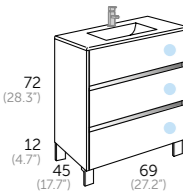

- Acabado Referencia
- Blanco 123 01 070
  - Gris 123 03 070
  - Roble natural 123 24 070
  - Pino gris 123 37 070
  - Nogal oscuro 123 39 070

ENCIMERAS / *countertops / lavatorios / lavabos / gaineoak / encimeras*

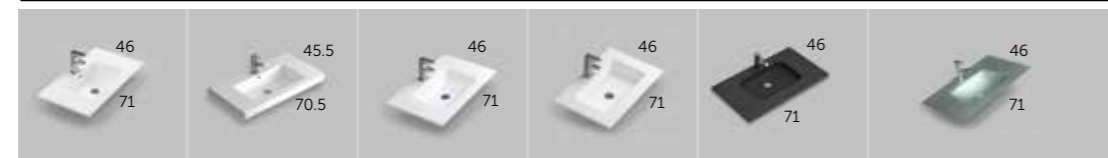

- |   |   |                                      |  |  |   |
|---|---|--------------------------------------|--|--|---|
| <b>ONIX</b> cerámica<br>Referencia 500 01 070 | <b>TOPACIO</b><br>Referencia 505 01 070 | <b>JADE</b><br>Referencia 504 01 070 | <b>AMBAR</b> mate<br>Referencia 506 01 070 | <b>MASAI</b><br>Referencia 518 02 070<br>Más colores en pág. 308-311 | <b>CRISTAL</b><br>Acabado Referencia<br>Metalizado Negro 502 11 070<br>502 02 070 |
|---|---|--------------------------------------|--|--|---|

ESPEJOS / *mirrors / espelhos / miralls / ispiluak / espellos*

CAMERINO

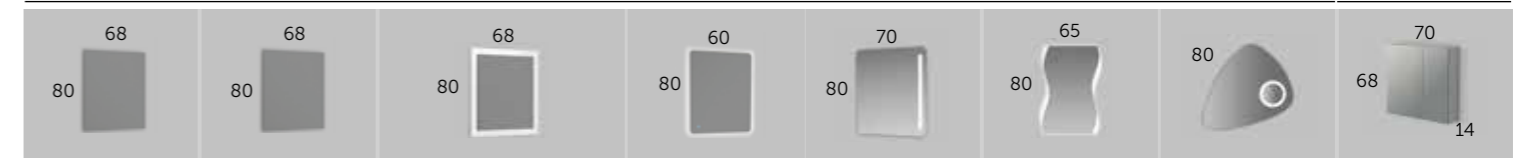

- |                                      |                                       |   |  |   |  |   |                                       |
|--------------------------------------|---------------------------------------|---|--|---|--|---|---------------------------------------|
| <b>MOON</b><br>Referencia 200 00 080 | <b>CLOUD</b><br>Referencia 205 00 080 | <b>TOOL</b><br>Acabado Referencia<br>○ Blanco 207 01 080<br>● Gris 207 03 080<br>● Roble natural 207 24 080 | <b>VERONA LED</b><br>Referencia 246 00 060 | <b>MILAN LED</b><br>Referencia 268 00 080 | <b>MÓDENA LED</b><br>Referencia 264 00 080 | <b>STONE LED</b><br>Referencia 261 00 080 | <b>FLASH</b><br>Referencia 340 11 070 |
|--------------------------------------|---------------------------------------|---|--|---|--|---|---------------------------------------|

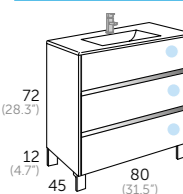

- Acabado Referencia
- Blanco 123 01 080
  - Gris 123 03 080
  - Roble natural 123 24 080
  - Pino gris 123 37 080
  - Nogal oscuro 123 39 080

ENCIMERAS / *countertops / lavatorios / lavabos / gaineoak / encimeras*

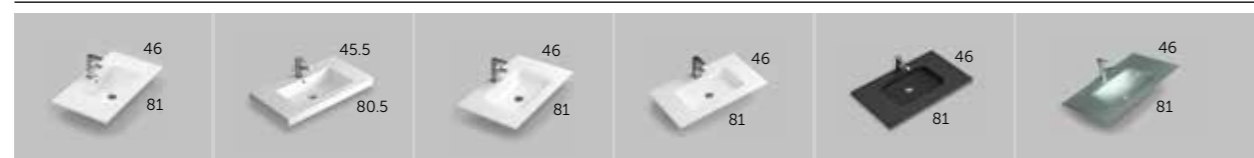

- |   |  |  |  |  |   |
|---|--|--|--|--|---|
| <b>ONIX</b> cerámica<br>Referencia 500 01 080 | <b>TOPACIO</b> resina<br>Referencia 505 01 080 | <b>JADE</b> masa blanca<br>Referencia 504 01 080 | <b>AMBAR</b> mate<br>Referencia 506 01 080 | <b>MASAI</b><br>Referencia 518 02 080<br>Más colores en pág. 308-311 | <b>CRISTAL</b><br>Acabado Referencia<br>Metalizado Negro 502 11 080<br>502 02 080 |
|---|--|--|--|--|---|

ESPEJOS / *mirrors / espelhos / miralls / ispiluak / espellos*

CAMERINO



- |                                      |                                       |                                       |   |  |  |  |   |                                       |
|--------------------------------------|---------------------------------------|---------------------------------------|---|--|--|--|---|---------------------------------------|
| <b>MOON</b><br>Referencia 200 00 080 | <b>CLOUD</b><br>Referencia 205 00 080 | <b>SIGMA</b><br>Referencia 290 00 080 | <b>TOOL</b><br>Referencia<br>○ 207 01 080<br>● 207 03 080<br>● 207 24 080 | <b>RAIN LED</b><br>Referencia 269 00 080 | <b>VERONA LED</b><br>Referencia 246 00 100 | <b>HOLMES LED</b><br>Referencia 263 00 080 | <b>SPOTY LED</b><br>Referencia 267 00 080 | <b>FLASH</b><br>Referencia 340 11 080 |
|--------------------------------------|---------------------------------------|---------------------------------------|---|--|--|--|---|---------------------------------------|

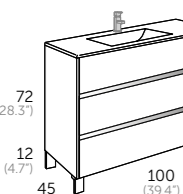

- Acabado Referencia
- Blanco 123 01 100
  - Gris 123 03 100
  - Roble natural 123 24 100
  - Pino gris 123 37 100
  - Nogal oscuro 123 39 100

ENCIMERAS / *countertops / lavatorios / lavabos / gaineoak / encimeras*



- |   |                                     |  |  |  |  |
|---|-------------------------------------|--|--|--|--|
| <b>ONIX</b> cerámica<br>Referencia 500 01 100 | <b>SKY</b><br>Referencia 517 01 100 | <b>TOPACIO</b> resina<br>Referencia 505 01 100 | <b>JADE</b> masa blanca<br>Referencia 504 01 100 | <b>AMBAR</b> mate<br>Referencia 506 01 100 | <b>MASAI</b><br>Referencia 518 02 100<br>Más colores en pág. 308-311 |
|---|-------------------------------------|--|--|--|--|

ESPEJOS / *mirrors / espelhos / miralls / ispiluak / espellos*

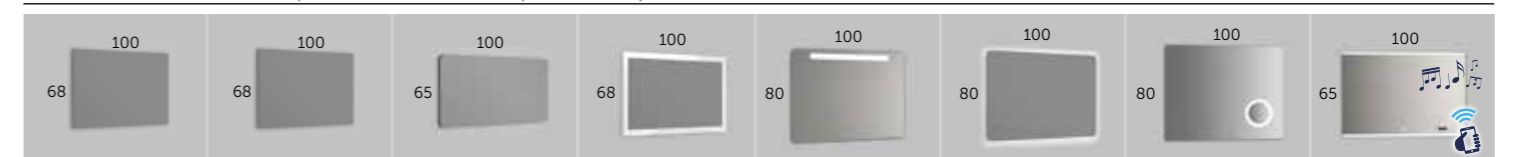

- |                                      |                                       |                                       |   |  |  |  |   |
|--------------------------------------|---------------------------------------|---------------------------------------|---|--|--|--|---|
| <b>MOON</b><br>Referencia 200 00 100 | <b>CLOUD</b><br>Referencia 205 00 100 | <b>SIGMA</b><br>Referencia 290 00 100 | <b>TOOL</b><br>Referencia<br>○ 207 01 100<br>● 207 03 100<br>● 207 24 100 | <b>RAIN LED</b><br>Referencia 269 00 100 | <b>VERONA LED</b><br>Referencia 246 00 100 | <b>HOLMES LED</b><br>Referencia 263 00 100 | <b>SPOTY LED</b><br>Referencia 267 00 100 |
|--------------------------------------|---------------------------------------|---------------------------------------|---|--|--|--|---|

AUXILIARES / *auxiliary units / auxiliares / auxiliars / osagarriak / auxiliares*

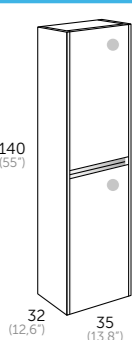

- JOKER** columna
- Acabado Referencia
- Blanco 137 01 335
  - Gris 137 03 335
  - Roble natural 137 24 335
  - Pino gris 137 37 335
  - Nogal oscuro 137 39 335

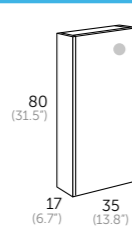

- JOKER** colgar
- Acabado Referencia
- Blanco 137 01 435
  - Gris 137 03 435
  - Roble natural 137 24 435
  - Pino gris 137 37 435
  - Nogal oscuro 137 39 435

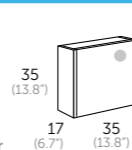

- JOKER** auxiliar
- Acabado Referencia
- Blanco 137 01 445
  - Gris 137 03 445
  - Roble natural 137 24 445
  - Pino gris 137 37 445
  - Nogal oscuro 137 39 445



- Válvula universal CLIC CLAC**  
Referencia 51601

APLIQUES / *spotlights / apliques / aplics / ezarkinak / apliques*



- |   |  |  |   |  |  |   |
|---|--|--|---|--|--|---|
| <b>EVA LED</b><br>Referencia 400 00 011 | <b>NEREA mate LED</b><br>Referencia 400 14 161<br>luz fría | <b>ESTHER LED</b><br>Referencia 400 00 121<br>luz fría<br>400 00 221<br>luz cálida | <b>SOFIA LED</b><br>Referencia 400 00 141<br>luz fría<br>400 00 241<br>luz cálida | <b>AINHOA LED</b><br>Referencia 400 00 151<br>luz fría | <b>NIKITA LED</b><br>Referencia 400 01 171<br>luz fría | <b>NAYRA LED</b><br>Referencia 400 00 181<br>luz fría |
|---|--|--|---|--|--|---|

# Tauro

\_70/80/100

Sigma  
Omega  
Landes  
Landes modular  
Strip  
Cairo  
Dúo  
Ikaro  
Denim  
Lip  
Wave  
Sky  
Trent  
Escorpio  
**Tauro\_**  
Wood  
Mar  
Hole  
Aries  
Galsaky  
Small  
Homy  
Comet  
Tívoli  
Moon  
Dominó



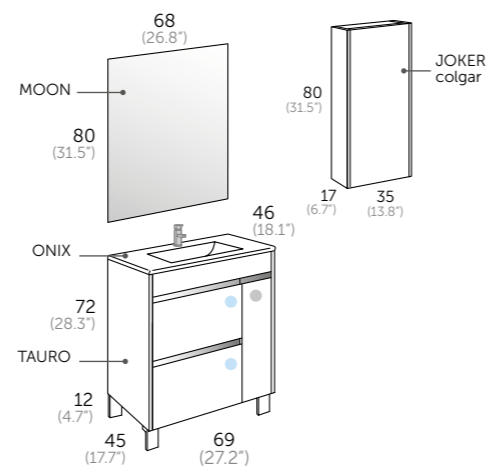

Composición **TAURO 70 (27.5")**

- 1 122 03 070 TAURO 70
- 1 500 01 070 ONIX
- 1 200 00 080 MOON

Auxiliares

- 1 137 03 435 JOKER colgar

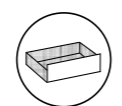

Interior cajones acabado textil  
*Interior of drawer textile finish*  
 Interiores gaveta em acabamento têxtil  
*Interior caiaix en acabat tèxtil*  
 Ehun-bukarazko barnekaldeak kajoia  
*Interior do caixón en acabado textil*



Cajón con cierre amortiguado  
*Drawer fitted with soft closing system*  
 Gaveta com sistema de corredeiras com amortecedor  
*Caiaixos amb sistema de tancament suau*  
 Motelgailudun itxierazko kajoia  
*Caixón con peche amortecido*

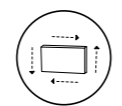

Frente cajón regulable  
*Adjustable front drawer*  
 Frente da gaveta ajustável  
*Frontal caiaix regulable*  
 Neurrirako kajoj aurrekaldea  
*Fronte do caixón axustable*



Puerta con cierre amortiguado  
*Door with soft closing system*  
 Porta com amortecedor  
*Porta amb sistema de tancament suau*  
 Motelgailudun itxierazko atea  
*Porta con peche amortecido*

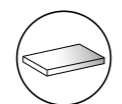

Acabado lacado brillo  
*High gloss lacquered finish*  
 Cor lacado brilho  
*Acabat lacat brillant*  
 Distiradun lakatzeko bukatua  
*Acabado lacado brillo*



Guías Hettich  
*Hettich drawer sliding system*  
 Guías Hettich  
*Guias Hettich*  
 Hettich gidak  
*Guias Hettich*

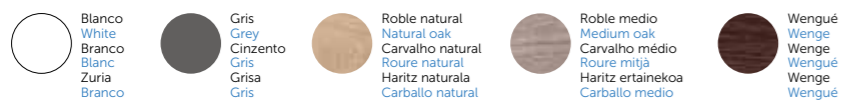

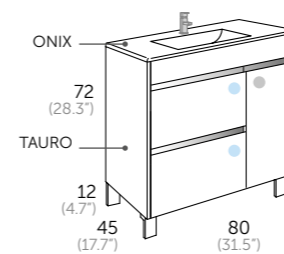

Composición **TAURO 80 (31.5")**

- 1 122 20 080 TAURO 80
- 1 500 01 080 ONIX



- Blanco (White, Branco, Blanc, Zuria, Branco)
- Gris (Grey, Cinzento, Gris, Grisa, Gris)
- Roble natural (Natural oak, Carvalho natural, Roure natural, Haritz naturala, Carballo natural)
- Roble medio (Medium oak, Carvalho medio, Roure mitjà, Haritz ertainekoa, Carballo medio)
- Wengué (Wenge, Wenge, Wengué)

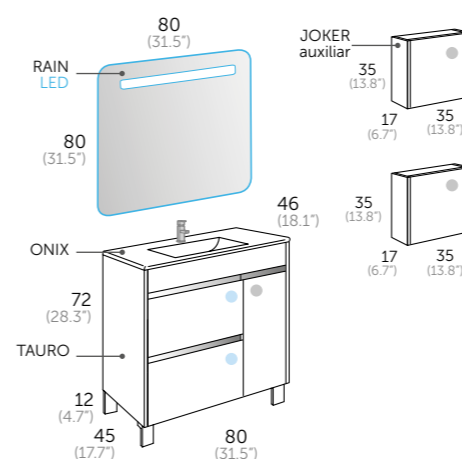

Composición **TAURO 80 (31.5")**

- 1 122 21 080 TAURO 80
- 1 500 01 080 ONIX
- 1 269 00 080 RAIN LED

Auxiliares

- 2 137 21 445 JOKER auxiliar

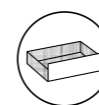

Interior cajones acabado textil  
Interior of drawer textile finish  
Interiores gaveta em acabamento têxtil  
Interior calaix en acabat tèxtil  
Ehun-bukaerazko barnekaldeak kaxioia  
Interior do caixón en acabado textil

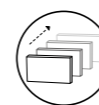

Cajón con cierre amortiguado  
Drawer fitted with soft closing system  
Gaveta com sistema de corredeiras com amortecedor  
Calaixos amb sistema de tancament suau  
Motelgailudun itxierazko kaxioia  
Caixón con peche amortecido

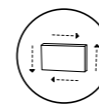

Frente cajón regulable  
Adjustable front drawer  
Frente da gaveta ajustável  
Frontal calaix regulable  
Neurrirako kaxoi aurrekaldea  
Fronte do caixón axustable



Puerta con cierre amortiguado  
Door with soft closing system  
Porta com amortecedor  
Porta amb sistema de tancament suau  
Motelgailudun itxierazko atea  
Porta con peche amortecido

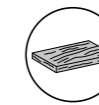

Acabado melamina con textura  
Textured melamine finish  
Cor melamina com textura  
Acabat melamina amb textura  
Testuradun melamina bukatua  
Acabado melamina con textura



Guías Hettich  
Hettich drawer sliding system  
Guías Hettich  
Guias Hettich  
Hettich gidak  
Guías Hettich

Composición **TAURO 100** (39.4")

- 1 122 24 100 TAURO 100
- 1 517 01 100 SKY
- 1 246 00 100 VERONA LED

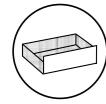

Interior cajones acabado textil  
*Interior of drawer textile finish*  
 Interiores gaveta em acabamento têxtil  
*Interior calaix en acabat tèxtil*  
 Ehun-bukaerazko barnekaldedun kajoia  
*Interior do caixón en acabado têxtil*

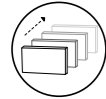

Cajón con cierre amortiguado  
*Drawer fitted with soft closing system*  
 Gaveta com sistema de corredeiras com amortecedor  
*Calaixos amb sistema de tancament suau*  
 Motelgailudun itxierazko kajoia  
*Caixón con peche amortecido*

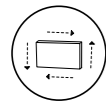

Frente cajón regulable  
*Adjustable front drawer*  
 Fronte da gaveta ajustável  
*Frontal calaix regulable*  
 Neurrirako kajoí aurrekaldea  
*Fronte do caixón axustable*

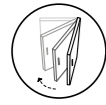

Puerta con cierre amortiguado  
*Door with soft closing system*  
 Porta com amortecedor  
*Porta amb sistema de tancament suau*  
 Motelgailudun itxierazko atea  
*Porta con peche amortecido*

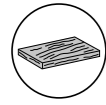

Acabado melamina con textura  
*Textured melamine finish*  
 Cor melamina com textura  
*Acabat melamina amb textura*  
 Testuradun melamina bukatua  
*Acabado melamina con textura*



Guías Hettich  
*Hettich drawer sliding system*  
 Guias Hettich  
*Guias Hettich*  
 Hettich gidak  
*Guias Hettich*

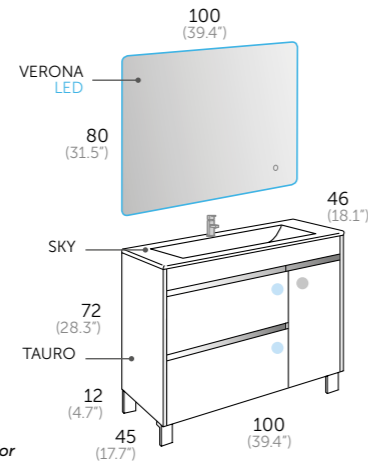

Sistema antivaho  
*Anti fog system*  
 Sistema anti-vapor  
*Sistema antibaf*  
 Lurrunaren kontrako sistema  
*Sistema antivaho*



Sensor de contacto On/ Off  
*Contact sensor On/ Off*  
 Sensor interruptor On/ Off  
*Sensor de contacte On/ Off*  
 On/Off kontaktu sensorea  
*Sensor de contacto On/ Off*



Reversible  
*It is reversible*  
 Reversível  
*Reversible*  
 Itzulgarria  
*Reversible*



Luz ambiental  
*Ambient light*  
 Luz ambiente  
*Llum ambiental*  
 Giro-argia  
*Luz ambiental*

- |  |                           |  |                          |  |  |  |   |  |                           |
|--|---------------------------|--|--------------------------|--|--|--|---|--|---------------------------|
|  | Blanco<br>White<br>Branco |  | Gris<br>Grey<br>Cinzento |  | Roble natural<br>Natural oak<br>Carvalho natural |  | Roble medio<br>Medium oak<br>Carvalho médio |  | Wengué<br>Wenge<br>Wengué |
|  | Zuria<br>Branco           |  | Grisa<br>Gris            |  | Haritz naturala<br>Carballo natural              |  | Haritz ertainekoa<br>Carballo medio         |  | Wenge<br>Wengué           |





## TAURO\_70 (27.5")

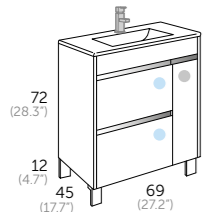

- Acabado Referencia
- Blanco 122 01 070
  - Gris 122 03 070
  - Roble natural 122 24 070
  - Roble medio 122 21 070
  - Wengué 122 20 070

### ENCIMERAS / countertops / lavatorios / lavabos / gainekoak / encimeras



- | Modelo  | Material                 | Referencia                                   |
|---------|--------------------------|--|
| ONIX    | cerámica                 | 500 01 070                                   |
| TOPACIO |                          | 505 01 070                                   |
| JADE    | masa blanca              | 504 01 070                                   |
| AMBAR   | mate                     | 506 01 070                                   |
| MASAI   |                          | 518 02 070                                   |
| CRISTAL | Acabado Metalizado Negro | Referencia 502 11 070, Referencia 502 02 070 |
- Más colores en pág. 308-311

### ESPEJOS / mirrors / espelhos / miralls / ispiluak / espellos

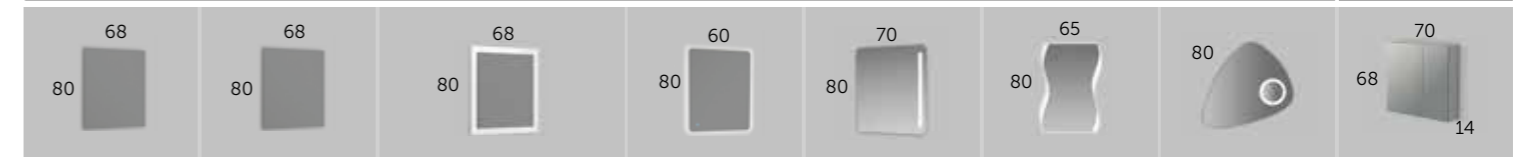

- | Modelo     | Referencia   |
|------------|--|
| MOON       | 200 00 080   |
| CLOUD      | 205 00 080   |
| TOOL       | Referencia 207 01 080, Referencia 207 03 080, Referencia 207 24 080, Referencia 207 21 080 |
| VERONA LED | 246 00 060   |
| MILAN LED  | 268 00 080   |
| MÓDENA LED | 264 00 080   |
| STONE LED  | 261 00 080   |
| FLASH      | 340 11 070   |

## TAURO\_80 (31.5")

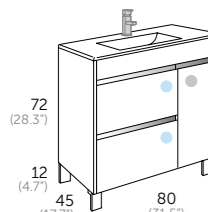

- Acabado Referencia
- Blanco 122 01 080
  - Gris 122 03 080
  - Roble natural 122 24 080
  - Roble medio 122 21 080
  - Wengué 122 20 080

### ENCIMERAS / countertops / lavatorios / lavabos / gainekoak / encimeras



- | Modelo  | Material                 | Referencia   |
|---------|--------------------------|--|
| ONIX    | cerámica                 | 500 01 080   |
| TOPACIO | resina                   | 505 01 080   |
| JADE    | masa blanca              | 504 01 080   |
| AMBAR   | mate                     | 506 01 080   |
| MASAI   |                          | Referencia 518 02 080, Más colores en pág. 308-311 |
| CRISTAL | Acabado Metalizado Negro | Referencia 502 11 080, Referencia 502 02 080       |

### ESPEJOS / mirrors / espelhos / miralls / ispiluak / espellos



- | Modelo     | Referencia   |
|------------|--|
| MOON       | 200 00 080   |
| CLOUD      | 205 00 080   |
| SIGMA      | 290 00 080   |
| TOOL       | Referencia 207 01 080, Referencia 207 03 080, Referencia 207 24 080, Referencia 207 21 080 |
| RAIN LED   | 269 00 080   |
| VERONA LED | 246 00 100   |
| HOLMES LED | 263 00 080   |
| SPOTY LED  | 267 00 080   |
| FLASH      | 340 11 080   |

## TAURO\_100 (39.4")

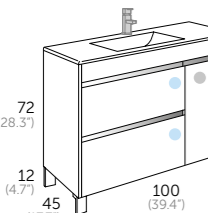

- Acabado Referencia
- Blanco 122 01 100
  - Gris 122 03 100
  - Roble natural 122 24 100
  - Roble medio 122 21 100
  - Wengué 122 20 100

### ENCIMERAS / countertops / lavatorios / lavabos / gainekoak / encimeras



- | Modelo  | Material    | Referencia   |
|---------|-------------|--|
| ONIX    | cerámica    | 500 01 100   |
| SKY     |             | 517 01 100   |
| TOPACIO | resina      | 505 01 100   |
| JADE    | masa blanca | 504 01 100   |
| AMBAR   | mate        | 506 01 100   |
| MASAI   |             | Referencia 518 02 100, Más colores en pág. 308-311 |

### ESPEJOS / mirrors / espelhos / miralls / ispiluak / espellos

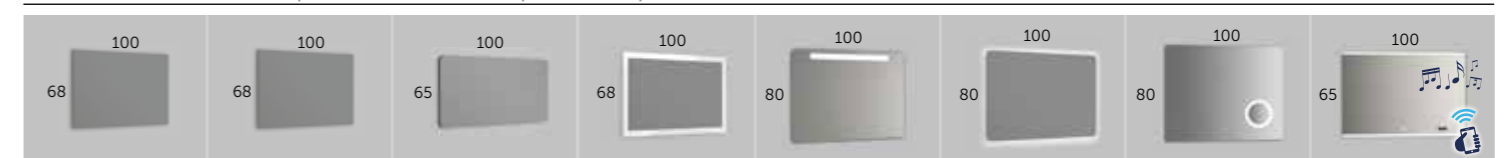

- | Modelo     | Referencia   |
|------------|--|
| MOON       | 200 00 100   |
| CLOUD      | 205 00 100   |
| SIGMA      | 290 00 100   |
| TOOL       | Referencia 207 01 100, Referencia 207 03 100, Referencia 207 24 100, Referencia 207 21 100 |
| RAIN LED   | 269 00 100   |
| VERONA LED | 246 00 100   |
| HOLMES LED | 263 00 100   |
| SPOTY LED  | 267 00 100   |

## AUXILIARES / auxiliary units / auxiliares / auxiliars / osagarriak / auxiliares

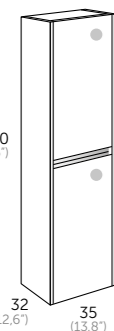

- JOKER columnna**
- Acabado Referencia
- Blanco 137 01 335
  - Gris 137 03 335
  - Roble natural 137 24 335
  - Roble medio 137 21 335
  - Wengué 137 20 335

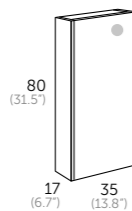

- JOKER colgar**
- Acabado Referencia
- Blanco 137 01 435
  - Gris 137 03 435
  - Roble natural 137 24 435
  - Roble medio 137 21 435
  - Wengué 137 20 435

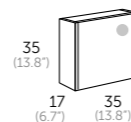

- JOKER auxiliar**
- Acabado Referencia
- Blanco 137 01 445
  - Gris 137 03 445
  - Roble natural 137 24 445
  - Roble medio 137 21 445
  - Wengué 137 20 445



Válvula universal CLIC CLAC  
Referencia 51601

## APLIQUES / spotlights / apliques / aplics / ezarkinak / apliques

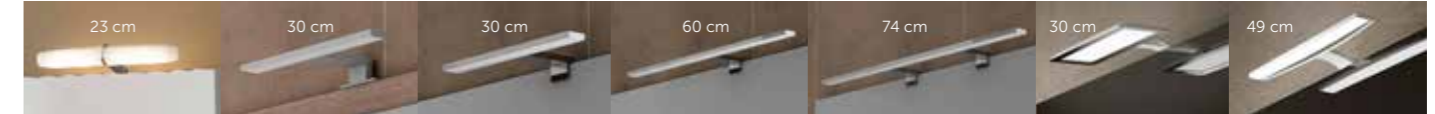

- | Modelo         | Referencia   |
|----------------|--|
| EVA LED        | 400 00 011   |
| NEREA mate LED | Referencia 400 14 161, luz fría                                    |
| ESTHER LED     | Referencia 400 00 121, luz fría, Referencia 400 00 221, luz cálida |
| SOFIA LED      | Referencia 400 00 141, luz fría, Referencia 400 00 241, luz cálida |
| AINHOA LED     | Referencia 400 00 151, luz fría                                    |
| NIKITA LED     | Referencia 400 01 171, luz fría                                    |
| NAYRA LED      | Referencia 400 00 181, luz fría                                    |

Sigma  
Omega  
Landes  
Landes modular  
Strip  
Cairo  
Dúo  
Ikaro  
Denim  
Lip  
Wave  
Sky  
Trent  
Escorpio  
Tauro  
**Wood\_**  
Mar  
Hole  
Aries  
Galsaky  
Small  
Homy  
Comet  
Tívoli  
Moon  
Dominó

\_80/100

# Wood



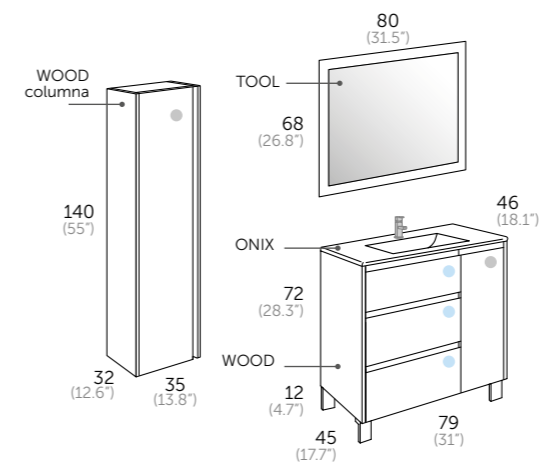

Composición **WOOD 80 (31.5")**

- 1 134 40 080 WOOD 80
- 1 500 01 080 ONIX
- 1 207 24 080 TOOL

Auxiliares

- 1 134 40 335 WOOD columna

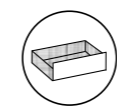

Interior cajones acabado textil  
*Interior of drawer textile finish*  
 Interiores gaveta em acabamento têxtil  
*Interior calaix en acabat tèxtil*  
 Ehun-bukaerazko barnekaldedun kajoia  
*Interior do caixón en acabado têxtil*

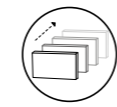

Cajón con cierre amortiguado  
*Drawer fitted with soft closing system*  
 Gaveta com sistema de correções com amortecedor  
*Caixaix amb sistema de tancament suau*  
 Motelgailudun itxierazko kajoia  
*Caixón con peche amortecido*

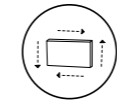

Frente cajón regulable  
*Adjustable front drawer*  
 Fronte da gaveta ajustável  
*Frontal calaix regulable*  
 Neurrirako kajoï aurrekaldea  
*Fronte do caixón axustable*



Puerta con cierre amortiguado  
*Door with soft closing system*  
 Porta com amortecedor  
 Porta amb sistema de tancament suau  
 Motelgailudun itxierazko atea  
*Porta con peche amortecido*



Guías Hettich  
*Hettich drawer sliding system*  
 Guias Hettich  
 Guias Hettich  
 Hettich gidak  
 Guias Hettich

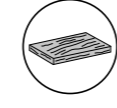

Acabado melamina con textura  
*Textured melamine finish*  
 Cor melamina com textura  
 Acabat melamina amb textura  
 Testuradun melanina bukatua  
 Acabado melanina con textura



Blanco mate / Roble natural  
 Matte White / Natural oak  
 Branco mate / Carvalho natural  
 Blanc mat / Roure natural  
 Zuri matea / Haritz naturala  
 Branco mate / Carballo natural



Blanco mate / Vintage  
 Matte White / Vintage  
 Branco mate / Vintage  
 Blanc mat / Vintage  
 Zuri matea / Vintage  
 Branco mate / Vintage



Blanco mate / Pino gris  
 Matte White / Grey pine  
 Branco mate / Pinho cinzento  
 Blanc mat / Pi gris  
 Zuri matea / Pinu gris  
 Branco mate / Piñeiro gris

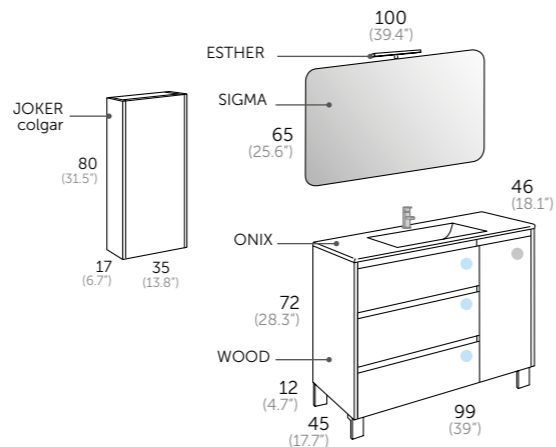

Composición **WOOD 100** (39.4")

- 1 134 41 100 WOOD 100
- 1 500 01 100 ONIX
- 1 290 00 100 SIGMA
- 1 400 00 121 ESTHER

Auxiliares

- 1 137 37 435 JOKER colgar

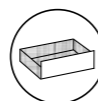

Interior cajones acabado textil  
*Interior of drawer textile finish*  
 Interiores gaveta em acabamento têxtil  
 Interior calaix en acabat tèxtil  
 Ehun-bukaerazko barnekaldedun kajoia  
 Interior do caixón en acabado têxtil

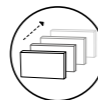

Cajón con cierre amortiguado  
*Drawer fitted with soft closing system*  
 Gaveta com sistema de correções com amortecedor  
 Calaixos amb sistema de tancament suau  
 Motelgailudun itxierazko kajoia  
 Caixón con peche amortecido

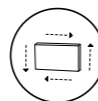

Frente cajón regulable  
*Adjustable front drawer*  
 Frente da gaveta ajustável  
 Frontal calaix regulable  
 Neurrirako kajoï aurrekaldea  
 Fronte do caixón axustable



Guías Hettich  
*Hettich drawer sliding system*  
 Guias Hettich  
 Guias Hettich  
 Hettich gidak  
 Guias Hettich



Puerta con cierre amortiguado  
*Door with soft closing system*  
 Porta com amortecedor  
 Porta amb sistema de tancament suau  
 Motelgailudun itxierazko atea  
 Porta con peche amortecido

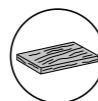

Acabado melamina con textura  
*Textured melamine finish*  
 Cor melamina com textura  
 Acabat melamina amb textura  
 Testuradun melamina bukatua  
 Acabado melamina con textura



Blanco mate / Roble natural  
 Matte White / Natural oak  
 Branco mate / Carvalho natural  
 Blanc mat / Roure naturel  
 Zuri matea / Haritz naturala  
 Branco mate / Carballo natural

Blanco mate / Vintage  
 Matte White / Vintage  
 Branco mate / Vintage  
 Blanc mat / Vintage  
 Zuri matea / Vintage  
 Branco mate / Vintage

Blanco mate / Pino gris  
 Matte White / Grey pine  
 Branco mate / Pinho cinzento  
 Blanc mat / Pi gris  
 Zuri matea / Pinu gris  
 Branco mate / Piñeiro gris



## WOOD\_80 (31.5")

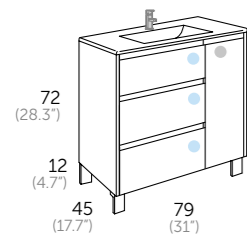

Acabado	Referencia
Blanco mate Roble natural	134 40 080
Blanco mate Vintage	134 43 080
Blanco mate Pino gris	134 41 080

### ENCIMERAS / countertops / lavatorios / lavabos / gaineoak / encimeras



Modelo	Material	Referencia	Notas
ONIX	cerámica	500 01 080	
TOPACIO	resina	505 01 080	
JADE	masa blanca	504 01 080	
AMBAR	mate	506 01 080	
MASAI		Referencia 518 02 080	Más colores en pág. 308-311
CRISTAL	Acabado Metalizado Negro	Referencia 502 11 080	502 02 080

### ESPEJOS / mirrors / espelhos / miralls / ispiluak / espellos



Modelo	Referencia
MOON	Referencia 200 00 080
CLOUD	Referencia 205 00 080
SIGMA	Referencia 290 00 080
TOOL	Referencia 207 24 080
RAIN LED	Referencia 269 00 080
VERONA LED	Referencia 246 00 100
HOLMES LED	Referencia 263 00 080
SPOTY LED	Referencia 267 00 080
FLASH	Referencia 340 11 080

CAMERINO

## WOOD\_100 (39.4")

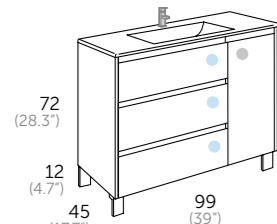

Acabado	Referencia
Blanco mate Roble natural	134 40 100
Blanco mate Vintage	134 43 100
Blanco mate Pino gris	134 41 100

### ENCIMERAS / countertops / lavatorios / lavabos / gaineoak / encimeras



Modelo	Material	Referencia	Notas
ONIX	cerámica	500 01 100	
SKY		Referencia 517 01 100	
TOPACIO	resina	505 01 100	
JADE	masa blanca	504 01 100	
AMBAR	mate	Referencia 506 01 100	
MASAI		Referencia 518 02 100	Más colores en pág. 308-311

### ESPEJOS / mirrors / espelhos / miralls / ispiluak / espellos

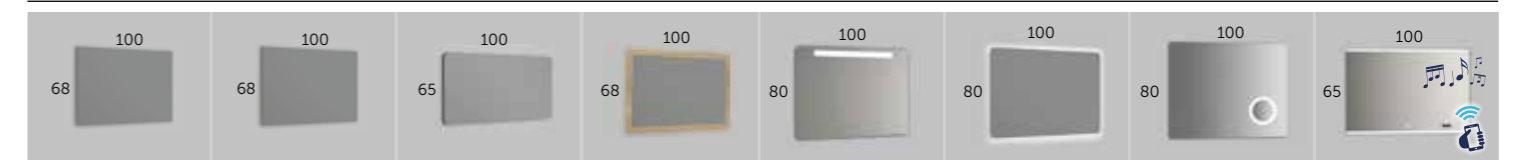

Modelo	Referencia
MOON	Referencia 200 00 100
CLOUD	Referencia 205 00 100
SIGMA	Referencia 290 00 100
TOOL	Referencia 207 24 100
RAIN LED	Referencia 269 00 100
VERONA LED	Referencia 246 00 100
HOLMES LED	Referencia 263 00 100
SPOTY LED	Referencia 267 00 100

## AUXILIARES / auxiliary units / auxiliares / auxiliars / osagarriak / auxiliares

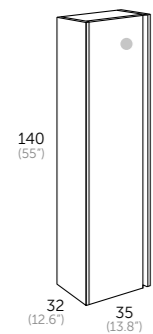

Acabado	Referencia
Blanco mate Roble natural	134 40 335
Blanco mate Vintage	134 43 335
Blanco mate Pino gris	134 41 335

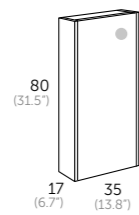

Acabado	Referencia
Roble natural	137 24 435
Pino gris	137 37 435

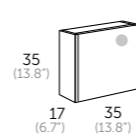

Acabado	Referencia
Roble natural	137 24 445
Pino gris	137 37 445



Válvula universal  
CLIC CLAC  
Referencia 51601

## APLIQUES / spotlights / apliques / aplics / ezarkinak / apliques



Modelo	Referencia	Características
EVA LED	Referencia 400 00 011	
NEREA mate LED	Referencia 400 14 161	luz fría
ESTHER LED	Referencia 400 00 121	luz fría
	Referencia 400 00 221	luz cálida
SOFIA LED	Referencia 400 00 141	luz fría
	Referencia 400 00 241	luz cálida
AINHOA LED	Referencia 400 00 151	luz fría
NIKITA LED	Referencia 400 01 171	luz fría
NAYRA LED	Referencia 400 00 181	luz fría

# Mar<sup>\_90</sup>



Sigma  
Omega  
Landes  
Landes modular  
Strip  
Cairo  
Dúo  
Ikaro  
Denim  
Lip  
Wave  
Sky  
Trent  
Escorpio  
Tauro  
Wood  
**Mar\_**  
Hole  
Aries  
Galsaky  
Small  
Homy  
Comet  
Tívoli  
Moon  
Dominó

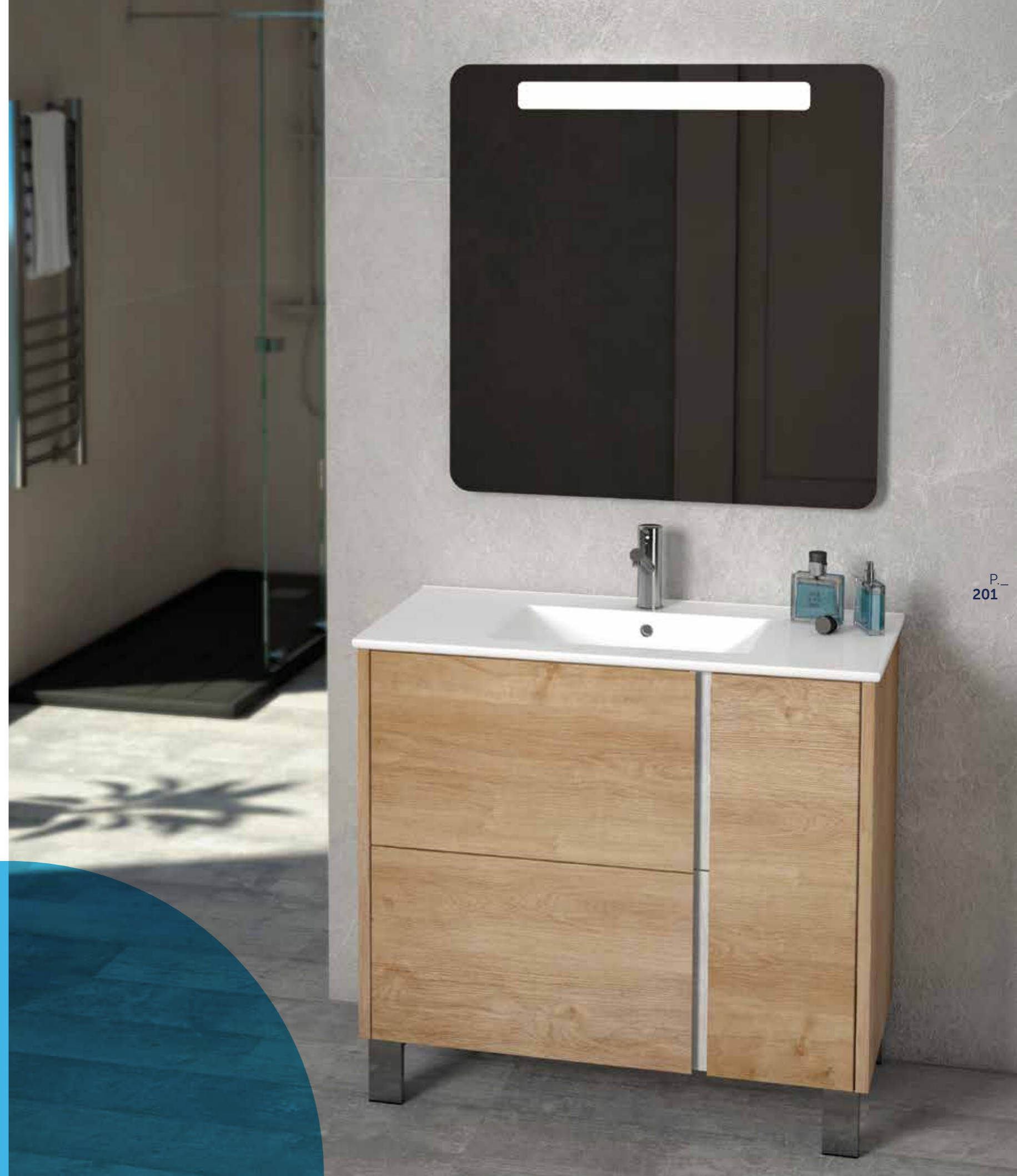

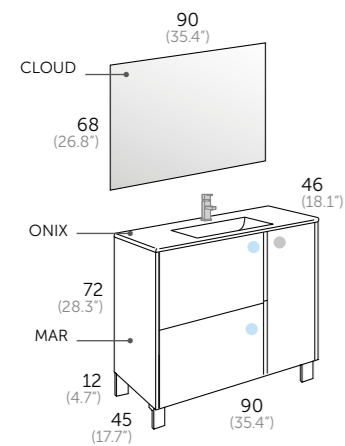

Composición **MAR 90 (35.4")**

- 1 133 01 090 MAR 90
- 1 500 01 090 ONIX
- 1 205 00 090 CLOUD

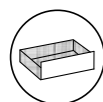

Interior cajones acabado textil  
*Interior of drawer textile finish*  
 Interiores gaveta em acabamento t xtil  
*Interior calaix en acabat textil*  
 Ehun-bukaerazko barnekaldeedun kajoia  
*Interior do caix n en acabado textil*

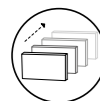

Caj n con cierre amortiguado  
*Drawer fitted with soft closing system*  
 Gaveta com sistema de corredi as com amortecedor  
*Calaixos amb sistema de tancament suau*  
 Motelgailudun itxierazko kajoia  
*Caix n con peche amortecido*

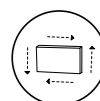

Frente caj n regulable  
*Adjustable front drawer*  
 Frente da gaveta ajust vel  
*Frontal calaix regul ble*  
 Neurrirako kajoj aurrekaldea  
*Fronte do caix n axust ble*



Gu as Hettich  
*Hettich drawer sliding system*  
 Guias Hettich  
*Guias Hettich*  
 Hettich gidak  
*Guias Hettich*

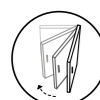

Puerta con cierre amortiguado  
*Door with soft closing system*  
 Porta com amortecedor  
*Porta amb sistema de tancament suau*  
 Motelgailudun itxierazko atea  
*Porta con peche amortecido*

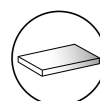

Acabado lacado brillo  
*High gloss lacquered finish*  
 Cor lacado brilho  
*Acabat lacat brillant*  
 Distiradun lakatuzko bukatua  
*Acabado lacado brillo*



Blanco  
 White  
 Branco  
 Blanc  
 Zuri  
 Branco



Roble natural  
 Natural oak  
 Carvalho natural  
 Roure natural  
 Hantz naturala  
 Carballo natural



Nogal oscuro  
 Dark walnut  
 Nogueira escuro  
 Nogueira fosc  
 Inbaurondo iluna  
 Nogueira escura





## MAR\_90 (35.4")

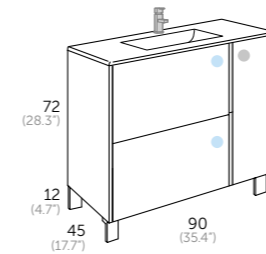

Acabado Referencia  
 ○ Blanco 133 01 090  
 ● Roble natural 133 24 090  
 ● Nogal oscuro 133 39 090

### ENCIMERAS

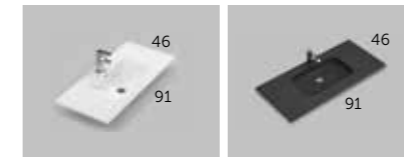

**ONIX** cerámica  
 Referencia 500 01 090

**MASAI**  
 Referencia 518 02 090

Más colores en pág. 308-311



### ESPEJOS / mirrors / espelhos / miralls / ispiluak / espellos

### CAMERINO

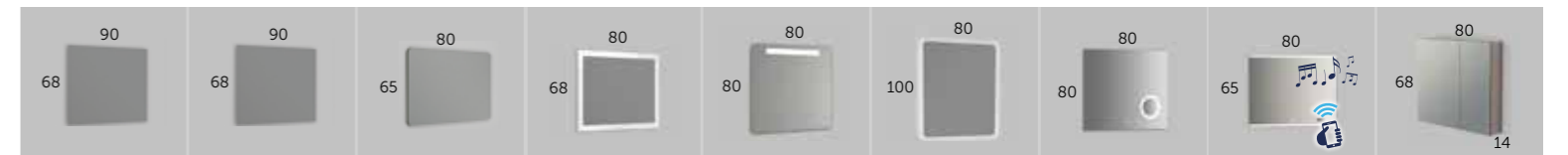

**MOON**  
 Referencia 200 00 090

**CLOUD**  
 Referencia 205 00 090

**SIGMA**  
 Referencia 290 00 080

**TOOL**  
 Referencia  
 ○ 207 01 080  
 ● 207 24 080

**RAIN LED**  
 Referencia 269 00 080

**VERONA LED**  
 Referencia 246 00 100

**HOLMES LED**  
 Referencia 263 00 080

**SPOTY LED**  
 Referencia 267 00 080

**FLASH**  
 Referencia 340 11 080

### AUXILIARES / auxiliary units / auxiliares / auxiliars / osagarriak / auxiliares

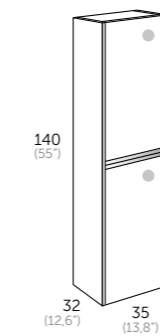

**JOKER** columna  
 Acabado Referencia  
 ○ Blanco 137 01 335  
 ● Roble natural 137 24 335  
 ● Nogal oscuro 137 39 335

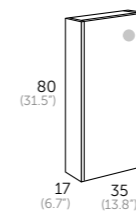

**JOKER** colgar  
 Acabado Referencia  
 ○ Blanco 137 01 435  
 ● Roble natural 137 24 435  
 ● Nogal oscuro 137 39 435

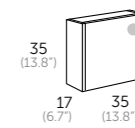

**JOKER** auxiliar  
 Acabado Referencia  
 ○ Blanco 137 01 445  
 ● Roble natural 137 24 445  
 ● Nogal oscuro 137 39 445



**Válvula universal CLIC CLAC**  
 Referencia 51601

Interior cajones acabado textil  
*Interior of drawer textile finish*  
 Interiores gaveta em acabamento têxtil  
 Interior calaix en acabat tèxtil  
 Ehun-bukaerazko barnekaldedun kajoia  
 Interior do caixón en acabado têxtil

Fronte cajón regulable  
*Adjustable front drawer*  
 Fronte da gaveta ajustável  
 Frontal calaix regulable  
 Neurrirako kajoia aurrekaldea  
 Fronte do caixón axustable

Cajón con cierre amortiguado  
*Drawer fitted with soft closing system*  
 Gaveta com sistema de corredeiras com amortecedor  
 Calaixos amb sistema de tancament suau  
 Motelgailudun itxierazko kajoia  
 Caixón con peche amortecido

Guías Hettich  
*Hettich drawer sliding system*  
 Guias Hettich  
 Hettich gidak  
 Guias Hettich

Puerta con cierre amortiguado  
*Door with soft closing system*  
 Porta com amortecedor  
 Porta amb sistema de tancament suau  
 Motelgailudun itxierazko atea  
 Porta con peche amortecido

Acabado melamina con textura  
*Textured melamine finish*  
 Cor melamina com textura  
 Acabat melamina amb textura  
 Testuradun melanina bukatua  
 Acabado melamina con textura

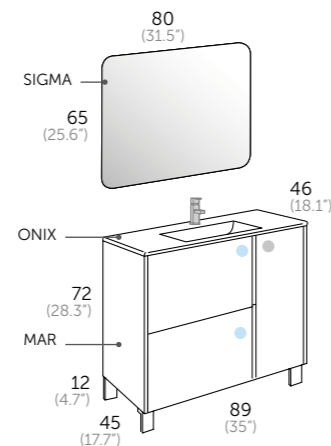

### Composición MAR 90 (35.4")

1 133 39 090 MAR 90  
 1 500 01 090 ONIX  
 1 290 00 080 SIGMA



### APLIQUES / spotlights / apliques / aplics / ezarkinak / apliques



**EVA LED**  
 Referencia 400 00 011

**NEREA mate LED**  
 Referencia 400 14 161  
 luz fría

**ESTHER LED**  
 Referencia 400 00 121  
 luz fría  
 400 00 221  
 luz cálida

**SOFIA LED**  
 Referencia 400 00 141  
 luz fría  
 400 00 241  
 luz cálida

**AINHOA LED**  
 Referencia 400 00 151  
 luz fría

**NIKITA LED**  
 Referencia 400 01 171  
 luz fría

**NAYRA LED**  
 Referencia 400 00 181  
 luz fría



# Hole

\_80/90/100

Sigma  
Omega  
Landes  
Landes modular  
Strip  
Cairo  
Dúo  
Ikaro  
Denim  
Lip  
Wave  
Sky  
Trent  
Escorpio  
Tauro  
Wood  
Mar  
**Hole\_**  
Aries  
Galsaky  
Small  
Homy  
Comet  
Tívoli  
Moon  
Dominó



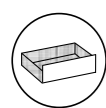

Interior cajones acabado textil  
*Interior of drawer textile finish*  
 Interiores gaveta em acabamento têxtil  
 Interior caiaix en acabat tèxtil  
 Ehun-bukaerazko barnekaldeun kajoia  
 Interior do caixón en acabado têxtil



Cajón con cierre amortiguado  
*Drawer fitted with soft closing system*  
 Gaveta com sistema de correções com amortecedor  
 Caiaixos amb sistema de tancament suau  
 Motelgailudun itxierazko kajoia  
 Caixón con peche amortecido

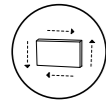

Frente cajón regulable  
*Adjustable front drawer*  
 Frente da gaveta ajustável  
 Frontal caiaix regulable  
 Neurritako kajoj aurrekaldea  
 Fronte do caixón axustable



Guías Hettich  
*Hettich drawer sliding system*  
 Guias Hettich  
 Guies Hettich  
 Hettich gidak  
 Guias Hettich

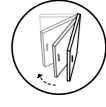

Puerta con cierre amortiguado  
*Door with soft closing system*  
 Porta com amortecedor  
 Porta amb sistema de tancament suau  
 Motelgailudun itxierazko atea  
 Porta con peche amortecido



Acabado melamina con textura  
*Textured melamine finish*  
 Cor melamina com textura  
 Acabát melamina amb textura  
 Testuradun melamina bukatua  
 Acabado melamina con textura

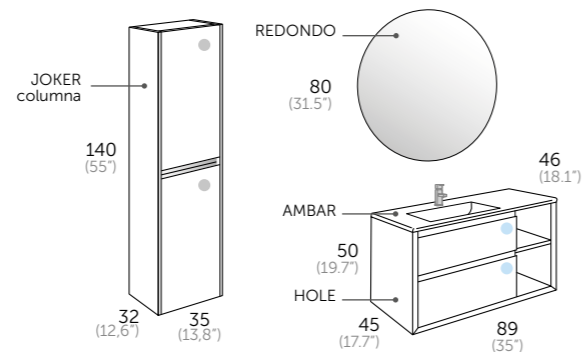

Composición **HOLE 90 (35.4")**

- 1 132 37 090 HOLE 90
- 1 506 01 092 AMBAR
- 1 244 00 080 REDONDO

Auxiliares

- 1 137 37 335 JOKER columna



Roble natural  
 Natural oak  
 Carvalho natural  
 Roure natural  
 Haritz naturala  
 Carballo natural

Pino gris  
 Grey pine  
 Pinho cinzento  
 Pi gris  
 Pinu grisa  
 Piñeiro gris



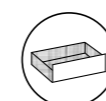

Interior cajones acabado textil  
 Interior of drawer textile finish  
 Interiores gaveta em acabamento têxtil  
 Interior calaix en acabat tèxtil  
 Ehun-bukaerazko barnekaldedun kajoia  
 Interior do caixón en acabado textil

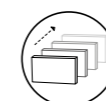

Cajón con cierre amortiguado  
 Drawer fitted with soft closing system  
 Gaveta com sistema de correijas com amortecedor  
 Calaixos amb sistema de tancament suau  
 Motelgailudun itxierazko kajoia  
 Caixón con peche amortecido

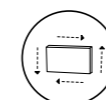

Fronte cajón regulable  
 Adjustable front drawer  
 Fronte da gaveta ajustável  
 Frontal calaix regulable  
 Neurrirako kajoj aurrekaldea  
 Fronte do caixón axustable



Guías Hettich  
 Hettich drawer sliding system  
 Guias Hettich  
 Guias Hettich  
 Hettich gidak  
 Hettich gidak  
 Guias Hettich



Puerta con cierre amortiguado  
 Door with soft closing system  
 Porta com amortecedor  
 Porta amb sistema de tancament suau  
 Motelgailudun itxierazko atea  
 Porta con peche amortecido

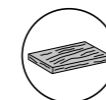

Acabado melamina con textura  
 Textured melamine finish  
 Cor melamina com textura  
 Acabat melamina amb textura  
 Testuradun melamina bukatua  
 Acabado melamina con textura

- Roble natural / Natural oak / Carvalho natural / Roure natural / Haritz naturala / Carballo natural
- Pino gris / Grey pine / Pinho cinzento / Pi gris / Pinu gris / Piñeiro gris

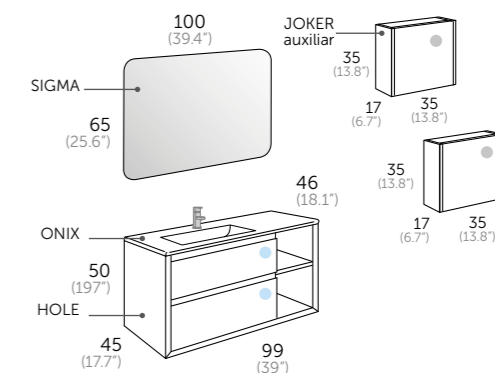

Composición **HOLE 100 (39.4")**

- 1 132 24 100 HOLE 100
- 1 500 01 101 ONIX
- 1 290 00 100 SIGMA

Auxiliares

- 2 137 24 445 JOKER Auxiliar



## HOLE\_80 (31.5")

ESPEJOS Y CAMERINOS más opciones en págs. 316 - 325

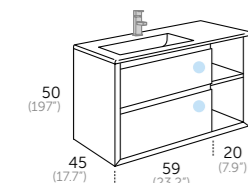

Acabado Referencia  
 ● Roble natural 132 24 080  
 ● Pino gris 132 37 080

### ENCIMERAS

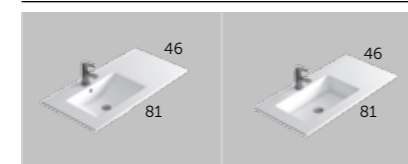

**ONIX** cerámica Referencia 500 01 081  
**AMBAR** mate Referencia 506 01 081

### ESPEJOS / mirrors / espelhos / miralls / ispiluak / espellos

### CAMERINO



**MOON** Referencia 200 00 080  
**CLOUD** Referencia 205 00 080  
**SIGMA** Referencia 290 00 080  
**TOOL** Referencia 207 24 080  
**RAIN LED** Referencia 269 00 080  
**VERONA LED** Referencia 246 00 100  
**HOLMES LED** Referencia 263 00 080  
**SPOTY LED** Referencia 267 00 080  
**FLASH** Referencia 340 11 080

## HOLE\_90 (35.4")

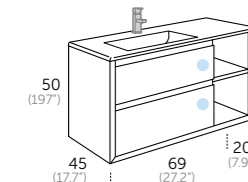

Acabado Referencia  
 ● Roble natural 132 24 090  
 ● Pino gris 132 37 090

### ENCIMERAS

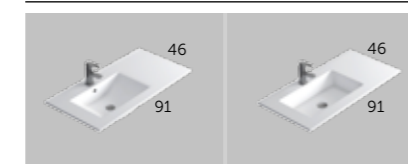

**ONIX** cerámica Referencia 500 01 091  
**AMBAR** mate Referencia 506 01 092

### ESPEJOS / mirrors / espelhos / miralls / ispiluak / espellos

### CAMERINO



**MOON** Referencia 200 00 090  
**CLOUD** Referencia 205 00 090  
**SIGMA** Referencia 290 00 080  
**TOOL** Referencia 207 24 080  
**RAIN LED** Referencia 269 00 080  
**VERONA LED** Referencia 246 00 100  
**HOLMES LED** Referencia 263 00 080  
**SPOTY LED** Referencia 267 00 080  
**FLASH** Referencia 340 11 080

## HOLE\_100 (39.4")

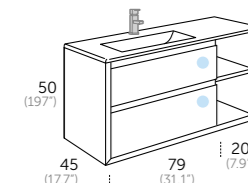

Acabado Referencia  
 ● Roble natural 132 24 100  
 ● Pino gris 132 37 100

### ENCIMERAS

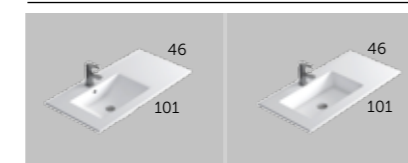

**ONIX** cerámica Referencia 500 01 101  
**AMBAR** mate Referencia 506 01 102

### ESPEJOS / mirrors / espelhos / miralls / ispiluak / espellos

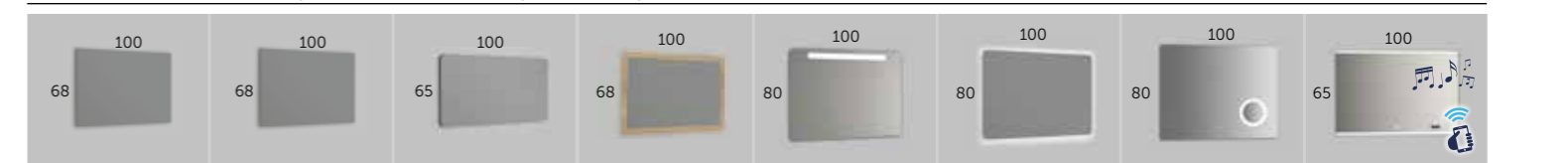

**MOON** Referencia 200 00 100  
**CLOUD** Referencia 205 00 100  
**SIGMA** Referencia 290 00 100  
**TOOL** Referencia 207 24 100  
**RAIN LED** Referencia 269 00 100  
**VERONA LED** Referencia 246 00 100  
**HOLMES LED** Referencia 263 00 100  
**SPOTY LED** Referencia 267 00 100

## AUXILIARES / auxiliary units / auxiliares / auxiliars / osagarriak / auxiliares

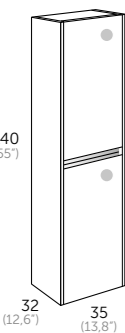

**JOKER** columna  
 Acabado Referencia  
 ● Roble natural 137 24 335  
 ● Pino gris 137 37 335

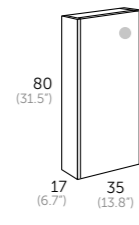

**JOKER** colgar  
 Acabado Referencia  
 ● Roble natural 137 24 435  
 ● Pino gris 137 37 435

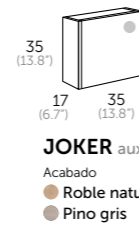

**JOKER** auxiliar  
 Acabado Referencia  
 ● Roble natural 137 24 445  
 ● Pino gris 137 37 445



**Válvula universal CLIC CLAC**  
 Referencia 51601

## APLIQUES / spotlights / apliques / aplics / ezarkinak / apliques



**EVA LED** Referencia 400 00 011  
**NEREA mate LED** Referencia 400 14 161 luz fría  
**ESTHER LED** Referencia 400 00 121 luz fría / 400 00 221 luz cálida  
**SOFIA LED** Referencia 400 00 141 luz fría / 400 00 241 luz cálida  
**AINHOA LED** Referencia 400 00 151 luz fría  
**NIKITA LED** Referencia 400 01 171 luz fría  
**NAYRA LED** Referencia 400 00 181 luz fría

\_70/80/100

# Aries

- Sigma
- Omega
- Landes
- Landes modular
- Strip
- Cairo
- Dúo
- Ikaro
- Denim
- Lip
- Wave
- Sky
- Trent
- Escorpio
- Tauro
- Wood
- Mar
- Hole
- Aries\_**
- Galsaky
- Small
- Homy
- Comet
- Tívoli
- Moon
- Dominó



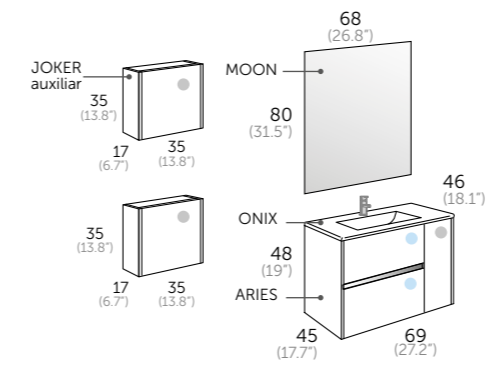

Composición **ARIES 70** (27.5")

- 1 121 01 070 ARIES 70
- 1 500 01 070 ONIX
- 1 200 00 080 MOON

Auxiliares

- 2 137 01 445 JOKER auxiliar

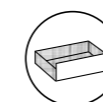

Interior cajones acabado textil  
*Interior of drawer textile finish*  
 Interiores gaveta em acabamento têxtil  
 Interior calaix en acabat tèxtil  
 Ehun-bukerazko barnekaldedun kajoia  
 Interior do caixón en acabado textil



Cajón con cierre amortiguado  
*Drawer fitted with soft closing system*  
 Gaveta com sistema de correções com amortecedor  
 Calaixos amb sistema de tancament suau  
 Motelgailudun itxierazko kajoia  
 Caixón con peche amortecido

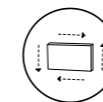

Frente cajón regulable  
*Adjustable front drawer*  
 Frente da gaveta ajustável  
 Frontal calaix regulable  
 Neurrirako kajoj aurrealdea  
 Fronte do caixón axustable



Guías Hettich  
*Hettich drawer sliding system*  
 Guias Hettich  
 Guies Hettich  
 Hettich gidak  
 Guias Hettich



Puerta con cierre amortiguado  
*Door with soft closing system*  
 Porta com amortecedor  
 Porta amb sistema de tancament suau  
 Motelgailudun itxierazko atea  
 Porta con peche amortecido

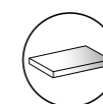

Acabado lacado brillo  
*High gloss lacquered finish*  
 Cor lacado brilho  
 Acabat lacat brillant  
 Distiradun lakatuzko bukatua  
 Acabado lacado brillo



- Blanco  
White  
Branco  
Blanc  
Zunja  
Branco
- Roble natural  
Natural oak  
Carvalho natural  
Roure natural  
Hartz naturala  
Carballo natural
- Roble medio  
Medium oak  
Carvalho médio  
Roure mitja  
Hartz ertainekoa  
Carballo medio
- Wengué  
Wenge  
Wengue  
Wenge  
Wengué

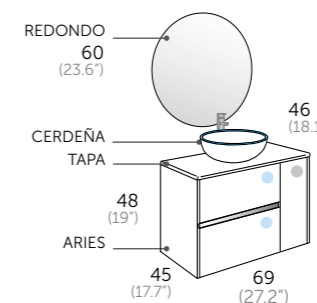

Composición **ARIES 70** (27.5")

- 1 121 01 070 ARIES 70
- 1 121 01 207 Tapa ARIES
- 1 507 01 040 CERDEÑA
- 1 244 00 060 REDONDO



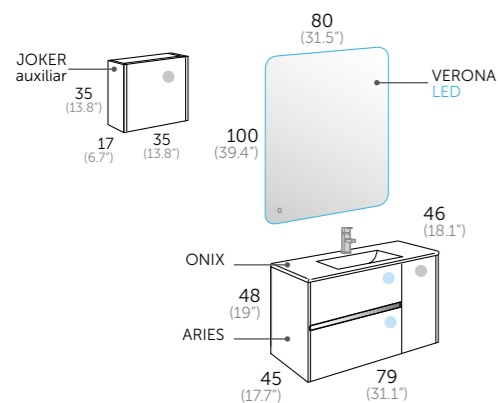

Composición **ARIES 80 (31.5")**

- 1 121 21 080 ARIES 80
- 1 500 01 080 ONIX
- 1 246 00 100 VERONA LED

Auxiliares

- 1 137 21 445 JOKER auxiliar

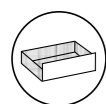

Interior cajones acabado textil  
Interior of drawer textile finish  
Interiores gaveta em acabamento têxtil  
Interior calaix en acabat tèxtil  
Ehun-bukaerazko barnekaldean kajoia  
Interior do caixón en acabado textil

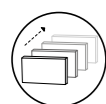

Cajón con cierre amortiguado  
Drawer fitted with soft closing system  
Gaveta com sistema de correções com amortecedor  
Calaixos amb sistema de tancament suau  
Motelgailudun itxierazko kajoia  
Caixón con peche amortecido

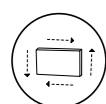

Frente cajón regulable  
Adjustable front drawer  
Frente da gaveta ajustável  
Frontal calaix regulable  
Neurrirako kajoí aurrekaldea  
Frente do caixón axustable



Guías Hettich  
Hettich drawer sliding system  
Guias Hettich  
Guias Hettich  
Hettich gidak  
Guias Hettich

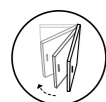

Puerta con cierre amortiguado  
Door with soft closing system  
Porta com amortecedor  
Porta amb sistema de tancament suau  
Motelgailudun itxierazko atea  
Porta con peche amortecido



Acabado melamina con textura  
Textured melamine finish  
Cor melamina com textura  
Acabat melamina amb textura  
Testuradun melamina bukatua  
Acabado melamina con textura



Sistema antivaho  
Anti fog system  
Sistema anti-vapor  
Sistema antibaf  
Lurrunaren kontrako sistema  
Sistema antivaho



Sensor de contacto On/ Off  
Contact sensor On/ Off  
Sensor interruptor On/ Off  
Sensor de contacte On/ Off  
On/Off kontaktu sentorea  
Sensor de contacto On/ Off

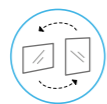

Reversible  
It is reversible  
Reversível  
Reversível  
Itzulgarria  
Reversibile



Luz ambiental  
Ambient light  
Luz ambiente  
Llum ambiental  
Giro-argia  
Luz ambiental



Blanco  
White  
Branco  
Blanc  
Zuri  
Branco

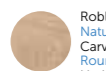

Roble natural  
Natural oak  
Carvalho natural  
Roure natural  
Haritz naturala  
Carballo natural

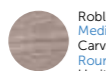

Roble medio  
Medium oak  
Carvalho médio  
Roure miúdo  
Haritz ertainekoa  
Carballo medio



Wengué  
Wenge  
Wengé  
Wenge  
Wengué



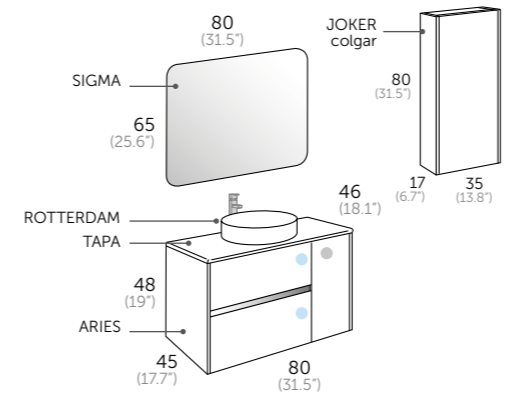

- Composición ARIES 80 (31.5")**
- 1 121 24 080 ARIES 80
  - 1 121 24 208 Tapa ARIES
  - 1 507 01 004 ROTTERDAM
  - 1 290 00 080 SIGMA

- Auxiliares**
- 1 137 24 435 JOKER colgar

- Blanco  
White  
Branco  
Blanc  
Zuria  
Branco
- Roble natural  
Natural oak  
Carvalho natural  
Roure natural  
Haritz naturala  
Carballo natural
- Roble medio  
Medium oak  
Carvalho médio  
Roure mitjà  
Haritz ertainekoa  
Carballo medio
- Wengué  
Wenge  
Wenge  
Wengue  
Wengue

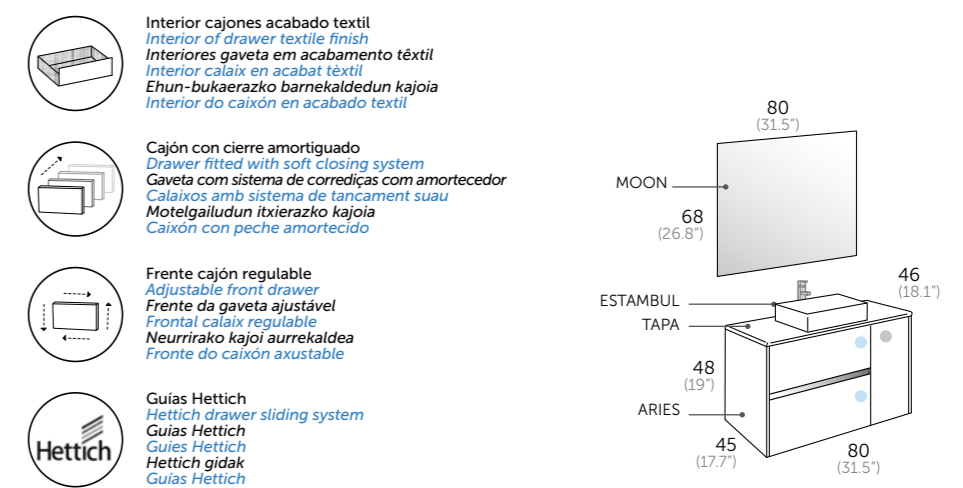

- Composición ARIES 80 (31.5")**
- 1 121 20 080 ARIES 80
  - 1 121 20 208 Tapa ARIES
  - 1 507 01 005 ESTAMBUL
  - 1 200 00 080 MOON

- Auxiliares**
- 1 137 24 435 JOKER colgar

- Interior cajones acabado textil  
*Interior of drawer textile finish*  
Interiores gaveta em acabamento têxtil  
*Interior calaix en acabat tèxtil*  
Ehun-bukaerazko barnekaldedun kajoia  
*Interior do caixón en acabado textil*
- Cajón con cierre amortiguado  
*Drawer fitted with soft closing system*  
Gaveta com sistema de correções com amortecedor  
*Calaixos amb sistema de tancament suau*  
Motelgailudun itxierazko kajoia  
*Caixón con peche amortecido*
- Frente cajón regulable  
*Adjustable front drawer*  
Frente da gaveta ajustável  
*Frontal calaix regulable*  
Neurrirako kajoï aurrekaldea  
*Fronte do caixón axustable*
- Guías Hettich  
*Hettich drawer sliding system*  
Guias Hettich  
*Guias Hettich*  
Hettich gidak  
*Hettich gidak*  
Guias Hettich
- Puerta con cierre amortiguado  
*Door with soft closing system*  
Porta com amortecedor  
*Porta amb sistema de tancament suau*  
Motelgailudun itxierazko atea  
*Porta con peche amortecido*
- Acabado melamina con textura  
*Textured melamine finish*  
Cor melamina com textura  
*Acabat melamina amb textura*  
Testuradun melanina bukatua  
*Acabado melanina con textura*



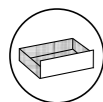

Interior cajones acabado textil  
*Interior of drawer textile finish*  
 Interiores gaveta em acabamento têxtil  
*Interior calaix en acabat tèxtil*  
 Ehun-bukaerazko barnekaldedun kajoia  
*Interior do caixón en acabado têxtil*



Cajón con cierre amortiguado  
*Drawer fitted with soft closing system*  
 Gaveta com sistema de correções com amortecedor  
*Calaixos amb sistema de tancament suau*  
 Motelgailudun itxierazko kajoia  
*Caixón con peche amortecido*

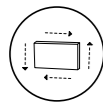

Frente cajón regulable  
*Adjustable front drawer*  
 Frente da gaveta ajustável  
*Frontal calaix regulable*  
 Neurrirako kajoï aurrekaldea  
*Fronte do caixón axustable*



Guías Hettich  
*Hettich drawer sliding system*  
 Guías Hettich  
*Guias Hettich*  
 Hettich gidak  
*Guias Hettich*

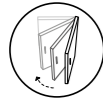

Puerta con cierre amortiguado  
*Door with soft closing system*  
 Porta com amortecedor  
*Porta amb sistema de tancament suau*  
 Motelgailudun itxierazko atea  
*Porta con peche amortecido*

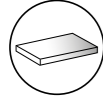

Acabado lacado brillo  
*High gloss lacquered finish*  
 Cor lacado brilho  
*Acabat lacat brillant*  
 Distiradun lakatzuzko bukatua  
*Acabado lacado brillo*

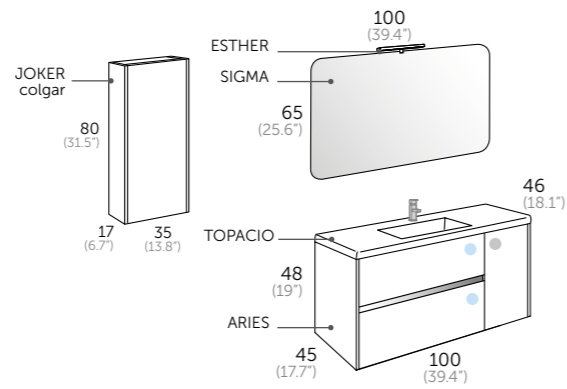

Composición **ARIES 100 (39.4)**

1	121	01	100	ARIES 100
1	505	01	100	TOPACIO
1	290	00	100	SIGMA
1	400	00	121	ESTHER

Auxiliares

1	137	01	435	JOKER colgar
---	-----	----	-----	--------------



Blanco  
 White  
 Branco  
 Zuria  
 Branco

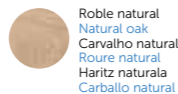

Roble natural  
 Natural oak  
 Carvalho natural  
 Roure natural  
 Haritz naturala  
 Carballo natural



Roble medio  
 Medium oak  
 Carvalho médio  
 Roure mitjà  
 Haritz ertainekoa  
 Carballo medio



Wengué  
 Wenge  
 Wengué  
 Wenge  
 Wengué



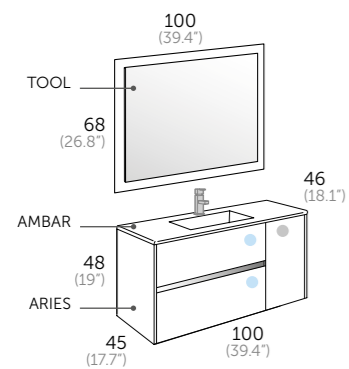

Composición **ARIES 100** (39.4')

- 1 121 24 100 ARIES 100
- 1 506 01 100 AMBAR
- 1 207 24 100 TOOL



- Blanco  
White  
Branco  
Blanc  
Zuria  
Branco
- Roble natural  
Natural oak  
Carvalho natural  
Roure natural  
Haritz naturala  
Carballo natural
- Roble medio  
Medium oak  
Carvalho médio  
Roure miña  
Haritz ertainekoa  
Carballo medio
- Wengué  
Wenge  
Wengué  
Wenge  
Wengué

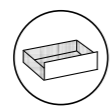

Interior cajones acabado textil  
*Interior of drawer textile finish*  
Interiores gaveta em acabamento têxtil  
*Interior calaix en acabat tèxtil*  
Ehun-bukaerazko barnekalde duna kajoia  
*Interior do caixón en acabado textil*



Cajón con cierre amortiguado  
*Drawer fitted with soft closing system*  
Gaveta com sistema de corredeiras com amortecedor  
*Calaixos amb sistema de tancament suau*  
Motelgailudun itxierazko kajoia  
*Caixón con peche amortecido*

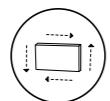

Frente cajón regulable  
*Adjustable front drawer*  
Frente da gaveta ajustável  
*Frontal calaix regulable*  
Neurrirako kajoj aurrekaldea  
*Fronte do caixón axustable*



Guías Hettich  
*Hettich sliding system*  
Guías Hettich  
*Guias Hettich*  
Hettich gidak  
*Guias Hettich*



Puerta con cierre amortiguado  
*Door with soft closing system*  
Porta com amortecedor  
*Porta amb sistema de tancament suau*  
Motelgailudun itxierazko atea  
*Porta con peche amortecido*



Acabado melamina con textura  
*Textured melamine finish*  
Cor melamina com textura  
*Acabat melamina amb textura*  
Testuradun melanina bukatua  
*Acabado melanina con textura*



- Blanco  
White  
Branco  
Blanc  
Zuria  
Branco

- Roble natural  
Natural oak  
Carvalho natural  
Roure natural  
Haritz naturala  
Carballo natural

- Roble medio  
Medium oak  
Carvalho médio  
Roure miña  
Haritz ertainekoa  
Carballo medio

- Wengué  
Wenge  
Wengué  
Wenge  
Wengué

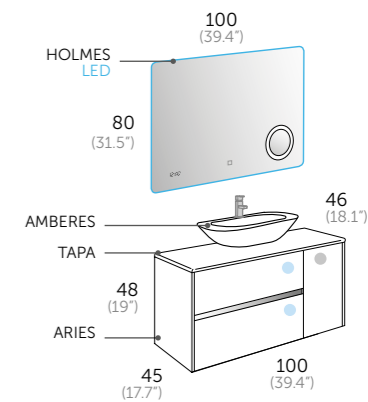

Composición **ARIES 100** (39.4')

- 1 121 21 100 ARIES 100
- 1 121 21 210 Tapa ARIES
- 1 507 01 003 AMBERES
- 1 263 00 100 HOLMES LED



Sistema antivaho  
*Anti fog system*  
Sistema anti-vapor  
*Sistema antibaf*  
Lurrunaren kontrako sistema  
*Sistema antivaho*



Sensor de contacto On/ Off  
*Contact sensor On/ Off*  
Sensor interruptor On/ Off  
*Sensor de contacte On/ Off*  
On/Off kontaktu sentorea  
*Sensor de contacto On/ Off*



Reloj digital  
*Digital clock*  
Relógio digital  
*Relotxe digital*  
Erioju digital  
*Reloxo dixital*



Lupa aumento x3  
*Magnifying zoom in Mirror*  
Lupa aumento 3x  
*Lupa augment 3x*  
3x-eko haundiagotze lupa  
*Lupa aumento x3*

## ARIES\_70 (27.5")

ESPEJOS Y CAMERINOS | más opciones en págs. 316 - 325

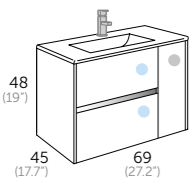

Acabado	Referencia
○ Blanco	121 01 070
● Roble natural	121 24 070
● Roble medio	121 21 070
● Wengué	121 20 070

### ENCIMERAS / countertops / lavatorios / lavabos / gainekoak / encimeras



<b>ONIX</b> cerámica	<b>TOPACIO</b>	<b>JADE</b>	<b>AMBAR</b> mate	<b>MASAI</b>	<b>CRISTAL</b>
Referencia 500 01 070	Referencia 505 01 070	Referencia 504 01 070	Referencia 506 01 070	Referencia 518 02 070 Más colores en pág. 308-311	Acabado Referencia Metalizado Negro 502 11 070 502 02 070

### ESPEJOS / mirrors / espelhos / miralls / ispiluak / espellos

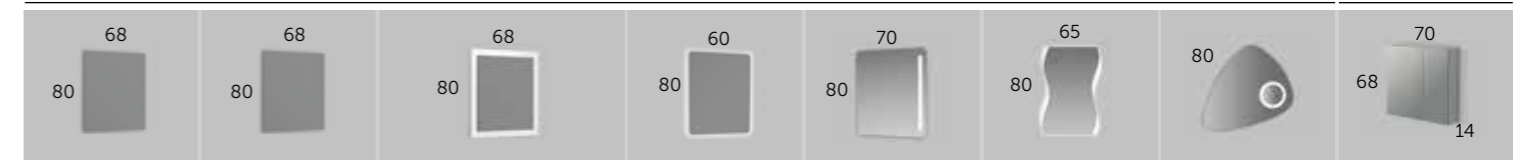

<b>MOON</b>	<b>CLOUD</b>	<b>TOOL</b>	<b>VERONA LED</b>	<b>MILAN LED</b>	<b>MÓDENA LED</b>	<b>STONE LED</b>	<b>FLASH</b>
Referencia 200 00 080	Referencia 205 00 080	Acabado Referencia ○ Blanco 207 01 080 ● Roble natural 207 24 080 ● Roble medio 207 21 080	Referencia 246 00 060	Referencia 268 00 080	Referencia 264 00 080	Referencia 261 00 080	Referencia 340 11 070

## ARIES\_80 (31.5")

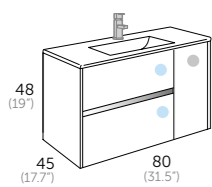

Acabado	Referencia
○ Blanco	121 01 080
● Roble natural	121 24 080
● Roble medio	121 21 080
● Wengué	121 20 080

### ENCIMERAS / countertops / lavatorios / lavabos / gainekoak / encimeras

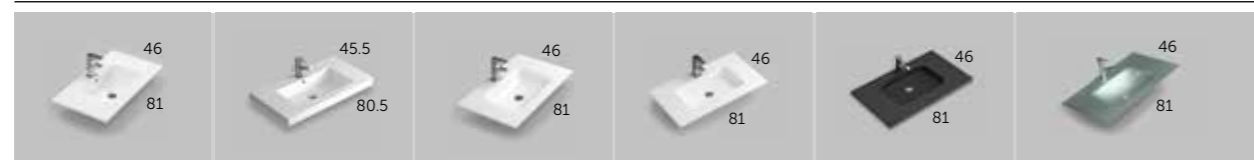

<b>ONIX</b> cerámica	<b>TOPACIO</b> resina	<b>JADE</b> masa blanca	<b>AMBAR</b> mate	<b>MASAI</b>	<b>CRISTAL</b>
Referencia 500 01 080	Referencia 505 01 080	Referencia 504 01 080	Referencia 506 01 080	Referencia 518 02 080 Más colores en pág. 308-311	Acabado Referencia Metalizado Negro 502 11 080 502 02 080

### ESPEJOS / mirrors / espelhos / miralls / ispiluak / espellos



<b>MOON</b>	<b>CLOUD</b>	<b>SIGMA</b>	<b>TOOL</b>	<b>RAIN LED</b>	<b>VERONA LED</b>	<b>HOLMES LED</b>	<b>SPOTY LED</b>	<b>FLASH</b>
Referencia 200 00 080	Referencia 205 00 080	Referencia 290 00 080	Referencia ○ 207 01 080 ○ 207 24 080 ● 207 21 080	Referencia 269 00 080	Referencia 246 00 100	Referencia 263 00 080	Referencia 267 00 080	Referencia 340 11 080

## ARIES\_100 (39.4")

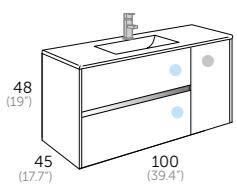

Acabado	Referencia
○ Blanco	121 01 100
● Roble natural	121 24 100
● Roble medio	121 21 100
● Wengué	121 20 100

### ENCIMERAS / countertops / lavatorios / lavabos / gainekoak / encimeras



<b>ONIX</b> cerámica	<b>SKY</b>	<b>TOPACIO</b> resina	<b>JADE</b> masa blanca	<b>AMBAR</b> mate	<b>MASAI</b>
Referencia 500 01 100	Referencia 517 01 100	Referencia 505 01 100	Referencia 504 01 100	Referencia 506 01 100	Referencia 518 02 100 Más colores en pág. 308-311

### ESPEJOS / mirrors / espelhos / miralls / ispiluak / espellos

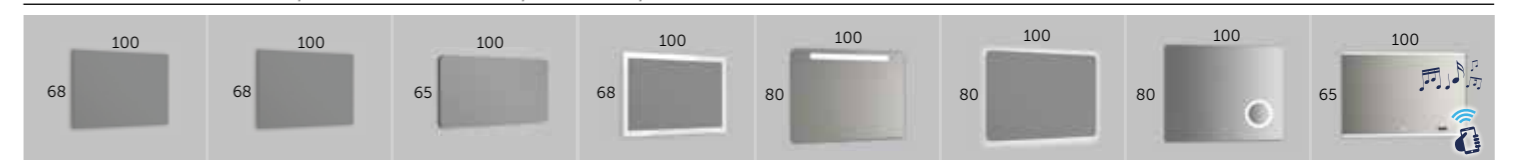

<b>MOON</b>	<b>CLOUD</b>	<b>SIGMA</b>	<b>TOOL</b>	<b>RAIN LED</b>	<b>VERONA LED</b>	<b>HOLMES LED</b>	<b>SPOTY LED</b>
Referencia 200 00 100	Referencia 205 00 100	Referencia 290 00 100	Referencia ○ 207 01 100 ● 207 24 100 ● 207 21 100	Referencia 269 00 100	Referencia 246 00 100	Referencia 263 00 100	Referencia 267 00 100

## ARIES TAPA

tops / tampos / tapes / eztalkiak / tapas



○ Blanco	● Roble natural
Medida Referencia	Medida Referencia
70 x 45 121 01 207	70 x 45 121 24 207
80 x 45 121 01 208	80 x 45 121 24 208
100 x 45 121 01 210	100 x 45 121 24 210
● Roble medio	● Wengué
Medida Referencia	Medida Referencia
70 x 45 121 21 207	70 x 45 121 20 207
80 x 45 121 21 208	80 x 45 121 20 208
100 x 45 121 21 210	100 x 45 121 20 210

### LAVABOS / washbasins / lavatorio pousar / lavabo sobreposar / gainjarritako konketa / lavabo sobrepoñer

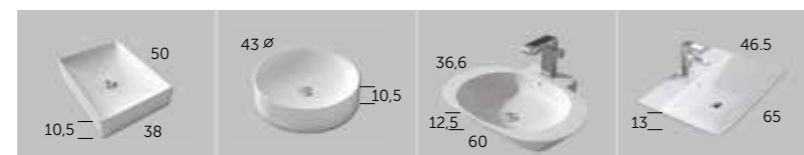

<b>ESTAMBUL</b>	<b>ROTTERDAM</b>	<b>AMBERES</b>	<b>LANDES</b>
Referencia 507 01 005	Referencia 507 01 004	Referencia 507 01 003	Referencia 507 01 002
Altura 10,5 cm	Altura 10,5 cm	Altura 12,5	Altura 13

más opciones en págs. 314 - 315

### AUXILIARES / auxiliary units / auxiliares / auxiliars / osagarriak / auxiliares

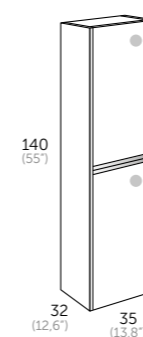

<b>JOKER</b> columna
Acabado Referencia
○ Blanco 137 01 335
● Roble natural 137 24 335
● Roble medio 137 21 335
● Wengué 137 20 335

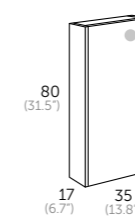

<b>JOKER</b> colgar
Acabado Referencia
○ Blanco 137 01 435
● Roble natural 137 24 435
● Roble medio 137 21 435
● Wengué 137 20 435

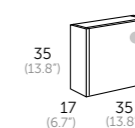

<b>JOKER</b> auxiliar
Acabado Referencia
○ Blanco 137 01 445
● Roble natural 137 24 445
● Roble medio 137 21 445
● Wengué 137 20 445

### APLIQUES



**ESTHER LED**  
Referencia  
400 00 121  
luz fría  
400 00 221  
luz cálida

más opciones en pág. 326



- Sigma
- Omega
- Landes
- Landes modular
- Strip
- Cairo
- Dúo
- Ikaro
- Denim
- Lip
- Wave
- Sky
- Trent
- Escorpio
- Tauro
- Wood
- Mar
- Hole
- Aries
- Galsaky\_**
- Small
- Homy
- Comet
- Tivoli
- Moon
- Dominó

# Galsaky

\_60/70/80/100

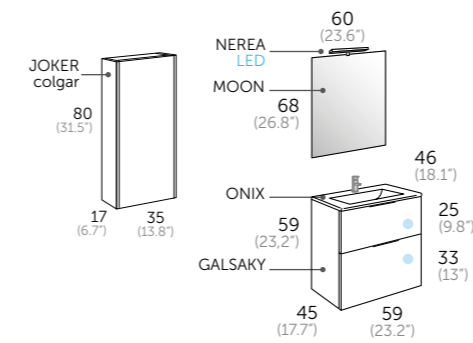

Composición **GALSAKY 60** (23.6")

- 1 151 39 060 GALSAKY 60
- 1 500 01 060 ONIX
- 1 200 00 060 MOON
- 1 400 14 161 NEREA

Auxiliares

- 1 137 39 435 JOKER colgar

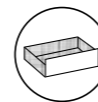

Interior cajones acabado textil  
*Interior of drawer textile finish*  
 Interiores gaveta em acabamento têxtil  
*Interior calaix en acabat tèxtil*  
 Ehun-bukaerazko barnekaldeedun kajoia  
*Interior do caixón en acabado textil*

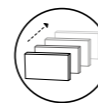

Cajón con cierre amortiguado  
*Drawer fitted with soft closing system*  
 Gaveta com sistema de corrediças com amortecedor  
*Caixaos amb sistema de tancament suau*  
 Motelgailudun itxierazko kajoia  
*Caixón con peche amortecido*

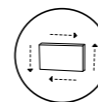

Frente cajón regulable  
*Adjustable front drawer*  
 Frente da gaveta ajustável  
*Frontal calaix regulable*  
 Neurrirako kajoï aurrekaldea  
*Fronte do caixón axustable*



Puerta con cierre amortiguado  
*Door with soft closing system*  
 Porta com amortecedor  
*Porta amb sistema de tancament suau*  
 Motelgailudun itxierazko atea  
*Porta con peche amortecido*

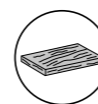

Acabado melamina con textura  
*Textured melamine finish*  
 Cor melamina com textura  
*Acabat melamina amb textura*  
 Testuradun melamina bukatua  
*Acabado melamina con textura*



Guías Hettich  
*Hettich drawer sliding system*  
 Guias Hettich  
*Guias Hettich*  
 Hettich gidak  
*Guias Hettich*

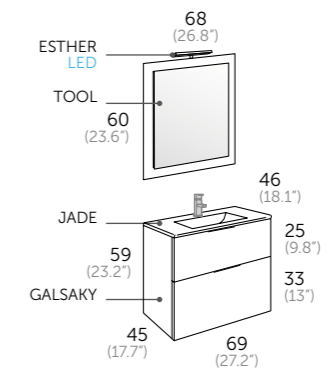
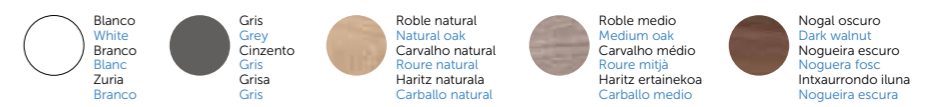

Composición **GALSAKY 70** (27.5")

- 1 151 21 070 GALSAKY 70
- 1 504 01 070 JADE
- 1 207 21 060 TOOL
- 1 400 00 121 ESTHER



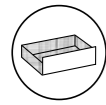

Interior cajones acabado textil  
*Interior of drawer textile finish*  
 Interiores gaveta em acabamento têxtil  
*Interior calaix en acabat tèxtil*  
 Ehun-bukaerazko barnekaldedun kajoia  
*Interior do caixón en acabado têxtil*



Cajón con cierre amortiguado  
*Drawer fitted with soft closing system*  
 Gaveta com sistema de corredeiras com amortecedor  
*Calaixos amb sistema de tancament suau*  
 Motelgailudun itxierazko kajoia  
*Caixón con peche amortecido*

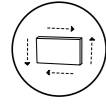

Frente cajón regulable  
*Adjustable front drawer*  
 Frente da gaveta ajustável  
*Frontal calaix regulable*  
 Neurritako kajoj aurrekaldea  
*Fronte do caixón axustable*

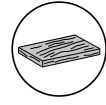

Acabado melamina con textura  
*Textured melamine finish*  
 Cor melamina con textura  
*Acabat melamina amb textura*  
 Testuradun melamina bukatua  
*Acabado melamina con textura*



Guías Hettich  
*Hettich drawer sliding system*  
 Guías Hettich  
 Guías Hettich  
 Hettich gidak  
 Guías Hettich

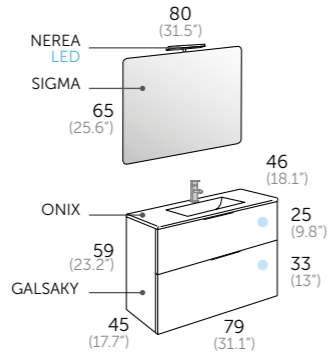

Composición **GALSACY 80 (31.5")**

- 1 151 24 080 GALSACY 80
- 1 500 01 080 ONIX
- 1 290 00 080 SIGMA
- 1 400 14 161 NEREA



Blanco  
 White  
 Branco  
 Blanc  
 Zuria  
 Branco



Gris  
 Grey  
 Cinzento  
 Gris  
 Grisa  
 Gris

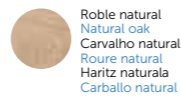

Roble natural  
 Natural oak  
 Carvalho natural  
 Roure natural  
 Haritz naturala  
 Carballo natural

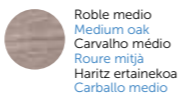

Roble medio  
 Medium oak  
 Carvalho médio  
 Roure mitjà  
 Haritz ertainekoa  
 Carballo medio

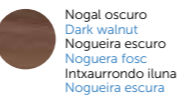

Nogal oscuro  
 Dark walnut  
 Nogueira escuro  
 Nogueira fosc  
 Intxaurreondo iluna  
 Nogueira escura



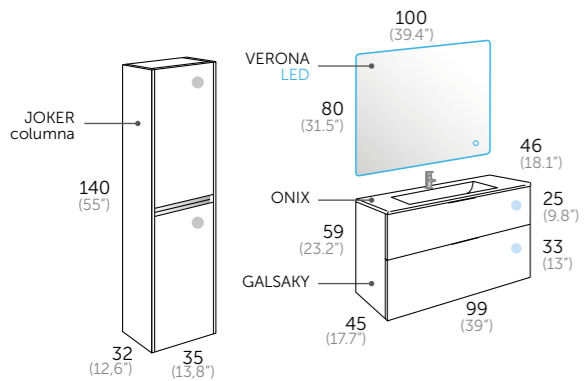

Composición **GALSACY 100** (39.4")

- 1 151 01 100 GALSACY 100
- 1 500 01 100 ONIX
- 1 246 00 100 VERONA LED

Auxiliares

- 1 137 01 335 JOKER columna

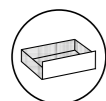

Interior cajones acabado textil  
*Interior of drawer textile finish*  
 Interiores gaveta em acabamento têxtil  
*Interior calaix en acabat tèxtil*  
 Ehun-bukaerazko barnekaldean kajoia  
*Interior do caixón en acabado têxtil*

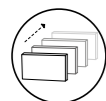

Cajón con cierre amortiguado  
*Drawer fitted with soft closing system*  
 Gaveta com sistema de corredeiras com amortecedor  
*Calaixos amb sistema de tancament suau*  
 Motelgailudun itxierazko kajoia  
*Caixón con peche amortecido*

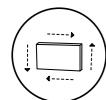

Frente cajón regulable  
*Adjustable front drawer*  
 Frente da gaveta ajustável  
*Frontal calaix regulable*  
 Neurrirako kajoj aurrekaldea  
*Fronte do caixón axustable*

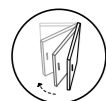

Puerta con cierre amortiguado  
*Door with soft closing system*  
 Porta com amortecedor  
*Porta amb sistema de tancament suau*  
 Motelgailudun itxierazko atea  
*Porta con peche amortecido*

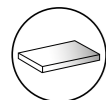

Acabado lacado brillo  
*High gloss lacquered finish*  
 Cor lacado brilho  
*Acabat lacat brillant*  
 Distiradun lakatuzko bukatua  
*Acabado lacado brillo*



Guías Hettich  
*Hettich drawer sliding system*  
 Guias Hettich  
 Guies Hettich  
 Hettich gidak  
 Guias Hettich



Sistema antivaho  
*Anti fog system*  
 Sistema anti-vapor  
*Sistema antibaf*  
 Lurrunaren kontrako sistema  
*Sistema antivaho*



Sensor de contacto On/ Off  
*Contact sensor On/ Off*  
 Sensor interruptor On/ Off  
*Sensor de contacte On/ Off*  
 On/Off kontaktu sentsoarea  
*Sensor de contacto On/ Off*



Reversible  
*It is reversible*  
 Reversível  
*Reversível*  
 Itzugarria  
*Reversibile*



Luz ambiental  
*Ambient light*  
 Luz ambiente  
*Lum ambiental*  
 Giro-argia  
*Luz ambiental*

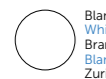

Blanco  
 White  
 Branco  
 Blanc  
 Zuria  
 Branco



Gris  
 Grey  
 Cinzento  
 Roure natural  
 Grisa  
 Gris

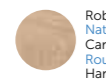

Roble natural  
 Natural oak  
 Carvalho natural  
 Roure natural  
 Haritz naturala  
 Carballo natural

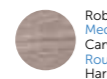

Roble medio  
 Medium oak  
 Carvalho médio  
 Roure mitjà  
 Haritz ertainekoa  
 Carballo medio

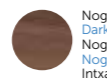

Nogal oscuro  
 Dark walnut  
 Nogueira escuro  
 Nogueira fosc  
 Intxaurreondo iluna  
 Nogueira escura



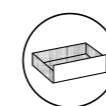

Interior cajones acabado textil  
 Interior of drawer textile finish  
 Interiores gaveta em acabamento têxtil  
 Interior calaix en acabat tèxtil  
 Ehun-bukaerazko barnekaldedun kajoia  
 Interior do caixón en acabado textil

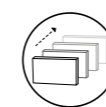

Cajón con cierre amortiguado  
 Drawer fitted with soft closing system  
 Gaveta com sistema de correções com amortecedor  
 Calaixos amb sistema de tancament suau  
 Motelgailudun itxierazko kajoia  
 Caixón con peche amortecido

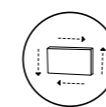

Frente cajón regulable  
 Adjustable front drawer  
 Frente da gaveta ajustável  
 Frontal calaix regulable  
 Neurrirako kajoj aurrekaldea  
 Fronte do caixón axustable

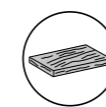

Acabado melamina con textura  
 Textured melamine finish  
 Cor melamina con textura  
 Acabat melamina amb textura  
 Texturadun melamina bukatua  
 Acabado melamina con textura



Guías Hettich  
 Hettich drawer sliding system  
 Guías Hettich  
 Guies Hettich  
 Hettich gidak  
 Guías Hettich

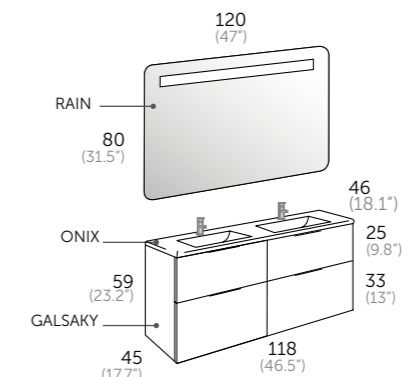

Composición **GALSACY 120 (47.2")**

2 151 39 060 GALSACY 60  
 1 500 01 122 ONIX  
 1 269 00 120 RAIN



Blanco  
 White  
 Branco  
 Blanc  
 Zuria  
 Branco

Grís  
 Grey  
 Cinzento  
 Gris  
 Grisa  
 Gris

Roble natural  
 Natural oak  
 Carvalho natural  
 Roure natural  
 Haritz naturala  
 Carballo natural

Roble medio  
 Medium oak  
 Carvalho médio  
 Roure mitjà  
 Haritz ertainekoa  
 Carballo medio

Nogal oscuro  
 Dark walnut  
 Nogueira escuro  
 Nogueira fosc  
 Intxaurreondo iluna  
 Nogueira escura



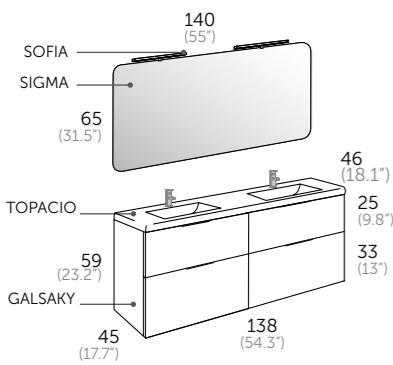

Composición **GALSAKY 140 (55")**

2	151 03 070	GALSAKY 70
1	505 01 142	TOPACIO
1	290 00 140	SIGMA
2	400 00 141	SOFIA

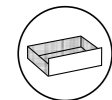

Interior cajones acabado textil  
*Interior of drawer textile finish*  
 Interiores gaveta em acabamento têxtil  
*Interior calaix en acabat tèxtil*  
 Ehun-bukerazko barnekaldedun kajoia  
*Interior do caixón en acabado têxtil*

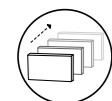

Cajón con cierre amortiguado  
*Drawer fitted with soft closing system*  
 Gaveta com sistema de corrediças com amortecedor  
*Calaixos amb sistema de tancament suau*  
 Motelgailudun itxierazko kajoia  
*Caixón con peche amortecido*

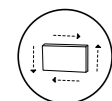

Frente cajón regulable  
*Adjustable front drawer*  
 Frente da gaveta ajustável  
*Frontal calaix regulable*  
 Neurritako kajo aurrekaldea  
*Fronte do caixón axustable*

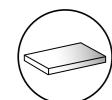

Acabado lacado brillo  
*High gloss lacquered finish*  
 Cor lacado brilho  
*Acabat lacat brillant*  
 Distiradun lakatuzko bukatua  
*Acabado lacado brillo*



Guías Hettich  
*Hettich drawer sliding system*  
 Guías Hettich  
 Guies Hettich  
 Hettich gidak  
 Guías Hettich



Blanco  
 White  
 Branco  
 Blanc  
 Zuria  
 Branco



Gris  
 Grey  
 Cinzento  
 Gris  
 Grisa  
 Gris

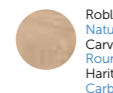

Roble natural  
 Natural oak  
 Carvalho natural  
 Roure natural  
 Haritz naturala  
 Carballo natural

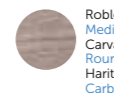

Roble medio  
 Medium oak  
 Carvalho médio  
 Roure mitjà  
 Haritz ertainekoa  
 Carballo medio

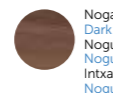

Nogal oscuro  
 Dark walnut  
 Nogueira escuro  
 Nogueira fosc  
 Intxaurreondo iluna  
 Nogueira escura



## GALSAKY\_60 (23.6")

ESPEJOS Y CAMERINOS | más opciones en págs. 316 - 325

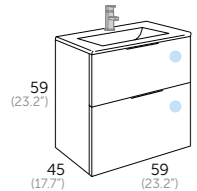

- Acabado Referencia  
 ○ Blanco 151 01 060  
 ● Gris 151 03 060  
 ● Roble natural 151 24 060  
 ● Roble medio 151 21 060  
 ● Nogal oscuro 151 39 060

### ENCIMERAS / countertops / lavatorios / lavabos / gaineoak / encimeras



- |   |  |  |  |   |
|---|--|--|--|---|
| <b>ONIX</b> cerámica<br>Referencia 500 01 060 | <b>TOPACIO</b> resina<br>Referencia 505 01 060 | <b>JADE</b> masa blanca<br>Referencia 504 01 060 | <b>MASAI</b><br>Referencia 518 02 060<br>Más colores en pág. 308-311 | <b>CRISTAL</b><br>Acabado Referencia<br>Metalizado Negro 502 02 060 |
|---|--|--|--|---|

### ESPEJOS / mirrors / espelhos / miralls / ispiluak / espellos

### CAMERINO



- |                                      |                                       |   |   |  |  |  |                                       |
|--------------------------------------|---------------------------------------|---|---|--|--|--|---------------------------------------|
| <b>MOON</b><br>Referencia 200 00 060 | <b>CLOUD</b><br>Referencia 205 00 060 | <b>REDONDO</b><br>Referencia 244 00 060 | <b>TOOL</b><br>Acabado Referencia<br>○ Blanco 207 01 060<br>● Gris 207 03 060<br>● Roble natural 207 24 060<br>● Roble medio 207 21 060 | <b>RAIN LED</b><br>Referencia 269 00 060 | <b>VERONA LED</b><br>Referencia 246 00 060 | <b>MÓDENA LED</b><br>Referencia 264 00 080 | <b>FLASH</b><br>Referencia 340 11 060 |
|--------------------------------------|---------------------------------------|---|---|--|--|--|---------------------------------------|

## GALSAKY\_70 (27.5")

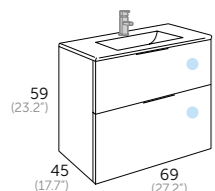

- Acabado Referencia  
 ○ Blanco 151 01 070  
 ● Gris 151 03 070  
 ● Roble natural 151 24 070  
 ● Roble medio 151 21 070  
 ● Nogal oscuro 151 39 070

### ENCIMERAS / countertops / lavatorios / lavabos / gaineoak / encimeras

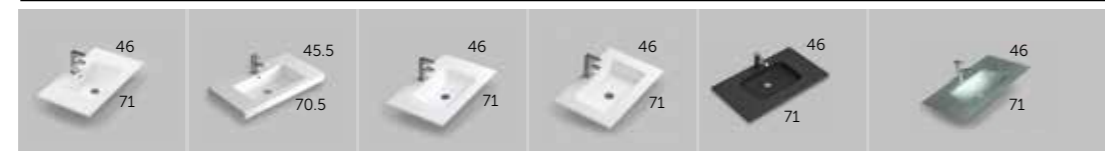

- |   |   |                                      |  |  |   |
|---|---|--------------------------------------|--|--|---|
| <b>ONIX</b> cerámica<br>Referencia 500 01 070 | <b>TOPACIO</b><br>Referencia 505 01 070 | <b>JADE</b><br>Referencia 504 01 070 | <b>AMBAR mate</b><br>Referencia 506 01 070 | <b>MASAI</b><br>Referencia 518 02 070<br>Más colores en pág. 308-311 | <b>CRISTAL</b><br>Acabado Referencia<br>Metalizado Negro 502 02 070 |
|---|---|--------------------------------------|--|--|---|

### ESPEJOS / mirrors / espelhos / miralls / ispiluak / espellos

### CAMERINO



- |                                      |                                       |   |  |   |  |   |                                       |
|--------------------------------------|---------------------------------------|---|--|---|--|---|---------------------------------------|
| <b>MOON</b><br>Referencia 200 00 080 | <b>CLOUD</b><br>Referencia 205 00 080 | <b>TOOL</b><br>Acabado Referencia<br>○ Blanco 207 01 080<br>● Gris 207 03 080<br>● Roble natural 207 24 080<br>● Roble medio 207 21 080 | <b>VERONA LED</b><br>Referencia 246 00 060 | <b>MILAN LED</b><br>Referencia 268 00 080 | <b>MÓDENA LED</b><br>Referencia 264 00 080 | <b>STONE LED</b><br>Referencia 261 00 080 | <b>FLASH</b><br>Referencia 340 11 070 |
|--------------------------------------|---------------------------------------|---|--|---|--|---|---------------------------------------|

## GALSAKY\_80 (31.5")

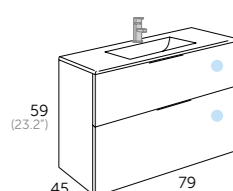

- Acabado Referencia  
 ○ Blanco 151 01 080  
 ● Gris 151 03 080  
 ● Roble natural 151 24 080  
 ● Roble medio 151 21 080  
 ● Nogal oscuro 151 39 080

### ENCIMERAS / countertops / lavatorios / lavabos / gaineoak / encimeras

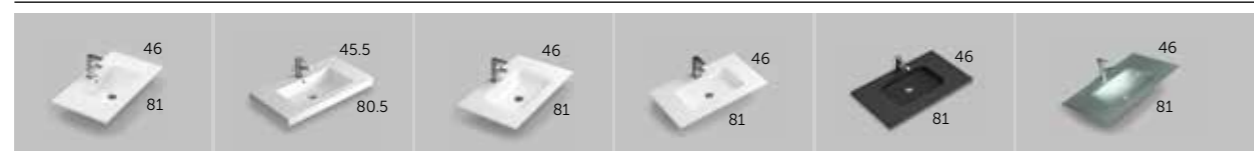

- |   |  |  |  |  |   |
|---|--|--|--|--|---|
| <b>ONIX</b> cerámica<br>Referencia 500 01 080 | <b>TOPACIO</b> resina<br>Referencia 505 01 080 | <b>JADE</b> masa blanca<br>Referencia 504 01 080 | <b>AMBAR mate</b><br>Referencia 506 01 080 | <b>MASAI</b><br>Referencia 518 02 080<br>Más colores en pág. 308-311 | <b>CRISTAL</b><br>Acabado Referencia<br>Metalizado Negro 502 02 080 |
|---|--|--|--|--|---|

### ESPEJOS / mirrors / espelhos / miralls / ispiluak / espellos

### CAMERINO



- |                                      |                                       |                                       |   |  |  |  |   |                                       |
|--------------------------------------|---------------------------------------|---------------------------------------|---|--|--|--|---|---------------------------------------|
| <b>MOON</b><br>Referencia 200 00 080 | <b>CLOUD</b><br>Referencia 205 00 080 | <b>SIGMA</b><br>Referencia 290 00 080 | <b>TOOL</b><br>Referencia<br>○ 207 01 080<br>● 207 03 080<br>● 207 24 080<br>● 207 21 080 | <b>RAIN LED</b><br>Referencia 269 00 080 | <b>VERONA LED</b><br>Referencia 246 00 100 | <b>HOLMES LED</b><br>Referencia 263 00 080 | <b>SPOTY LED</b><br>Referencia 267 00 080 | <b>FLASH</b><br>Referencia 340 11 080 |
|--------------------------------------|---------------------------------------|---------------------------------------|---|--|--|--|---|---------------------------------------|

## GALSAKY\_100 (39.4")

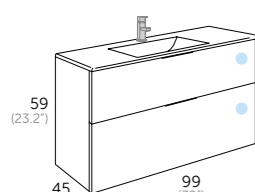

- Acabado Referencia  
 ○ Blanco 151 01 100  
 ● Gris 151 03 100  
 ● Roble natural 151 24 100  
 ● Roble medio 151 21 100  
 ● Nogal oscuro 151 39 100

### ENCIMERAS / countertops / lavatorios / lavabos / gaineoak / encimeras



- |   |                                     |  |  |  |  |
|---|-------------------------------------|--|--|--|--|
| <b>ONIX</b> cerámica<br>Referencia 500 01 100 | <b>SKY</b><br>Referencia 517 01 100 | <b>TOPACIO</b> resina<br>Referencia 505 01 100 | <b>JADE</b> masa blanca<br>Referencia 504 01 100 | <b>AMBAR mate</b><br>Referencia 506 01 100 | <b>MASAI</b><br>Referencia 518 02 100<br>Más colores en pág. 308-311 |
|---|-------------------------------------|--|--|--|--|

### ESPEJOS / mirrors / espelhos / miralls / ispiluak / espellos

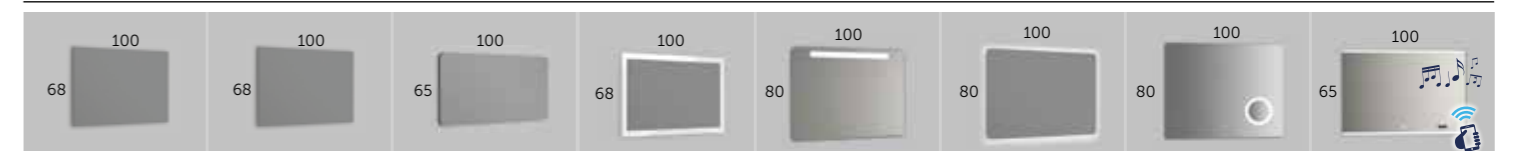

- |                                      |                                       |                                       |   |  |  |  |   |
|--------------------------------------|---------------------------------------|---------------------------------------|---|--|--|--|---|
| <b>MOON</b><br>Referencia 200 00 100 | <b>CLOUD</b><br>Referencia 205 00 100 | <b>SIGMA</b><br>Referencia 290 00 100 | <b>TOOL</b><br>Referencia<br>○ 207 01 100<br>● 207 03 100<br>● 207 24 100<br>● 207 21 100 | <b>RAIN LED</b><br>Referencia 269 00 100 | <b>VERONA LED</b><br>Referencia 246 00 100 | <b>HOLMES LED</b><br>Referencia 263 00 100 | <b>SPOTY LED</b><br>Referencia 267 00 100 |
|--------------------------------------|---------------------------------------|---------------------------------------|---|--|--|--|---|

## GALSAKY\_120 (60+60) (47.2")

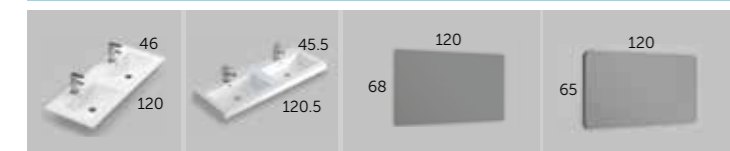

- |   |   |                                       |                                       |
|---|---|---------------------------------------|---------------------------------------|
| <b>ONIX</b> cerámica<br>Referencia 500 01 122 | <b>TOPACIO</b><br>Referencia 505 01 122 | <b>CLOUD</b><br>Referencia 205 00 120 | <b>SIGMA</b><br>Referencia 290 00 120 |
|---|---|---------------------------------------|---------------------------------------|

## GALSAKY\_140 (70+70) (55")



- |   |  |                                       |
|---|--|---------------------------------------|
| <b>TOPACIO</b><br>Referencia 505 01 142 | <b>AMBAR mate</b><br>Referencia 506 01 142 | <b>SIGMA</b><br>Referencia 290 00 140 |
|---|--|---------------------------------------|

## AUXILIARES / auxiliary units / auxiliares / auxiliars / osagarriak / auxiliares

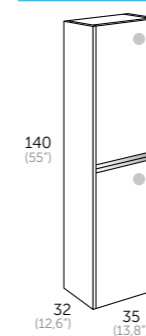

- JOKER** columna  
 Acabado Referencia  
 ○ Blanco 137 01 335  
 ● Gris 137 03 335  
 ● Roble natural 137 24 335  
 ● Roble medio 137 21 335  
 ● Nogal oscuro 137 39 335

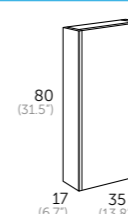

- JOKER** colgar  
 Acabado Referencia  
 ○ Blanco 137 01 435  
 ● Gris 137 03 435  
 ● Roble natural 137 24 435  
 ● Roble medio 137 21 435  
 ● Nogal oscuro 137 39 435

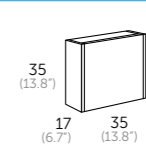

- JOKER** auxiliar  
 Acabado Referencia  
 ○ Blanco 137 01 445  
 ● Gris 137 03 445  
 ● Roble natural 137 24 445  
 ● Roble medio 137 21 445  
 ● Nogal oscuro 137 39 445

## APLIQUES



- ESTHER LED**  
 Referencia 400 00 121 luz fría  
 400 00 221 luz cálida

más opciones en pág. 326

Sigma  
 Omega  
 Landes  
 Landes modular  
 Strip  
 Cairo  
 Dúo  
 Ikaro  
 Denim  
 Lip  
 Wave  
 Sky  
 Trent  
 Escorpio  
 Tauro  
 Wood  
 Mar  
 Hole  
 Aries  
 Galsaky  
**Small\_**  
 Homy  
 Comet  
 Tívoli  
 Moon  
 Dominó

- 

Interior cajones acabado textil  
*Interior of drawer textile finish*  
 Interiores gaveta em acabamento têxtil  
*Interior calaix en acabat tèxtil*  
 Ehun-bukaerazko barnekaldeudun kajoia  
*Interior do caixón en acabado textil*
- 

Cajón con cierre amortiguado  
*Drawer fitted with soft closing system*  
 Gaveta com sistema de correções com amortecedor  
*Calaixos amb sistema de tancament suau*  
 Motelgailudun itxierazko kajoia  
*Caixón con peche amortecido*
- 

Frente cajón regulable  
*Adjustable front drawer*  
 Frente da gaveta ajustável  
*Frontal calaix regulable*  
 Neurrirako kajo aurrekaldea  
*Fronte do caixón axustable*
- 

Puerta con cierre amortiguado  
*Door with soft closing system*  
 Porta com amortecedor  
*Porta amb sistema de tancament suau*  
 Motelgailudun itxierazko atea  
*Porta con peche amortecido*
- 

Acabado lacado brillo  
*High gloss lacquered finish*  
 Cor lacado brillo  
*Acabat lacat brillant*  
 Distiradun lakatzuzko bukatua  
*Acabado lacado brillo*
- 

Guías Hettich  
*Hettich drawer sliding system*  
 Guías Hettich  
*Guías Hettich*  
 Hettich gidak  
*Guías Hettich*

- 

Bianco  
 White  
 Branco  
 Blanc  
 Zuria  
 Branco
- 

Roble natural  
 Natural oak  
 Carvalho natural  
 Roure natural  
 Haritz naturala  
 Carballo natural

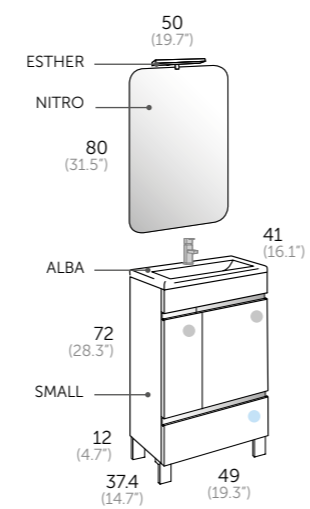

Composición **SMALL 50 (20")**

1	135 01 050	SMALL 50
1	510 01 050	ALBA
1	241 00 050	NITRO
1	400 00 121	ESTHER

# Small

**fondo reducido**

\_50/60



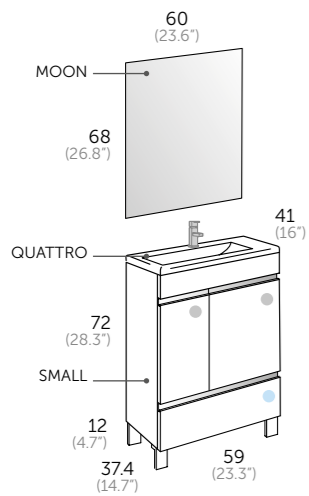

Composición **SMALL 60 (23.6")**

- 1 135 24 060 SMALL 60
- 1 520 01 060 QUATTRO
- 1 200 00 060 MOON

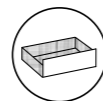

Interior cajones acabado textil  
*Interior of drawer textile finish*  
 Interiores gaveta em acabamento têxtil  
 Interior caixas en acabat tèxtil  
 Ehun-bukaerazko barnekaldedun kajoia  
 Interior do caixón en acabado textil

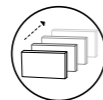

Cajón con cierre amortiguado  
*Drawer fitted with soft closing system*  
 Gaveta com sistema de corrediças com amortecedor  
 Caixaos amb sistema de tancament suau  
 Motelgailudun itxierazko kajoia  
 Caixón con peche amortecido

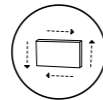

Frente cajón regulable  
*Adjustable front drawer*  
 Frente da gaveta ajustável  
 Frontal caixas regulable  
 Neurrirako kajoj aurrekaldea  
 Fronte do caixón axustable



Puerta con cierre amortiguado  
*Door with soft closing system*  
 Porta com amortecedor  
 Porta amb sistema de tancament suau  
 Motelgailudun itxierazko atea  
 Porta con peche amortecido

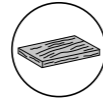

Acabado melamina con textura  
*Textured melamine finish*  
 Cor melamina com textura  
 Acabat melamina amb textura  
 Testuradun melanina bukatua  
 Acabado melanina con textura



Guías Hettich  
*Hettich drawer sliding system*  
 Guias Hettich  
 Guies Hettich  
 Hettich gidak  
 Guías Hettich



Blanco  
 White  
 Branco  
 Blanc  
 Zuria  
 Branco



Roble natural  
 Natural oak  
 Carvalho natural  
 Roure natural  
 Haritz naturala  
 Carballo natural



## SMALL\_50 (20")

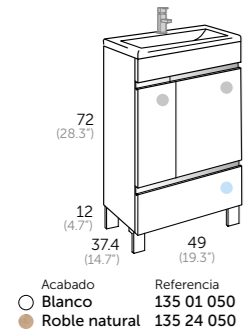

### ENCIMERA



**ALBA** cerámica  
Referencia  
510 01 050

Acabado Referencia  
○ Blanco 135 01 050  
● Roble natural 135 24 050

## ESPEJOS / mirrors / espelhos / miralls / ispiluak / espellos

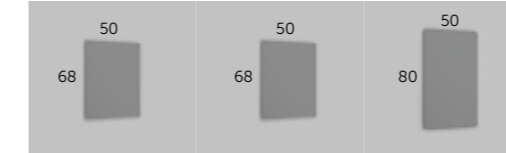

**MOON**  
Referencia  
200 00 050

**CLOUD**  
Referencia  
205 00 050

**NITRO**  
Referencia  
241 00 050

## SMALL\_60 (23.6")

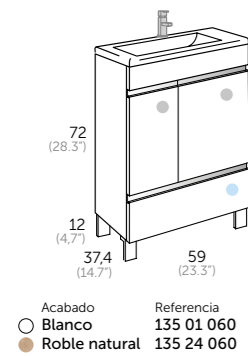

### ENCIMERA



**QUATTRO** cerámica  
Referencia  
520 01 060

Acabado Referencia  
○ Blanco 135 01 060  
● Roble natural 135 24 060

ESPEJOS Y CAMERINOS | más opciones en págs. 316 - 325

## ESPEJOS / mirrors / espelhos / miralls / ispiluak / espellos



**MOON**  
Referencia  
200 00 060

**CLOUD**  
Referencia  
205 00 060

**REDONDO**  
Referencia  
244 00 060

**TOOL**  
Acabado Referencia  
○ Blanco 207 01 060  
● Roble natural 207 24 060

**RAIN LED**  
Referencia  
269 00 060

**VERONA LED**  
Referencia  
246 00 060

**MÓDENA LED**  
Referencia  
264 00 080

**FLASH**  
Referencia  
340 11 060

### CAMERINO

## AUXILIARES / auxiliary units / auxiliares / auxiliars / osagarriak / auxiliares

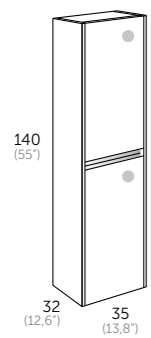

**JOKER** columna  
Acabado Referencia  
○ Blanco 137 01 335  
● Roble natural 137 24 335

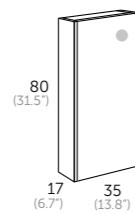

**JOKER** colgar  
Acabado Referencia  
○ Blanco 137 01 435  
● Roble natural 137 24 435

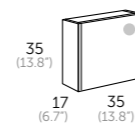

**JOKER** auxiliar  
Acabado Referencia  
○ Blanco 137 01 445  
● Roble natural 137 24 445



**Válvula universal**  
**CLIC CLAC**  
Referencia  
51601

## APLIQUES / spotlights / apliques / aplics / ezarkinak / apliques



**EVA LED**  
Referencia  
400 00 011

**NEREA mate LED**  
Referencia  
400 14 161  
luz fría

**ESTHER LED**  
Referencia  
400 00 121  
luz fría  
400 00 221  
luz cálida

**SOFIA LED**  
Referencia  
400 00 141  
luz fría  
400 00 241  
luz cálida

**AINHOA LED**  
Referencia  
400 00 151  
luz fría

**NIKITA LED**  
Referencia  
400 01 171  
luz fría

**NAYRA LED**  
Referencia  
400 00 181  
luz fría

# Homy

\_70/80

## fondo reducido

- Sigma
- Omega
- Landes
- Landes modular
- Strip
- Cairo
- Dúo
- Ikaro
- Denim
- Lip
- Wave
- Sky
- Trent
- Escorpio
- Tauro
- Wood
- Mar
- Hole
- Aries
- Galsaky
- Small
- Homy\_**
- Comet
- Tívoli
- Moon
- Dominó

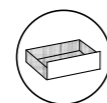

Interior cajones acabado textil  
*Interior of drawer textile finish*  
 Interiores gaveta em acabamento têxtil  
 Interior caiaix en acabat tèxtil  
 Ehun-bukaerazko barnekaldedun kajoia  
 Interior do caixón en acabado textil

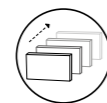

Cajón con cierre amortiguado  
*Drawer fitted with soft closing system*  
 Gaveta com sistema de correções com amortecedor  
 Caiaixos amb sistema de tancament suau  
 Motelgailudun itxierazko kajoia  
 Caixón con peche amortecido

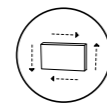

Frente cajón regulable  
*Adjustable front drawer*  
 Frente da gaveta ajustável  
 Frontal caiaix regulable  
 Neurrirako kajoj aurrekaldea  
 Fronte do caixón axustable



Guías Hettich  
*Hettich drawer sliding system*  
 Guías Hettich  
 Guies Hettich  
 Hettich gidak  
 Guías Hettich

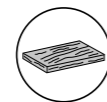

Acabado melamina con textura  
*Textured melamine finish*  
 Cor melamina com textura  
 Acabat melamina amb textura  
 Testuradun melanina bukatua  
 Acabado melanina con textura



Blanco  
 White  
 Branco  
 Blanc  
 Zuria  
 Branco



Roble natural  
 Natural oak  
 Carvalho natural  
 Roure natural  
 Haritz naturala  
 Carballo natural

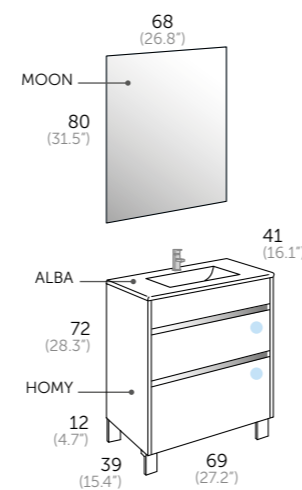

Composición **HOMY 70** (27.5")

- 1 136 24 070 HOMY 70
- 1 510 01 070 ALBA
- 1 200 00 080 MOON



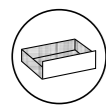

Interior cajones acabado textil  
*Interior of drawer textile finish*  
 Interiores gaveta em acabamento têxtil  
*Interior calaix en acabat tèxtil*  
 Ehun-bukaezako barnekaldeudun kajoia  
*Interior do caixón en acabado têxtil*

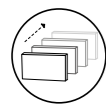

Cajón con cierre amortiguado  
*Drawer fitted with soft closing system*  
 Gaveta com sistema de corredeiras com amortecedor  
*Calaixos amb sistema de tancament suau*  
 Motelgailudun itxierazko kajoia  
*Caixón con peche amortecido*

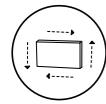

Frente cajón regulable  
*Adjustable front drawer*  
 Frente da gaveta ajustável  
*Frontal calaix regulable*  
 Neurrirako kajoï aurrekaldea  
*Fronte do caixón axustable*

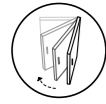

Puerta con cierre amortiguado  
*Door with soft closing system*  
 Porta com amortecedor  
*Porta amb sistema de tancament suau*  
 Motelgailudun itxierazko atea  
*Porta con peche amortecido*

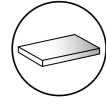

Acabado lacado brillo  
*High gloss lacquered finish*  
 Cor lacado brillo  
*Acabat lacat brillant*  
 Distiradun lakatuzko bukatua  
*Acabado lacado brillo*



Guías Hettich  
*Hettich drawer sliding system*  
 Guias Hettich  
 Guies Hettich  
 Hettich gidak  
 Guias Hettich

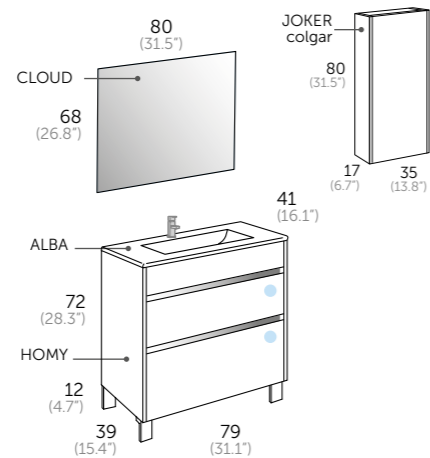

Composición **HOMY 80 (31.5")**

- 1 136 01 080 HOMY 80
- 1 510 01 080 ALBA
- 1 205 00 080 CLOUD

Auxiliares

- 1 135 01 435 JOKER colgar



Blanco  
 White  
 Branco  
 Blanc  
 Zunia  
 Branco



Roble natural  
 Natural oak  
 Carvalho natural  
 Roure natural  
 Haritz naturala  
 Carballo natural



## HOMY\_70 (27.5")

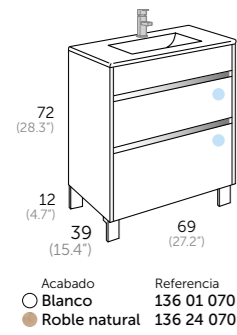

### ENCIMERAS / countertops / lavatorio



**ALBA** cerámica  
Referencia  
510 01 070

Acabado Referencia  
○ Blanco 136 01 070  
● Roble natural 136 24 070

### ESPEJOS / mirrors / espelhos / miralls / ispiluak / espellos

### CAMERINO

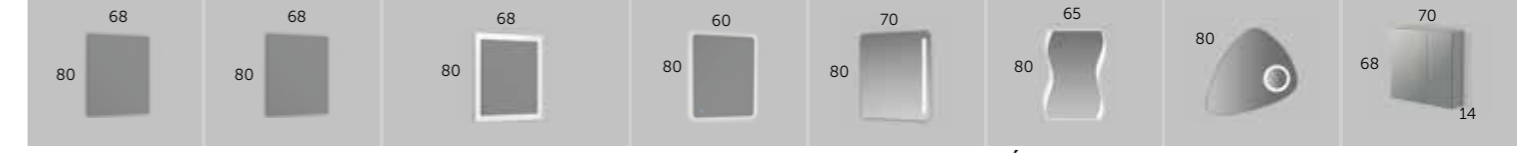

**MOON**  
Referencia  
200 00 080

**CLOUD**  
Referencia  
205 00 080

**TOOL**  
Acabado Referencia  
○ Blanco 207 01 080  
● Roble natural 207 24 080

**VERONA LED**  
Referencia  
246 00 060

**MILAN LED**  
Referencia  
268 00 080

**MÓDENA LED**  
Referencia  
264 00 080

**STONE LED**  
Referencia  
261 00 080

**FLASH**  
Referencia  
340 11 070

## HOMY\_80 (31.5")

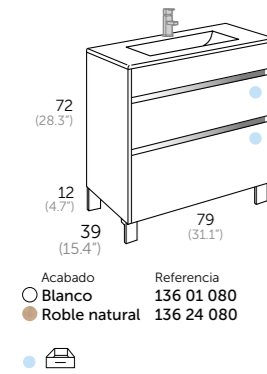

### ENCIMERAS / countertops / lavatorio



**ALBA** cerámica  
Referencia  
510 01 080

Acabado Referencia  
○ Blanco 136 01 080  
● Roble natural 136 24 080

### ESPEJOS / mirrors / espelhos / miralls / ispiluak / espellos

### CAMERINO



**MOON**  
Referencia  
200 00 080

**CLOUD**  
Referencia  
205 00 080

**SIGMA**  
Referencia  
290 00 080

**TOOL**  
Referencia  
○ 207 01 080  
● 207 24 080

**RAIN LED**  
Referencia  
269 00 080 137

**VERONA LED**  
Referencia  
246 00 100

**HOLMES LED**  
Referencia  
263 00 080

**SPOTY LED**  
Referencia  
267 00 080

**FLASH**  
Referencia  
340 11 080

## AUXILIARES / auxiliary units / auxiliares / auxiliars / osagarriak / auxiliares

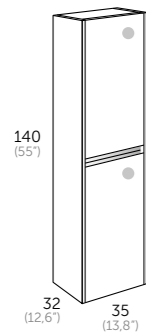

**JOKER** columna  
Acabado Referencia  
○ Blanco 137 01 335  
● Roble natural 137 24 335

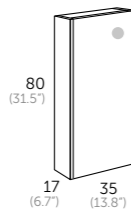

**JOKER** colgar  
Acabado Referencia  
○ Blanco 137 01 435  
● Roble natural 137 24 435

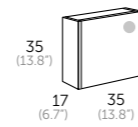

**JOKER** auxiliar  
Acabado Referencia  
○ Blanco 137 01 445  
● Roble natural 137 24 445



**Válvula universal**  
**CLIC CLAC**  
Referencia  
51601

## APLIQUES / spotlights / apliques / aplics / ezarkinak / apliques



**EVA LED**  
Referencia  
400 00 011

**NEREA mate LED**  
Referencia  
400 14 161  
luz fría

**ESTHER LED**  
Referencia  
400 00 121  
luz fría  
400 00 221  
luz cálida

**SOFIA LED**  
Referencia  
400 00 141  
luz fría  
400 00 241  
luz cálida

**AINHOA LED**  
Referencia  
400 00 151  
luz fría

**NIKITA LED**  
Referencia  
400 01 171  
luz fría

**NAYRA LED**  
Referencia  
400 00 181  
luz fría



\_60/70/80

# Comet

## fondo reducido

- Sigma
- Omega
- Landes
- Landes modular
- Strip
- Cairo
- Dúo
- Ikaro
- Denim
- Lip
- Wave
- Sky
- Trent
- Escorpio
- Tauro
- Wood
- Mar
- Hole
- Aries
- Galsaky
- Small
- Homy
- Comet\_**
- Tívoli
- Moon
- Dominó

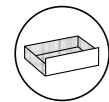

Interior cajones acabado textil  
 Interior of drawer textile finish  
 Interiores gaveta em acabamento têxtil  
 Interior calaix en acabat tèxtil  
 Ehun-bukaerazko barnekaldedun kajoia  
 Interior do caixón en acabado têxtil

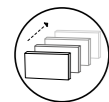

Cajón con cierre amortiguado  
 Drawer fitted with soft closing system  
 Gaveta com sistema de correções com amortecedor  
 Calaixos amb sistema de tancament suau  
 Motelgailudun itxierazko kajoia  
 Caixón con peche amortecido

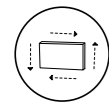

Frente cajón regulable  
 Adjustable front drawer  
 Frente da gaveta ajustável  
 Frontal calaix regulable  
 Neurrirako kajoï aurrekaldea  
 Fronte do caixón axustable

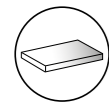

Acabado lacado brillo  
 High gloss lacquered finish  
 Cor lacado brilho  
 Acabat lacat brillant  
 Distiradun lakatuzko bukatua  
 Acabado lacado brillo



Guías Hettich  
 Hettich drawer sliding system  
 Guias Hettich  
 Guies Hettich  
 Hettich gidak  
 Guias Hettich

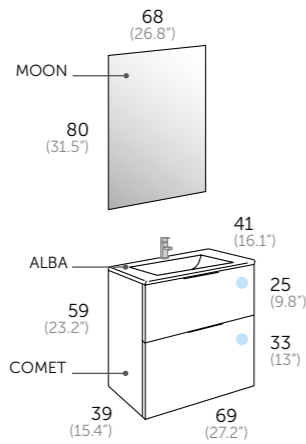

### Composición COMET 70 (27.5')

- 1 152 01 070 COMET 70
- 1 510 01 070 ALBA
- 1 200 00 080 MOON



Blanco  
 White  
 Branco  
 Blanc  
 Zuria  
 Branco



Roble natural  
 Natural oak  
 Carvalho natural  
 Roure natural  
 Haritz naturala  
 Carballo natural







- 

Interior cajones acabado textil  
*Interior of drawer textile finish*  
 Interiores gaveta em acabamento têxtil  
*Interior calaix en acabat tèxtil*  
 Ehun-bukaerazko barnekaldedun kajoia  
*Interior do caixón en acabado têxtil*
- 

Cajón con cierre amortiguado  
*Drawer fitted with soft closing system*  
 Gaveta com sistema de correijas com amortecedor  
*Calaixos amb sistema de tancament suau*  
 Motelgailudun itxierazko kajoia  
*Caixón con peche amortecido*
- 

Frente cajón regulable  
*Adjustable front drawer*  
 Frente da gaveta ajustável  
*Frontal calaix regulable*  
 Neurrirako kajoï aurrekaldea  
*Fronte do caixón axustable*
- 

Puerta con cierre amortiguado  
*Door with soft closing system*  
 Porta com amortecedor  
*Porta amb sistema de tancament suau*  
 Motelgailudun itxierazko atea  
*Porta con peche amortecido*
- 

Acabado melamina con textura  
*Textured melamine finish*  
 Cor melamina com textura  
*Acabat melamina amb textura*  
 Testuradun melamina bukatua  
*Acabado melamina con textura*

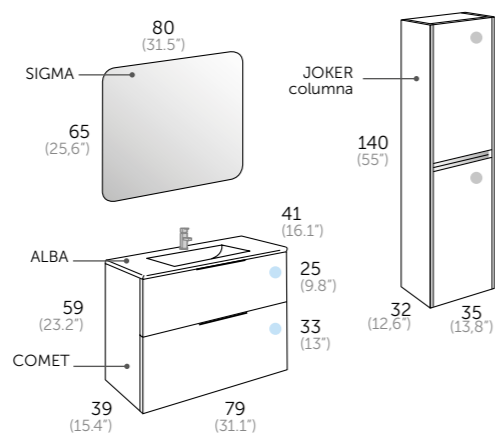
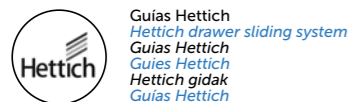

Composición **COMET 80 (31.5")**

- 1 152 24 080 COMET 80
- 1 510 01 080 ALBA
- 1 290 00 080 SIGMA

Auxiliares

- 1 135 24 335 JOKER Columna



## COMET\_60 (23.6")

ESPEJOS Y CAMERINOS más opciones en págs. 316 - 325

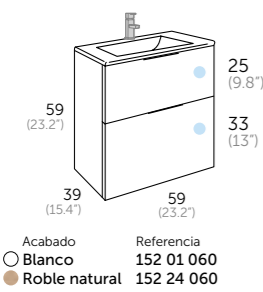

### ENCIMERA



**ALBA** cerámica  
Referencia  
510 01 060

Acabado Referencia  
○ Blanco 152 01 060  
● Roble natural 152 24 060

### ESPEJOS / mirrors / espelhos / miralls / ispiluak / espellos

### CAMERINO



<b>MOON</b> Referencia 200 00 060	<b>CLOUD</b> Referencia 205 00 060	<b>REDONDO</b> Referencia 244 00 060	<b>TOOL</b> Acabado Referencia ○ Blanco 207 01 060 ● Roble natural 207 24 060	<b>RAIN LED</b> Referencia 269 00 060	<b>VERONA LED</b> Referencia 246 00 060	<b>MÓDENA LED</b> Referencia 264 00 080	<b>FLASH</b> Referencia 340 11 060
---	--	--	--	---	---	---	--

## COMET\_70 (27.5")

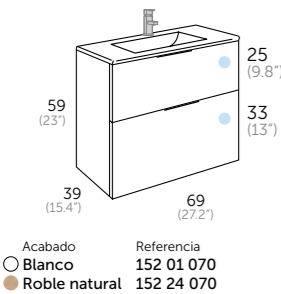

### ENCIMERA

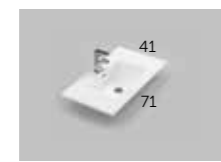

**ALBA** cerámica  
Referencia  
510 01 070

Acabado Referencia  
○ Blanco 152 01 070  
● Roble natural 152 24 070

### ESPEJOS / mirrors / espelhos / miralls / ispiluak / espellos

### CAMERINO

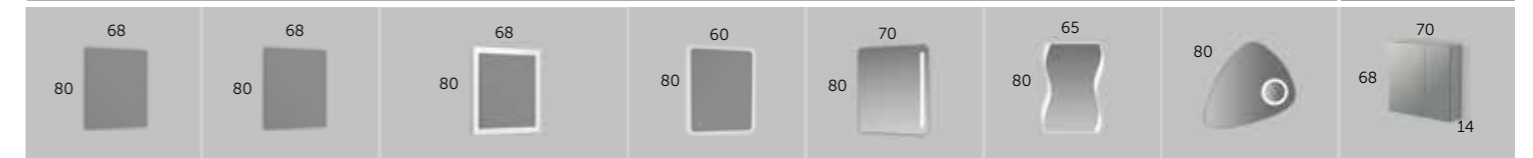

<b>MOON</b> Referencia 200 00 080	<b>CLOUD</b> Referencia 205 00 080	<b>TOOL</b> Acabado Referencia ○ Blanco 207 01 080 ● Roble natural 207 24 080	<b>VERONA LED</b> Referencia 246 00 060	<b>MILAN LED</b> Referencia 268 00 080	<b>MÓDENA LED</b> Referencia 264 00 080	<b>STONE LED</b> Referencia 261 00 080	<b>FLASH</b> Referencia 340 11 070
---	--	--	---	--	---	--	--

## COMET\_80 (31.5")

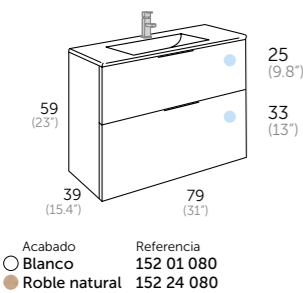

### ENCIMERA



**ALBA** cerámica  
Referencia  
510 01 080

Acabado Referencia  
○ Blanco 152 01 080  
● Roble natural 152 24 080

### ESPEJOS / mirrors / espelhos / miralls / ispiluak / espellos

### CAMERINO



<b>MOON</b> Referencia 200 00 080	<b>CLOUD</b> Referencia 205 00 080	<b>SIGMA</b> Referencia 290 00 080	<b>TOOL</b> Referencia ○ 207 01 080 ● 207 24 080	<b>RAIN LED</b> Referencia 269 00 080	<b>VERONA LED</b> Referencia 246 00 100	<b>HOLMES LED</b> Referencia 263 00 080	<b>SPOTY LED</b> Referencia 267 00 080	<b>FLASH</b> Referencia 340 11 080
---	--	--	---	---	---	---	--	--

## AUXILIARES / auxiliary units / auxiliares / auxiliars / osagarriak / auxiliares

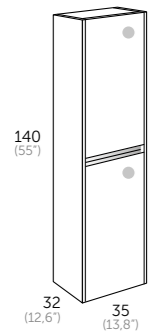

**JOKER** columna  
Acabado Referencia  
○ Blanco 137 01 335  
● Roble natural 137 24 335

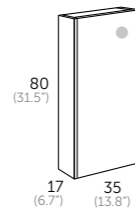

**JOKER** colgar  
Acabado Referencia  
○ Blanco 137 01 435  
● Roble natural 137 24 435

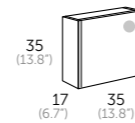

**JOKER** auxiliar  
Acabado Referencia  
○ Blanco 137 01 445  
● Roble natural 137 24 445



**Válvula universal CLIC CLAC**  
Referencia  
51601

## APLIQUES / spotlights / apliques / aplics / ezarkinak / apliques



<b>EVA LED</b> Referencia 400 00 011	<b>NEREA mate LED</b> Referencia 400 14 161 luz fría	<b>ESTHER LED</b> Referencia 400 00 121 luz fría 400 00 221 luz cálida	<b>SOFIA LED</b> Referencia 400 00 141 luz fría 400 00 241 luz cálida	<b>AINHOA LED</b> Referencia 400 00 151 luz fría	<b>NIKITA LED</b> Referencia 400 01 171 luz fría	<b>NAYRA LED</b> Referencia 400 00 181 luz fría
--	---	---	--	---	---	--

# Tívoli

\_80/100

fondo reducido

Sigma  
Omega  
Landes  
Landes modular  
Strip  
Cairo  
Dúo  
Ikaro  
Denim  
Lip  
Wave  
Sky  
Trent  
Escorpio  
Tauro  
Wood  
Mar  
Hole  
Aries  
Galsaky  
Small  
Homy  
Comet  
**Tívoli\_**  
Moon  
Dominó



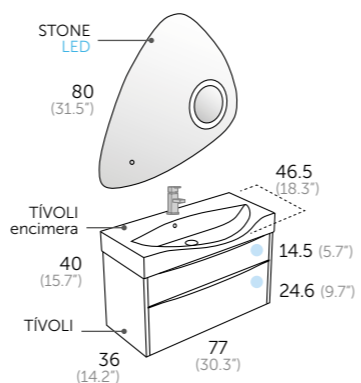

Composición **TÍVOLI 80 (31.5")**

- 1 113 01 080 TÍVOLI 80
- 1 513 01 080 TÍVOLI encimera
- 1 261 00 080 STONE LED

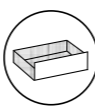

Interior cajones acabado textil  
*Interior of drawer textile finish*  
Interiores gaveta em acabamento t xtil  
*Interior calaix en acabat t xtil*  
Ehun-bukaerazko barnekaldedun kajoia  
*Interior do caix n en acabado textil*



Caj n con cierre amortiguado  
*Drawer fitted with soft closing system*  
Gaveta com sistema de corredeiras com amortecedor  
*Calaixos amb sistema de tancament suau*  
Motelgailudun itxierazko kajoia  
*Caix n con peche amortecido*

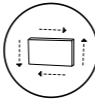

Fronte caj n regulable  
*Adjustable front drawer*  
Fronte da gaveta ajust vel  
*Frontal calaix regulable*  
Neurrirako kajoj aurrekaldea  
*Fronte do caix n axustable*



Gu as Hettich  
*Hettich drawer sliding system*  
Gu as Hettich  
*Guies Hettich*  
Hettich gidak  
*Gu as Hettich*



Acabado melamina con textura  
*Textured melamine finish*  
Cor melamina con textura  
*Acabat melamina amb textura*  
Texturadun melamina bukatua  
*Acabado melamina con textura*

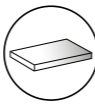

Acabado lacado brillo  
*High gloss lacquered finish*  
Cor lacado brilho  
*Acabat lacat brillant*  
Distiradun lakatzuko bukatua  
*Acabado lacado brillo*



Sistema antivaho  
*Anti fog system*  
Sistema anti-vapor  
*Sistema anti-ba*  
Lurrunaren kontrako sistema  
*Sistema antivaho*



Sensor de contacto On/ Off  
*Contact sensor On/ Off*  
Sensor interruptor On/ Off  
*Sensor de contacte On/ Off*  
On/Off kontaktu sentsorea  
*Sensor de contacto On/ Off*



Lupa aumento x3  
*Magnifying zoom in Mirror*  
Lupa aumento 3x  
*Lupa augment x3*  
3x-eko haundiagotze lupa  
*Lupa aumento x3*

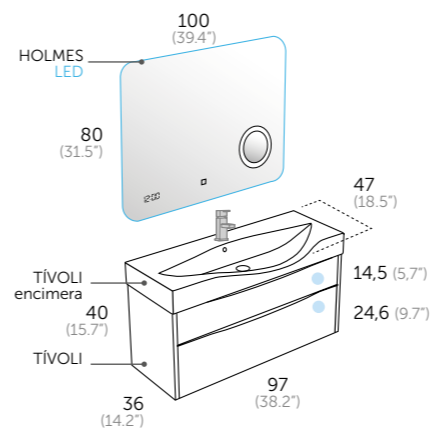
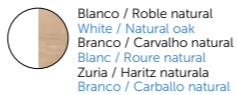

Composición **TÍVOLI 100 (39.4")**

- 1 113 24 100 TÍVOLI 100
- 1 513 01 100 TÍVOLI encimera
- 1 263 00 100 HOLMES LED



Sistema antivaho  
*Anti fog system*  
Sistema anti-vapor  
*Sistema anti-baf*  
Lurrunaren kontrako sistema  
*Sistema antivaho*



Sensor de contacto On/ Off  
*Contact sensor On/ Off*  
Sensor interruptor On/ Off  
*Sensor de contacte On/ Off*  
On/Off kontaktu sentsorea  
*Sensor de contacto On/ Off*



Reloj digital  
*Digital clock*  
Relogio digital  
*Rellotge digital*  
Erlotju digitala  
*Reloxo dixital*



Lupa aumento x3  
*Magnifying zoom in Mirror*  
Lupa aumento 3x  
*Lupa augment x3*  
3x-eko haundiagotze lupa  
*Lupa aumento x3*

## TÍVOLI\_80 (31.5")

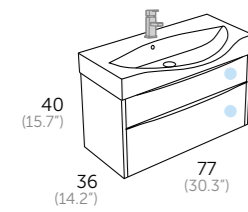

- Acabado Referencia
- Blanco 113 01 080
  - Blanco Roble natural 113 24 080

### ENCIMERA

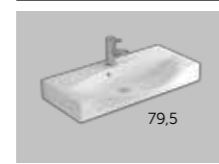

**TÍVOLI** cerámica  
Referencia  
513 01 080

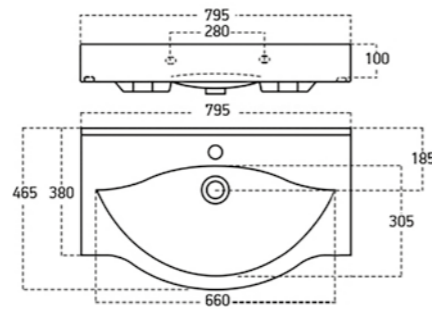

## TÍVOLI\_100 (39.4")

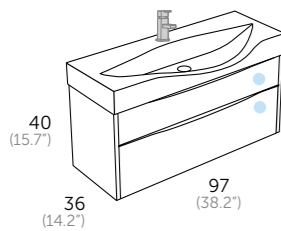

- Acabado Referencia
- Blanco 113 01 100
  - Blanco Roble natural 113 24 100

### ENCIMERA



**TÍVOLI** cerámica  
Referencia  
513 01 100

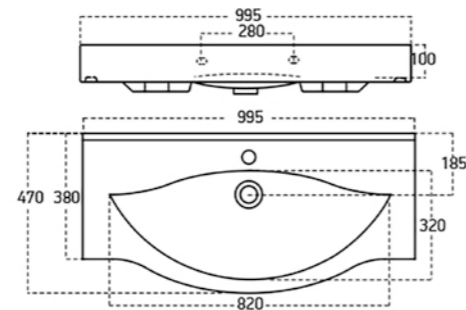

## ESPEJOS / mirrors / espelhos / miralls / ispihuak / espellos

### CAMERINO



## ESPEJOS / mirrors / espelhos / miralls / ispihuak / espellos

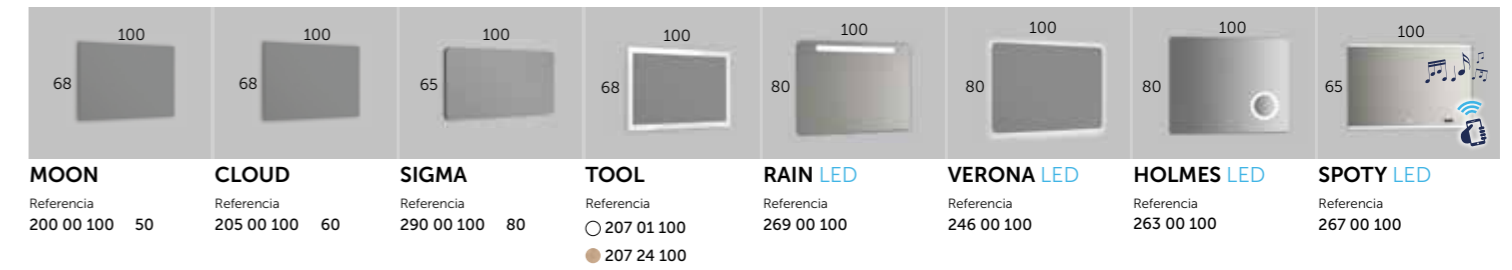

## AUXILIARES / auxiliary units / auxiliares / auxiliars / osagarriak / auxiliares

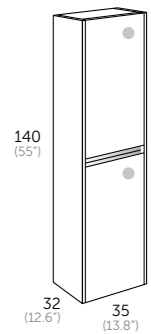

**JOKER** columna  
Acabado Referencia  
○ Blanco 137 01 335  
● Roble natural 137 24 335

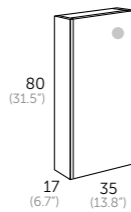

**JOKER** colgar  
Acabado Referencia  
○ Blanco 137 01 435  
● Roble natural 137 24 435

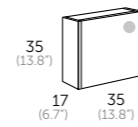

**JOKER** auxiliar  
Acabado Referencia  
○ Blanco 137 01 445  
● Roble natural 137 24 445



**Válvula universal CLIC CLAC**  
Referencia  
51601

## APLIQUES / spotlights / apliques / aplics / ezarkinak / apliques

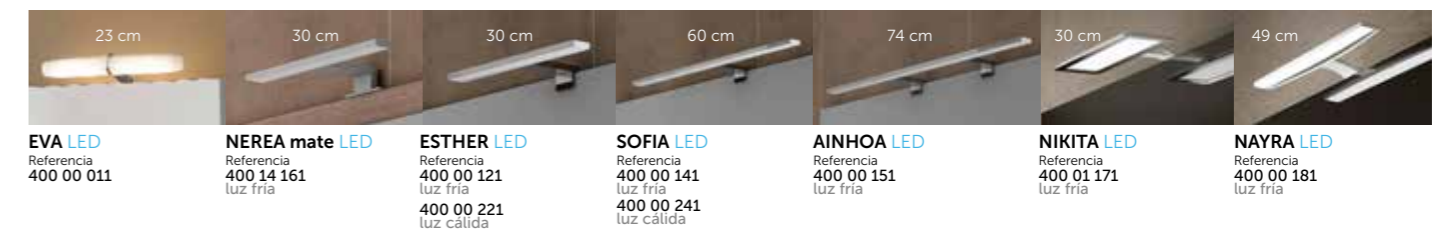

# Moon<sup>\_50</sup>

fondo reducido

- Sigma
- Omega
- Landes
- Landes modular
- Strip
- Cairo
- Dúo
- Ikaro
- Denim
- Lip
- Wave
- Sky
- Trent
- Escorpio
- Tauro
- Wood
- Mar
- Hole
- Aries
- Galsaky
- Small
- Homy
- Comet
- Tivoli
- Moon\_**
- Dominó



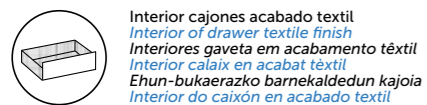

Interior cajones acabado textil  
*Interior of drawer textile finish*  
 Interiores gaveta em acabamento têxtil  
*Interior calaix en acabat tèxtil*  
 Ehun-bukaeazko barnekaldeudun kajoia  
*Interior do caixón en acabado têxtil*

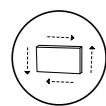

Frente cajón regulable  
*Adjustable front drawer*  
 Frente da gaveta ajustável  
*Frontal calaix regulable*  
 Neurrirako kajoj aurrekaldea  
*Fronte do caixón axustable*

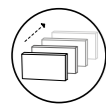

Cajón con cierre amortiguado  
*Drawer fitted with soft closing system*  
 Gaveta com sistema de correções com amortecedor  
 Calaixos amb sistema de tancament suau  
 Motelgailudun itxierazko kajoia  
*Caixón con peche amortecido*

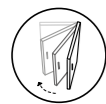

Puerta con cierre amortiguado  
*Door with soft closing system*  
 Porta com amortecedor  
 Porta amb sistema de tancament suau  
 Motelgailudun itxierazko atea  
*Porta con peche amortecido*

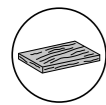

Acabado melamina con textura  
*Textured melamine finish*  
 Cor melamina com textura  
 Acabat melamina amb textura  
 Testuradun melanina bukatua  
*Acabado melanina con textura*



Guías Hettich  
*Hettich drawer sliding system*  
 Guias Hettich  
 Guias Hettich  
 Hettich gidak  
 Guias Hettich

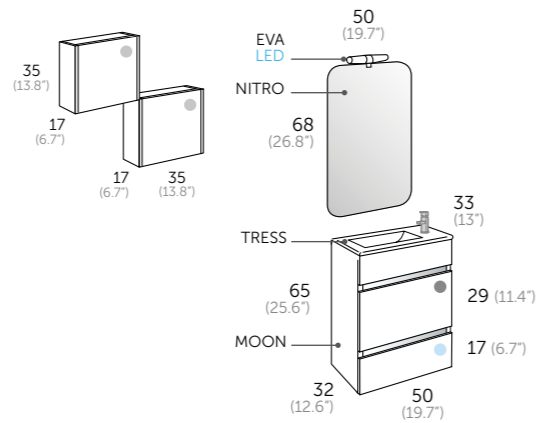

### Composición **MOON 50** (20")

- 1 154 21 050 MOON 50
- 1 529 01 050 TRESS
- 1 241 00 050 NITRO
- 1 400 00 011 EVA LED

### Auxiliares

- 2 135 21 445 JOKER axul.



- Blanco White Branco Blanc Zuria Branco
- Roble medio Medium oak Carvalho médio Roure mitja Haritz ertainekoa Carballo medio

## MOON\_50 (20")

ESPEJOS Y CAMERINOS más opciones en págs. 316 - 325

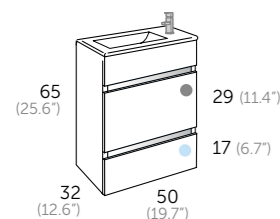

- Acabado Referencia
- Blanco 154 01 050
  - Roble medio 154 21 050



### ENCIMERA



**TRESS**  
 Referencia 529 01 050

### ESPEJOS

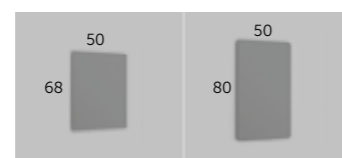

**MOON**  
 Referencia 200 00 050

**NITRO**  
 Referencia 241 00 050

### APLIQUES

más opciones en pág. 326



**EVA LED**  
 Referencia 400 00 011

**NEREA mate LED**  
 Referencia 400 14 161  
 luz fría

**ESTHER LED**  
 Referencia 400 00 121  
 luz fría  
 Referencia 400 00 221  
 luz cálida

## AUXILIARES / auxiliary units / auxiliares / auxiliars / osagarriak / auxiliares

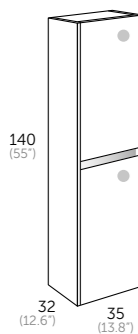

### JOKER columna

- Acabado Referencia
- Blanco 137 01 335
  - Roble medio 137 21 335

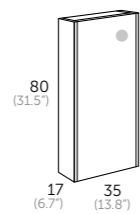

### JOKER colgar

- Acabado Referencia
- Blanco 137 01 435
  - Roble medio 137 21 435

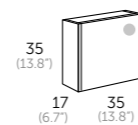

### JOKER auxiliar

- Acabado Referencia
- Blanco 137 01 445
  - Roble medio 137 21 445



### Válvula universal CLIC CLAC

Referencia 51601

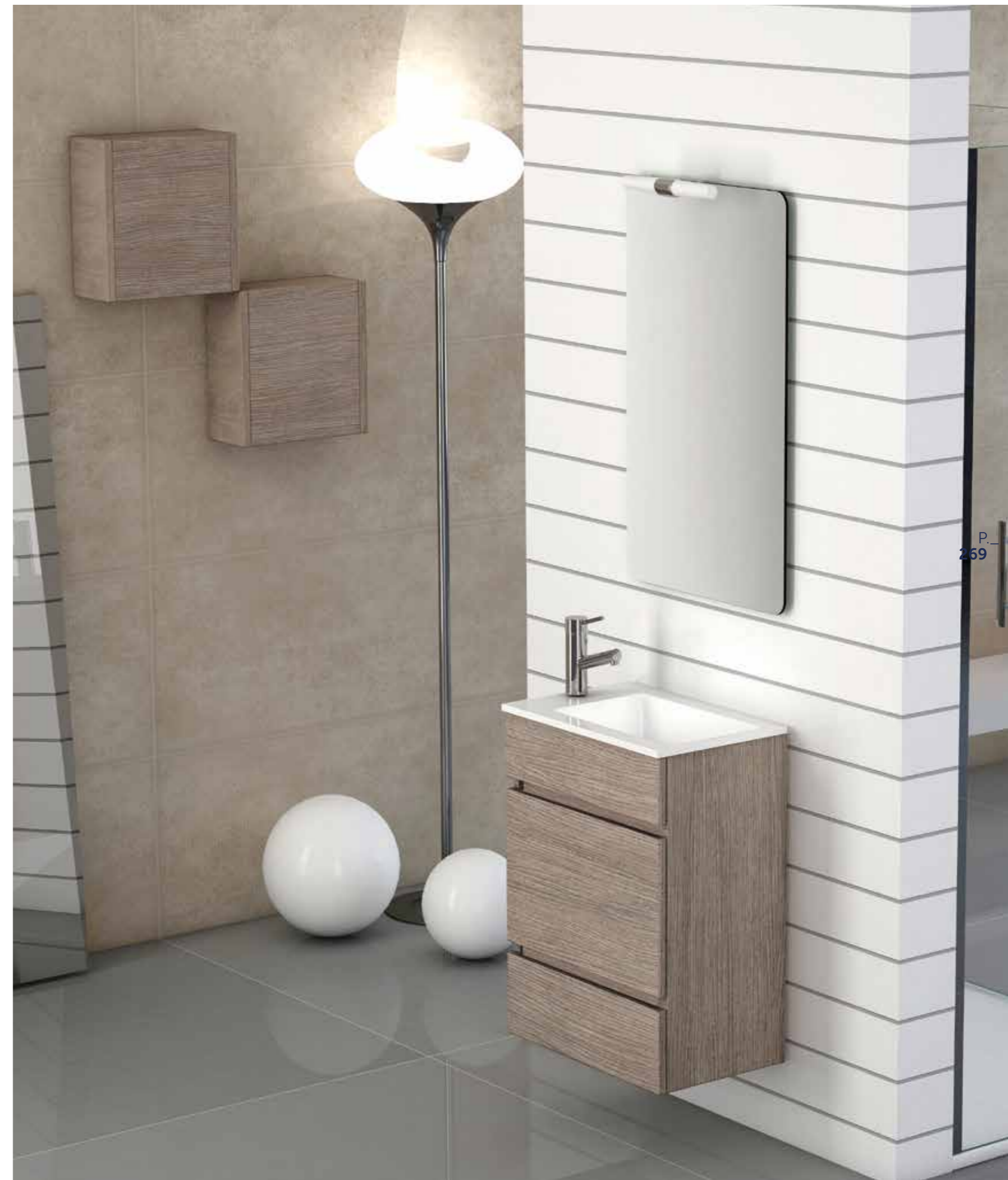



# Dominó<sup>\_40</sup>

\_P.  
270



Sigma  
Omega  
Landes  
Landes modular  
Strip  
Cairo  
Dúo  
Ikaro  
Denim  
Lip  
Wave  
Sky  
Trent  
Escorpio  
Tauro  
Wood  
Mar  
Hole  
Aries  
Galsaky  
Small  
Homy  
Comet  
Tívoli  
Moon  
**Dominó\_**



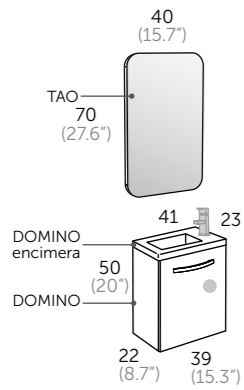

Composición **DOMINÓ 40**

- 1 128 01 040 DOMINÓ 40
- 1 528 01 040 DOMINÓ encimera
- 1 240 00 040 TAO

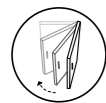

**Puerta con cierre amortiguado**  
*Door with soft closing system*  
*Porta com amortecedor*  
*Porta amb sistema de tancament suau*  
*Motelgailudun itxierazko atea*  
*Porta con peche amortecido*

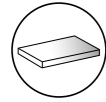

**Acabado lacado brillo**  
*High gloss lacquered finish*  
*Cor lacado brilho*  
*Acabat lacat brillant*  
*Distiradun lakatuzko bukatua*  
*Acabado lacado brillo*

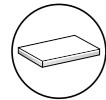

**Frente con canto efecto cristal**  
*Front with edge crystal effect*  
*Frente com canto efeito vidro*  
*Frontal amb cantell efecte vidre*  
*Kristal efektudun ertzezko aurrekaldea*  
*Fronte con canto efecto cristal*



**DOMINÓ\_40**

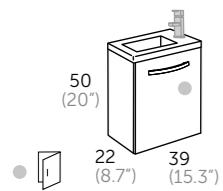

- Acabado Referencia
- Blanco 128 01 040
  - Gris 128 03 040
  - Negro 128 02 040

**ENCIMERA**



**DOMINÓ**  
Referencia  
528 01 040

**ESPEJO**

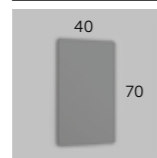

**TAO**  
Referencia  
240 00 040

**CAMERINO**



**DOMINÓ**  
Referencia  
Blanco 328 01 040  
Aluminio 328 14 040



# Especificaciones técnicas

Technical specifications

Especificações técnicas

Especificacions tècniques

Espezifikazio teknikoak

Especificacións técnicas

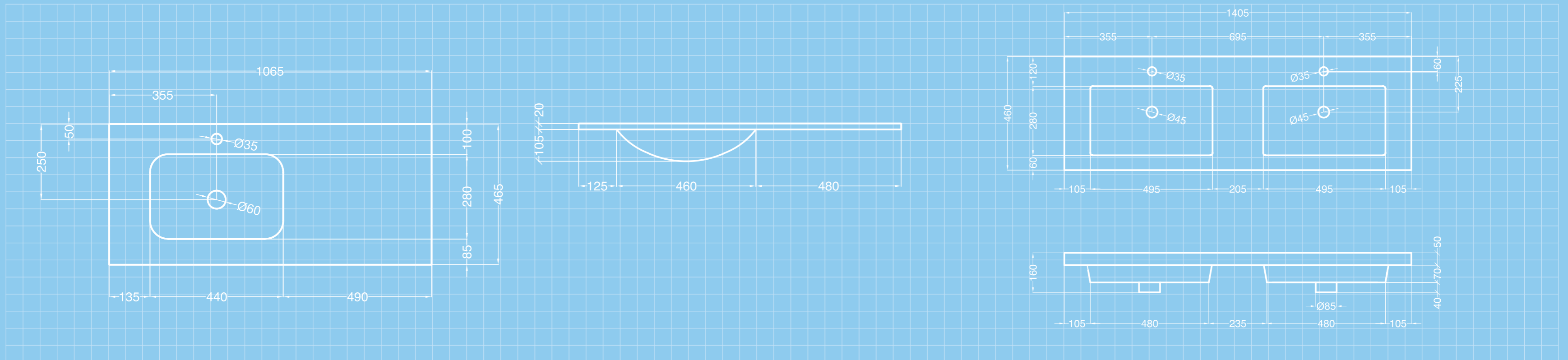
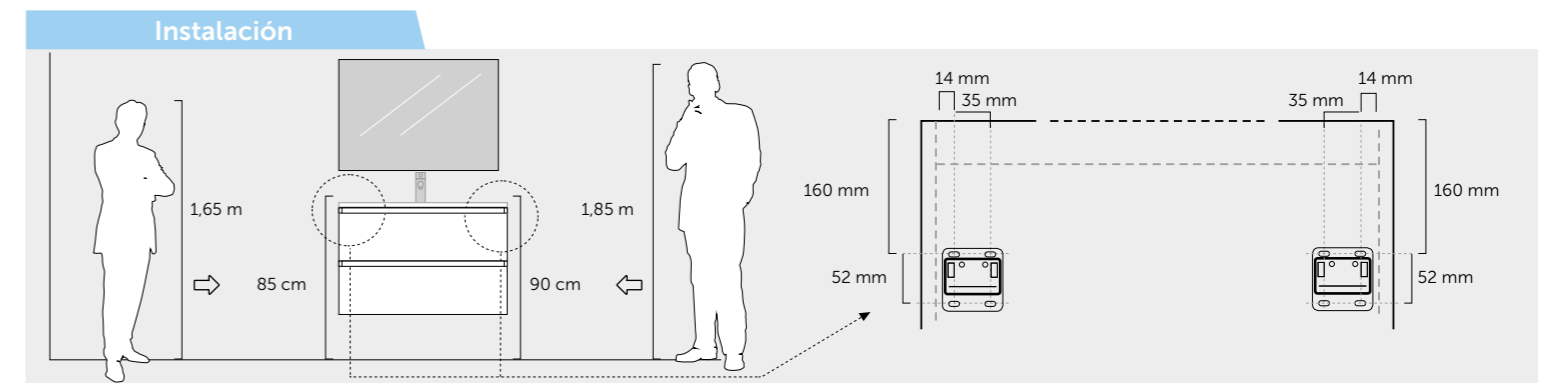

# SIGMA



- Blanco mate  
Matte white  
Branco mate  
Blanc mat  
Zuri matea  
Branco mate
- Gris  
Grey  
Cinzentu  
Gris  
Grisa  
Gris
- Roble natural  
Natural oak  
Carvalho natural  
Roure natural  
Haritz naturala  
Carballo natural

## Descripción:

- Mueble suspendido en estructura de 19 mm de grueso. Material hidrófugo.
- Sujeción ajustable en altura y profundidad con sistema antivuelco.
- 1 cajón grande de costillas metálicas ajustable con extracción y cierre amortiguado.
- Estructura reforzada con marco de metal.

- Fronte de 19 mm, tirador invisible.
- Lacado mate.
- Incluye un sifón extraplano.

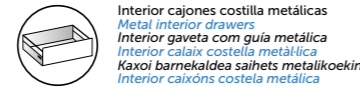
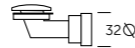

Interior cajones costilla metálicas  
Metal interior drawers  
Interior gaveta com guia metálica  
Interior calaix costella metàlica  
Kaxoi barnekaldea saihets metalikoekin  
Interior caixons costela metàlica

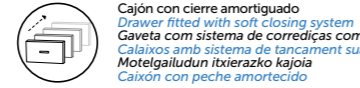

Cajón con cierre amortiguado  
Drawer fitted with soft closing system  
Gaveta com sistema de corredeiras com amortecedor  
Calaixos amb sistema de tancament suau  
Motelgailudun itxierazko kajoia  
Caixon con peche amortecido



Guías Grass  
Grass drawer sliding system  
Guia Grass  
Guies Grass  
Grass gidak  
Guias Grass



Guías Hettich  
Hettich drawer sliding system  
Guia Hettich  
Guies Hettich  
Hettich gidak  
Guias Hettich

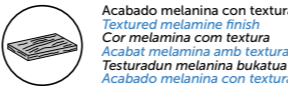

Acabado melanina con textura  
Textured melamine finish  
Cor melanina com textura  
Acabat melamina amb textura  
Testuradun melanina bukatua  
Acabado melanina con textura

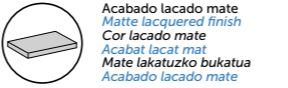

Acabado lacado mate  
Matte lacquered finish  
Cor lacado mat  
Acabat lacat mat  
Mate lakatzeko bukatua  
Acabado lacado mate

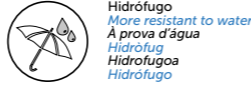

Hidrófugo  
More resistant to water  
À prova d'água  
Hidrofulgu  
Hidrofulgoa  
Hidrofulguo

## SIGMA 80

Acabado	Referencia
Blanco mate	190 01 080
Gris intenso mate	190 34 080
Roble natural	190 24 080

## SIGMA 105

Acabado	Referencia
Blanco mate	190 01 105
Gris intenso mate	190 34 105
Roble natural	190 24 105

## SIGMA 120

Acabado	Referencia
Blanco mate	190 01 120
Gris intenso mate	190 34 120
Roble natural	190 24 120

## SIGMA 140

Acabado	Referencia
Blanco mate	190 01 140
Gris intenso mate	190 34 140
Roble natural	190 24 140

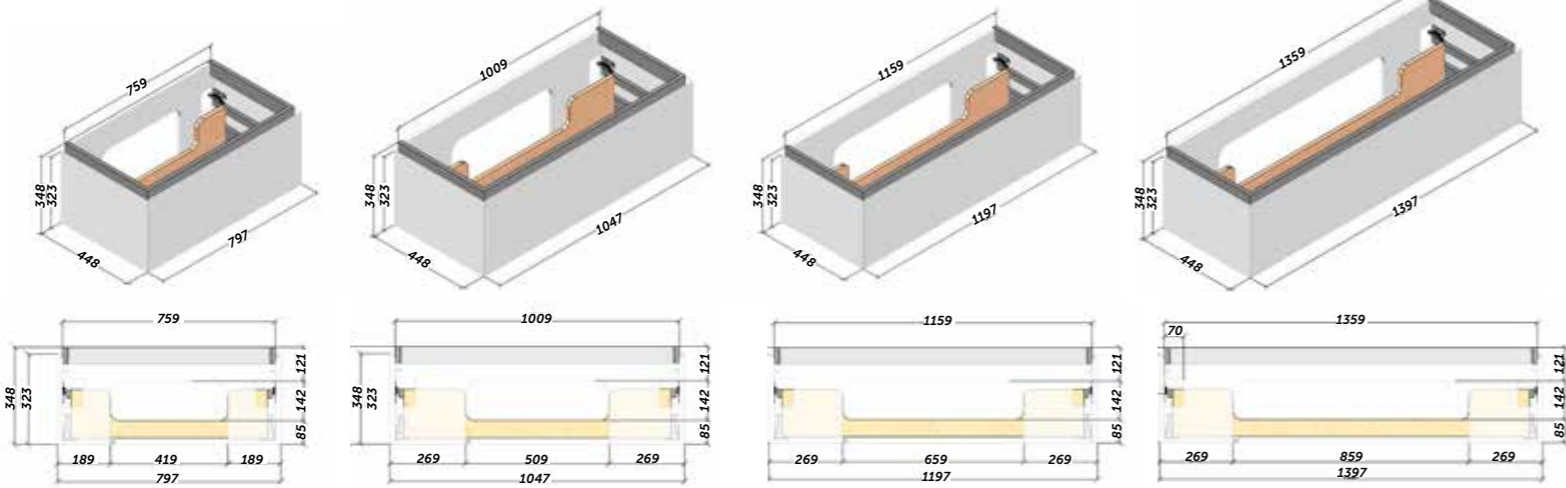

## AUXILIARES / auxiliary units / auxiliares / auxiliars / osagarriak / auxiliares

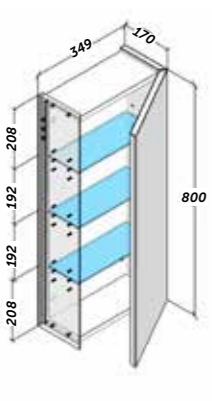

### SIGMA colgar

Acabado	Referencia
Blanco mate	190 01 435
Gris intenso mate	190 34 435
Roble natural	190 24 435

El estante de cristal puede cambiar de posición +/- 32 mm



Puerta con cierre amortiguado  
Door with soft closing system  
Porta com amortecedor  
Porta amb sistema de tancament suau  
Motelgailudun itxierazko atea  
Porta con peche amortecido

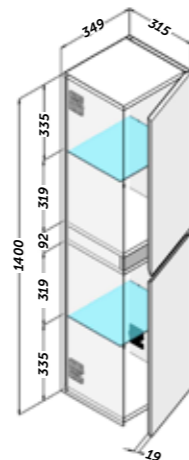

### SIGMA columna

Acabado	Referencia
Blanco mate	190 01 340
Gris intenso mate	190 34 340
Roble natural	190 24 340

El estante de cristal puede cambiar de posición +/- 64 mm



Puerta con cierre amortiguado  
Door with soft closing system  
Porta com amortecedor  
Porta amb sistema de tancament suau  
Motelgailudun itxierazko atea  
Porta con peche amortecido

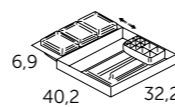

### organizador

Referencia  
411 00 001

# OMEGA



- Blanco mate  
Matte white  
Branco mate  
Blanc mat  
Zuri matea  
Branco mate
- Gris  
Grey  
Cinzentu  
Gris  
Grisa  
Gris
- Moka  
Mink  
Moka  
Moka  
Moka  
Moka

## Descripción:

- Mueble suspendido en estructura de 19 mm de grueso. Material hidrófugo.
- Sujeción ajustable en altura y profundidad con sistema antivuelco.
- 2 cajones de costillas metálicas ajustables con extracción y cierre amortiguado.
- Fronte de 19 mm, esquinas redondeadas, tirador integrado.
- Lacado brillo

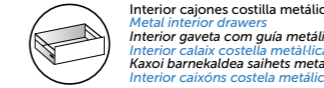

Interior cajones costilla metálicas  
Metal interior drawers  
Interior gaveta com guia metálica  
Interior calaix costella metàlica  
Kaxoi barnekaldea saihets metalikoekin  
Interior caixons costela metàlica

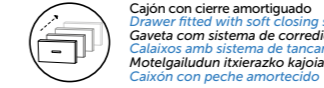

Cajón con cierre amortiguado  
Drawer fitted with soft closing system  
Gaveta com sistema de corredeiras com amortecedor  
Calaixos amb sistema de tancament suau  
Motelgailudun itxierazko kajoia  
Caixon con peche amortecido



Guías Hettich  
Hettich drawer sliding system  
Guia Hettich  
Guies Hettich  
Hettich gidak  
Guias Hettich

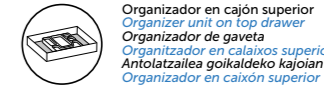

Organizador en cajón superior  
Organizer unit on top drawer  
Organizador de gaveta  
Organizador en calaixos superiors  
Antolatzalea goialdeko kajoian  
Organizador en caixon superior

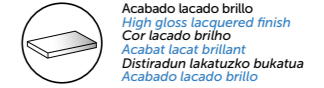

Acabado lacado brillo  
High gloss lacquered finish  
Cor lacado brilho  
Acabat lacat brillant  
Distiradun lakatzeko bukatua  
Acabado lacado brillo

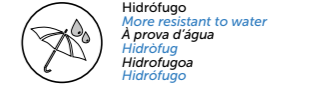

Hidrófugo  
More resistant to water  
À prova d'água  
Hidrofulgu  
Hidrofulgoa  
Hidrofulguo

## OMEGA 80

Acabado	Referencia
Blanco	193 01 080
Gris	193 03 080
Moka	193 16 080

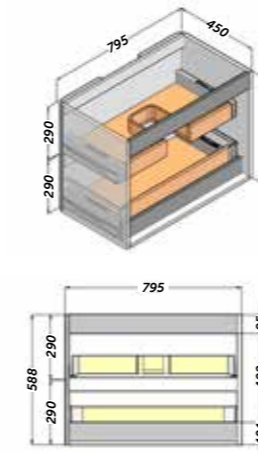

## OMEGA 100

Acabado	Referencia
Blanco	193 01 100
Gris	193 03 100
Moka	193 16 100

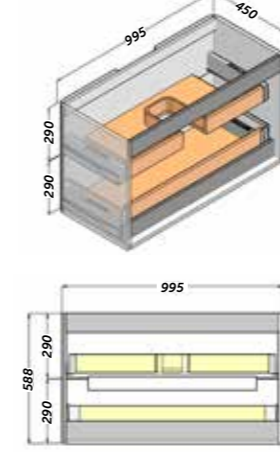

## OMEGA 120

Acabado	Referencia
Blanco	193 01 120
Gris	193 03 120
Moka	193 16 120

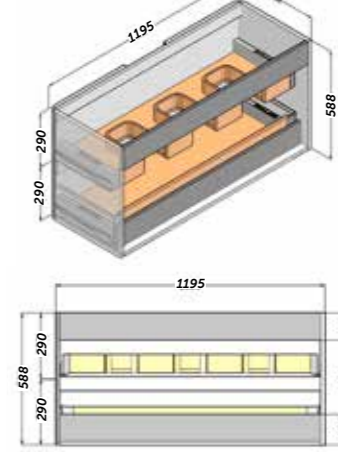

## AUXILIARES / auxiliary units / auxiliares / auxiliars / osagarriak / auxiliares



### OMEGA columna

Acabado	Referencia
Blanco	193 01 335
Gris	193 03 335
Moka	193 16 335

El estante de cristal puede cambiar de posición +/- 64 mm



Puerta con cierre amortiguado  
Door with soft closing system  
Porta com amortecedor  
Porta amb sistema de tancament suau  
Motelgailudun itxierazko atea  
Porta con peche amortecido

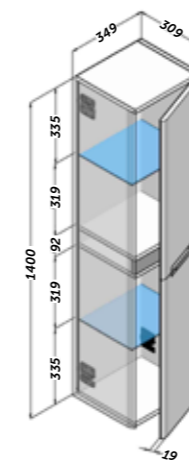

# LANDES



MADE IN SPAIN

## Descripción:

- Mueble suspendido en estructura 19 mm de grueso. Material hidrófugo.
- Sujeción ajustable en altura y profundidad con sistema antivuelco.
- 2 cajones de costillas metálicas ajustables con extracción y cierre amortiguado
- Frentes de 19 mm.
- Tiradores de aluminio.
- Costados chapados en laser.
- Fabricado en material hidrófugo.
- Tiradores en color aluminio para los acabados Blanco mate y Roble Natural.
- Tiradores en el mismo color del mueble para los acabados en Moka y Gris.



Interior cajones costilla metálicas  
Metal interior drawers  
Interior gaveta con guía metálica  
Interior calaix costella metàlica  
Kaxoi barnekaldea saihets metalikoeikin  
Interior calaixons costela metàlica



Cajón con cierre amortiguado  
Drawer fitted with soft closing system  
Gaveta com sistema de correduças com amortecedor  
Calaixos amb sistema de tancament suau  
Motelgailudun itxierazko kajoia  
Caiixon con peche amortecido



Guías Hettich  
Hettich drawer sliding system  
Guías Hettich  
Guias Hettich  
Hettich gidak  
Guias Hettich



Organizador en cajón superior  
Organizer unit on top drawer  
Organizador de gaveta  
Organizador en calaixos superiors  
Antolatzailea goikaldeko kajoian  
Organizador en caixon superior



Puerta con cierre amortiguado  
Door with soft closing system  
Porta com amortecedor  
Porta amb sistema de tancament suau  
Motelgailudun itxierazko atea  
Porta con peche amortecido



Acabado lacado brillo  
High gloss lacquered finish  
Cor lacado briho  
Acabat lacat brillant  
Distiradun lakatzuko bukatua  
Acabado lacado brillo



Acabado melamina con textura  
Textured melamine finish  
Cor melamina con textura  
Acabat melamina amb textura  
Testuradun melamina bukatua  
Acabado melamina con textura



Hidrófugo  
More resistant to water  
À prova d'água  
Hidrofug  
Hidrofugoa  
Hidrofugo

- Blanco mate  
Matte white  
Branco mate  
Blanc mat  
Zuri matea  
Branco mate
- Gris  
Grey  
Cinzento  
Gris  
Grisa  
Gris
- Roble natural  
Natural oak  
Carvalho natural  
Roure natural  
Haritz naturala  
Carballo natural
- Moka  
Mink  
Moka  
Moka  
Moka  
Moka



## LANDES 60

Acabado	Referencia
Blanco mate	112 35 060
Roble natural	112 24 060
Gris	112 03 060
Moka	112 16 060

## LANDES 80

Acabado	Referencia
Blanco mate	112 35 080
Roble natural	112 24 080
Gris	112 03 080
Moka	112 16 080

## LANDES 90

Acabado	Referencia
Blanco mate	112 35 090
Roble natural	112 24 090
Gris	112 03 090
Moka	112 16 090

## LANDES 100

Acabado	Referencia
Blanco mate	112 35 100
Roble natural	112 24 100
Gris	112 03 100
Moka	112 16 100

## LANDES 120

Acabado	Referencia
Blanco mate	112 35 120
Roble natural	112 24 120
Gris	112 03 120
Moka	112 16 120

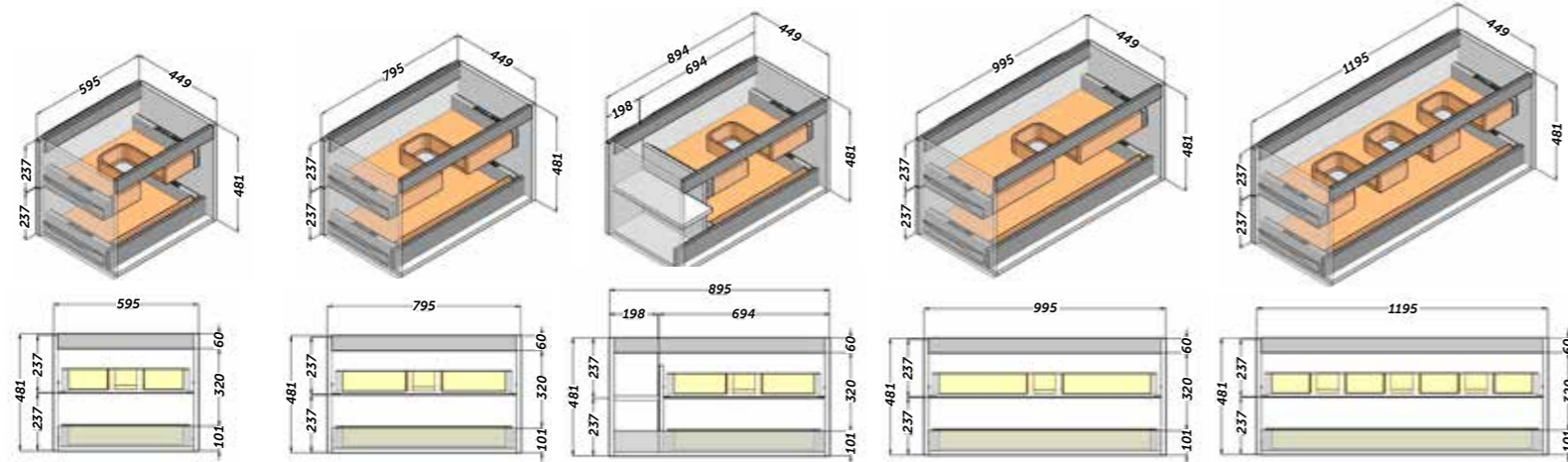

## AUXILIARES / auxiliary units / auxiliares / auxiliars / osagarriak / auxiliares

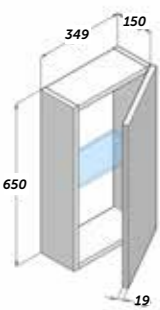

### LANDES colgar

Acabado	Referencia
Blanco mate	112 35 435
Roble natural	112 24 435
Gris	112 03 435
Moka	112 16 435

El estante de cristal puede cambiar de posición +/- 32 mm



Puerta con apertura push  
Door with push to open  
Porta abertura com push  
Porta amb obertura push  
Push irekieradun atea  
Porta con apertura push

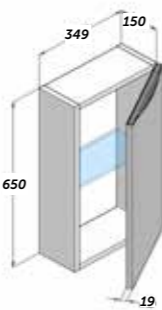

### LANDES bajo columna izda.

Acabado	Referencia
Blanco mate	112 35 036
Roble natural	112 24 036
Gris	112 03 036
Moka	112 16 036

El estante de cristal puede cambiar de posición +/- 32 mm



Puerta con cierre amortiguado  
Door with soft closing system  
Porta com amortecedor  
Porta amb sistema de tancament suau  
Motelgailudun itxierazko atea  
Porta con peche amortecido

### LANDES bajo columna dcha.

Acabado	Referencia
Blanco mate	112 35 035
Roble natural	112 24 035
Gris	112 03 035
Moka	112 16 035

# LANDES modular



MADE IN SPAIN

## Descripción:

- Mueble suspendido en estructura 19 mm de grueso.
- Sujeción ajustable en altura y profundidad con sistema antivuelco.
- 2 cajones de costillas metálicas ajustables con extracción y cierre amortiguado.
- Frentes de 19 mm.
- Tiradores de aluminio.
- Costados chapados en laser.
- Fabricado en material hidrófugo.



Interior cajones costilla metálicas  
Metal interior drawers  
Interior gaveta con guía metálica  
Interior calaix costella metàlica  
Kaxoi barnekaldea saihets metalikoeikin  
Interior calaixons costela metàlica



Cajón con cierre amortiguado  
Drawer fitted with soft closing system  
Gaveta com sistema de correduças com amortecedor  
Calaixos amb sistema de tancament suau  
Motelgailudun itxierazko kajoia  
Caiixon con peche amortecido



Guías Hettich  
Hettich drawer sliding system  
Guías Hettich  
Guias Hettich  
Hettich gidak  
Guias Hettich



Organizador en cajón superior  
Organizer unit on top drawer  
Organizador de gaveta  
Organizador en calaixos superiors  
Antolatzailea goikaldeko kajoian  
Organizador en caixon superior



Puerta con cierre amortiguado  
Door with soft closing system  
Porta com amortecedor  
Porta amb sistema de tancament suau  
Motelgailudun itxierazko atea  
Porta con peche amortecido



Acabado melamina con textura  
Textured melamine finish  
Cor melamina con textura  
Acabat melamina amb textura  
Testuradun melamina bukatua  
Acabado melamina con textura



Hidrófugo  
More resistant to water  
À prova d'água  
Hidrofug  
Hidrofugoa  
Hidrofugo

- Blanco mate  
Matte white  
Branco mate  
Blanc mat  
Zuri matea  
Branco mate
- Roble natural  
Natural oak  
Carvalho natural  
Roure natural  
Haritz naturala  
Carballo natural

## LANDES 60

sin salvafón

Acabado	Referencia
Blanco mate	112 35 061
Roble natural	112 24 061

## LANDES 80

sin salvafón

Acabado	Referencia
Blanco mate	112 35 081
Roble natural	112 24 081

## LANDES 100

sin salvafón

Acabado	Referencia
Blanco mate	112 35 101
Roble natural	112 24 101

## LANDES 120

sin salvafón

Acabado	Referencia
Blanco mate	112 35 121
Roble natural	112 24 121

## MÓDULOS

### Módulo estante 20

Acabado	Referencia
Blanco mate	112 35 022
Roble natural	112 24 022

### Módulo 20 izda.

Acabado	Referencia
Blanco mate	112 35 021
Roble natural	112 24 021

### Módulo 30 izda.

Acabado	Referencia
Blanco mate	112 35 031
Roble natural	112 24 031

### Módulo 40 izda.

Acabado	Referencia
Blanco mate	112 35 041
Roble natural	112 24 041

### Módulo 50 izda.

Acabado	Referencia
Blanco mate	112 35 051
Roble natural	112 24 051

### Módulo estante a medida

Acabado	Referencia
Blanco mate	112 35 000
Roble natural	112 24 000

### Módulo 20 dcha.

Acabado	Referencia
Blanco mate	112 35 020
Roble natural	112 24 020

### Módulo 30 dcha.

Acabado	Referencia
Blanco mate	112 35 030
Roble natural	112 24 030

### Módulo 40 dcha.

Acabado	Referencia
Blanco mate	112 35 040
Roble natural	112 24 040

### Módulo 50 dcha.

Acabado	Referencia
Blanco mate	112 35 050
Roble natural	112 24 050

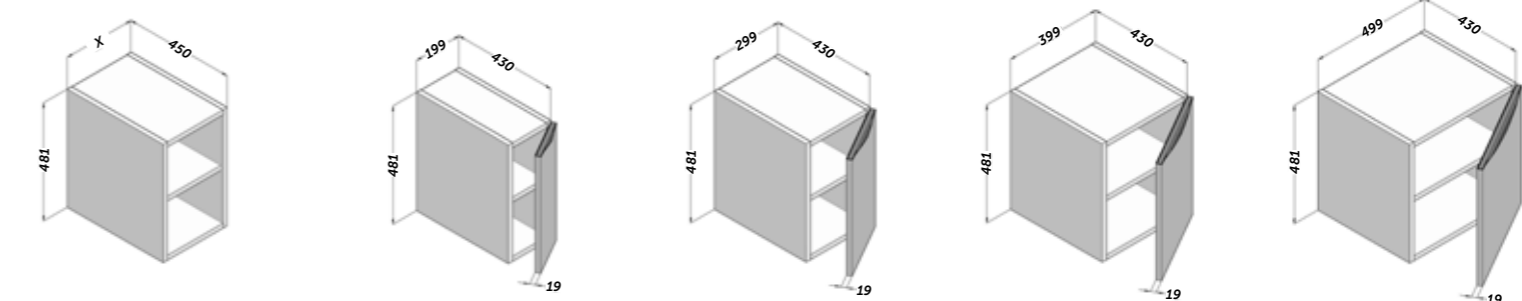

## TAPA LANDES

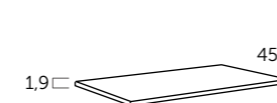

Fabricadas en MDF hidrófugo y chapadas con laser.  
Las tapas se sirven sin agujero.

		Blanco mate		Roble natural	
Medida	Referencia	Medida	Referencia	Medida	Referencia
60 x 45	112 35 206	60 x 45	112 24 206		
80 x 45	112 35 208	80 x 45	112 24 208		
90 x 45	112 35 209	90 x 45	112 24 209		
100 x 45	112 35 210	100 x 45	112 24 210		
110 x 45	112 35 211	110 x 45	112 24 211		
120 x 45	112 35 212	120 x 45	112 24 212		
130 x 45	112 35 213	130 x 45	112 24 213		
140 x 45	112 35 214	140 x 45	112 24 214		
150 x 45	112 35 215	150 x 45	112 24 215		
160 x 45	112 35 216	160 x 45	112 24 216		
180 x 45	112 35 218	180 x 45	112 24 218		
200 x 45	112 35 220	200 x 45	112 24 220		
x cm lineal	112 35 999	x cm lineal	112 24 999		

# STRIP



## Descripción:

- Mueble suspendido en estructura de 16 mm de grueso acabado efecto mate.
- Sujeción ajustable en altura y profundidad con sistema antivuelco.
- 1 cajón grande de costillas metálicas ajustable con extracción y cierre amortiguado.
- 1 cajón interior con sistema de acceso directo.



Interior cajones costilla metálicas  
Metal interior drawers  
Interior gaveta con guía metálica  
Interior calaix costella metàlica  
Kaxoi barnekaldea saihets metalikoekin  
Interior caixons costela metàlica



Guías Grass  
Grass drawer sliding system  
Guía Grass  
Guias Grass  
Grass gidak  
Guias Grass



Cajón con cierre amortiguado  
Drawer fitted with soft closing system  
Gaveta com sistema de corredeiras com amortecedor  
Calaixos amb sistema de tancament suau  
Motelgailudun itxierazko kajoia  
Caixon con peche amortecido



Acabado lacado mate  
Matte lacquered finish  
Cor lacado mate  
Acabat lacat mat  
Mate lakatzuko bukatua  
Acabado lacado mate

- Gris suave mate  
Matte light grey  
Cinzeno suave mate  
Gris suau mat  
Gris mate leuna  
Gris suave mate
- Gris intenso mate  
Matte dark grey  
Cinzeno intenso mate  
Gris intens mat  
Gris mate bizia  
Gris intenso mate

# CAIRO



## Descripción:

- Mueble suspendido en estructura 16 mm de grueso.
- Sujeción ajustable en altura y profundidad con sistema antivuelco.
- 2 cajones de costillas metálicas ajustables con extracción y cierre amortiguado.
- Frontes de 22 mm con tirador integrado.



Interior cajones costilla metálicas  
Metal interior drawers  
Interior gaveta com guia metálica  
Interior calaix costella metàlica  
Kaxoi barnekaldea saihets metalikoekin  
Interior caixons costela metàlica



Guías Hettich  
Hettich drawer sliding system  
Guías Hettich  
Guias Hettich  
Hettich gidak  
Guias Hettich



Cajón con cierre amortiguado  
Drawer fitted with soft closing system  
Gaveta com sistema de corredeiras com amortecedor  
Calaixos amb sistema de tancament suau  
Motelgailudun itxierazko kajoia  
Caixon con peche amortecido



Acabado melamina con textura  
Textured melamine finish  
Cor melamina con textura  
Acabat melamina amb textura  
Testuradun melamina bukatua  
Acabado melamina con textura



Acabado lacado brillo  
High gloss lacquered finish  
Cor lacado brillo  
Acabat lacat brillant  
Distiradun lakatzuko bukatua  
Acabado lacado brillo

- Blanco  
White  
Branco  
Blanc  
Zuria  
Branco
- Roble natural  
Natural oak  
Carvalho natural  
Roure natural  
Haritz naturala  
Carballo natural
- Pino gris  
Grey pine  
Pinho cinzento  
Pi gris  
Pinu grisa  
Piñeiro gris
- Nogal oscuro  
Dark walnut  
Nogueira escuro  
Nogueira fosca  
Intxaurrenondo iluna  
Nogueira escura

## STRIP 80

Acabado	Referencia
Gris suave mate	191 33 080
Gris intenso mate	191 34 080

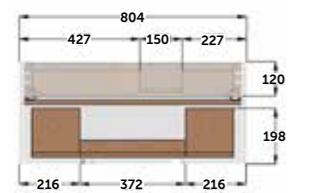
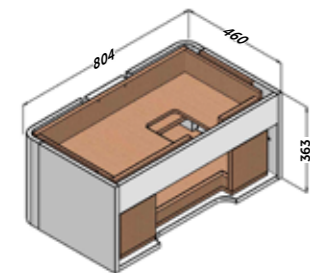

## STRIP 100

Acabado	Referencia
Gris suave mate	191 33 120
Gris intenso mate	191 34 120

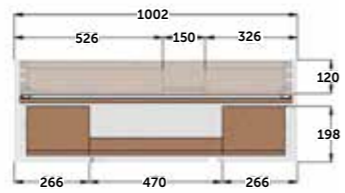
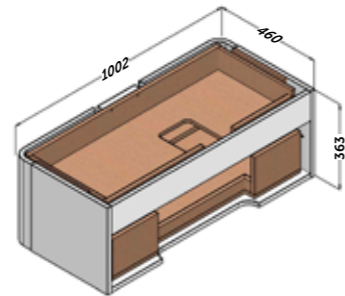

## STRIP 120

Acabado	Referencia
Gris suave mate	191 33 120
Gris intenso mate	191 34 120

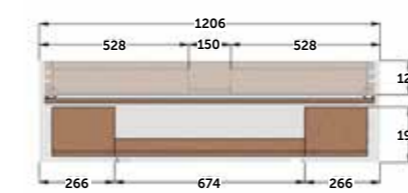
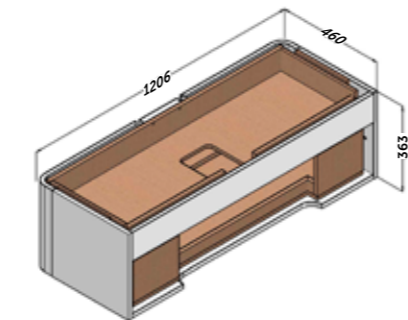

## CAIRO 80

Acabado	Referencia
Blanco	194 01 080
Roble natural	194 24 080
Pino gris	194 37 080
Nogal oscuro	194 39 080

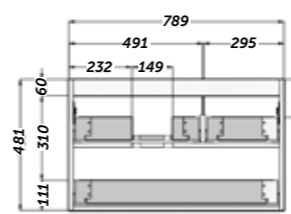
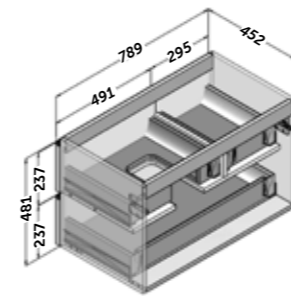

## CAIRO 100

Acabado	Referencia
Blanco	194 01 100
Roble natural	194 24 100
Pino gris	194 37 100
Nogal oscuro	194 39 100

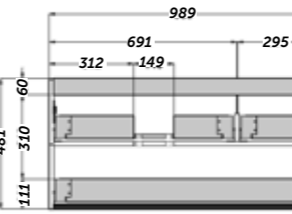
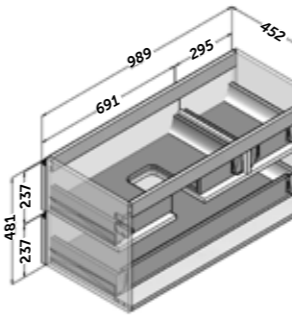

## AUXILIARES / auxiliary units / auxiliares / auxiliars / osagarriak / auxiliares



## AUXILIARES / auxiliary units / auxiliares / auxiliars / osagarriak / auxiliares

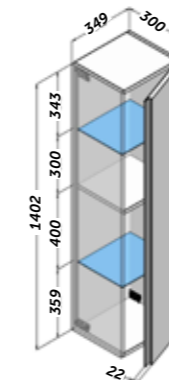

### CAIRO columna

Acabado	Referencia
Blanco	194 01 335
Roble natural	194 24 335
Pino gris	194 37 335
Nogal oscuro	194 39 335

El estante de cristal puede cambiar de posición +/- 64 mm



Puerta con cierre amortiguado  
Door with soft closing system  
Porta com amortecedor  
Porta amb sistema de tancament suau  
Motelgailudun itxierazko atea  
Porta con peche amortecido

# DÚO



### Descripción:

- Mueble suspendido en estructura de 19 mm de grueso.
- Sujeción ajustable en altura y profundidad con sistema antivuelco.
- 1 cajón de costillas metálicas ajustable con extracción y cierre amortiguado.
- Frente de 19 mm con laterales PVC efecto cristal.
- Tirador largo transversal metal cromado.



Interior cajones costilla metálicas  
Metal interior drawers  
Interior gaveta con guía metálica  
Interior caixa costella metálica  
Kaxoi barnekaldea saihets metalikoekin  
Interior caixóns costela metálica



Acabado melamina con textura  
Textured melamine finish  
Cor melamina con textura  
Acabat melamina amb textura  
Testuradun melamina bukatua  
Acabado melamina con textura



Cajón con cierre amortiguado  
Drawer fitted with soft closing system  
Gaveta com sistema de corredejas com amortecedor  
Caixóns amb sistema de tancament suau  
Motelgailudun itxierazko kajoia  
Caixon con peche amortecido



Frente con canto efecto cristal  
Front with edge crystal effect  
Frente com canto efeito vidro  
Frontal amb cantell efecte vidre  
Kristal efektudun ertzezko aurrekaldea  
Fronte con canto efecto cristal



Acabado lacado brillo  
High gloss lacquered finish  
Cor lacado brillo  
Acabat lacat brillant  
Distiradun lakatzeko bukatua  
Acabado lacado brillo

- |                           |                          |                                 |   |
|---------------------------|--------------------------|---------------------------------|---|
| Blanco<br>White<br>Branco | Gris<br>Grey<br>Cinzento | Negro<br>Black<br>Petro         | Roble medio<br>Medium oak<br>Carvalho médio         |
| Blanc<br>Zuria<br>Branco  | Gris<br>Gris<br>Gris     | Negro<br>Zuri-beltzean<br>Negro | Roure mitja<br>Haritz ertainekoak<br>Carballo medio |

## DÚO 70 con salvasifón

Acabado	Referencia
Blanco	101 01 070
Gris	101 03 070
Negro	101 02 070
Roble medio	101 21 070

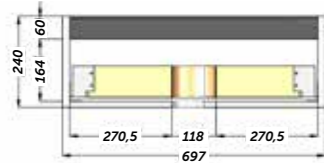
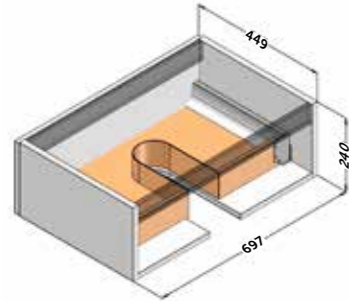

## DÚO 70 sin salvasifón

Acabado	Referencia
Blanco	101 01 071
Gris	101 03 071
Negro	101 02 071
Roble medio	101 21 071

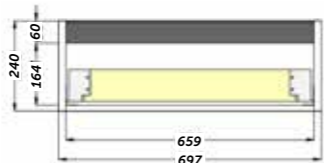
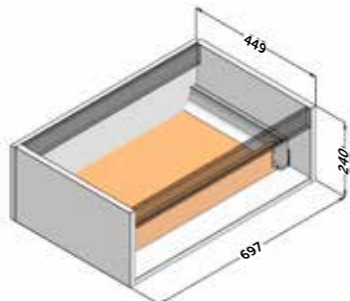

## DÚO 35

Acabado	Referencia
Blanco	101 01 035
Gris	101 03 035
Negro	101 02 035
Roble medio	101 21 035

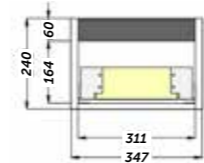
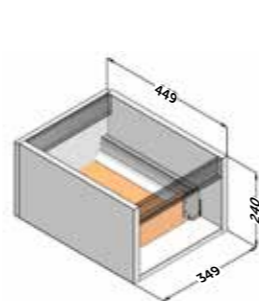

## AUXILIARES/

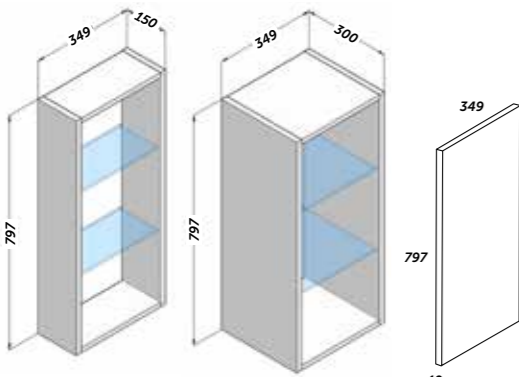

### DÚO colgar FONDO 15

Acabado	Referencia
Blanco	101 01 435
Gris	101 03 435
Negro	101 02 435
Roble medio	101 21 435

### DÚO colgar FONDO 30

Acabado	Referencia
Blanco	101 01 436
Gris	101 03 436
Negro	101 02 436
Roble medio	101 21 436

### DÚO puerta colgar

Acabado	Referencia
Blanco	101 01 535
Gris	101 03 535
Negro	101 02 535
Roble medio	101 21 535
Mirror	101 00 535

## TAPA DÚO

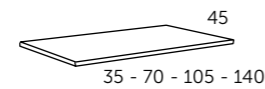

### TAPA 35

Acabado	Referencia
Blanco	101 01 203
Gris	101 03 203
Negro	101 02 203
Roble medio	101 21 203

### TAPA 70

Acabado	Referencia
Blanco	101 01 207
Gris	101 03 207
Negro	101 02 207
Roble medio	101 21 207

### TAPA 105

Acabado	Referencia
Blanco	101 01 210
Gris	101 03 210
Negro	101 02 210
Roble medio	101 21 210

### TAPA 140

Acabado	Referencia
Blanco	101 01 214
Gris	101 03 214
Negro	101 02 214
Roble medio	101 21 214

### Patas (juegos de 4)

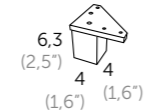

Referencia
412 00 050

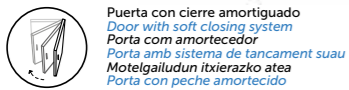

Puerta con cierre amortiguado  
Door with soft closing system  
Porta com amortecedor  
Porta amb sistema de tancament suau  
Motelgailudun itxierazko atea  
Porta con peche amortecido

El estante de cristal puede cambiar de posición +/- 32 mm

# IKARO



### Descripción:

- Mueble suspendido en estructura de 16 mm de grueso.
- Sujeción ajustable en altura y profundidad con sistema antivuelco.
- 2 cajones grandes de costillas metálicas ajustables con extracción y cierre amortiguado
- Frentes de 19 mm.
- Lacado brillo.



Interior cajones costilla metálicas  
Metal interior drawers  
Interior gaveta com guia metálica  
Interior caixa costella metálica  
Kaxoi barnekaldea saihets metalikoekin  
Interior caixóns costela metálica



Acabado lacado brillo  
High gloss lacquered finish  
Cor lacado brillo  
Acabat lacat brillant  
Distiradun lakatzeko bukatua  
Acabado lacado brillo



Cajón con cierre amortiguado  
Drawer fitted with soft closing system  
Gaveta com sistema de corredejas com amortecedor  
Caixóns amb sistema de tancament suau  
Motelgailudun itxierazko kajoia  
Caixon con peche amortecido

- |                           |                          |
|---------------------------|--------------------------|
| Blanco<br>White<br>Branco | Gris<br>Grey<br>Cinzento |
| Blanc<br>Zuria<br>Branco  | Gris<br>Gris<br>Gris     |

## IKARO 60

Acabado	Referencia
Blanco	107 01 060
Gris	107 03 060

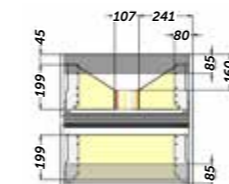
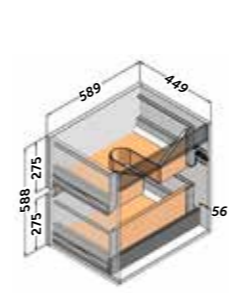

## IKARO 80

Acabado	Referencia
Blanco	107 01 080
Gris	107 03 080

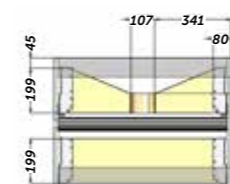
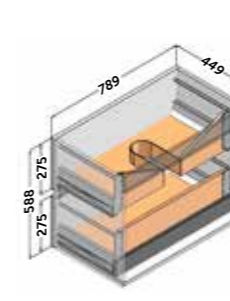

## IKARO 100

Acabado	Referencia
Blanco	107 01 100 345
Gris	107 03 100 345

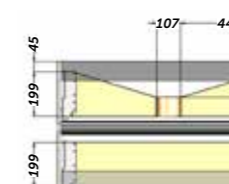
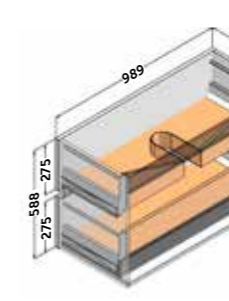

## IKARO 120

Acabado	Referencia
Blanco	107 01 120 392
Gris	107 03 120 392

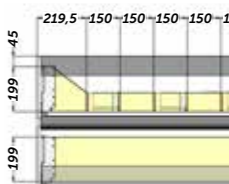
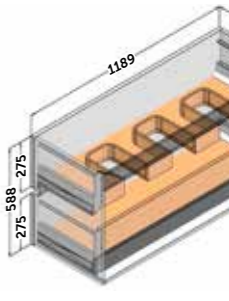

## AUXILIARES / auxiliary units / auxiliares / auxiliars / osagarriak / auxiliares

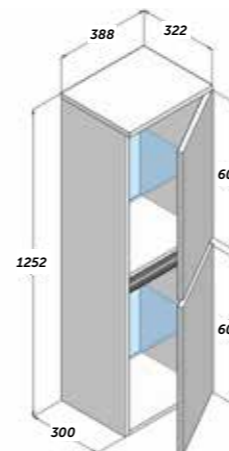

### IKARO columna

Acabado	Referencia
Blanco	107 01 338
Gris	107 03 338

El estante de cristal puede cambiar de posición +/- 64 mm



Puerta con cierre amortiguado  
Door with soft closing system  
Porta com amortecedor  
Porta amb sistema de tancament suau  
Motelgailudun itxierazko atea  
Porta con peche amortecido

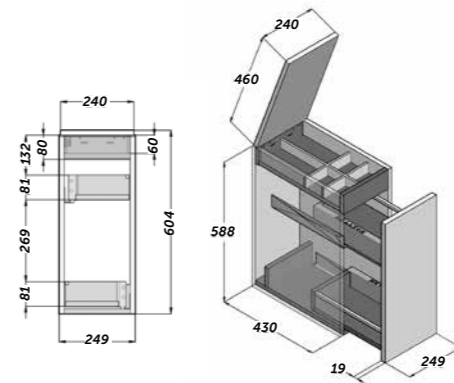

### LOOK

Acabado	Referencia
Blanco	107 01 024
Gris	107 03 024

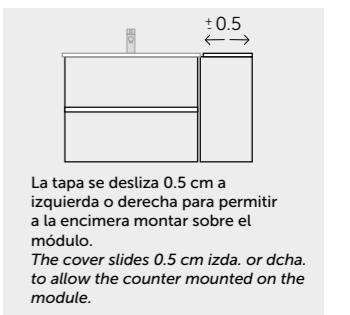

La tapa se desliza 0.5 cm a izquierda o derecha para permitir a la encimera montar sobre el módulo.  
The cover slides 0.5 cm izda. or dcha. to allow the counter mounted on the module.

# DENIM



## Descripción:

- Sujeción ajustable en altura y profundidad con sistema antivuelco.
- 2 cajones de costillas metálicas ajustables con extracción y cierre amortiguado (1 interior)
- Frontes de 25 mm con marco de refuerzo.



Interior cajones costilla metálicas  
Metal interior drawers  
Interior gaveta com guia metálica  
Interior caixa costella metálica  
Kaxoi barnealde saihets metalikoekin  
Interior caixons costella metálica



Acabado melamina con textura  
Textured melamine finish  
Cor melamina com textura  
Acabat melamina amb textura  
Testuradun melamina bukatua  
Acabado melamina con textura



Cajón con cierre amortiguado  
Drawer fitted with soft closing system  
Gaveta com sistema de corredeiras com amortecedor  
Calaixos amb sistema de tancament suau  
Motelgailudun itxierazko kajoia  
Caixón con peche amortecido



# LIP

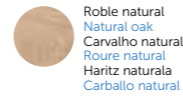

## Descripción encimera:

- 2 opciones de encimera: una opción en madera de 19 mm y otra en AMBAR solid surface.
- La encimera de madera para lavabos de sobreponer fabricada en material hidrófugo.
- La encimera AMBAR tiene 2 opciones:  
1) para lavabo sobreponer.  
2) con lavabo integrado.
- Sistema de soportes invisibles.



Interior cajones costilla metálicas  
Metal interior drawers  
Interior gaveta com guia metálica  
Interior caixa costella metálica  
Kaxoi barnealde saihets metalikoekin  
Interior caixons costella metálica



Guías Hettich  
Hettich drawer sliding system  
Guías Hettich  
Guies Hettich  
Hettich gidak  
Guies Hettich



Acabado melamina con textura  
Textured melamine finish  
Cor melamina com textura  
Acabat melamina amb textura  
Testuradun melamina bukatua  
Acabado melamina con textura



Cajón con cierre amortiguado  
Drawer fitted with soft closing system  
Gaveta com sistema de corredeiras com amortecedor  
Calaixos amb sistema de tancament suau  
Motelgailudun itxierazko kajoia  
Caixón con peche amortecido



Hidrófugo  
More resistant to water  
A prova d'aigua  
Hidrófug  
Hidrófugoa  
Hidrófugo



## DENIM 60

Acabado Referencia  
Vintage 111 26 060

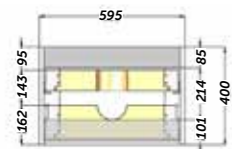
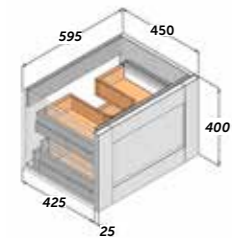

## DENIM 80

Acabado Referencia  
Vintage 111 26 080

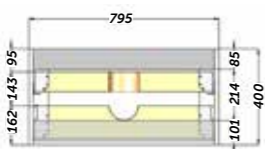
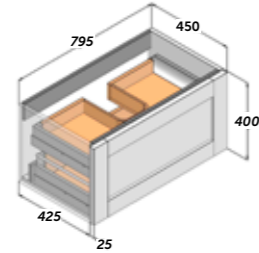

## DENIM 100

Acabado Referencia  
Vintage 111 26 100

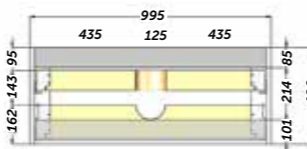
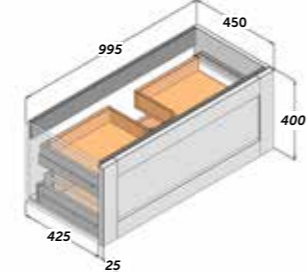

## DENIM 120

Acabado Referencia  
Vintage 111 26 120

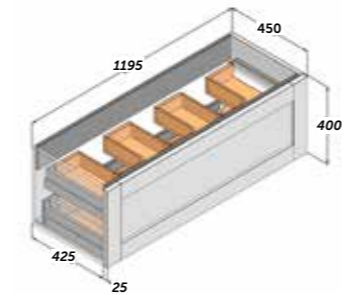

## AUXILIARES / auxiliary units / auxiliares / auxiliars / osagarriak / auxiliares

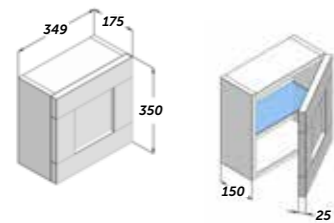

### DENIM auxiliar

Acabado Referencia  
Vintage 111 26 435

El estante de cristal puede cambiar de posición +/- 32 mm



Puerta con cierre amortiguado  
Door with soft closing system  
Porta com amortecedor  
Porta amb sistema de tancament suau  
Motelgailudun itxierazko atea  
Porta con peche amortecido

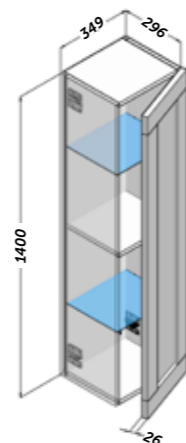

### DENIM columna

Acabado Referencia  
Vintage 111 26 335

El estante de cristal puede cambiar de posición +/- 64 mm



Puerta con cierre amortiguado  
Door with soft closing system  
Porta com amortecedor  
Porta amb sistema de tancament suau  
Motelgailudun itxierazko atea  
Porta con peche amortecido

## LIP 80

### LIP encimera

Acabado	Referencia
AMBAR LIP	524 01 081
AMBAR LIP Integrado	524 01 080
Roble natural	108 24 080

### LIP book

Blanco mate	108 35 208
Roble natural	108 24 208

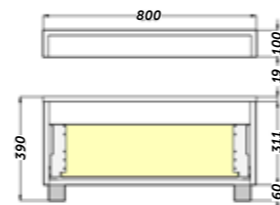
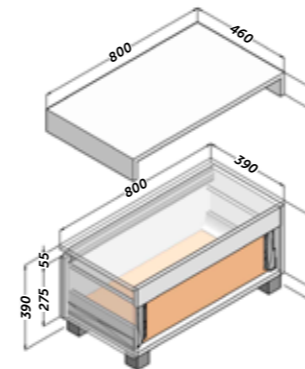

## LIP 100

### LIP encimera

Acabado	Referencia
AMBAR LIP	524 01 101
AMBAR LIP Integrado	524 01 100
Roble natural	108 24 100

### LIP book

Blanco mate	108 35 210
Roble natural	108 24 210

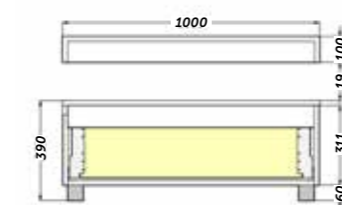
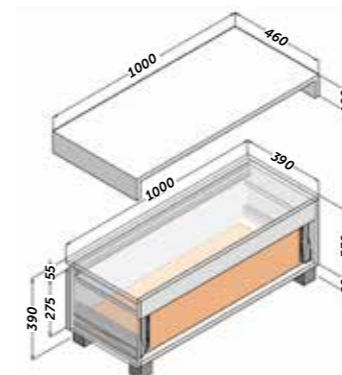

## LIP 120

### LIP encimera

Acabado	Referencia
AMBAR LIP	524 01 121
AMBAR LIP Integrado	524 01 120
Roble natural	108 24 120

### LIP book

Blanco mate	108 35 220
Roble natural	108 24 220

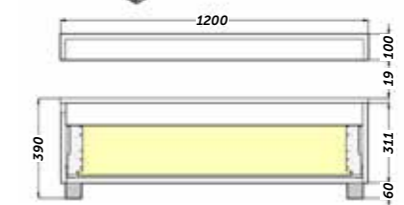
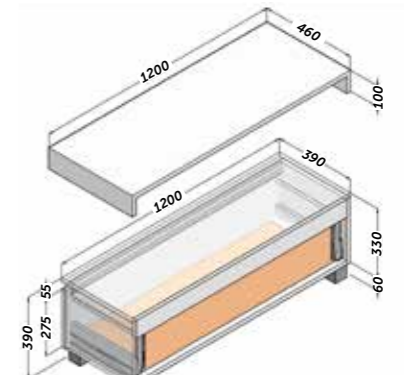

## Sistema de soportes invisibles

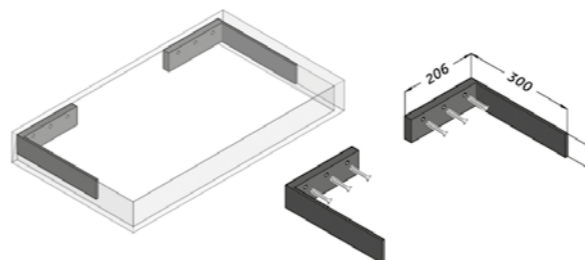

## toalleros



Toallero LIP  
para encimera de madera

Referencia  
cromo 416 00 002



Toallero integrado opcional  
para AMBAR LIP

Referencia  
524 01 999



# WAVE



## Descripción:

- Mueble suspendido en estructura de 16 mm de grueso.
- Sujeción ajustable en altura y profundidad con sistema antivuelco.
- 1 cajón de costillas metálicas ajustables con extracción y cierre amortiguado.
- Frentes curvos de 19 mm.
- Lacado brillo.



Interior cajones costilla metálicas  
Metal interior drawers  
Interior gaveta com guia metálica  
Interior calaix costella metálica  
Kaxoi barnekaldea saihets metalikoekin  
Interior caixóns costela metálica



Acabado lacado brillo  
High gloss lacquered finish  
Cor lacado briho  
Acabat lacat brillant  
Distiradun lakatzuko bukatur  
Acabado lacado brillo



Cajón con cierre amortiguado  
Drawer fitted with soft closing system  
Gaveta com sistema de correções com amortecedor  
Calaixos amb sistema de tancament suau  
Motelgailudun itxierazko kajoia  
Caixón con peche amortecido



Acabado lacado brillo  
High gloss lacquered finish  
Cor lacado briho  
Acabat lacat brillant  
Distiradun lakatzuko bukatur  
Acabado lacado brillo



Puerta con cierre amortiguado  
Door with soft closing system  
Porta com amortecedor  
Porta amb sistema de tancament suau  
Motelgailudun itxierazko atea  
Porta con peche amortecido

Blanco  
White  
Branco  
Blanc  
Zurita  
Branco

## WAVE 60

Acabado Referencia  
Blanco 116 01 060

## WAVE 80

Acabado Referencia  
Blanco 116 01 080

## WAVE 100

Acabado Referencia  
Blanco 116 01 100

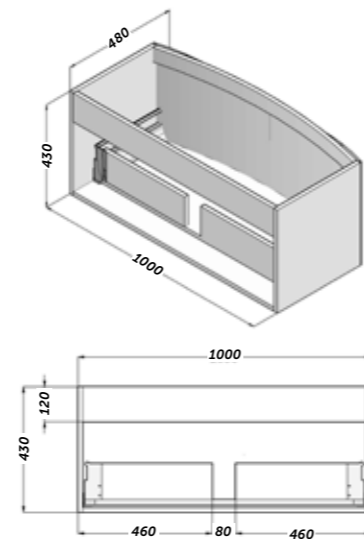
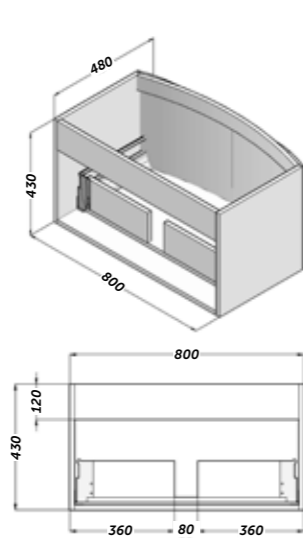
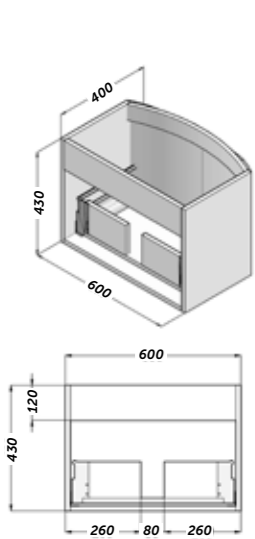

# SKY



## Descripción:

- Mueble suspendido en estructura 16 mm de grueso.
- Sujeción ajustable en altura y profundidad con sistema antivuelco.
- Cajón de costillas metálicas ajustables con extracción y cierre amortiguado.
- Puerta con cierre amortiguado.
- Lacado brillo.



Interior cajones costilla metálicas  
Metal interior drawers  
Interior gaveta com guia metálica  
Interior calaix costella metálica  
Kaxoi barnekaldea saihets metalikoekin  
Interior caixóns costela metálica



Acabado lacado brillo  
High gloss lacquered finish  
Cor lacado briho  
Acabat lacat brillant  
Distiradun lakatzuko bukatur  
Acabado lacado brillo



Cajón con cierre amortiguado  
Drawer fitted with soft closing system  
Gaveta com sistema de correções com amortecedor  
Calaixos amb sistema de tancament suau  
Motelgailudun itxierazko kajoia  
Caixón con peche amortecido



Puerta con cierre amortiguado  
Door with soft closing system  
Porta com amortecedor  
Porta amb sistema de tancament suau  
Motelgailudun itxierazko atea  
Porta con peche amortecido

Blanco  
White  
Branco  
Blanc  
Zurita  
Branco

## SKY 60

Acabado Referencia  
Blanco 117 01 060

## SKY 80

Acabado Referencia  
Blanco 117 01 080

## SKY 100

Acabado Referencia  
Blanco 117 01 100

## SKY 120

Acabado Referencia  
Blanco 117 01 120

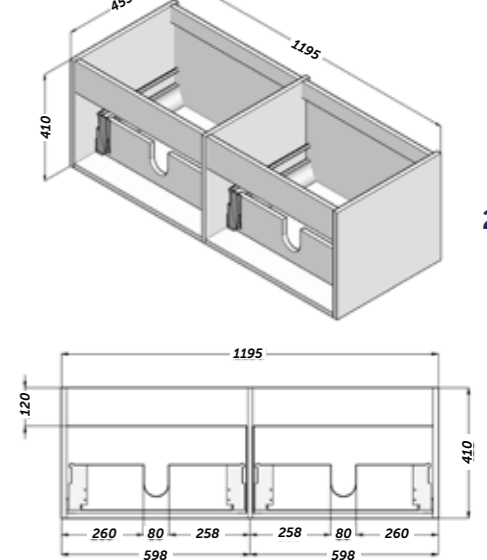
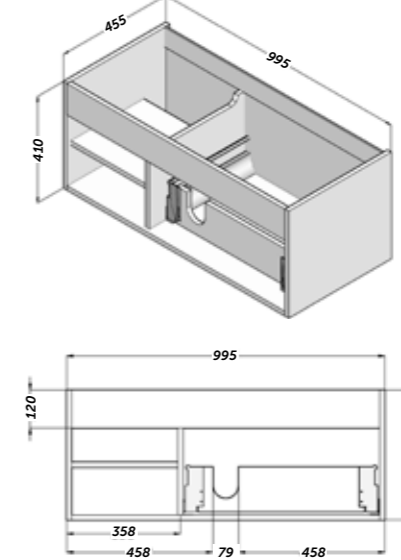
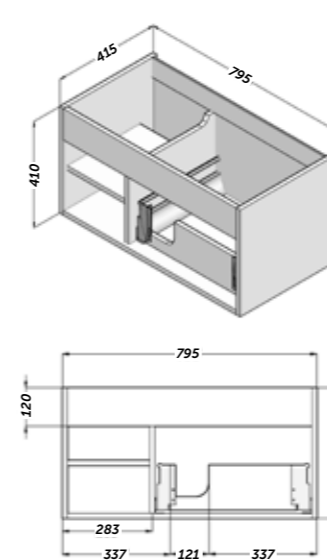
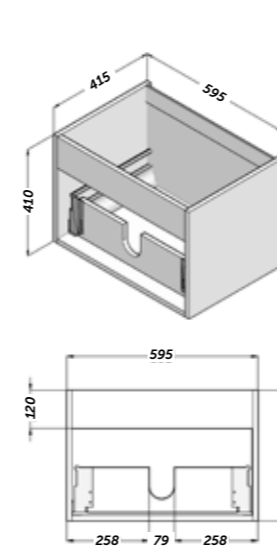

# TRENT



MADE IN SPAIN

## Descripción:

- 2 cajones de costillas metálicas ajustables con extracción y cierre amortiguado.
- Frentes de 19 mm.
- Patas ABS efecto cromado.
- Costados con patas y marco de 40 mm.
- Frentes de 19 mm con marcos.



Interior cajones costilla metálicas  
Metal interior drawers  
Interior gaveta com guia metálica  
Interior caixa costela metálica  
Kaxoi barnealde saihets metalikoekin  
Interior caixóns costela metálica



Acabado lacado mate  
Matte lacquered finish  
Cor lacado mate  
Acabat lacat mat  
Mate lakatzuko bukatua  
Acabado lacado mate



Cajón con cierre amortiguado  
Drawer fitted with soft closing system  
Gaveta com sistema de corredeiras com amortecedor  
Caixaos amb sistema de tancament suau  
Motelgailudun itxierazko kajoia  
Caixón con peche amortecido

- |   |  |
|---|--|
| ○ Blanco mate<br>Matte white<br>Branco mate<br>Blanc mat<br>Zuri matea<br>Branco mate | ● Gris mate<br>Matte grey<br>Cinzentto mate<br>Gris mat<br>Gris matea<br>Gris mate |
|---|--|



## TRENT 80

Acabado	Referencia
Blanco mate	195 01 080
Gris mate	195 03 080

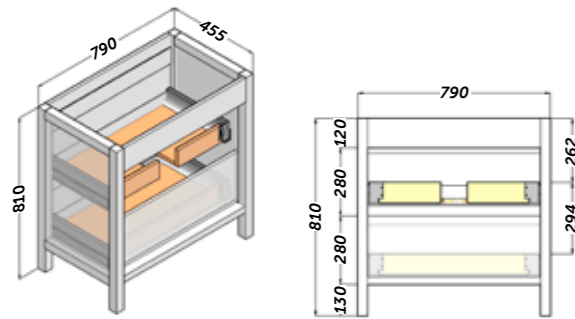

## TRENT 100

Acabado	Referencia
Blanco mate	195 01 100
Gris mate	195 03 100

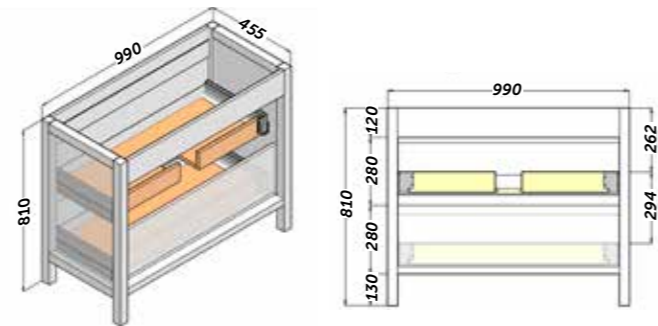

# ESCORPIO



MADE IN SPAIN

## Descripción:

- Mueble a suelo con patas regulables en altura.
- 3 cajones grandes ajustables con cierre amortiguado, interior en acabado textil.
- Frentes regulables de 19 mm.
- Tiradores metálicos.
- Acabados en lacado brillo y melamina texturada.



Interior cajones acabado textil  
Interior of drawer textile finish  
Interiores gaveta em acabamento têxtil  
Interior caixa en acabat textíl  
Ehun-bukaerazko barnekaldeun kajoia  
Interior do caixón en acabado textíl



Guías Hettich  
Hettich drawer sliding system  
Guías Hettich  
Guies Hettich  
Hettich gidak  
Guías Hettich



Cajón con cierre amortiguado  
Drawer fitted with soft closing system  
Gaveta com sistema de corredeiras com amortecedor  
Caixaos amb sistema de tancament suau  
Motelgailudun itxierazko kajoia  
Caixón con peche amortecido



Acabado melamina con textura  
Textured melamine finish  
Cor melamina com textura  
Acabat melamina amb textura  
Testuradun melamina bukatua  
Acabado melamina con textura



Frente cajón regulable  
Adjustable front drawer  
Frente da gaveta ajustável  
Frontal caixa regulable  
Neurirako kajoj aurekaldeta  
Frente do caixón axustable



Acabado lacado brillo  
High gloss lacquered finish  
Cor lacado brillo  
Acabat lacat brilant  
Distiradun lakatzuko bukatua  
Acabado lacado brillo

- |   |  |  |
|---|--|--|
| ○ Blanco<br>White<br>Branco<br>Blanc<br>Zuri<br>Branco  | ● Gris<br>Grey<br>Cinzentto<br>Gris<br>Gris<br>Gris                                  | ● Roble natural<br>Natural oak<br>Carvalho natural<br>Roure natural<br>Haritz naturala<br>Carballo natural |
| ● Nogal oscuro<br>Dark walnut<br>Nogueira escuro<br>Nogueira fosc<br>Intxaurreondo iluna<br>Nogueira escura | ● Pino gris<br>Grey pine<br>Pinho cinzentto<br>Pi gris<br>Pínu grisa<br>Piñeiro gris |  |

## ESCORPIO 60

Acabado	Referencia
Blanco	123 01 060
Gris	123 03 060
Roble natural	123 24 060
Pino gris	123 37 060
Nogal oscuro	123 39 060

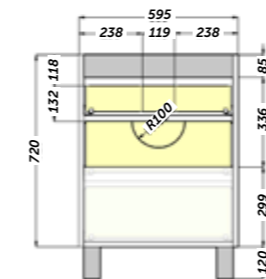
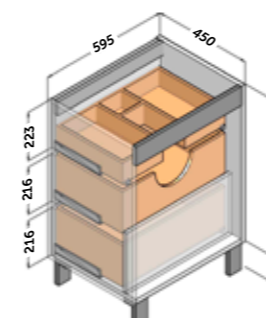

## ESCORPIO 70

Acabado	Referencia
Blanco	123 01 070
Gris	123 03 070
Roble natural	123 24 070
Pino gris	123 37 070
Nogal oscuro	123 39 070

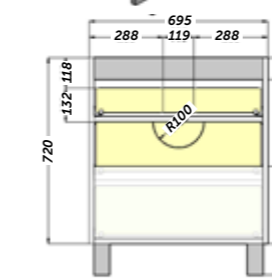
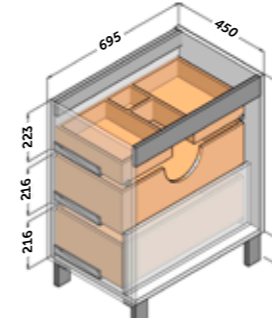

## ESCORPIO 80

Acabado	Referencia
Blanco	123 01 080
Gris	123 03 080
Roble natural	123 24 080
Pino gris	123 37 080
Nogal oscuro	123 39 080

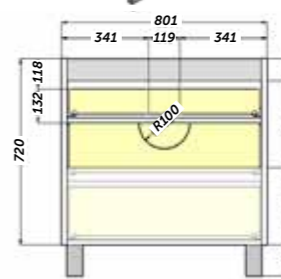
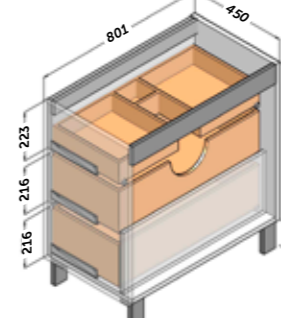

## ESCORPIO 100

Acabado	Referencia
Blanco	123 01 100
Gris	123 03 100
Roble natural	123 24 100
Pino gris	123 37 100
Nogal oscuro	123 39 100

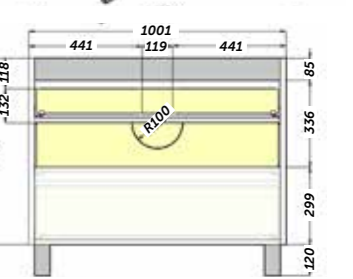
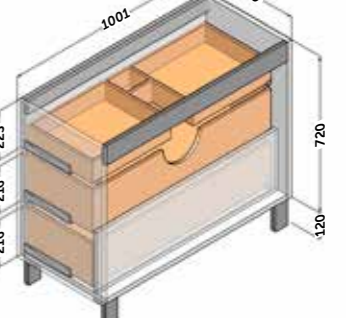

## AUXILIARES / auxiliary units / auxiliares / auxiliars / osagarriak / auxiliares

### JOKER columna

Acabado	Referencia
○ Blanco	137 01 335
● Gris	137 03 335
● Roble natural	137 24 335
● Pino gris	137 37 335
● Nogal oscuro	137 39 335

### JOKER colgar

Acabado	Referencia
○ Blanco	137 01 435
● Gris	137 03 435
● Roble natural	137 24 435
● Pino gris	137 37 435
● Nogal oscuro	137 39 435

### JOKER auxiliar

Acabado	Referencia
○ Blanco	137 01 445
● Gris	137 03 445
● Roble natural	137 24 445
● Pino gris	137 37 445
● Nogal oscuro	137 39 445

# TAURO



MADE IN SPAIN

## Descripción:

- Mueble a suelo con patas regulables en altura.
- 2 cajones grandes ajustables con cierre amortiguado, interior en acabado textil.
- Puerta en la parte derecha, incluye estante en interior.
- Frontes regulables de 19 mm.
- Tiradores metálicos
- Acabados en lacado brillo y melamina texturada.



Interior cajones acabado textil  
Interior of drawer textile finish  
Interiores gaveta em acabamento têxtil  
Interior calaix en acabat tèxtil  
Ehun-bukaerazko barnekaldeudun kajoia  
Interior do caixón en acabado têxtil



Cajón con cierre amortiguado  
Drawer fitted with soft closing system  
Gaveta com sistema de corredeiras com amortecedor  
Calaixos amb sistema de tancament suau  
Motelgailudun itxierazko kajoia  
Caixón con peche amortecido



Fronte cajón regulable  
Adjustable front drawer  
Fronte da gaveta ajustável  
Frontal calaix regulable  
Neurrirako kajoï aurrekaldea  
Fronte do caixón axustable



Guías Hettich  
Hettich drawer sliding system  
Guías Hettich  
Guies Hettich  
Hettich gidak  
Guías Hettich



Puerta con cierre amortiguado  
Door with soft closing system  
Porta com amortecedor  
Porta amb sistema de tancament suau  
Motelgailudun itxierazko atea  
Porta con peche amortecido



Acabado melamina con textura  
Textured melamine finish  
Cor melamina com textura  
Acabat melamina amb textura  
Testuradun melanina bukatua  
Acabado melanina con textura



Acabado lacado brillo  
High gloss lacquered finish  
Cor lacado brillo  
Acabat lacat brillant  
Distiradun lakatzuko bukatua  
Acabado lacado brillo

	Blanco White Branco		Gris Grey Cinzentu		Roble natural Natural oak Carvalho natural
	Zuria Branco		Grisa Gris		Roble natural Haritz naturala Carballo natural
	Roble medio Medium oak Carvalho médio		Wengué Wenge Wengué		
	Haritz ertainekoa Carballo medio		Wengué Wenge Wengué		

## TAURO 70

Acabado	Referencia
Blanco	122 01 070
Gris	122 03 070
Roble natural	122 24 070
Roble medio	122 21 070
Wengué	122 20 070

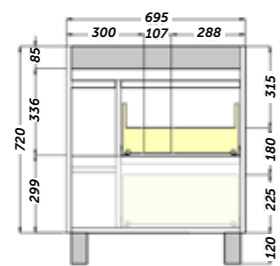
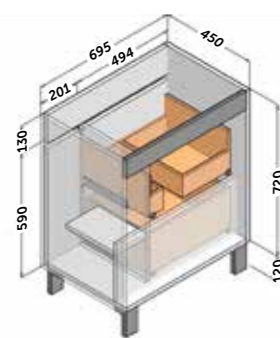

## TAURO 80

Acabado	Referencia
Blanco	122 01 080
Gris	122 03 080
Roble natural	122 24 080
Roble medio	122 21 080
Wengué	122 20 080

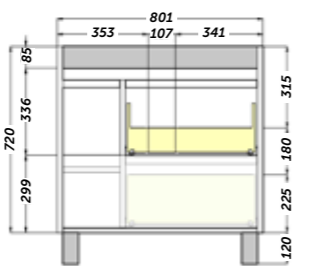
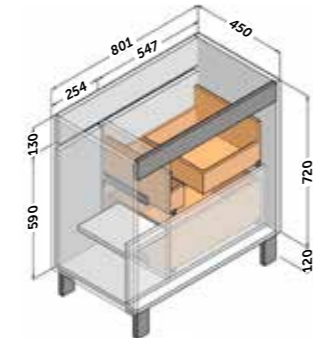

## TAURO 100

Acabado	Referencia
Blanco	122 01 100
Gris	122 03 100
Roble natural	122 24 100
Roble medio	122 21 100
Wengué	122 20 100

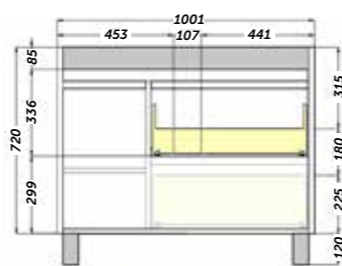
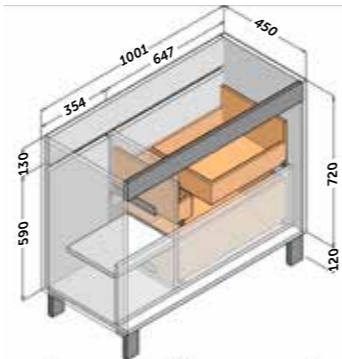

## AUXILIARES / auxiliary units / auxiliares / auxiliars / osagarriak / auxiliares

### JOKER columna

Acabado	Referencia
Blanco	137 01 335
Gris	137 03 335
Roble natural	137 24 335
Roble medio	137 21 335
Wengué	137 20 335

### JOKER colgar

Acabado	Referencia
Blanco	137 01 435
Gris	137 03 435
Roble natural	137 24 435
Roble medio	137 21 435
Wengué	137 20 435

### JOKER auxiliar

Acabado	Referencia
Blanco	137 01 445
Gris	137 03 445
Roble natural	137 24 445
Roble medio	137 21 445
Wengué	137 20 445

# WOOD



MADE IN SPAIN

## Descripción:

- Mueble a suelo con patas regulables en altura.
- 3 cajones grandes regulables con cierre amortiguado, interior en acabado textil.
- Puerta en la parte derecha, incluye estante en interior.
- Frontes regulables de 22 mm.
- Tiradores integrados
- Acabados en blanco mate y melamina texturada.



Interior cajones acabado textil  
Interior of drawer textile finish  
Interiores gaveta em acabamento têxtil  
Interior calaix en acabat tèxtil  
Ehun-bukaerazko barnekaldeudun kajoia  
Interior do caixón en acabado têxtil



Cajón con cierre amortiguado  
Drawer fitted with soft closing system  
Gaveta com sistema de corredeiras com amortecedor  
Calaixos amb sistema de tancament suau  
Motelgailudun itxierazko kajoia  
Caixón con peche amortecido



Fronte cajón regulable  
Adjustable front drawer  
Fronte da gaveta ajustável  
Frontal calaix regulable  
Neurrirako kajoï aurrekaldea  
Fronte do caixón axustable



Guías Hettich  
Hettich drawer sliding system  
Guías Hettich  
Guies Hettich  
Hettich gidak  
Guías Hettich



Puerta con cierre amortiguado  
Door with soft closing system  
Porta com amortecedor  
Porta amb sistema de tancament suau  
Motelgailudun itxierazko atea  
Porta con peche amortecido



Acabado melamina con textura  
Textured melamine finish  
Cor melamina com textura  
Acabat melamina amb textura  
Testuradun melanina bukatua  
Acabado melanina con textura

	Blanco mate / Roble natural Matte White / Natural oak Branco mate / Carvalho natural Blanc mat / Roure natural Zuri matea / Haritz naturala Branco mate / Carballo natural		Blanco mate / Vintage Matte White / Vintage Branco mate / Vintage Blanc mat / Vintage Zuri matea / Vintage Branco mate / Vintage
--	---	--	---

	Blanco mate / Pino gris Matte White / Grey pine Branco mate / Pinho cinzento Blanc mat / Pi gris Zuri matea / Pinu gris Branco mate / Piñeiro gris
--	---

## WOOD 80

Acabado	Referencia
Blanco mate/Roble natural	134 40 080
Blanco mate/Vintage	134 43 080
Blanco mate/Pino gris	134 41 080

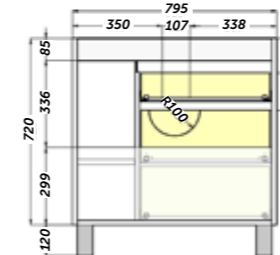
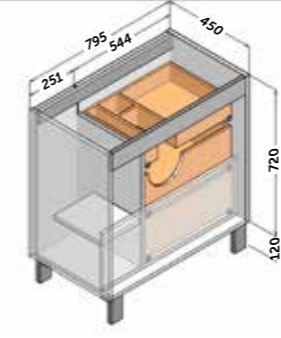

## WOOD 100

Acabado	Referencia
Blanco mate/Roble natural	134 40 100
Blanco mate/Vintage	134 43 100
Blanco mate/Pino gris	134 41 100

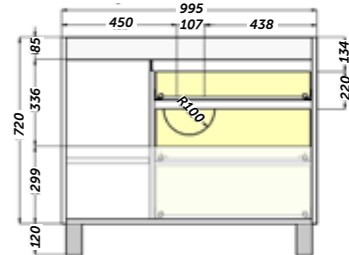
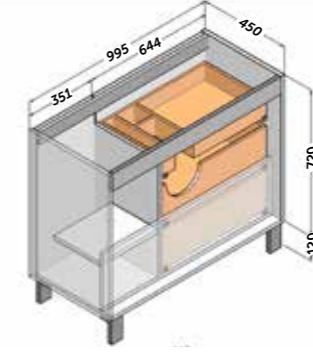

## AUXILIARES / auxiliary units / auxiliares / auxiliars / osagarriak / auxiliares

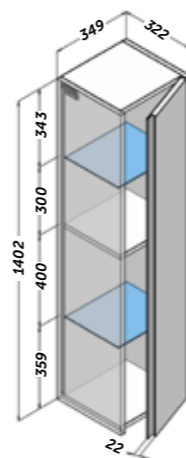

### WOOD columna

Acabado	Referencia
Blanco mate/Roble natural	134 40 335
Blanco mate/Vintage	134 43 335
Blanco mate/Pino gris	134 41 335

El estante de cristal puede cambiar de posición +/- 64 mm



Puerta con cierre amortiguado  
Door with soft closing system  
Porta com amortecedor  
Porta amb sistema de tancament suau  
Motelgailudun itxierazko atea  
Porta con peche amortecido

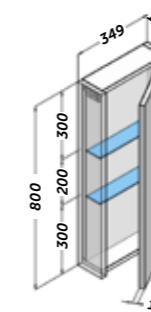

### JOKER colgar

Acabado	Referencia
Roble natural	137 24 435
Pino gris	137 37 435

El estante de cristal puede cambiar de posición +/- 32 mm



Puerta con cierre amortiguado  
Door with soft closing system  
Porta com amortecedor  
Porta amb sistema de tancament suau  
Motelgailudun itxierazko atea  
Porta con peche amortecido

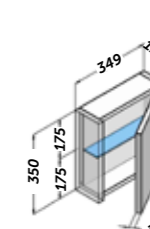

### JOKER auxiliar

Acabado	Referencia
Roble natural	137 24 445
Pino gris	137 37 445

El estante de cristal puede cambiar de posición +/- 32 mm



Puerta con cierre amortiguado  
Door with soft closing system  
Porta com amortecedor  
Porta amb sistema de tancament suau  
Motelgailudun itxierazko atea  
Porta con peche amortecido

# MAR



MADE IN SPAIN

## Descripción:

- Mueble a suelo con patas regulables en altura.
- 2 cajones grandes regulable con cierre amortiguado, interior en acabado textil.
- Puerta en la parte derecha, incluye estante en interior.
- Frontes regulables de 19 mm.
- Tiradores metálicos.
- Acabados en lacado brillo y melamina texturada.



Interior cajones acabado textil  
Interior of drawer textile finish  
Interiores gaveta em acabamento têxtil  
Interior calaix en acabat tèxtil  
Ehun-bukaerazko barnekaldeudun kajoia  
Interior do caixón en acabado têxtil



Puerta con cierre amortiguado  
Door with soft closing system  
Porta com amortecedor  
Porta amb sistema de tancament suau  
Motelgailudun itxierazko atea  
Porta con peche amortecido



Cajón con cierre amortiguado  
Drawer fitted with soft closing system  
Gaveta com sistema de corredeiras com amortecedor  
Caiixos amb sistema de tancament suau  
Motelgailudun itxierazko kajoia  
Caixón con peche amortecido



Acabado melamina con textura  
Textured melamine finish  
Cor melamina com textura  
Acabat melamina amb textura  
Testuradun melamina bukatua  
Acabado melamina con textura



Fronte cajón regulable  
Adjustable front drawer  
Fronte da gaveta ajustável  
Frontal calaix regulable  
Neurrirako kajoï aurrekaldea  
Fronte do caixón axustable



Acabado lacado brillo  
High gloss lacquered finish  
Cor lacado brillo  
Acabat lacat brillant  
Distiradun lakatzuko bukatua  
Acabado lacado brillo



Guías Hettich  
Hettich drawer sliding system  
Guías Hettich  
Guies Hettich  
Hettich gidak  
Guías Hettich

- Blanco  
White  
Branco
- Roble natural  
Natural oak  
Carvalho natural  
Roure natural  
Haritz naturala  
Carballo natural
- Nogal oscuro  
Dark walnut  
Nogueira escuro  
Nogueira fosca  
Intxaurrondo iluna  
Nogueira escura

## MAR 90

Acabado	Referencia
Blanco	133 01 090 305
Roble natural	133 24 090 285
Nogal oscuro	133 39 090 285

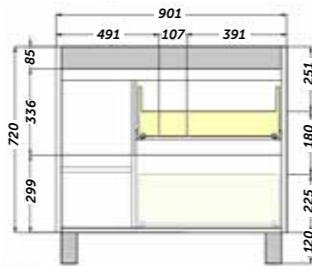
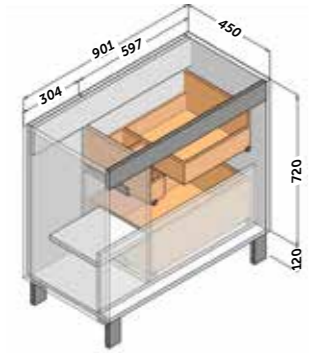

# HOLE



MADE IN SPAIN

## Descripción:

- Mueble suspendido. Sujeción regulable en altura y profundidad con sistema antivuelco.
- 2 cajones grandes regulables con cierre amortiguado, interior en acabado textil.
- 2 huecos en la parte derecha.
- Frontes regulables de 22 mm.
- Tiradores integrados.
- Acabados en melamina texturada.



Interior cajones acabado textil  
Interior of drawer textile finish  
Interiores gaveta em acabamento têxtil  
Interior calaix en acabat tèxtil  
Ehun-bukaerazko barnekaldeudun kajoia  
Interior do caixón en acabado têxtil



Guías Hettich  
Hettich drawer sliding system  
Guías Hettich  
Guies Hettich  
Hettich gidak  
Guías Hettich



Cajón con cierre amortiguado  
Drawer fitted with soft closing system  
Gaveta com sistema de corredeiras com amortecedor  
Caiixos amb sistema de tancament suau  
Motelgailudun itxierazko kajoia  
Caixón con peche amortecido



Acabado melamina con textura  
Textured melamine finish  
Cor melamina com textura  
Acabat melamina amb textura  
Testuradun melamina bukatua  
Acabado melamina con textura



Fronte cajón regulable  
Adjustable front drawer  
Fronte da gaveta ajustável  
Frontal calaix regulable  
Neurrirako kajoï aurrekaldea  
Fronte do caixón axustable

- Roble natural  
Natural oak  
Carvalho natural  
Roure natural  
Haritz naturala  
Carballo natural
- Pino gris  
Grey pine  
Pinho cinzento  
Pi gris  
Pino grisá  
Piñeiro gris

## HOLE 80

Acabado	Referencia
Roble natural	132 24 080
Pino gris	132 37 080

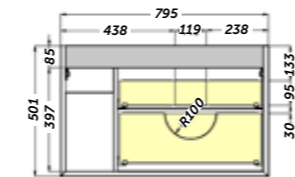
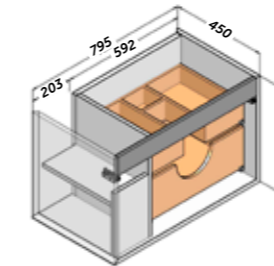

## HOLE 90

Acabado	Referencia
Roble natural	132 24 090
Pino gris	132 37 090

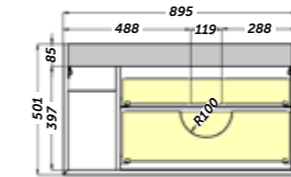
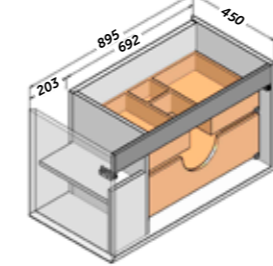

## HOLE 100

Acabado	Referencia
Roble natural	132 24 100
Pino gris	132 37 100

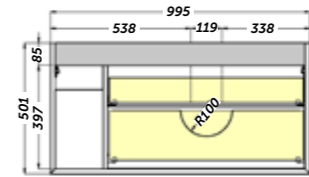
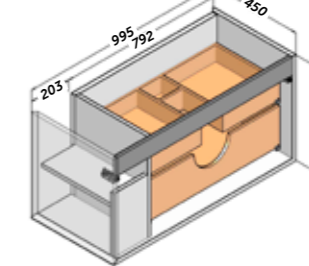

## AUXILIARES / auxiliary units / auxiliares / auxiliars / osagarriak / auxiliares

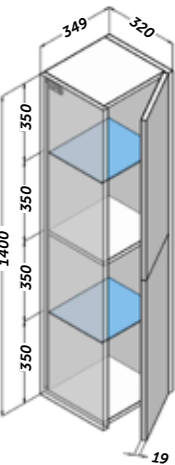

### JOKER columna

Acabado	Referencia
Blanco	137 01 335
Roble natural	137 24 335
Nogal oscuro	137 39 335

El estante de cristal puede cambiar de posición +/- 64 mm



Puerta con cierre amortiguado  
Door with soft closing system  
Porta com amortecedor  
Porta amb sistema de tancament suau  
Motelgailudun itxierazko atea  
Porta con peche amortecido

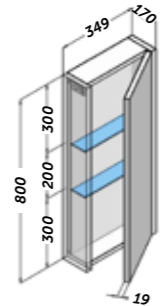

### JOKER colgar

Acabado	Referencia
Blanco	137 01 435
Roble natural	137 24 435
Nogal oscuro	137 39 435

El estante de cristal puede cambiar de posición +/- 32 mm



Puerta con cierre amortiguado  
Door with soft closing system  
Porta com amortecedor  
Porta amb sistema de tancament suau  
Motelgailudun itxierazko atea  
Porta con peche amortecido

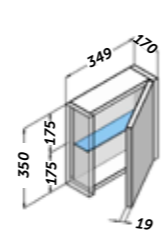

### JOKER auxiliar

Acabado	Referencia
Blanco	137 01 445
Roble natural	137 24 445
Nogal oscuro	137 39 445

El estante de cristal puede cambiar de posición +/- 32 mm



Puerta con cierre amortiguado  
Door with soft closing system  
Porta com amortecedor  
Porta amb sistema de tancament suau  
Motelgailudun itxierazko atea  
Porta con peche amortecido

## AUXILIARES / auxiliary units / auxiliares / auxiliars / osagarriak / auxiliares

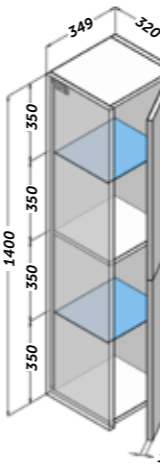

### JOKER columna

Acabado	Referencia
Roble natural	137 24 335
Pino gris	137 37 335

El estante de cristal puede cambiar de posición +/- 64 mm



Puerta con cierre amortiguado  
Door with soft closing system  
Porta com amortecedor  
Porta amb sistema de tancament suau  
Motelgailudun itxierazko atea  
Porta con peche amortecido

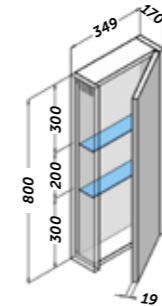

### JOKER colgar

Acabado	Referencia
Roble natural	137 24 435
Pino gris	137 37 435

El estante de cristal puede cambiar de posición +/- 32 mm



Puerta con cierre amortiguado  
Door with soft closing system  
Porta com amortecedor  
Porta amb sistema de tancament suau  
Motelgailudun itxierazko atea  
Porta con peche amortecido

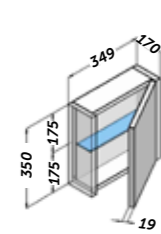

### JOKER auxiliar

Acabado	Referencia
Roble natural	137 24 445
Pino gris	137 37 445

El estante de cristal puede cambiar de posición +/- 32 mm



Puerta con cierre amortiguado  
Door with soft closing system  
Porta com amortecedor  
Porta amb sistema de tancament suau  
Motelgailudun itxierazko atea  
Porta con peche amortecido

# ARIES



## Descripción:

- Mueble suspendido. Sujeción regulable en altura y profundidad con sistema antivuelco.
- 2 cajones grandes regulables con cierre amortiguado, interior en acabado textil.
- Puerta en la parte derecha, incluye estante en interior.
- Frentes regulables de 19 mm.
- Tiradores metálicos.
- Acabados en lacado brillo y melamina texturada.



Interior cajones acabado textil  
Interior of drawer textile finish  
Interiores gaveta em acabamento têxtil  
Interior caixa en acabat tèxtil  
Ehun-bukaerazko barnekaldedun kajoia  
Interior do caixón en acabado têxtil



Cajón con cierre amortiguado  
Drawer fitted with soft closing system  
Gaveta com sistema de correções com amortecedor  
Calaixos amb sistema de tancament suau  
Motelgailudun itxierazko kajoia  
Caixón do peche amortecido



Frente cajón regulable  
Adjustable front drawer  
Frente da gaveta ajustável  
Frontal caixa regulable  
Neurriko kajoj aurrekaldea  
Fronte do caixón axustable



Guías Hettich  
Hettich drawer sliding system  
Guias Hettich  
Guias Hettich  
Hettich gidak  
Guias Hettich



Puerta con cierre amortiguado  
Door with soft closing system  
Porta com amortecedor  
Porta amb sistema de tancament suau  
Motelgailudun itxierazko atea  
Porta con peche amortecido



Acabado melamina con textura  
Textured melamine finish  
Cor melamina con textura  
Acabat melamina amb textura  
Testuradun melamina bukatua  
Acabado melamina con textura



Acabado lacado brillo  
High gloss lacquered finish  
Cor lacado brilho  
Acabat lacat brillant  
Distiradun lakatzuko bukatua  
Acabado lacado brillo



## ARIES 70

Acabado	Referencia
Blanco	121 01 070
Roble natural	121 24 070
Roble medio	121 21 070
Wengué	121 20 070

## ARIES 80

Acabado	Referencia
Blanco	121 01 080
Roble natural	121 24 080
Roble medio	121 21 080
Wengué	121 20 080

## ARIES 100

Acabado	Referencia
Blanco	121 01 100
Roble natural	121 24 100
Roble medio	121 21 100
Wengué	121 20 100

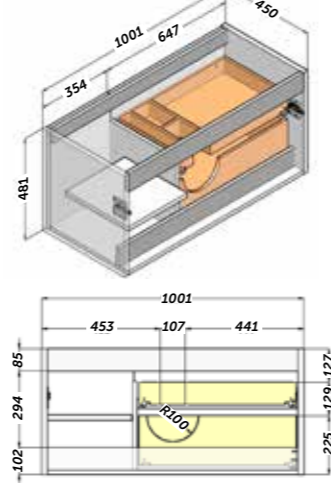
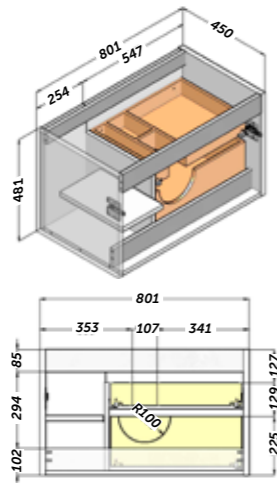
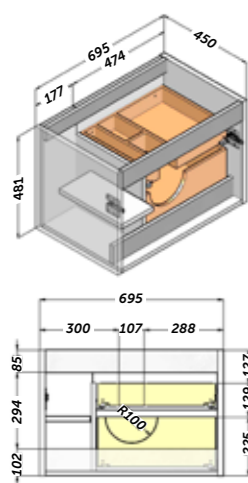

## TAPA ARIES

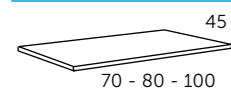

TAPA 70		TAPA 80		TAPA 100	
Acabado	Referencia	Referencia	Referencia	Referencia	Referencia
Blanco	121 01 207	121 01 208	121 01 210	121 01 207	121 01 208
Roble natural	121 24 207	121 24 208	121 24 210	121 24 207	121 24 208
Roble medio	121 21 207	121 21 208	121 21 210	121 21 207	121 21 208
Wengué	121 20 207	121 20 208	121 20 210	121 20 207	121 20 208

## AUXILIARES

### JOKER columna

Acabado	Referencia
Blanco	137 01 335
Roble natural	137 24 335
Roble medio	137 21 335
Wengué	137 20 335

### JOKER colgar

Acabado	Referencia
Blanco	137 01 435
Roble natural	137 24 435
Roble medio	137 21 435
Wengué	137 20 435

### JOKER auxiliar

Acabado	Referencia
Blanco	137 01 445
Roble natural	137 24 445
Roble medio	137 21 445
Wengué	137 20 445

# GALSAKY



## Descripción:

- Mueble suspendido. Sujeción regulable en altura y profundidad con sistema antivuelco.
- 2 cajones grandes regulables con cierre amortiguado, en acabado textil.
- Frentes regulables de 19 mm.
- Tiradores metálicos.
- Acabados en lacado brillo y melamina texturada.



Interior cajones acabado textil  
Interior of drawer textile finish  
Interiores gaveta em acabamento têxtil  
Interior caixa en acabat tèxtil  
Ehun-bukaerazko barnekaldedun kajoia  
Interior do caixón en acabado têxtil



Cajón con cierre amortiguado  
Drawer fitted with soft closing system  
Gaveta com sistema de correções com amortecedor  
Calaixos amb sistema de tancament suau  
Motelgailudun itxierazko kajoia  
Caixón do peche amortecido



Frente cajón regulable  
Adjustable front drawer  
Frente da gaveta ajustável  
Frontal caixa regulable  
Neurriko kajoj aurrekaldea  
Fronte do caixón axustable



Guías Hettich  
Hettich drawer sliding system  
Guias Hettich  
Guias Hettich  
Hettich gidak  
Guias Hettich



Acabado melamina con textura  
Textured melamine finish  
Cor melamina con textura  
Acabat melamina amb textura  
Testuradun melamina bukatua  
Acabado melamina con textura



Acabado lacado brillo  
High gloss lacquered finish  
Cor lacado brilho  
Acabat lacat brillant  
Distiradun lakatzuko bukatua  
Acabado lacado brillo



## GALSAKY 60

Acabado	Referencia
Blanco	151 01 060
Gris	151 03 060
Roble natural	151 24 060
Roble medio	151 21 060
Nogal oscuro	151 39 060

## GALSAKY 70

Acabado	Referencia
Blanco	151 01 070
Gris	151 03 070
Roble natural	151 24 070
Roble medio	151 21 070
Nogal oscuro	151 39 070

## GALSAKY 80

Acabado	Referencia
Blanco	151 01 080
Gris	151 03 080
Roble natural	151 24 080
Roble medio	151 21 080
Nogal oscuro	151 39 080

## GALSAKY 100

Acabado	Referencia
Blanco	151 01 100
Gris	151 03 100
Roble natural	151 24 100
Roble medio	151 21 100
Nogal oscuro	151 39 100

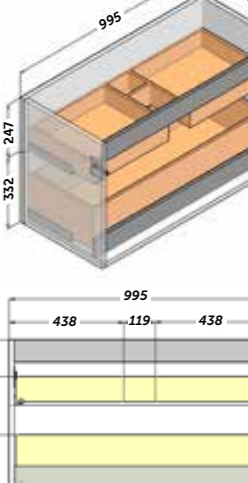
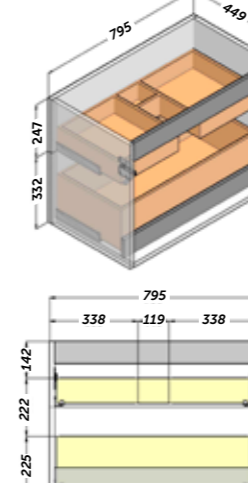
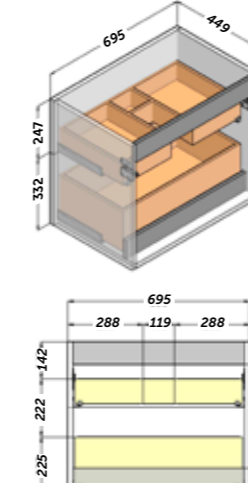
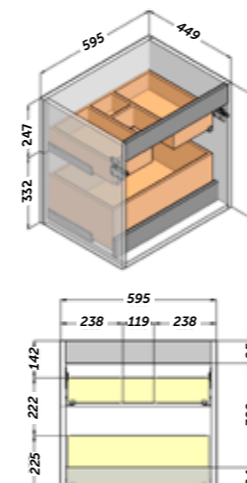

## AUXILIARES / auxiliary units / auxiliares / auxiliars / osagarriak / auxiliares

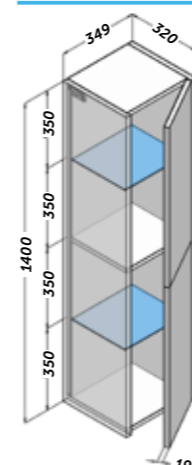

### JOKER columna

Acabado	Referencia
Blanco	137 01 335
Gris	137 03 335
Roble natural	137 24 335
Roble medio	137 21 335
Nogal oscuro	137 39 335

El estante de cristal puede cambiar de posición +/- 64 mm



Puerta con cierre amortiguado  
Door with soft closing system  
Porta com amortecedor  
Porta amb sistema de tancament suau  
Motelgailudun itxierazko atea  
Porta con peche amortecido

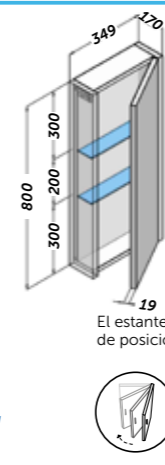

### JOKER colgar

Acabado	Referencia
Blanco	137 01 435
Gris	137 03 435
Roble natural	137 24 435
Roble medio	137 21 435
Nogal oscuro	137 39 435

El estante de cristal puede cambiar de posición +/- 32 mm



Puerta con cierre amortiguado  
Door with soft closing system  
Porta com amortecedor  
Porta amb sistema de tancament suau  
Motelgailudun itxierazko atea  
Porta con peche amortecido

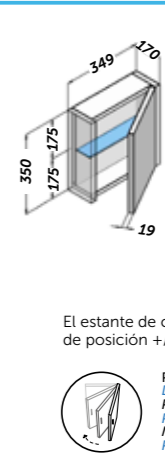

### JOKER auxiliar

Acabado	Referencia
Blanco	137 01 445
Gris	137 03 445
Roble natural	137 24 445
Roble medio	137 21 445
Nogal oscuro	137 39 445

El estante de cristal puede cambiar de posición +/- 32 mm



Puerta con cierre amortiguado  
Door with soft closing system  
Porta com amortecedor  
Porta amb sistema de tancament suau  
Motelgailudun itxierazko atea  
Porta con peche amortecido

# SMALL



MADE IN SPAIN

- Blanco
- White
- Branco
- Blanc
- Zuria
- Branco
- Roble natural
- Natural oak
- Carvalho natural
- Roure natural
- Haritz naturala
- Carballo natural

## Descripción:

- Mueble a suelo con patas regulables en altura. Fondo reducido.
- Puertas asimétricas, amplio interior.
- Cajón inferior regulable con cierre amortiguado, interior en acabado textil.
- Frentes regulables de 19 mm.
- Tiradores metálicos.
- Acabados en lacado brillo y melamina texturada.



Interior cajones acabado textil  
Interior of drawer textile finish  
Interiores gaveta em acabamento têxtil  
Interior calaix en acabat tèxtil  
Ehun-bukaerazko barnekaldean kajoia  
Interior do caixón en acabado têxtil



Puerta con cierre amortiguado  
Door with soft closing system  
Porta com amortecedor  
Porta amb sistema de tancament suau  
Motelgailudun itxierazko atea  
Porta con peche amortecido



Cajón con cierre amortiguado  
Drawer fitted with soft closing system  
Gaveta com sistema de corredeiras com amortecedor  
Calaixos amb sistema de tancament suau  
Motelgailudun itxierazko kajoia  
Caixón con peche amortecido



Acabado melamina con textura  
Textured melamine finish  
Cor melamina con textura  
Acabat melamina amb textura  
Testuradun melamina bukatua  
Acabado melamina con textura



Frente cajón regulable  
Adjustable front drawer  
Frente da gaveta ajustável  
Frontal calaix regulable  
Neurrirako kajoï aurrekaldea  
Fronte do caixón axustable



Acabado lacado brillo  
High gloss lacquered finish  
Cor lacado brilho  
Acabat lacat brillant  
Distiradun lakatzuko bukatua  
Acabado lacado brillo



Guías Hettich  
Hettich drawer sliding system  
Guias Hettich  
Guias Hettich  
Hettich gidak  
Guias Hettich

## SMALL 50

Acabado	Referencia
Blanco	135 01 050
Roble natural	135 24 050

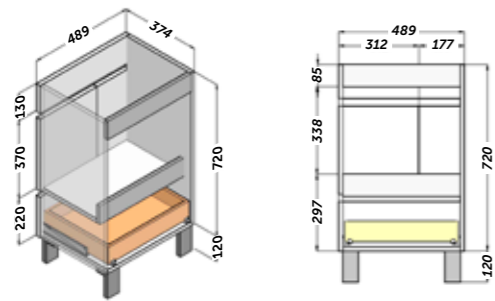

## SMALL 60

Acabado	Referencia
Blanco	135 01 060
Roble natural	135 24 060

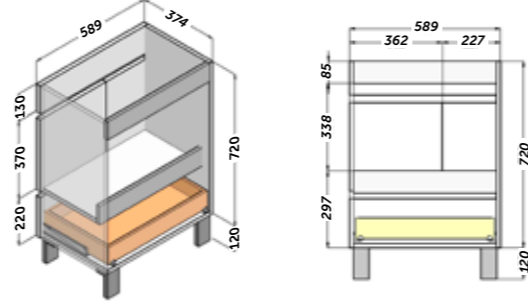

# HOMY



MADE IN SPAIN

- Blanco
- White
- Branco
- Blanc
- Zuria
- Branco
- Roble natural
- Natural oak
- Carvalho natural
- Roure natural
- Haritz naturala
- Carballo natural

## Descripción:

- Mueble a suelo con patas regulables en altura. Fondo reducido.
- 2 cajones grandes regulables con cierre amortiguado, interior en acabado textil.
- Frentes regulables de 19 mm.
- Tiradores metálicos.
- Acabados en lacado brillo y melamina texturada.



Interior cajones acabado textil  
Interior of drawer textile finish  
Interiores gaveta em acabamento têxtil  
Interior calaix en acabat tèxtil  
Ehun-bukaerazko barnekaldean kajoia  
Interior do caixón en acabado têxtil



Guías Hettich  
Hettich drawer sliding system  
Guias Hettich  
Guias Hettich  
Hettich gidak  
Guias Hettich



Cajón con cierre amortiguado  
Drawer fitted with soft closing system  
Gaveta com sistema de corredeiras com amortecedor  
Calaixos amb sistema de tancament suau  
Motelgailudun itxierazko kajoia  
Caixón con peche amortecido



Acabado melamina con textura  
Textured melamine finish  
Cor melamina con textura  
Acabat melamina amb textura  
Testuradun melamina bukatua  
Acabado melamina con textura



Frente cajón regulable  
Adjustable front drawer  
Frente da gaveta ajustável  
Frontal calaix regulable  
Neurrirako kajoï aurrekaldea  
Fronte do caixón axustable



Acabado lacado brillo  
High gloss lacquered finish  
Cor lacado brilho  
Acabat lacat brillant  
Distiradun lakatzuko bukatua  
Acabado lacado brillo

## HOMY 70

Acabado	Referencia
Blanco	136 01 070
Roble natural	136 24 070

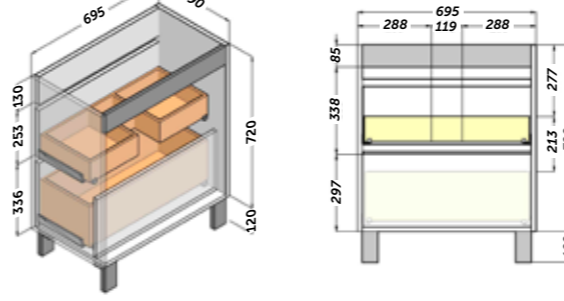

## HOMY 80

Acabado	Referencia
Blanco	136 01 080
Roble natural	136 24 080

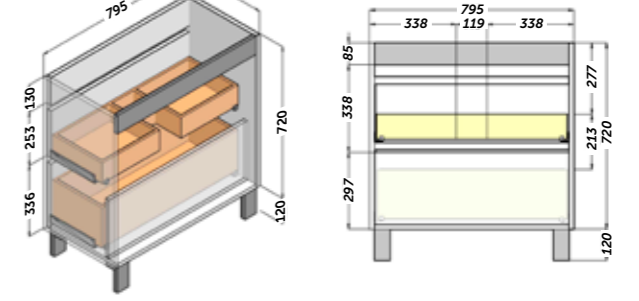

## AUXILIARES / auxiliary units / auxiliares / auxiliars / osagarriak / auxiliares

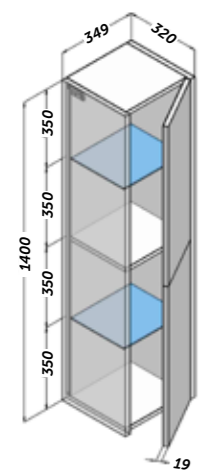

### JOKER columna

Acabado	Referencia
Blanco	137 01 335
Roble natural	137 24 335

El estante de cristal puede cambiar de posición +/- 64 mm



Puerta con cierre amortiguado  
Door with soft closing system  
Porta com amortecedor  
Porta amb sistema de tancament suau  
Motelgailudun itxierazko atea  
Porta con peche amortecido

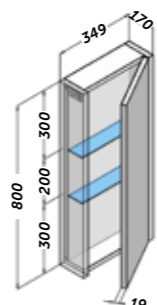

### JOKER colgar

Acabado	Referencia
Blanco	137 01 435
Roble natural	137 24 435

El estante de cristal puede cambiar de posición +/- 32 mm



Puerta con cierre amortiguado  
Door with soft closing system  
Porta com amortecedor  
Porta amb sistema de tancament suau  
Motelgailudun itxierazko atea  
Porta con peche amortecido

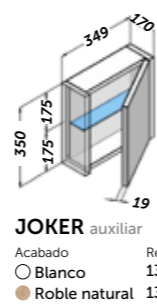

### JOKER auxiliar

Acabado	Referencia
Blanco	137 01 445
Roble natural	137 24 445

El estante de cristal puede cambiar de posición +/- 32 mm



Puerta con cierre amortiguado  
Door with soft closing system  
Porta com amortecedor  
Porta amb sistema de tancament suau  
Motelgailudun itxierazko atea  
Porta con peche amortecido

## AUXILIARES / auxiliary units / auxiliares / auxiliars / osagarriak / auxiliares

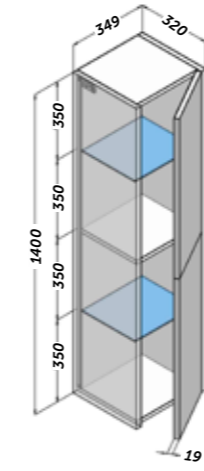

### JOKER columna

Acabado	Referencia
Blanco	137 01 335
Roble natural	137 24 335

El estante de cristal puede cambiar de posición +/- 64 mm



Puerta con cierre amortiguado  
Door with soft closing system  
Porta com amortecedor  
Porta amb sistema de tancament suau  
Motelgailudun itxierazko atea  
Porta con peche amortecido

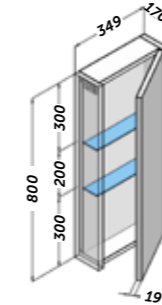

### JOKER colgar

Acabado	Referencia
Blanco	137 01 435
Roble natural	137 24 435

El estante de cristal puede cambiar de posición +/- 32 mm



Puerta con cierre amortiguado  
Door with soft closing system  
Porta com amortecedor  
Porta amb sistema de tancament suau  
Motelgailudun itxierazko atea  
Porta con peche amortecido



### JOKER auxiliar

Acabado	Referencia
Blanco	137 01 445
Roble natural	137 24 445

El estante de cristal puede cambiar de posición +/- 32 mm



Puerta con cierre amortiguado  
Door with soft closing system  
Porta com amortecedor  
Porta amb sistema de tancament suau  
Motelgailudun itxierazko atea  
Porta con peche amortecido

# COMET



MADE IN SPAIN

## Descripción:

- Mueble suspendido de fondo reducido. Sujeción regulable en altura y profundidad con sistema antivuelco.
- 2 cajones regulables con cierre amortiguado en acabado textil.
- Frontes regulables de 19 mm.
- Tiradores metálicos.
- Acabados en lacado brillo y melamina texturada.



Interior cajones acabado textil  
Interior of drawer textile finish  
Interiores gaveta em acabamento têxtil  
Interior calaix en acabat tèxtil  
Ehun-bukaerazko barnekaldean kajoia  
Interior do caixón en acabado textil



Cajón con cierre amortiguado  
Drawer fitted with soft closing system  
Gaveta com sistema de corredeiras com amortecedor  
Calaixos amb sistema de tancament suau  
Motelgailudun itxierazko kajoia  
Caixón con peche amortecido



Fronte cajón regulable  
Adjustable front drawer  
Fronte da gaveta ajustável  
Frontal calaix regulable  
Neurriako kajoj aurrekaldea  
Fronte do caixón axustable



Guías Hettich  
Hettich drawer sliding system  
Guías Hettich  
Guias Hettich  
Hettich gidak  
Guias Hettich



Acabado melamina con textura  
Textured melamine finish  
Cor melamina com textura  
Acabat melamina amb textura  
Testuradun melamina bukatua  
Acabado melamina con textura



Acabado lacado brillo  
High gloss lacquered finish  
Cor lacado brillo  
Acabat lacat brillant  
Distiradun lakatzuko bukatua  
Acabado lacado brillo

- Blanco
- White
- Branco
- Blanc
- Zuria
- Branco

- Roble natural
- Natural oak
- Carvalho natural
- Roure natural
- Haritz naturala
- Carballo natural

## COMET 60

Acabado	Referencia
Blanco	152 01 060
Roble natural	152 24 060

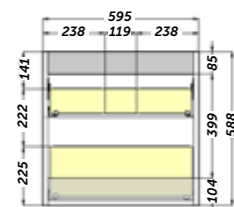
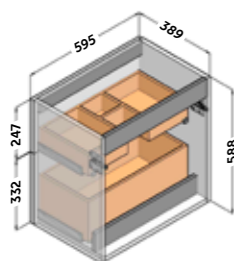

## COMET 70

Acabado	Referencia
Blanco	152 01 070
Roble natural	152 24 070

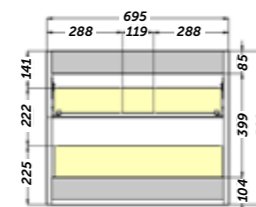
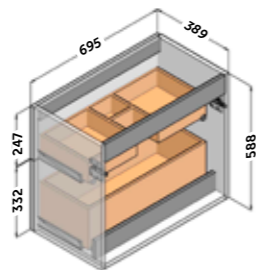

## COMET 80

Acabado	Referencia
Blanco	152 01 080
Roble natural	152 24 080

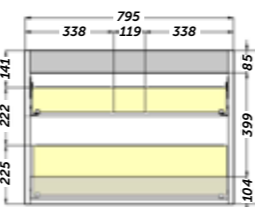
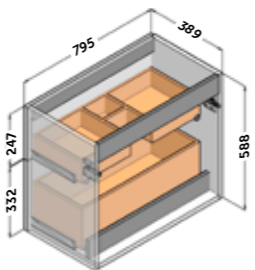

## AUXILIARES / auxiliary units / auxiliares / auxiliars / osagarriak / auxiliares

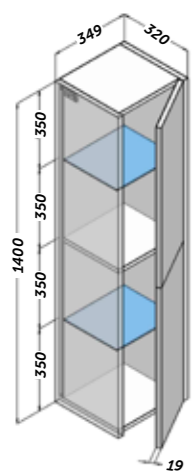

### JOKER columna

Acabado	Referencia
Blanco	137 01 335
Roble natural	137 24 335

El estante de cristal puede cambiar de posición +/- 64 mm



Puerta con cierre amortiguado  
Door with soft closing system  
Porta com amortecedor  
Porta amb sistema de tancament suau  
Motelgailudun itxierazko atea  
Porta con peche amortecido

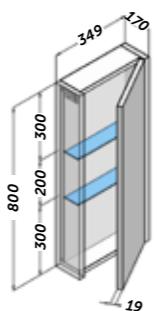

### JOKER colgar

Acabado	Referencia
Blanco	137 01 435
Roble natural	137 24 435

El estante de cristal puede cambiar de posición +/- 32 mm



Puerta con cierre amortiguado  
Door with soft closing system  
Porta com amortecedor  
Porta amb sistema de tancament suau  
Motelgailudun itxierazko atea  
Porta con peche amortecido

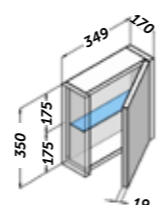

### JOKER auxiliar

Acabado	Referencia
Blanco	137 01 445
Roble natural	137 24 445

El estante de cristal puede cambiar de posición +/- 32 mm



Puerta con cierre amortiguado  
Door with soft closing system  
Porta com amortecedor  
Porta amb sistema de tancament suau  
Motelgailudun itxierazko atea  
Porta con peche amortecido

# TÍVOLI



MADE IN SPAIN

## Descripción:

- Mueble suspendido de fondo reducido. Sujeción regulable en altura y profundidad con sistema antivuelco.
- 2 cajones regulables con cierre amortiguado en acabado textil.
- Frontes regulables de 19 mm.
- Tiradores metálicos.
- Acabados en lacado brillo y melamina texturada.



Interior cajones acabado textil  
Interior of drawer textile finish  
Interiores gaveta em acabamento têxtil  
Interior calaix en acabat tèxtil  
Ehun-bukaerazko barnekaldean kajoia  
Interior do caixón en acabado textil



Cajón con cierre amortiguado  
Drawer fitted with soft closing system  
Gaveta com sistema de corredeiras com amortecedor  
Calaixos amb sistema de tancament suau  
Motelgailudun itxierazko kajoia  
Caixón con peche amortecido



Fronte cajón regulable  
Adjustable front drawer  
Fronte da gaveta ajustável  
Frontal calaix regulable  
Neurriako kajoj aurrekaldea  
Fronte do caixón axustable



Guías Hettich  
Hettich drawer sliding system  
Guías Hettich  
Guias Hettich  
Hettich gidak  
Guias Hettich



Acabado melamina con textura  
Textured melamine finish  
Cor melamina com textura  
Acabat melamina amb textura  
Testuradun melamina bukatua  
Acabado melamina con textura



Acabado lacado brillo  
High gloss lacquered finish  
Cor lacado brillo  
Acabat lacat brillant  
Distiradun lakatzuko bukatua  
Acabado lacado brillo

- Blanco
- White
- Branco
- Blanc
- Zuria
- Branco

- Blanco / Roble natural
- White / Natural oak
- Branco / Carvalho natural
- Blanc / Roure natural
- Zuria / Haritz naturala
- Branco / Carballo natural

## TÍVOLI 80

Acabado	Referencia
Blanco	113 01 080
Blanco / Roble natural	113 24 080

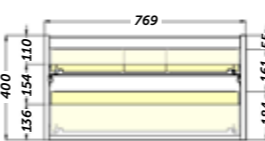
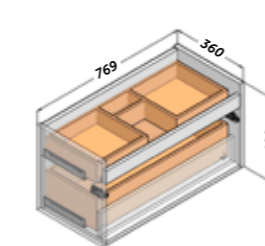

## TÍVOLI 100

Acabado	Referencia
Blanco	113 01 100
Blanco / Roble natural	113 24 100

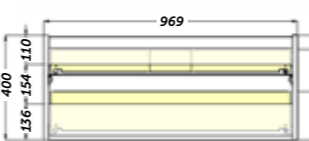

## AUXILIARES / auxiliary units / auxiliares / auxiliars / osagarriak / auxiliares

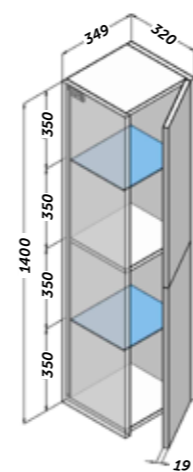

### JOKER columna

Acabado	Referencia
Blanco	137 01 335
Roble natural	137 24 335

El estante de cristal puede cambiar de posición +/- 64 mm



Puerta con cierre amortiguado  
Door with soft closing system  
Porta com amortecedor  
Porta amb sistema de tancament suau  
Motelgailudun itxierazko atea  
Porta con peche amortecido

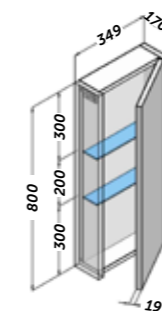

### JOKER colgar

Acabado	Referencia
Blanco	137 01 435
Roble natural	137 24 435

El estante de cristal puede cambiar de posición +/- 32 mm



Puerta con cierre amortiguado  
Door with soft closing system  
Porta com amortecedor  
Porta amb sistema de tancament suau  
Motelgailudun itxierazko atea  
Porta con peche amortecido

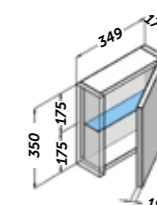

### JOKER auxiliar

Acabado	Referencia
Blanco	137 01 445
Roble natural	137 24 445

El estante de cristal puede cambiar de posición +/- 32 mm



Puerta con cierre amortiguado  
Door with soft closing system  
Porta com amortecedor  
Porta amb sistema de tancament suau  
Motelgailudun itxierazko atea  
Porta con peche amortecido

# MOON



MADE IN SPAIN

## Descripción:

- Mueble suspendido de fondo reducido. Sujeción regulable en altura y profundidad con sistema antivuelco.
- Puerta abatible.
- Cajón inferior regulable con cierre amortiguado, interior en acabado textil.
- Frontes regulables de 19 mm.
- Acabados en lacado brillo y melamina texturada.



Interior cajones acabado textil  
Interior of drawer textile finish  
Interiores gaveta en acabament tèxtil  
Interior calaix en acabament tèxtil  
Ehun-bukaezko barnekaldean kajoia  
Interior do caixon en acabado textil



Puerta con cierre amortiguado  
Door with soft closing system  
Porta com amortecedor  
Porta amb sistema de tancament suau  
Motelgailudun itxierazko atea  
Porta con peche amortecido



Cajón con cierre amortiguado  
Drawer fitted with soft closing system  
Gaveta com sistema de corredejas com amortecedor  
Caiixos amb sistema de tancament suau  
Motelgailudun itxierazko kajoia  
Caixon con peche amortecido



Acabado melamina con textura  
Textured melamine finish  
Cor melamina com textura  
Acabat melamina amb textura  
Testuradun melanina bukatua  
Acabado melamina con textura



Fronte cajón regulable  
Adjustable front drawer  
Fronte da gaveta ajustável  
Frontal calaix regulable  
Neurrirako kajoia aurrekaldea  
Fronte do caixon axustable



Acabado lacado brillo  
High gloss lacquered finish  
Cor lacado brilho  
Acabat lacat brillant  
Distiradun lakatzuko bukatua  
Acabado lacado brillo



Guías Hettich  
Hettich drawer sliding system  
Guías Hettich  
Guies Hettich  
Hettich gidak  
Guias Hettich

Blanco  
White  
Branco  
Blanc  
Zuria  
Branco

Roble medio  
Medium oak  
Carvalho médio  
Roure mitjà  
Haritz ertainekoa  
Carballo medio

## MOON 50

Acabado	Referencia
Blanco	154 01 050
Roble medio	154 21 050

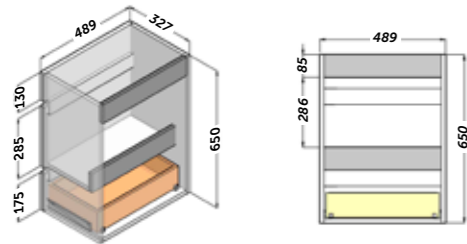

## AUXILIARES

### JOKER columna

Acabado	Referencia
Blanco	137 01 335
Roble medio	137 21 335

### JOKER colgar

Acabado	Referencia
Blanco	137 01 435
Roble medio	137 21 435

### JOKER auxiliar

Acabado	Referencia
Blanco	137 01 445
Roble medio	137 21 445

# DOMINÓ



MADE IN SPAIN

## Descripción:

- Mueble suspendido en estructura 16 mm de grueso.
- Sujeción ajustable en altura y profundidad.
- 1 puerta con cierre amortiguado.
- Fronte de 19 mm con laterales PVC efecto cristal.
- Lacado brillo.



Puerta con cierre amortiguado  
Door with soft closing system  
Porta com amortecedor  
Porta amb sistema de tancament suau  
Motelgailudun itxierazko atea  
Porta con peche amortecido



Fronte con canto efecto cristal  
Front with edge crystal effect  
Fronte com canto efeito vidro  
Frontal amb cantell efecte vidre  
Kristal efektudun ertzezko aurrekaldea  
Fronte con canto efecto cristal



Acabado lacado brillo  
High gloss lacquered finish  
Cor lacado brilho  
Acabat lacat brillant  
Distiradun lakatzuko bukatua  
Acabado lacado brillo

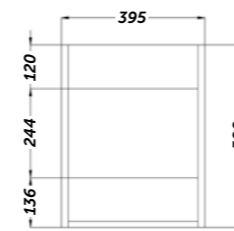
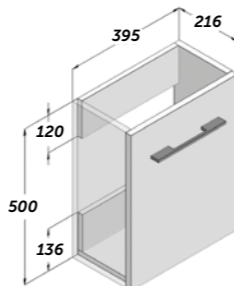

## DOMINÓ 40

Acabado	Referencia
Blanco	128 01 040
Gris	128 03 040
Negro	128 02 040

Blanco  
White  
Branco  
Blanc  
Zuria  
Branco

Gris  
Grey  
Cinzentu  
Gris  
Grisa  
Gris

Negro  
Black  
Petro  
Negre  
Zuri-beltzean  
Negro

# Especificaciones técnicas

## PEFC CERTIFICADO

Gracias a nuestro compromiso con el medio ambiente hemos obtenido la certificación PEFC para la mayoría de nuestros modelos.



## GUÍAS CAJONES

En nuestro constante esfuerzo por ofrecer la más alta calidad. Hemos incorporado el sistema de guías de marcas líderes en el mundo y sinónimo de calidad e innovación como HETTICH o GRASS.



Material fabricado para ofrecer resistencia al agua pero no previene completamente la penetración del agua ante una prolongada exposición.

Todas nuestras guías son:

- invisibles.
- con sistema de cierre amortiguado.
- silenciosas.

## CAJÓN CON ESTRUCTURA DE METAL



## CAJÓN CON ACABADO TEXTIL



## VACÍO SANITARIO

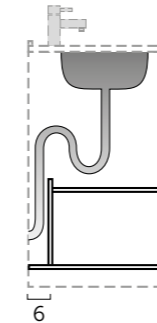

Todos nuestros muebles poseen un vacío sanitario estándar.

## BISAGRAS

Todas las puertas: Están equipadas con un sistema de cierre amortiguado.

- Son silenciosas.
- Son ajustables



## PATAS

Las patas son resistentes y ajustables en altura.



## COLGADORES



Todos nuestros muebles suspendidos están equipados con soportes con sistema anti-vuelco regulables en altura y profundidad. **Hasta 120 kg por colgador.**



Las columnas de nuestros muebles están equipadas con soportes regulables con sistema anti-vuelco y embellecedor blanco.



Los colgares están equipados con soportes regulables.



## ONIX



- Cerámica extraplana.

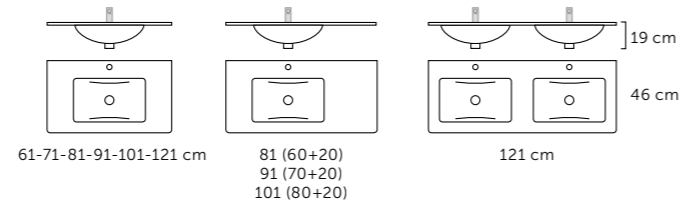

Medida	Referencia	Medida	Referencia
60	500 01 060	100	500 01 100
70	500 01 070	100 (80+20) izda.	500 01 101
80	500 01 080	120 (1 seno)	500 01 120
80 (60+20) izda.	500 01 081	120 (2 senos)	500 01 122
90	500 01 090		
90 (70+20) izda.	500 01 091		

## TOPACIO



- Resina con recubrimiento gel coat.

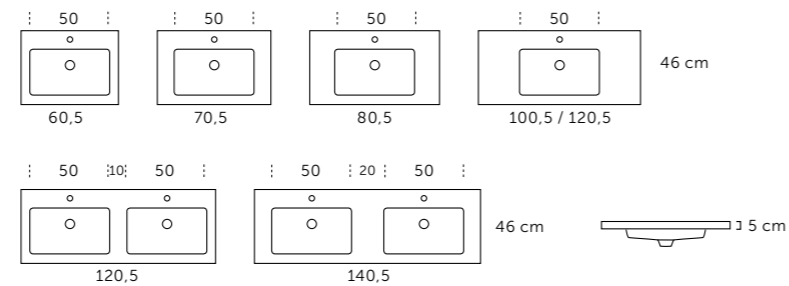

Medida	Referencia	Medida	Referencia
60	505 01 060	120 (1 washb.)	505 01 120
70	505 01 070	120 (2 washb.)	505 01 122
80	505 01 080	140 (2 washb.)	505 01 142
100	505 01 100		

## JADE



- Cristal de masa blanca.

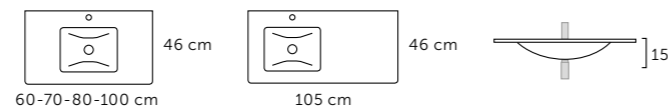

Medida	Referencia	Medida	Referencia
60	504 01 060	100	504 01 100
70	504 01 070	105 (izda.)	504 01 105
80	504 01 080	105 (dcha.)	504 01 106

## DAMA



- Cerámica extraplana con esquinas redondeadas.

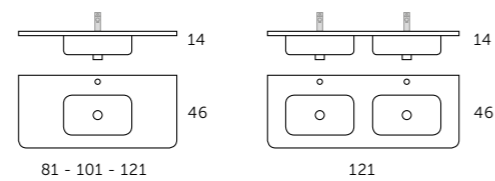

Medida	Referencia
80	503 01 080
100	503 01 100
120	503 01 120
120 (2 senos)	503 01 122

## AMBAR



- Mate solid surface.

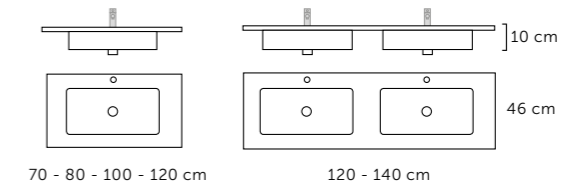

Medida	Referencia
70	506 01 070
80	506 01 080
100	506 01 100
120 (1 seno)	506 01 120
120 (2 senos)	506 01 122
140 (2 senos)	506 01 142

### AMBAR DESPLAZADO

LEFT		RIGHT	
Medida	Referencia	Medida	Referencia
80 (60+20)	506 01 081	80 (60+20)	506 01 083
90 (70+20)	506 01 092	-	-
90 (60+30)	506 01 091	90 (60+30)	506 01 093
100 (60+40)	506 01 101	100 (60+40)	506 01 103
100 (80+20)	506 01 102	-	-
105 (70+35)	506 01 105	105 (70+35)	506 01 106
110 (60+50)	506 01 111	110 (60+50)	506 01 113
120 (60+60)	506 01 121	120 (60+60)	506 01 123
140 (70+70)	506 01 143	140 (70+70)	506 01 144

## AMBAR TAPA



- Mate solid surface.

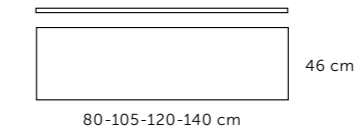

Medida	Referencia
80	508 01 080
105	508 01 105
120	508 01 120
140	508 01 140

## AMBAR LIP



- Mate solid surface.

### Opción toallero

Referencia  
524 01 999 40

Medida	Referencia
80	524 01 081
100	524 01 101
120	524 01 121

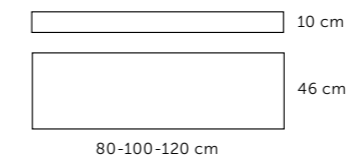

Medida	Referencia
80	524 01 080
100	524 01 100
120	524 01 120

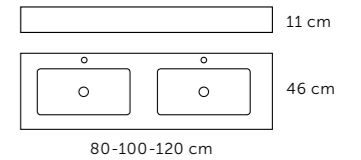

## WAVE

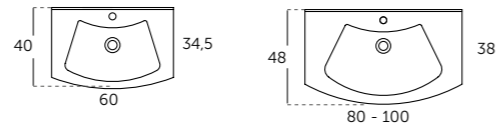

Medida	Referencia
60 x 40	516 01 060
80 x 48	516 01 080
100 x 48	516 01 100

- Resina con recubrimiento gel coat.

## SKY

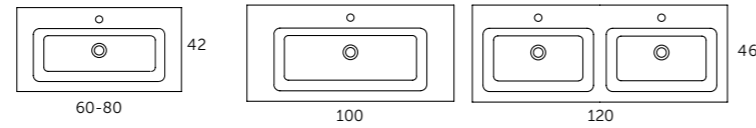

Medida	Referencia
60 x 42	517 01 060
80 x 42	517 01 080
100 x 46	517 01 100
120 x 46 (2 senos)	517 01 120

- Resina con recubrimiento gel coat.

## QUATTRO

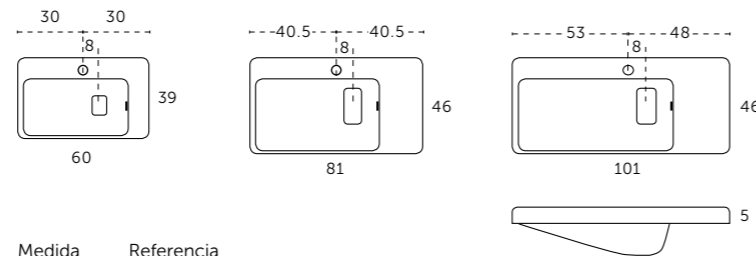

Medida	Referencia
60 x 38	520 01 060
80 x 46	520 01 080
100 x 46	520 01 100

- Cerámica brillo.

## TÍVOLI

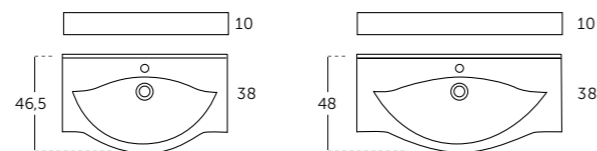

Medida	Referencia
80	513 01 080
100	513 01 100

- Cerámica brillo.

## STRIP

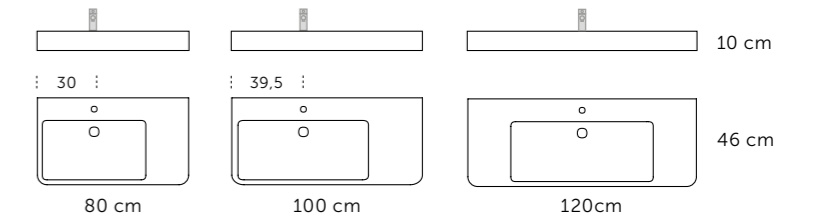

Medida	Referencia
80	593 01 080
100	593 01 100
120	593 01 120

- Carga mineral con recubrimiento gel coat mate.  
Color: Blanco grisáceo



Se puede instalar directamente a la pared con estos soportes específicos

### Soportes strip

Referencia  
410 00 190

## CRISTAL



### METALIZADO

Medida	Referencia
60 x 46	502 11 060
70 x 46	502 11 070
80 x 46	502 11 080
100 x 46	502 11 100



### NEGRO

Medida	Referencia
60 x 46	502 02 060
70 x 46	502 02 070
80 x 46	502 02 080
100 x 46	502 02 100

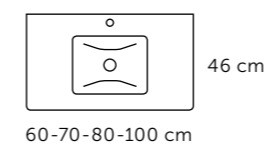

- Cristal templado de 16 mm pintado por la parte inferior.

Se desaconseja utilizar silicona en la instalación de las encimeras.

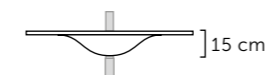

## ALBA

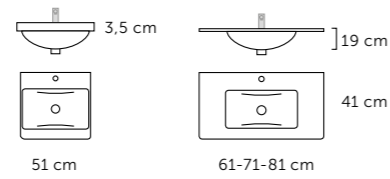

Medida	Referencia
50	510 01 080
60	510 01 060
70	510 01 070
80	510 01 080

- Cerámica brillo.

## TRESS

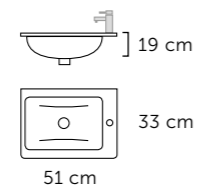

Medida	Referencia
51 x 33	529 01 050

- Resina efecto brillo.

## DOMINÓ

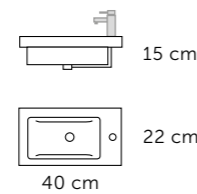

Medida	Referencia
40 x 22	528 01 040

- Resina efecto brillo.

## Encimeras y tapas

# Masai



# Encimeras MASAI



## Textura



lisa



Superficie  
tratamiento  
antibacterias



- Material: Hecho de carga mineral recubierto de poliuretano acrílico.
- Medidas disponibles: 60, 70, 80, 90, 100, 105, 120-1s, 120-2s, 140-2s.
- Colores: blanco y negro azabache en stock, resto de colores bajo pedido.
- Opción de esquinas curvas bajo pedido.
- Sin rebosadero.
- Acabado liso.



Opción de esquinas curvas

## COLORES

Blanco y Negro azabache en stock.  
Otros colores consulte plazo de entrega

### Básicos



Blanco



Gris cemento



Fango



Antracita



Beige



Moka



Tierra



Marrón metalizado



Negro metalizado



Negro azabache



Burdeos



Berenjena



Chocolate



Wengué



Morado

### Metalizados



Plata



Oro



Plomo

# Encimeras MASAI

Blanco y negro azabache en stock.  
Otros colores consulte plazo de entrega

## MASAI 60

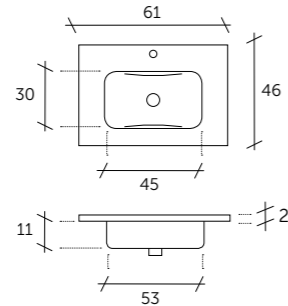

Acabado	Referencia
Blanco	518 01 060
Gris cemento	518 09 060
Fango	518 18 060
Antracita	518 03 060
Negro metalizado	518 04 060
Negro azabache	518 02 060
Burdeos	518 10 060
Beige	518 05 060
Moka	518 19 060
Tierra	518 20 060
Marrón metalizado	518 08 060
Chocolate	518 06 060
Wengué	518 07 060
Berenjena	518 11 060
Morado	518 12 060
Plata	518 15 060
Oro	518 16 060
Plomo	518 17 060

## MASAI 70

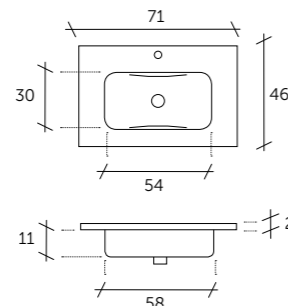

Acabado	Referencia
Blanco	518 01 070
Gris cemento	518 09 070
Fango	518 18 070
Antracita	518 03 070
Negro metalizado	518 04 070
Negro azabache	518 02 070
Burdeos	518 10 070
Beige	518 05 070
Moka	518 19 070
Tierra	518 20 070
Marrón metalizado	518 08 070
Chocolate	518 06 070
Wengué	518 07 070
Berenjena	518 11 070
Morado	518 12 070
Plata	518 15 070
Oro	518 16 070
Plomo	518 17 070

## MASAI 80

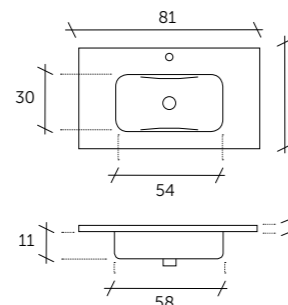

Acabado	Referencia
Blanco	518 01 080
Gris cemento	518 09 080
Fango	518 18 080
Antracita	518 03 080
Negro metalizado	518 04 080
Negro azabache	518 02 080
Burdeos	518 10 080
Beige	518 05 080
Moka	518 19 080
Tierra	518 20 080
Marrón metalizado	518 08 080
Chocolate	518 06 080
Wengué	518 07 080
Berenjena	518 11 080
Morado	518 12 080
Plata	518 15 080
Oro	518 16 080
Plomo	518 17 080

## MASAI 90

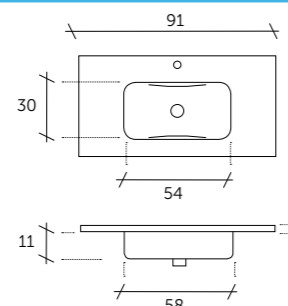

Acabado	Referencia
Blanco	518 01 090
Gris cemento	518 09 090
Fango	518 18 090
Antracita	518 03 090
Negro metalizado	518 04 090
Negro azabache	518 02 090
Burdeos	518 10 090
Beige	518 05 090
Moka	518 19 090
Tierra	518 20 090
Marrón metalizado	518 08 090
Chocolate	518 06 090
Wengué	518 07 090
Berenjena	518 11 090
Morado	518 12 090
Plata	518 15 090
Oro	518 16 090
Plomo	518 17 090

## MASAI 100

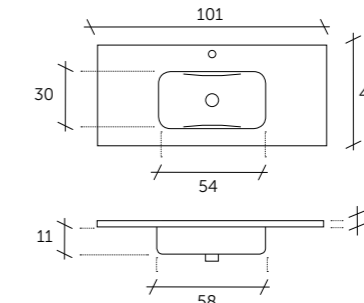

Acabado	Referencia
Blanco	518 01 100
Gris cemento	518 09 100
Fango	518 18 100
Antracita	518 03 100
Negro metalizado	518 04 100
Negro azabache	518 02 100
Burdeos	518 10 100
Beige	518 05 100
Moka	518 19 100
Tierra	518 20 100
Marrón metalizado	518 08 100
Chocolate	518 06 100
Wengué	518 07 100
Berenjena	518 11 100
Morado	518 12 100
Plata	518 15 100
Oro	518 16 100
Plomo	518 17 100

## MASAI 105

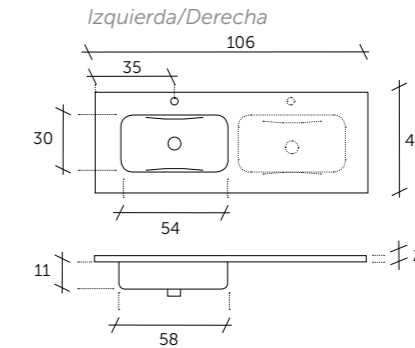

Acabado	Referencia
Blanco	518 01 105
Gris cemento	518 09 105
Fango	518 18 105
Antracita	518 03 105
Negro metalizado	518 04 105
Negro azabache	518 02 105
Burdeos	518 10 105
Beige	518 05 105
Moka	518 19 105
Tierra	518 20 105
Marrón metalizado	518 08 105
Chocolate	518 06 105
Wengué	518 07 105
Berenjena	518 11 105
Morado	518 12 105
Plata	518 15 105
Oro	518 16 105
Plomo	518 17 105

## MASAI 120

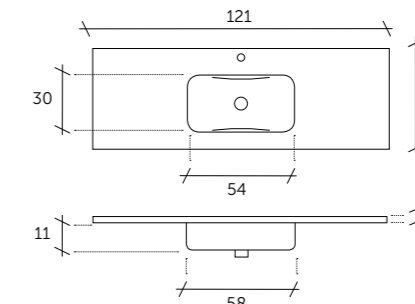

Acabado	Referencia
Blanco	518 01 120
Gris cemento	518 09 120
Fango	518 18 120
Antracita	518 03 120
Negro metalizado	518 04 120
Negro azabache	518 02 120
Burdeos	518 10 120
Beige	518 05 120
Moka	518 19 120
Tierra	518 20 120
Marrón metalizado	518 08 120
Chocolate	518 06 120
Wengué	518 07 120
Berenjena	518 11 120
Morado	518 12 120
Plata	518 15 120
Oro	518 16 120
Plomo	518 17 120

## MASAI 120 2 senos

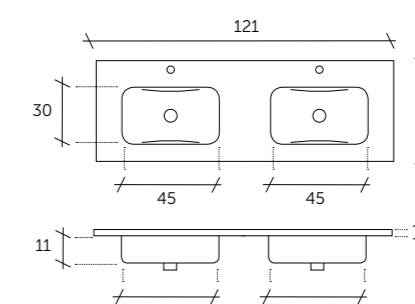
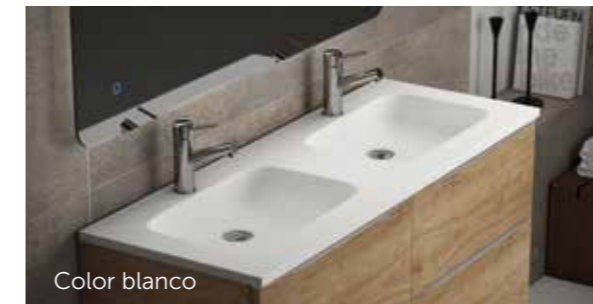

Acabado	Referencia
Blanco	518 01 122
Gris cemento	518 09 122
Fango	518 18 122
Antracita	518 03 122
Negro metalizado	518 04 122
Negro azabache	518 02 122
Burdeos	518 10 122
Beige	518 05 122
Moka	518 19 122
Tierra	518 20 122
Marrón metalizado	518 08 122
Chocolate	518 06 122
Wengué	518 07 122
Berenjena	518 11 122
Morado	518 12 122
Plata	518 15 122
Oro	518 16 122
Plomo	518 17 122

## MASAI 140 2 senos

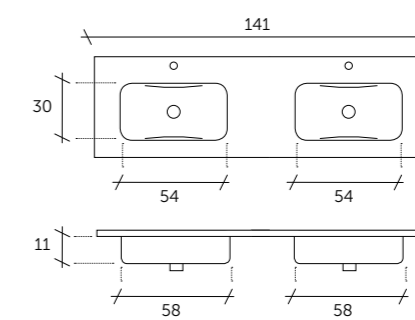

Acabado	Referencia
Blanco	518 01 142
Gris cemento	518 09 142
Fango	518 18 142
Antracita	518 03 142
Negro metalizado	518 04 142
Negro azabache	518 02 142
Burdeos	518 10 142
Beige	518 05 142
Moka	518 19 142
Tierra	518 20 142
Marrón metalizado	518 08 142
Chocolate	518 06 142
Wengué	518 07 142
Berenjena	518 11 142
Morado	518 12 142
Plata	518 15 142
Oro	518 16 142
Plomo	518 17 142

# Tapas MASAI

Bajo pedido. Consulte plazo de entrega.



## COLORES

### Básico



### Metalizados



## ACABADOS



- 2 cm altura
- Hecho de carga mineral recubierto de poliuretano acrílico.
- Liso y pizarra suave como opciones de textura.
- Se entregan sin agujero. Fácilmente perforable con una broca de corona para carpintería de madera.



Superficie tratamiento antibacterias

## TAPA MASAI

○ Blanco		● Gris cemento		● Fango		● Antracita		● Negro metalizado		● Negro azabache	
cm	Referencia	cm	Referencia	cm	Referencia	cm	Referencia	cm	Referencia	cm	Referencia
Masai 60	519 01 060	Masai 60	519 09 060	Masai 60	519 18 060	Masai 60	519 03 060	Masai 60	519 04 060	Masai 60	519 02 060
Masai 70	519 01 070	Masai 70	519 09 070	Masai 70	519 18 070	Masai 70	519 03 070	Masai 70	519 04 070	Masai 70	519 02 070
Masai 80	519 01 080	Masai 80	519 09 080	Masai 80	519 18 080	Masai 80	519 03 080	Masai 80	519 04 080	Masai 80	519 02 080
Masai 90	519 01 090	Masai 90	519 09 090	Masai 90	519 18 090	Masai 90	519 03 090	Masai 90	519 04 090	Masai 90	519 02 090
Masai 100	519 01 100	Masai 100	519 09 100	Masai 100	519 18 100	Masai 100	519 03 100	Masai 100	519 04 100	Masai 100	519 02 100
Masai 105	519 01 105	Masai 105	519 09 105	Masai 105	519 18 105	Masai 105	519 03 105	Masai 105	519 04 105	Masai 105	519 02 105
Masai 120	519 01 120	Masai 120	519 09 120	Masai 120	519 18 120	Masai 120	519 03 120	Masai 120	519 04 120	Masai 120	519 02 120
Masai 140	519 01 140	Masai 140	519 09 140	Masai 140	519 18 140	Masai 140	519 03 140	Masai 140	519 04 140	Masai 140	519 02 140
Masai 150	519 01 150	Masai 150	519 09 150	Masai 150	519 18 150	Masai 150	519 03 150	Masai 150	519 04 150	Masai 150	519 02 150
Masai 160	519 01 160	Masai 160	519 09 160	Masai 160	519 18 160	Masai 160	519 03 160	Masai 160	519 04 160	Masai 160	519 02 160
Masai 180	519 01 180	Masai 180	519 09 180	Masai 180	519 18 180	Masai 180	519 03 180	Masai 180	519 04 180	Masai 180	519 02 180
Masai 200	519 01 200	Masai 200	519 09 200	Masai 200	519 18 200	Masai 200	519 03 200	Masai 200	519 04 200	Masai 200	519 02 200

● Beige		● Moka		● Tierra		● Marrón metalizado		● Chocolate		● Wengué	
cm	Referencia	cm	Referencia	cm	Referencia	cm	Referencia	cm	Referencia	cm	Referencia
Masai 60	519 05 060	Masai 60	519 19 060	Masai 60	519 20 060	Masai 60	519 08 060	Masai 60	519 06 060	Masai 60	519 07 060
Masai 70	519 05 070	Masai 70	519 19 070	Masai 70	519 20 070	Masai 70	519 08 070	Masai 70	519 06 070	Masai 70	519 07 070
Masai 80	519 05 080	Masai 80	519 19 080	Masai 80	519 20 080	Masai 80	519 08 080	Masai 80	519 06 080	Masai 80	519 07 080
Masai 90	519 05 090	Masai 90	519 19 090	Masai 90	519 20 090	Masai 90	519 08 090	Masai 90	519 06 090	Masai 90	519 07 090
Masai 100	519 05 100	Masai 100	519 19 100	Masai 100	519 20 100	Masai 100	519 08 100	Masai 100	519 06 100	Masai 100	519 07 100
Masai 105	519 05 105	Masai 105	519 19 105	Masai 105	519 20 105	Masai 105	519 08 105	Masai 105	519 06 105	Masai 105	519 07 105
Masai 120	519 05 120	Masai 120	519 19 120	Masai 120	519 20 120	Masai 120	519 08 120	Masai 120	519 06 120	Masai 120	519 07 120
Masai 140	519 05 140	Masai 140	519 19 140	Masai 140	519 20 140	Masai 140	519 08 140	Masai 140	519 06 140	Masai 140	519 07 140
Masai 150	519 05 150	Masai 150	519 19 150	Masai 150	519 20 150	Masai 150	519 08 150	Masai 150	519 06 150	Masai 150	519 07 150
Masai 160	519 05 160	Masai 160	519 19 160	Masai 160	519 20 160	Masai 160	519 08 160	Masai 160	519 06 160	Masai 160	519 07 160
Masai 180	519 05 180	Masai 180	519 19 180	Masai 180	519 20 180	Masai 180	519 08 180	Masai 180	519 06 180	Masai 180	519 07 180
Masai 200	519 05 200	Masai 200	519 19 200	Masai 200	519 20 200	Masai 200	519 08 200	Masai 200	519 06 200	Masai 200	519 07 200

● Burdeos		● Berenjena		● Morado		● Plata		● Oro		● Plomo	
cm	Referencia	cm	Referencia	cm	Referencia	cm	Referencia	cm	Referencia	cm	Referencia
Masai 60	519 10 060	Masai 60	519 11 060	Masai 60	519 12 060	Masai 60	519 15 060	Masai 60	519 16 060	Masai 60	519 17 060
Masai 70	519 10 070	Masai 70	519 11 070	Masai 70	519 12 070	Masai 70	519 15 070	Masai 70	519 16 070	Masai 70	519 17 070
Masai 80	519 10 080	Masai 80	519 11 080	Masai 80	519 12 080	Masai 80	519 15 080	Masai 80	519 16 080	Masai 80	519 17 080
Masai 90	519 10 090	Masai 90	519 11 090	Masai 90	519 12 090	Masai 90	519 15 090	Masai 90	519 16 090	Masai 90	519 17 090
Masai 100	519 10 100	Masai 100	519 11 100	Masai 100	519 12 100	Masai 100	519 15 100	Masai 100	519 16 100	Masai 100	519 17 100
Masai 105	519 10 105	Masai 105	519 11 105	Masai 105	519 12 105	Masai 105	519 15 105	Masai 105	519 16 105	Masai 105	519 17 105
Masai 120	519 10 120	Masai 120	519 11 120	Masai 120	519 12 120	Masai 120	519 15 120	Masai 120	519 16 120	Masai 120	519 17 120
Masai 140	519 10 140	Masai 140	519 11 140	Masai 140	519 12 140	Masai 140	519 15 140	Masai 140	519 16 140	Masai 140	519 17 140
Masai 150	519 10 150	Masai 150	519 11 150	Masai 150	519 12 150	Masai 150	519 15 150	Masai 150	519 16 150	Masai 150	519 17 150
Masai 160	519 10 160	Masai 160	519 11 160	Masai 160	519 12 160	Masai 160	519 15 160	Masai 160	519 16 160	Masai 160	519 17 160
Masai 180	519 10 180	Masai 180	519 11 180	Masai 180	519 12 180	Masai 180	519 15 180	Masai 180	519 16 180	Masai 180	519 17 180
Masai 200	519 10 200	Masai 200	519 11 200	Masai 200	519 12 200	Masai 200	519 15 200	Masai 200	519 16 200	Masai 200	519 17 200

# LAVABOS sobreponer

## CERDEÑA

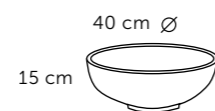

cm Referencia  
40 507 01 040

- Cerámica brillo dos caras.

## SOMAOZ

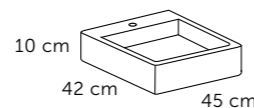

cm Referencia  
45 x 42 507 01 045

- Cerámica brillo.

## OVAL



cm Referencia  
58 x 42 509 01 001

- Solid surface mate

## LANDES



FFC<sup>+</sup>PLUS

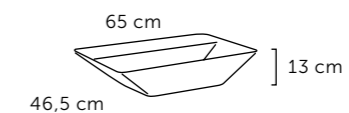

cm Referencia  
46.5 x 65 507 01 002

- Cerámica brillo.

## ROTTERDAM



FFC<sup>+</sup>PLUS

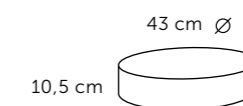

cm Referencia  
43 507 01 004

- Cerámica brillo.

## AMBERES



FFC<sup>+</sup>PLUS

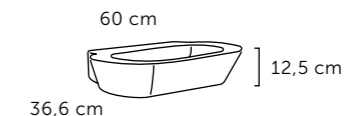

cm Referencia  
36.6 x 60 507 01 003

- Cerámica brillo.

## ESTAMBUL



FFC<sup>+</sup>PLUS

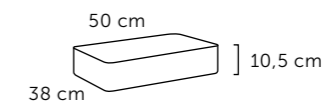

cm Referencia  
50 x 38 507 01 005

- Cerámica brillo.

# ESPEJOS

## MOON

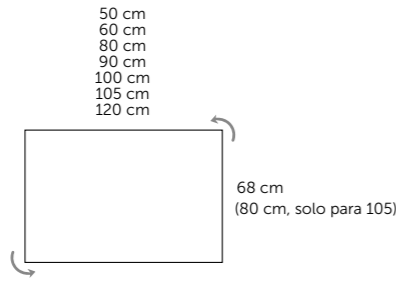

- Grosor cristal: 4 mm
- Sobre base: No
- Colgaderos: 4
- Reversible: Si

cm	Referencia
50x68	200 00 050
60x68	200 00 060
80x68	200 00 080
90x68	200 00 090
100x68	200 00 100
105x80	200 00 105
120x68	200 00 120

## CLOUD

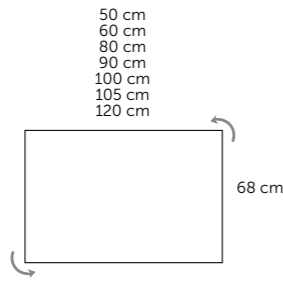

- Grosor cristal: 4 mm
- Sobre base en tablero de partículas de 16 mm.
- Colgaderos: 4
- Reversible: Si

cm	Referencia
50x68	205 00 050
60x68	205 00 060
80x68	205 00 080
90x68	205 00 090
100x68	205 00 100
120x68	205 00 120

## SIGMA

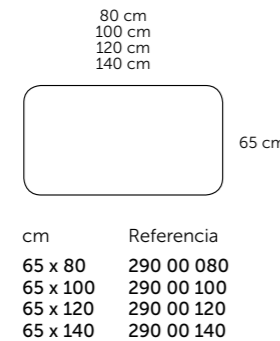

- Grosor cristal: 5 mm
- Sobre base en tablero de partículas de 16 mm.
- Reversible: No

cm	Referencia
65 x 80	290 00 080
65 x 100	290 00 100
65 x 120	290 00 120
65 x 140	290 00 140

## TOOL

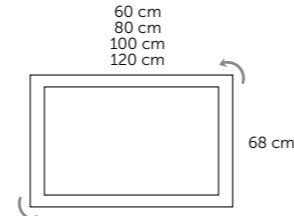

Para los muebles de 70 es posible utilizar las medidas 60x68 y 80x68 giradas.

- Grosor cristal: 3 mm
- Sobre base en tablero de partículas de 16 mm en melamina texturada o DM lacado.
- Colgaderos: 4
- Reversible: Si.

Blanco		Roble medio	
cm	Referencia	cm	Referencia
60 x 68	207 01 060	60 x 68	207 21 060
80 x 68	207 01 080	80 x 68	207 21 080
100 x 68	207 01 100	100 x 68	207 21 100
120 x 68	207 01 120	120 x 68	207 21 120

Gris		Roble natural	
cm	Referencia	cm	Referencia
60 x 68	207 03 060	60 x 68	207 24 060
80 x 68	207 03 080	80 x 68	207 24 080
100 x 68	207 03 100	100 x 68	207 24 100
120 x 68	207 03 120	120 x 68	207 24 120

## NITRO

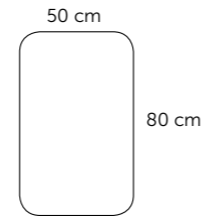

- Grosor cristal: 5 mm
- Colgaderos: 2
- Reversible: No

cm	Referencia
50 x 80	241 00 050

## TAO

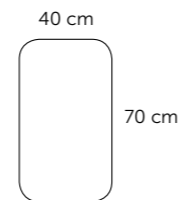

- Grosor cristal: 5 mm
- Colgaderos: 2
- Reversible: No

cm	Referencia
40 x 70	240 00 040

## REDONDO

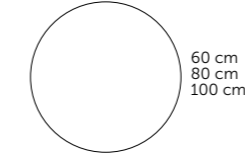

- Grosor cristal: 4 mm
- Sobre base: No
- Colgaderos: 2
- Reversible: No

cm	Referencia
60	244 00 060
80	244 00 080
100	244 00 100

## OBLONGO

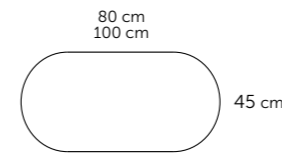

- Grosor cristal: 5 mm
- Sobre base en tablero de partículas de 16 mm.
- Colgaderos: 2
- Reversible: No

cm	Referencia
45 x 80	291 00 082
45 x 100	291 00 102

## TRENT

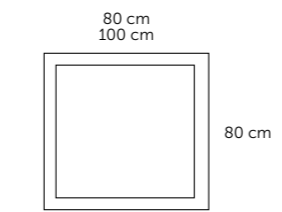

Blanco mate		Gris mate	
cm	Referencia	cm	Referencia
80 x 80	295 01 080	80 x 80	295 03 080
80 x 100	295 01 100	80 x 100	295 03 100

## REDONDO STRIP

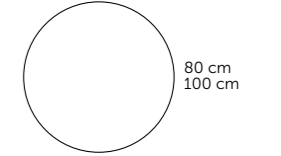

- Grosor cristal: 4 mm
- Sobre base en tablero de partículas de 16 mm.
- Colgaderos: 2
- Reversible: No

cm	Referencia
80	291 00 081
100	291 00 101

## STRIP

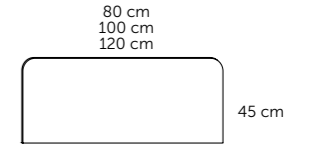

- Grosor cristal: 5 mm
- Sobre base en tablero de partículas de 16 mm.
- Colgaderos: 2
- Reversible: No
- Estante no incluido

cm	Referencia
60 x 80	291 00 080
60 x 100	291 00 100
60 x 120	291 00 120

## STRIP CENTRAL

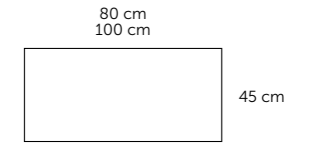

- Grosor cristal: 4 mm
- Sobre base en tablero de partículas de 19 mm.
- Estante no incluido

cm	Referencia
45 x 80	291 00 083
45 x 100	291 00 103



# ESPEJOS

## LED LIGHT

### SPOTY



Sistema antivaho  
Anti fog system  
Sistema anti-vapor  
Sistema antiabaf  
Lurrunaren kontrako sistema  
Sistema antivaho



Luz ambiental  
Ambient light  
Luz ambiente  
Llum ambiental  
Giro-argia  
Luz ambiental



Reproductor musical integrado, con conexión bluetooth. 2 altavoces de 3 w cada uno.  
Built in music player, bluetooth connection. 2 speakers of 3W each.  
Reproductor musical integrado, con conexión bluetooth 2 altavoces de 3 w cada um.  
Reproductor musical integrat, amb connexió bluetooth. 2 altaveus de 3 w cadascú.  
Musika erreproduzitzaila integratua, bluetooth konexioarekin. 3w-dun bi bozgorailu.  
Reproductor musical integrado, con conexión bluetooth. 2 altavoces de 3 w cada un.



Sensor de contacto On/ Off  
Contact sensor On/ Off  
Sensor interruptor On/ Off  
Sensor de contacte On/ Off  
On/Off kontaktu sensorea  
Sensor de contacto On/ Off



Reloj digital  
Digital clock  
Relogio digital  
Rellotge digital  
Erlotzu digitala  
Reloxo dixital

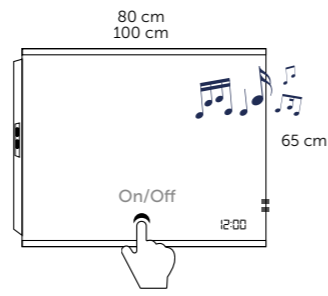

- Grosor cristal: 5 mm
- Zona Antivaho: Si
- On/Off: Sensor táctil
- Iluminación: 2 tiras luminosas LED
- Reversible: No
- Protección: IP44
- Reloj digital: Si
- Reproductor musical: 2 Altavoces de 3W cada uno.

cm	Referencia
80x65	267 00 080
100x65	267 00 100

### ORACLE



Sistema antivaho  
Anti fog system  
Sistema anti-vapor  
Sistema antiabaf  
Lurrunaren kontrako sistema  
Sistema antivaho



Sensor de contacto On/ Off  
Contact sensor On/ Off  
Sensor interruptor On/ Off  
Sensor de contacte On/ Off  
On/Off kontaktu sensorea  
Sensor de contacto On/ Off



Lupa aumento x3  
Magnifying zoom in Mirror  
Lupa aumento 3x  
Lupa augment x3  
3x-eko handiagotze lupa  
Lupa aumento x3

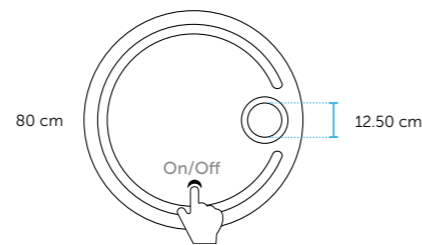

- Grosor cristal: 5 mm
- Zona Antivaho: Si
- On/Off: Sensor táctil
- Iluminación: Luz LED maquillaje
- Reversible: No
- Protección: IP44
- Lupa: aumento x3

cm	Referencia
80	260 00 080

### FRAME



Sistema antivaho  
Anti fog system  
Sistema anti-vapor  
Sistema antiabaf  
Lurrunaren kontrako sistema  
Sistema antivaho



Sensor de contacto On/ Off  
Contact sensor On/ Off  
Sensor interruptor On/ Off  
Sensor de contacte On/ Off  
On/Off kontaktu sensorea  
Sensor de contacto On/ Off



Luz ambiental  
Ambient light  
Luz ambiente  
Llum ambiental  
Giro-argia  
Luz ambiental



Reversible  
It is reversible  
Reversibel  
Reversibel  
Itzulgarria  
Reversibile

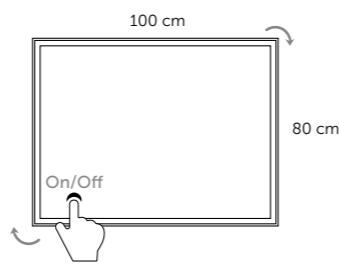

- Grosor cristal: 5 mm
- Zona Antivaho: Si
- On/Off: Sensor táctil
- Iluminación: Luz LED perimetral
- Reversible: Si
- Protección: IP44

cm	Referencia
100x80	266 00 100

### CEBRA



Sistema antivaho  
Anti fog system  
Sistema anti-vapor  
Sistema antiabaf  
Lurrunaren kontrako sistema  
Sistema antivaho



Sensor de contacto On/ Off  
Contact sensor On/ Off  
Sensor interruptor On/ Off  
Sensor de contacte On/ Off  
On/Off kontaktu sensorea  
Sensor de contacto On/ Off



Luz ambiental  
Ambient light  
Luz ambiente  
Llum ambiental  
Giro-argia  
Luz ambiental



Reversible  
It is reversible  
Reversibel  
Reversibel  
Itzulgarria  
Reversibile

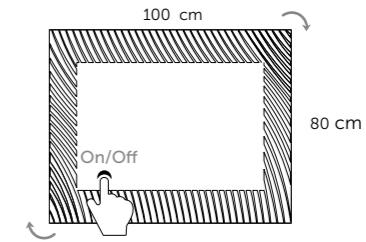

- Grosor cristal: 5 mm
- Zona Antivaho: Si
- On/Off: Sensor táctil
- Iluminación: luz LED ambiente
- Reversible: Si
- Protección: IP44

cm	Referencia
100x80	265 00 100

### HOLMES



Sistema antivaho  
Anti fog system  
Sistema anti-vapor  
Sistema antiabaf  
Lurrunaren kontrako sistema  
Sistema antivaho



Sensor de contacto On/ Off  
Contact sensor On/ Off  
Sensor interruptor On/ Off  
Sensor de contacte On/ Off  
On/Off kontaktu sensorea  
Sensor de contacto On/ Off



Reloj digital  
Digital clock  
Relogio digital  
Rellotge digital  
Erlotzu digitala  
Reloxo dixital



Lupa aumento x3  
Magnifying zoom in Mirror  
Lupa aumento 3x  
Lupa augment x3  
3x-eko handiagotze lupa  
Lupa aumento x3

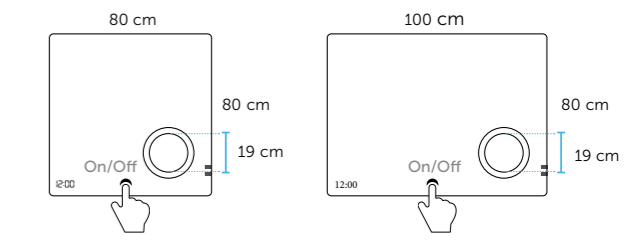

- Grosor cristal: 5 mm
- Zona Antivaho: Si
- On/Off: Sensor táctil
- Iluminación: luz LED maquillaje
- Reversible: No
- Protección: IP44
- Lupa: aumento x3
- Reloj digital: Si

cm	Referencia
80 x 80	263 00 080
100 x 80	263 00 100

### TOWER



Sistema antivaho  
Anti fog system  
Sistema anti-vapor  
Sistema antiabaf  
Lurrunaren kontrako sistema  
Sistema antivaho



Sensor infrarrojo On/Off  
Infrared sensor On/Off  
Sensor infravermelho On/ Off  
Sensor infraroi On/ Off  
On/Off sensore infragorria  
Sensor infravermello On/Off



Reversible  
It is reversible  
Reversibel  
Reversibel  
Itzulgarria  
Reversibile

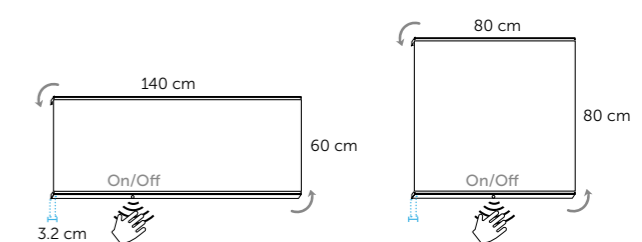

- Grosor cristal: 5 mm
- Zona Antivaho: Si
- On/Off: Sensor infrarrojo
- Iluminación: 2 tiras luminosas LED
- Reversible: Si
- Protección: IP44

cm	Referencia
80x80	262 00 080
140x60	262 00 140

# ESPEJOS

## LED LIGHT

### STONE



cm Referencia  
80 x 80 261 00 080

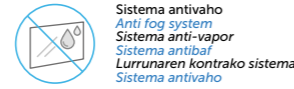

Sistema antivaho  
Anti fog system  
Sistema anti-vapor  
Sistema antibaf  
Lurrunaren kontrako sistema  
Sistema antivaho



Sensor de contacto On/ Off  
Contact sensor On/ Off  
Sensor interruptor On/ Off  
Sensor de contacte On/ Off  
On/Off kontaktu sentorea  
Sensor de contacto On/ Off



Lupa aumento x3  
Magnifying zoom in Mirror  
Lupa aumento 3x  
Lupa augment x3  
3x-eko haundiagotze lupa  
Lupa aumento x3

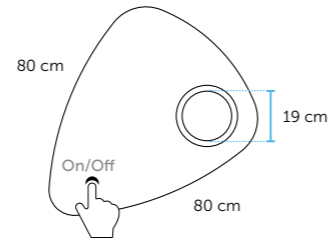

- Grosor cristal: 5 mm
- Zona Antivaho: Si
- On/Off: Sensor táctil
- Iluminación: luz LED maquillaje
- Reversible: No
- Protección: IP44
- Lupa: aumento x3

### MILÁN



cm Referencia  
80x70 268 00 080



Sistema antivaho  
Anti fog system  
Sistema anti-vapor  
Sistema antibaf  
Lurrunaren kontrako sistema  
Sistema antivaho



Reversible  
It is reversible  
Reversibel  
Reversible  
Itzulgarria  
Reversible

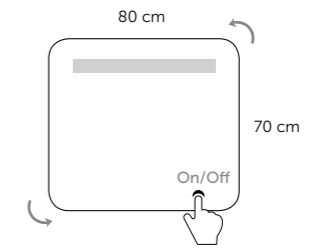

- Grosor cristal: 5 mm
- Zona Antivaho: No
- On/Off: Sensor táctil
- Iluminación: 1 tira luminosa LED
- Reversible: Si
- Protección: IP44

### MÓDENA



cm Referencia  
80x65 264 00 080  
100x65 264 00 100



Sistema antivaho  
Anti fog system  
Sistema anti-vapor  
Sistema antibaf  
Lurrunaren kontrako sistema  
Sistema antivaho



Sensor de contacto On/ Off  
Contact sensor On/ Off  
Sensor interruptor On/ Off  
Sensor de contacte On/ Off  
On/Off kontaktu sentorea  
Sensor de contacto On/ Off



Luz ambiental  
Ambient light  
Luz ambiente  
Llum ambiental  
Giro-argia  
Luz ambiental



Reversible  
It is reversible  
Reversibel  
Reversible  
Itzulgarria  
Reversible

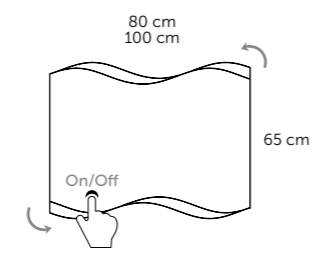

- Grosor cristal: 5 mm
- Zona Antivaho: Si
- On/Off: Sensor táctil
- Iluminación: luz LED ambiente
- Reversible: Si
- Protección: IP44

### RAIN



cm Referencia  
80x60 269 00 060  
80x80 269 00 080  
80x100 269 00 100  
80x120 269 00 120

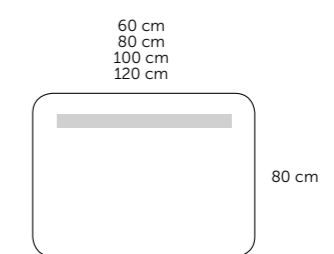

- Grosor cristal: 5 mm
- Zona Antivaho: No
- Iluminación: 1 tira luminosa LED
- Reversible: No
- Protección: IP44

### VERONA



cm Referencia  
80x60 246 00 060  
100x80 246 00 100



Sistema antivaho  
Anti fog system  
Sistema anti-vapor  
Sistema antibaf  
Lurrunaren kontrako sistema  
Sistema antivaho



Sensor de contacto On/ Off  
Contact sensor On/ Off  
Sensor interruptor On/ Off  
Sensor de contacte On/ Off  
On/Off kontaktu sentorea  
Sensor de contacto On/ Off



Luz ambiental  
Ambient light  
Luz ambiente  
Llum ambiental  
Giro-argia  
Luz ambiental



Reversible  
It is reversible  
Reversibel  
Reversible  
Itzulgarria  
Reversible

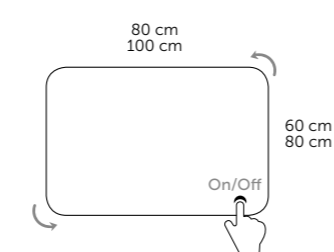

- Grosor cristal: 5 mm
- Zona Antivaho: Si
- On/Off: Sensor táctil
- Iluminación: luz LED ambiente
- Reversible: Si
- Protección: IP44

# CAMERINOS

## SKYLINE



- Puertas espejo doble cara
- Double-faced mirrored door
- Espelho de dois lados
- Mirall doble cara
- Bi aldeko ispilua
- Espello dobre cara



- Estantes de cristal
- Glass shelves
- Prateleiras de vidro
- Prestatges de vidre
- Beirazko apalak
- Baldas de vidro



- Interruptor y enchufe
- Socket / On-off switch
- Interruptor eléctrico e ficha
- Interruptor i endoll
- Aldatzeko eta konektatzeko
- Interruptor e enchufe



## Apliques opcionales para SKYLINE



### Aplique SKYLINE LED Bluetooth



cm	Referencia
60	400 00 511
80	400 00 521
100	400 00 531
120	400 00 541

IP44

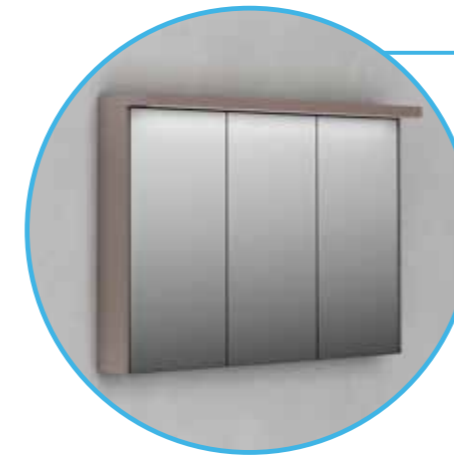

### Cornisa SKYLINE LED



Acabado	60 cm Referencia	80 cm Referencia	100 cm Referencia	120 cm Referencia
Blanco	341 01 061	341 01 081	341 01 101	341 01 121
Gris	341 03 061	341 03 081	341 03 101	341 03 121
Moka	341 16 061	341 16 081	341 16 101	341 16 121
Roble natural	341 24 061	341 24 081	341 24 101	341 24 121
Aluminio	341 11 061	341 11 081	341 11 101	341 11 121

IP44

### SKYLINE 60

Acabado	Referencia
Blanco	341 01 060
Gris	341 03 060
Moka	341 16 060
Roble natural	341 24 060
Aluminio	341 11 060

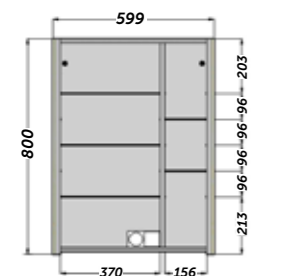
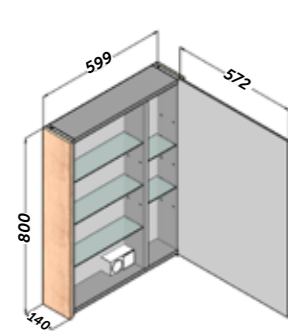

### SKYLINE 80

Acabado	Referencia
Blanco	341 01 080
Gris	341 03 080
Moka	341 06 080
Roble natural	341 24 080
Aluminio	341 11 080

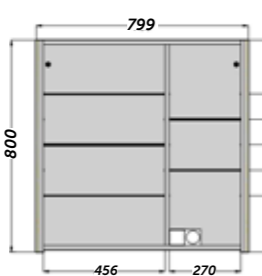
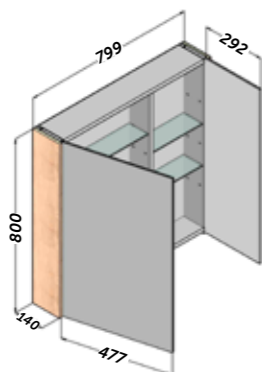

### SKYLINE 100

Acabado	Referencia
Blanco	341 01 100
Gris	341 03 100
Moka	341 16 100
Roble natural	341 24 100
Aluminio	341 11 100

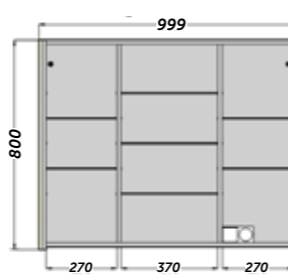
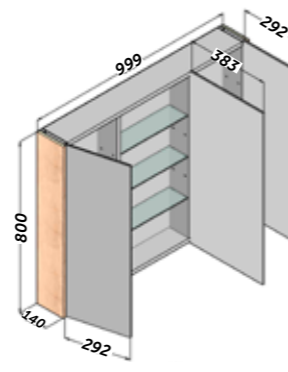

### SKYLINE 120

Acabado	Referencia
Blanco	341 01 120
Gris	341 03 120
Moka	341 16 120
Roble natural	341 24 120
Aluminio	341 11 120

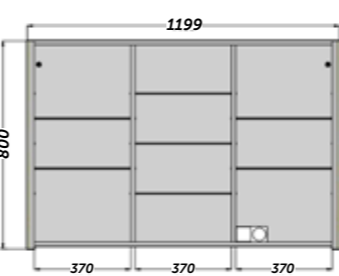
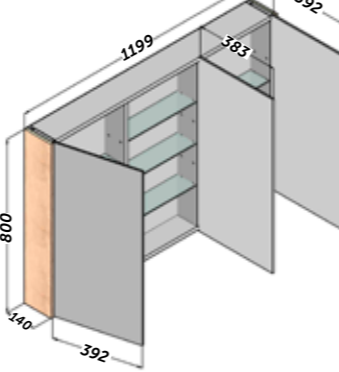

## Apliques



ESTHER LED	SOFIA LED	AINHOA LED
Referencia 400 00 121	Referencia 400 00 141	Referencia 400 00 151
luz fría	luz fría	luz fría
400 00 221	400 00 241	
luz cálida	luz cálida	

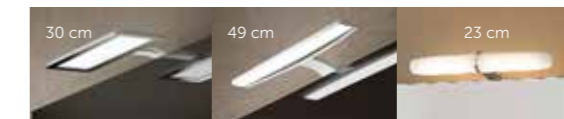

NIKITA LED	NAYRA LED	EVA LED
Referencia 400 01 171	Referencia 400 00 181	Referencia 400 00 011
luz fría	luz fría	

IP44

## DOMINÓ



### DOMINÓ 40

Acabado	Referencia
Blanco	328 01 040
Aluminio	328 14 040

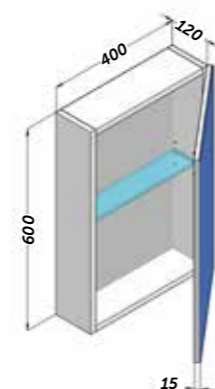

## FLASH



- Grosor Cristal: 3 mm
- Montado en puerta de 12 mm
- Colgaderos: 2 regulables
- Reversible: Si, cambiando puerta
- 1 puerta sin tirador
- Estantes de cristal



- Grosor Cristal: 3 mm
- Montado en puerta de 12 mm
- Colgaderos: 2 regulables
- Reversible: Si, cambiando puerta
- 2 puertas sin tirador
- Estantes de cristal

### FLASH 60

Acabado	Referencia
Aluminio	340 11 060

### FLASH 70

Acabado	Referencia
Aluminio	340 11 070

### FLASH 80

Acabado	Referencia
Aluminio	340 11 080

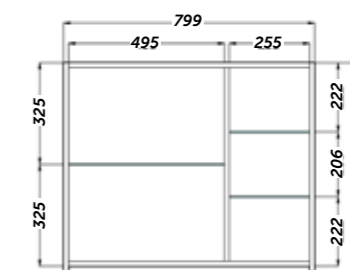
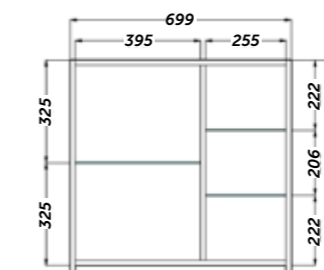
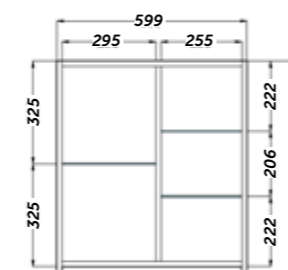
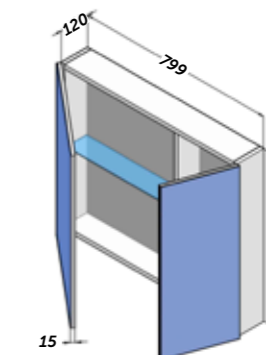
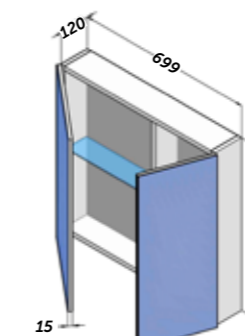
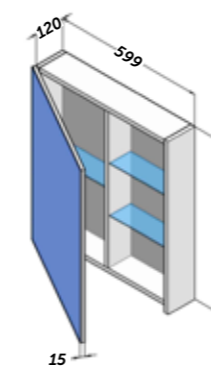

# APLIQUES

## NEREA MATE

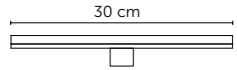

### Información técnica

IP44 5.5w 350 lumens



LED Lámpara incluida  
ABS

Kelvin Referencia  
6000 400 14 161  
luz fría

## ESTHER

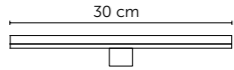

### Información técnica

IP44 5w 400 lumens

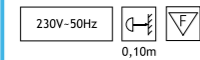

LED Lámpara incluida

Kelvin Referencia  
6000 400 00 121  
luz fría  
3000 400 00 221  
luz cálida

## SOFIA

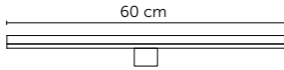

### Información técnica

IP44 6.5w 600 lumens

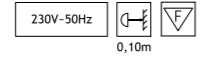

LED Lámpara incluida

Kelvin Referencia  
6000 400 00 141  
luz fría  
3000 400 00 241  
luz cálida

## AINHOA

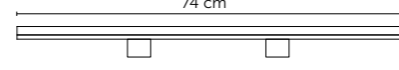

### Información técnica

IP44 12w 800 lumens

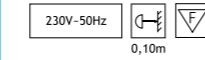

LED Lámpara incluida

Kelvin Referencia  
6000 400 00 151  
luz fría

## NIKITA

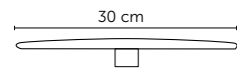

### Información técnica

IP44 10 w 1870 lumens

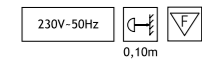

LED Lámpara incluida

Kelvin Referencia  
5700 400 01 171  
luz fría

## NAYRA BLANCO

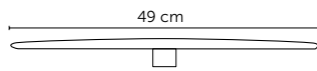

### Información técnica

IP44 6 w 780 lumens

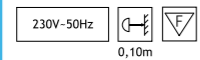

LED Lámpara incluida

Kelvin Referencia  
5700 400 00 181  
luz fría

## EVA

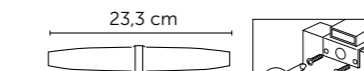

### Información técnica

IP44 6 w

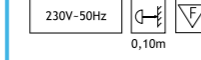

LED Lámpara incluida

Kelvin Referencia  
4000 400 00 011

## URSA para interior columnas



### Información técnica

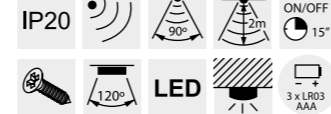

0.42 w 42 lumens  
Lámpara incluida

Kelvin Referencia  
7000 400 00 600  
luz fría

## INSTALACIÓN

Transformador incluido en el interior del aplique

NEREA, ESTHER, SOFIA, AINHOA

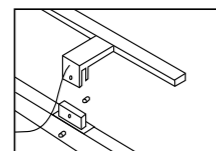

Marco de madera

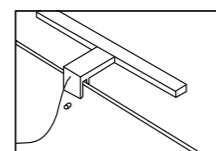

Espejo

# COMPLEMENTOS

## SOPORTES



JUEGO soporte encimera cristal

Referencia  
410 00 001



CONJUNTO soportes con sifón y válvula

Referencia  
410 00 002



Se desaconseja utilizar silicona en la instalación de las encimeras. Aconsejamos la utilización de nuestro Kit de cinta doble cara.

KIT DE CINTA

Referencia  
414 00 001

## SIFONES



JUEGO sifón cromado con válvula

Referencia  
410 00 101

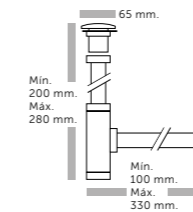

## VÁLVULAS



Válvula universal CLIC CLAC

Referencia  
51601



recomendado para encimeras de cristal

Válvula sin rebosadero

Referencia  
410 00 202



Válvula blanca

Referencia  
410 01 203

## PATAS



JUEGO 4 PATAS

Referencia  
412 00 227



JUEGO 4 PATAS

Referencia  
412 00 120



JUEGO 4 PATAS

Referencia  
412 00 050

## TOALLERO



Toallero lateral

Referencia  
416 00 001  
Cromo

## ACABADO LACADO MATE

### Blanco mate

Matte white / Bianco opaco / Branco mate / Blanc mate / Zuri matea / Branco mate

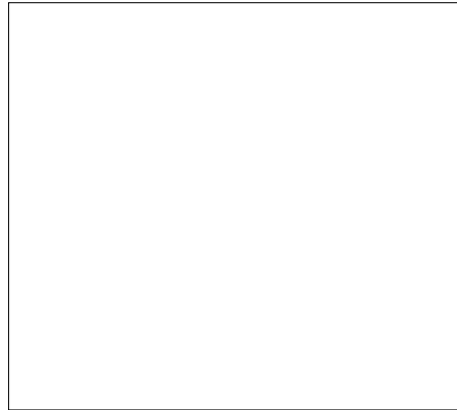

SERIE: SIGMA

### Gris intenso mate

Matte dark grey / Cinzento intenso mate / Gris intens mat / Gris mate bizia / Gris intenso mate



SERIES: STRIP / SIGMA

### Gris suave mate

Matte light grey / Cinzento suave mate / Gris suau mat / Gris mate leuna / Gris suave mate

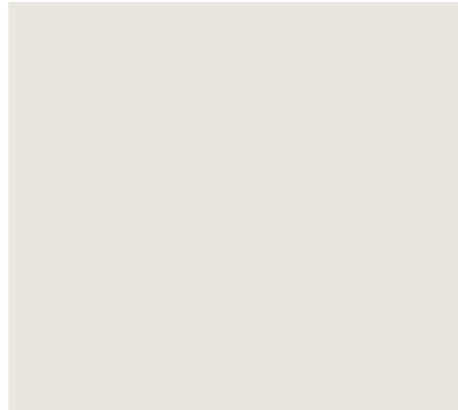

SERIE: STRIP

## ACABADO MELAMINA

### Blanco mate

Matte white / Bianco opaco / Branco mate / Blanc mate / Zuri matea / Branco mate



SERIES: LANDES / LIP / WOOD

### Pino lavado

Washed pine / Pinho lavado / Pi blanc / Pinu garbitua / Piñeiro lavado /



SERIE: módulos STRIP

# ACABADOS

## TRENT acabados lacados

### Blanco mate

Matte white / Bianco opaco / Branco mate / Blanc mate / Zuri matea / Branco mate

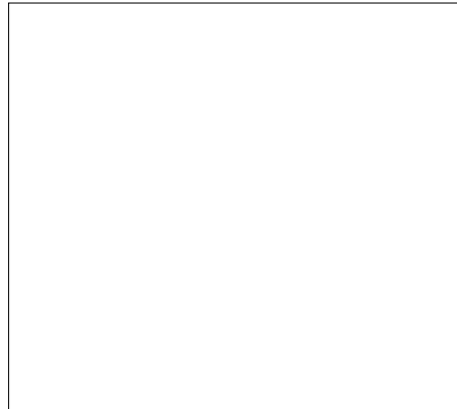

### Gris mate

Matte grey / Cinzento mate / Gris mat / Gris matea / Gris mate



- Los colores reproducidos son aproximados y pueden variar de los originales

## ACABADO MELAMINA CON TEXTURA

### Roble medio

Medium oak / Carvalho médio / Roure mitjà / Haritz ertainekoa / Carballo medio



SERIE: DÚO / TAURO / ARIES / GALSACKY / MOON

### Roble natural

Natural oak / Carvalho natural / Roure natural / Haritz naturala / Carballo natural



SERIES: SIGMA / LANDES / CAIRO / LIP / ESCORPIO / TAURO / WOOD / MAR / HOLE / ARIES / GALSACKY / SMALL / HOMY / COMET / TÍVOLI

### Vintage



SERIE: DENIM / WOOD

### Pino gris

Grey pine / Pinho cinzento / Pi gris / Pinu grisa / Piñeiro gris



SERIE: CAIRO / ESCORPIO / TAURO / WOOD / HOLE

### Nogal oscuro

Dark walnut / Nogueira escuro / Nogueira fosc / Intxaurrondo iluna / Nogueira escura



SERIE: CAIRO / ESCORPIO / MAR / GALSACKY

### Wengué

Wenge / Wenge / Wengué / Wenge / Wengué



SERIE: TAURO / ARIES

## ACABADO BRILLO

### Blanco

White / Branco / Blanc / Zuria / Branco



SERIES: OMEGA / CAIRO / DÚO / IKARO / WAVE / SKY / ESCORPIO / TAURO / MAR / ARIES / GALSACKY / SMALL / HOMY / COMET / TÍVOLI / DOMINÓ

### Moka

Mink



SERIES: OMEGA / LANDES

### Gris

Grey / Cinzento / Gris / Grisa / Gris



SERIES: OMEGA / LANDES / DÚO / IKARO / ESCORPIO / TAURO / GALSACKY / DOMINÓ

### Negro

Black / Petro / Negre / Zuri-beltzean / Negro



SERIES: DÚO / DOMINÓ

# CONDICIONES GENERALES DE VENTA Y SERVICIOS

ARTÍCULO 1 - ADHESIÓN A LAS CONDICIONES GENERALES DE VENTA Y SERVICIOS:

Un pedido se considerará válido sólo después de la aceptación por parte de COYCAMA. Cualquier modificación del pedido deberá ser obligatoria por escrito.

Cualquier pedido en firme y aceptado por COYCAMA implica la aceptación por parte del comprador de las presentes Condiciones Generales de Venta, sean cuales sean los términos que puedan aparecer en los documentos del comprador.

Las condiciones particulares que pueden eventualmente derogar las presentes Condiciones Generales de Venta y Servicios son vinculantes para COYCAMA si han sido expresamente aceptados por escrito por el mismo. Para los nuevos clientes será necesario aportar un número de cuenta bancaria y un formulario de apertura de cuenta debidamente cumplimentados, firmados y remitidos a COYCAMA. No será considerado ningún pedido sin la obtención de dichos documentos.

ARTÍCULO 2 - :

Los productos se facturarán con los s vigentes en las tarifas establecidas por COYCAMA que está disponible en los documentos comerciales.

Los s se indican en Euros y no incluyen impuestos. Toda la información incluida en este catálogo así como listas de s, son sólo indicativos y pueden cambiar en cualquier momento sin previo aviso.

ARTÍCULO 3 - ENVÍO

Portes pagados para pedidos con un importe de 100€ netos o superior, impuestos no incluidos. Para pedidos de menor importe se facturarán 10€ en concepto de transporte.

ARTÍCULO 4 - ENTREGA, RECEPCIÓN, RETRASOS Y DEVOLUCIONES:

4.1 - Los artículos vendidos serán devueltos a las instalaciones de COYCAMA por cuenta y riesgo del comprador, incluidos gastos de envío.

4-2 - Le corresponde al comprador comprobar los envíos a su llegada y de asegurarse de que las mercancías han sido entregadas dentro de lo normal y en buenas condiciones.

4.4 - En caso de daño o pérdida incumbe al comprador el hacer todas las gestiones. Se deberán mostrar los resguardos de entrega (carta de porte CMR, carta de embarque o carta de porte por aire ...) entregados a la recepción de la mercancía y refrendados por el transportista o su representante. En caso contrario el comprador no tendrá derecho a reclamación alguna.

**En cualquier caso, toda reclamación para ser admitida deberá ser remitida por correo electrónico a [ventas@coycama.com](mailto:ventas@coycama.com) detallando la causa y adjuntando una fotografía de la incidencia dentro de las 24 horas siguientes a la recepción de la mercancía.**

La existencia de reclamaciones no suspende el plazo de pago.

No habrá sanción económica debido a la falta o retrasos en la entrega por COYCAMA en ausencia de consentimiento previo por escrito. No se podrá devolver la mercancía sin el consentimiento previo expreso y por escrito de COYCAMA, que se obtiene, en particular, por fax o por correo electrónico.

Los gastos de devolución solamente correrán a cargo de COYCAMA en caso de defecto evidente reconocido por COYCAMA o su representante. Sólo el transportista seleccionado por COYCAMA debe realizar la devolución de los productos en cuestión.

4.3 - Los plazos de entrega son sólo para fines informativos, estos dependen en particular de la disponibilidad de los transportistas y el orden de llegada de los pedidos.

Un retraso en la entrega no puede comprometer la responsabilidad de COYCAMA o ser excusa para el retraso de pago u obtención de sanciones por daños y perjuicios.

ARTÍCULO 5 - RESPONSABILIDAD:

5-1 - Fuerza mayor:

COYCAMA no es responsable por incumplimiento de sus obligaciones en virtud de tales retrasos o imposibilidades para entregar cuando se debe a causas de Fuerza Mayor. Expresamente se considerará Fuerza Mayor, con excepción de los seleccionados por los tribunales españoles, retrasos o interrupciones en el transporte por cualquier motivo, falta de disponibilidad o

la escasez de material, en liquidación obligatoria de uno de sus proveedores o subcontratistas, el bloqueo o interrupción de los medios de comunicación, las telecomunicaciones y postal, incendio, inundación, huelga o parcial, herramientas de accidente, los nuevos requisitos normativos o las costumbres.

5.2 - Responsabilidad de los productos relacionados:

COYCAMA garantiza todos sus productos durante dos años por defectos de fabricación. La garantía está limitada a la reposición de la parte defectuosa o la idad del producto según se acuerde con el departamento comercial. COYCAMA en ningún caso asumirá costes de instalación o cualquier otro coste que se pudiera relacionar a la compra del producto.

COYCAMA no se hace responsable del producto en caso de incumplimiento de las condiciones de almacenamiento y/o uso del producto definido por la normativa aplicable así como las recomendaciones de COYCAMA.

En general, si el defecto es el resultado de un hecho imputable al comprador, sus empleados, agentes, contratistas o subcontratistas, COYCAMA no será considerada responsable.

5.3 - Recomendaciones para el uso y mantenimiento:

No almacene ni exponga el mueble directamente al sol. No almacenar o exponer los muebles en contacto directo con líquidos de forma prolongada ni abundante. Limpiar los muebles con un paño o una esponja húmeda. No utilice productos abrasivos. No use detergentes.

ARTICULO 6 - CONDICIONES DE PAGO:

6.1-El pago de las facturas será de un máximo de 60 días a convenir con el departamento comercial .

6.2-No obstante en el contexto de la gestión del riesgo Algicocina se reserva el derecho a exigir pago anticipado o incluso a suspender el servicio si se diera algún retraso en el pago de facturas.

6.3-Todo importe no pagado en la fecha del vencimiento generará a partir del día siguiente del impago un interés de demora a un tipo igual al aplicado por el Banco Central Europeo más 10 puntos porcentuales.

6.4-Todos los gastos en los que incurra Algicocina derivados de la gestión de cobro de la factura retrasada correrán a cuenta del comprador. Los intereses de demora correspondientes a una factura no serán inferiores a 150€.

6.5- En caso de falta de pago a su vencimiento Algicocina se reserva el derecho a reclamar los bienes que no han sido pagados conforme aparece en el apartado 7 reserva de propiedad.

ARTICULO 7 - RESERVA DE PROPIEDAD:

7.1-La transferencia de propiedad de bienes está sujeta al pago completo del por parte del comprador.

7.2- A la entrega de mercancía el comprador se convertirá en guardián y debe responder de los daños o desaparición de los bienes entregados por Algicocina hasta el completo pago de las facturas correspondientes.

ARTICULO 8 - JURISPRUDENCIA:

8.1-Cualquier disputa se resolverá conforme a la legislación Española en los tribunales de Castellón.

COYCAMA se reserva el derecho de modificar sin previo aviso la forma y el acabado de los productos por razones técnicas, comerciales o estéticas. Los medios utilizados para la reproducción de este catálogo no garantizan una fiel representación de los acabados y formas de los productos originales. Por lo que no se aceptarán reclamaciones referentes a las tonalidades y apariencia del producto.

Queda prohibida la reproducción o parcial del presente catálogo.

Imágenes protegidas.

Diseño de producto: Equipo Coycama. Todos los derechos reservados.

coycama





#### **COYCAMA**

##### **Fábrica y pedidos**

Tel. +34 977 72 01 19

Fax. +34 977 72 02 77

ventas@coycama.com

##### **Razón social**

Carreres les Forques

12200 Onda (Castellón) SPAIN

coycama@coycama.com

**[www.coycama.com](http://www.coycama.com)**