

**ARTELINEA**

FIRENZE 1962

**L'arte è ricerca continua, assimilazione delle esperienze passate, aggiunta di esperienze nuove, nella forma, nel contenuto, nella materia, nella tecnica, nei mezzi.**

**Art means continuous research, assimilation of the past experiences, addition of new experiences in form, contents, materials, technique, and means.**

**L'art est une recherche perpétuelle, l'assimilation des expériences passées, l'ajout de nouvelles expériences, dans la forme, le contenu, la matière, la technique, les moyens.**

**Kunst ist kontinuierliche Forschung, Assimilation von früheren Erfahrungen, das Hinzufügen neuer Erfahrungen im Bezug auf Form, Inhalt, Materie, Technik, Medien.**

**Bruno Munari**

Bisogna tornare con la mente alla Firenze degli irripetibili anni '60 per immaginare Marcello Gobbi, non ancora maggiorenne – allora lo si diventava a 21 anni –, avviare con grinta e determinazione l'attività di argentatura degli specchi e produzione di accessori in vetro.

Erano gli anni del boom: l'economia cresceva a ritmi vertiginosi e l'Italia metteva a frutto le innate abilità artigianali dei suoi giovani, – creativi, versatili e capaci di quell'elasticità e di quel dinamismo necessari a fronteggiare la domanda di beni per la casa e la persona.

Era il 1962 e Marcello, tuttora entusiasta depositario della memoria di tale fermento, stava ponendo le basi dell'industria vetraria che è divenuta leader nell'arredo bagno di design con il nome di Artelinea.

We should go back to the unique '60s in Florence for imagining Marcello Gobbi, not yet come of age – at that time people came of age at 21 –, who started his business of mirror plating and started creating glass accessories with true grit and determination. These were the years of the economic boom: the world economy was soaring and Italy was exploiting the natural handcrafted skills of its young people, – imaginative, versatile, dynamic and ready to deal with the demand for home and individual goods. It was the 1962 and Marcello, enthusiastic custodian of the memory of that sweeping change, was laying the foundations of the glass factory that would have later become a leader in bathroom furnishing, known as Artelinea.

Nous devons nous replacer dans l'état d'esprit des incomparables années 1960 à Florence pour imaginer Marcello Gobbi, alors mineur (la majorité était alors à 21 ans) commencer avec courage et détermination son activité d'argenture des miroirs et la fabrication d'accessoires en verre. L'époque était prospère : l'économie progressait à un rythme vertigineux, et l'Italie commençait à exploiter les aptitudes innées pour l'artisanat de ses jeunes, – créatifs, polyvalents et capables de cette élasticité et de ce dynamisme nécessaires pour satisfaire la demande en biens pour la maison et la personne. C'était en 1962, et Marcello, encore dépositaire enthousiaste de la mémoire de cette effervescence, jetait les bases de l'industrie du verre qui est devenue un leader dans le mobilier de salle de bains design sous le nom d'Artelinea.

Wir müssen in Gedanken in das Florenz der unnachahmbaren 60er Jahre zurückgehen, um uns Marcello Gobbi vorzustellen. Noch nicht volljährig – damals wurde man dies erst mit 21 Jahren – begann er mit viel Ehrgeiz und Entschiedenheit mit dem Versilbern von Spiegeln und der Herstellung von Glaszubehör. Es waren die Jahre des Booms: Die Wirtschaft wuchs in schwindelerregendem Tempo und Italien begann, das angeborene handwerkliche Geschick seiner jungen kreativen und vielseitigen Menschen zu nutzen, die in der Lage waren, mit ihrer Flexibilität und ihrer Dynamik die Nachfrage nach Konsumgütern für Haus und Menschen zu decken. Man schrieb das Jahr 1962 und Marcello, der bis heute diese Kreativität aufrechterhält, legte den Grundstein für die Glasindustrie, die mit dem Namen Artelinea Marktführer für Einrichtungen von Design-Bädern wurde.



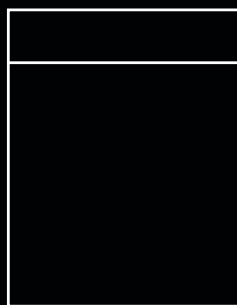
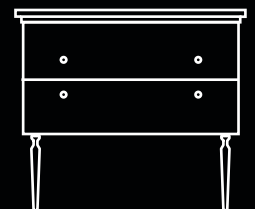
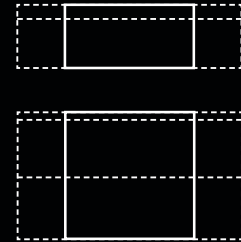
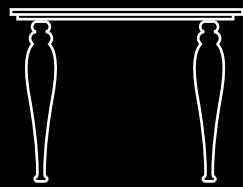
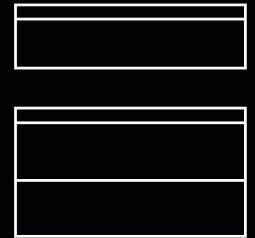
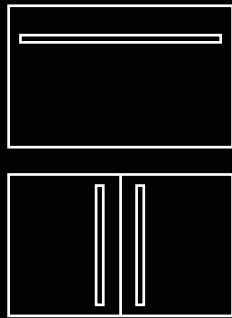
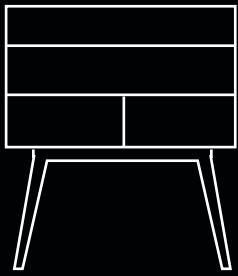

15	<b>Dama</b>
61	<b>Riga</b>
79	<b>Monolite2.0</b>
	<b>Monolitepiù</b>
101	<b>Domino</b>
113	<b>Domino44</b>
127	<b>DominoLegno</b>
135	<b>Regolo</b>
147	<b>Incanto</b>
161	<b>Kimono</b>
171	<b>Decor</b>
181	<b>I Borgia</b>
191	<b>Metafora</b>
201	<b>Atollo</b>
209	<b>Frame</b>
219	<b>Bolla</b>
231	<b>Zen</b>
239	<b>Accessori e Illuminazione</b> Accessories and lighting Accessoires et éclairage Zubehör und Beleuchtung
255	<b>Materiali e tecnologie</b> Materials and technologies Matériaux et technologies Materialien und Technologien

Il capitale umano, il senso di appartenenza, il coraggio imprenditoriale da sempre contraddistinguono la crescita dell'azienda, che – dai luoghi considerati cuore del Rinascimento e universalmente riconosciuti culla dell'arte, dell'architettura, della moda e della bellezza –, può vantare oggi una dimensione internazionale. Grazie al contributo dei figli Massimo e Marco, e a collaborazioni con designer e università, Artelinea offre prodotti di altissima qualità e in gran parte realizzati su misura, distribuiti attraverso punti vendita e showroom in tutta l'Europa occidentale e negli Stati Uniti.



The human capital, the feeling of belonging, the business courage have ever marked the factory growth. The factory, funded in that place that is considered to be the very heart of the Renaissance and of the art, architecture, fashion and beauty can now boast a worldwide character. Thanks to the contribution of Marcello's sons, Massimo and Marco, and to the cooperation with several designers and universities, Artelinea offers high quality and customized products, supplied through the best showrooms and retailers in the Western Europe and the USA.

Le capital humain, le sentiment d'appartenance, le courage entrepreneurial ont toujours distingué la croissance de l'entreprise, qui - à partir des lieux considérés comme le cœur de la Renaissance et universellement reconnus comme le berceau de l'art, de l'architecture, de la mode et de la beauté - peut se vanter aujourd'hui d'avoir une stature internationale. Grâce à la contribution de ses fils Massimo et Marco, et aux collaborations avec des designers et des universitaires, Artelinea offre des produits de haute qualité et la plupart du temps sur mesure, distribués dans des magasins et des showrooms dans toute l'Europe occidentale et aux États-Unis.

Ein hoher Qualitätsstandard bedeutet alles für uns, genauso wie die tief verwurzelte Exklusivität bei der Herstellung von maßgefertigten Spiegeln, Waschbecken, Tops, Möbeln und Accessoires. Jede Stufe der Produktion erfolgt innerhalb des Unternehmens unter unserer strengen Kontrolle: Schneiden, Biegen, Schleifen, Formen, Farbgebung und Laserbearbeitung auf einem Schneidetisch der neuesten Generation. Auch die Möbel werden von erfahrenen Kunsthandwerkern in unserer Tischlerei hergestellt, die sich neben der Beleuchtungsabteilung befindet, wo Spiegel und die entsprechende Verkabelung eingebaut werden.



Il fondatore e Presidente Marcello Gobbini tra i figli Marco (a sinistra), responsabile vendite e Massimo (a destra), responsabile della produzione

The founder and President, Marcello Gobbini, between his sons, Marco (on the left side) the sales manager and Massimo (on the right side) the production manager.

Le fondateur et président Marcello Gobbini entre ses enfants: Marco (à gauche), directeur commercial, et Massimo (à droite), directeur de production.

Der Firmengründer und Präsident Marcello Gobbini inmitten seiner Söhne Marco (links), Verkaufsleiter, und Massimo (rechts) Produktionsleiter.



Lo show-room rappresenta per acquirenti, progettisti e rivenditori un punto di riferimento. Qui i prodotti acquisiscono una piena leggibilità: possono essere osservati, toccati, apprezzati. L'ufficio commerciale che segue il mercato estero è in grado di relazionarsi in lingua inglese, tedesco, francese, e spagnolo.

Our show-room represents a reference point for buyers, designers and retailers. Products become real there: they can be observed, touched, and admired. The sales department follows all our major markets, speaking Italian, English, German, French and Spanish.

Notre showroom représente un point de référence pour les particuliers, les designers et les revendeurs. Ici les projets se transforment en réalité et nos collections peuvent être observées, touchées et appréciées. Notre équipe du service commercial export parle couramment italien, anglais, allemand, français et espagnol pour s'occuper facilement de toutes les exigences de nos clients.

Unsere Ausstellung ist eine wichtige Referenz für Architekten, Wiederverkäufer und Endkunden. Hier können alle unsere Produkte besichtigt und angegriffen werden. Unser Verkaufsbüro beantwortet gerne alle Kundenanfragen, sowohl in englischer, deutscher, französischer als auch in spanischer Sprache.





## Ricerca, design e produzione

Prima ancora di progettare un prodotto, ci concentriamo sullo studio dei materiali: questa è la chiave di lettura delle collaborazioni con il Dipartimento di Chimica dell'Università di Firenze, con la Scuola del Vetro di Murano, Venezia, e con numerosi ricercatori, oltre che dei nostri continui investimenti in tecnologia. Non ci fermiamo nemmeno davanti a macchinari e forni che non consentono le lavorazioni a cui abbiamo pensato: con caparbietà e grazie a intuizioni e all'esperienza, li modifichiamo o li adattiamo per ottenere bagni e lavandini sempre spettacolari.

### Research, design and production

Before designing a product we focus on the study of its materials: this is the interpretation key of our cooperation with the Department of Chemistry of the University of Florence, with the "Scuola del Vetro" in Murano, Venice, and with several researchers in addition to our ongoing investments in technology. We do not give up even when faced with equipment and ovens which do not allow us to work the way we had thought: we modify them with stubbornness, thanks to our experience and our intuitions so that we can obtain extraordinary bathroom furnishing and basins.

### Recherche, design et production

Avant même la conception d'un produit, nous nous concentrons sur l'étude des matériaux : telle est la clé de lecture des collaborations avec le Département de Chimie, de l'Université de Florence, avec l'École du Verre de Murano, Venise, et avec de nombreux chercheurs, ainsi que de nos investissements continus dans la technologie. Nous ne renonçons jamais, pas même face à des machines et à des fours qui ne permettent pas toujours de réaliser les transformations du verre que nous avons imaginées et étudiées: avec détermination et grâce à des idées et à l'expérience, nous les modifions ou les adaptons pour obtenir des vasques toujours plus spectaculaires.

### Forschung, Entwicklung und Herstellung

Noch bevor wir ein Produkt entwerfen, konzentrieren wir uns auf die Untersuchung der Materialien: Dies ist die Grundlage für eine Zusammenarbeit mit der Fakultät Chemie der Universität von Florenz, der Schule für Glasarbeit in Murano, Venedig, und mit zahlreichen Forschern. Zudem investieren wir kontinuierlich in die Technologie. Wir lassen uns nicht von Maschinen oder Öfen einschränken, die eine von uns erdachte Verarbeitung nicht erlauben: Mit Entschlossenheit und Dank Intuition und Erfahrung verändern wir sie oder passen sie entsprechend an, um unsere einzigartigen Bäder oder Waschbecken produzieren zu können.



## Artelinea Company Profile

L'elevato standard qualitativo, per noi, è tutto, così come l'esclusività insita nella realizzazione su misura di specchi, lavabi, top, mobili e accessori. Ogni fase della lavorazione avviene all'interno dell'azienda, sotto il nostro stretto controllo: taglio, piegatura, molatura, fusione, verniciatura, lavorazione laser su tavolo da taglio di ultima generazione. Anche i mobili sono interamente prodotti dagli esperti artigiani della nostra falegnameria, direttamente collegata al reparto d'illuminotecnica in cui si montano gli specchi e si effettua il cablaggio.

For us, high quality standards along with exclusivity in manufacturing, customized mirrors, basins, tops, vanity units and accessories are essential. Each step in the production process takes place in our factory so that we can closely monitor it: from the cut to bending, grinding, fusion, painting, and, finally, to the laser works on a special table of the latest generation. Even the vanity units are totally manufactured from the skilled artisans of our woodworking department, directly linked with our illuminating engineering department where mirrors are assembled and wiring made.

Pour Artelinea, les standards qualitatifs élevés sont essentiels, tout comme l'exclusivité inhérente à la réalisation sur mesure de miroirs, de vasques, de plateaux, de meubles et d'accessoires. Chaque étape de la production a lieu au sein de la société, sous notre contrôle strict : la coupe, le pliage, le meulage, le moulage, l'émaillage, le traitement au laser sur la table de coupe de dernière génération. Le mobilier également est entièrement produit par les artisans experts de notre menuiserie qui est directement reliée aux ateliers d'assemblage et de câblage des miroirs.

Ein hoher Qualitätsstandard bedeutet alles für uns, genauso wie die tief verwurzelte Exklusivität bei der Herstellung von maßgefertigten Spiegeln, Waschbecken, Tops, Möbeln und Accessoires. Jede Stufe der Produktion erfolgt innerhalb des Unternehmens unter unserer strengen Kontrolle: Schneiden, Biegen, Schleifen, Formen, Farbgebung, Laserbearbeitung auf einem Schneidetisch der neuesten Generation. Auch die Möbel werden von erfahrenen Kunsthandwerkern in unserer Tischlerei hergestellt, die sich neben der Beleuchtungsabteilung befindet, wo Spiegel und die entsprechende Verkabelung eingebaut werden.

**12.500 mq di produzione**  
**Tecnologie innovative**  
**Lavorazione interna**

**12.500 m<sup>2</sup> of production department**  
**Innovative technologies**  
**Internal production**

**12 500 m<sup>2</sup> de production**  
**Technologies innovantes**  
**Usinage en interne**

**12.500 Quadratmeter Produktion**  
**Innovative Technologien**  
**Interne Produktion und Verarbeitung**





## Innovazione e pensiero green

Il vetro è per definizione riciclabile ed ecocompatibile. Perché la sua lavorazione lo sia altrettanto, abbiamo abbracciato appieno il modello di economia produttiva a impatto zero. I nostri impianti prevedono, infatti, un ricircolo totale delle acque di lavorazione e l'utilizzo delle acque raccolte in vasche pluviali.

### Innovation and ecology

The glass is a recyclable and eco-friendly material, so is our glass processing industry: in fact, we have totally encompassed the model of productive economy with zero environmental impact. Our plant has been created to have a total reuse of the used waters and rainwater.

### Innovation et pensée verte

Le verre est par définition recyclable et respectueux de l'environnement. Pour que sa transformation le soit également, nous avons pleinement adopté le modèle d'économie productive à impact zéro. Nos systèmes prévoient, en effet, une recirculation totale des eaux utilisées et l'utilisation de l'eau collectée dans les réservoirs d'eau de pluie.

### Innovation und grünes Denken

Glas ist per Definition recycelbar und umweltfreundlich. Damit dies auch für seine Verarbeitung gilt, haben wir uns voll und ganz einem ökologisch nachhaltigen Herstellungsmodell verschrieben. Unsere Systeme sehen die Rückführung des gesamten zur Produktion verwendeten Wassers vor, das in Regentanks gesammelt wird.



## Green company

Sul nostro stabilimento di oltre dodicimila mq abbiamo installato un impianto di pannelli fotovoltaici in grado di produrre l'80% del fabbisogno energetico e di abbattere l'impatto che le lavorazioni hanno sull'ambiente, secondo una precisa volontà ecologica. Risponde al medesimo spirito, la nostra politica degli imballaggi: nello scatolificio interno all'azienda, confezioniamo su misura e con cartone 100% riciclato, l'imballo di ogni singolo prodotto pronto per la consegna.

### Green company

In our plant of more than 12,000 m<sup>2</sup> we have installed photovoltaic panels which can produce 80% of our company's energy needs and can eliminate the environmental impact of our production, according to a precise green strategy. Our packaging aims at the same goal: in our internal box factory we produce made to measure packaging using 100% recycled cardboard for each product that is then ready to be shipped

### Société green

Sur nos locaux de plus de douze mille mètres carrés, nous avons installé un système de panneaux photovoltaïques en mesure de couvrir 80 % de nos besoins énergétiques et de réduire l'impact de nos activités sur l'environnement, selon une volonté écologique précise. Dans ce même esprit, notre politique des emballages : nous confectionnons, dans nos ateliers, un emballage réalisé sur mesure pour chaque produit et avec du carton 100% recyclé.

### Ein grünes Unternehmen

Als umweltbewusstes Unternehmen aus Überzeugung, haben wir auf dem Gelände von über zwölftausend Quadratmetern eine Fotovoltaik-Anlage installiert, die 80 % unseres Energiebedarfs erzeugt und somit der Arbeitsprozess keine Auswirkungen auf die Umwelt hat. Mit dem gleichen Geist gehen wir bei unserer Verpackungspolitik vor: In der Verpackungsabteilung innerhalb unseres Unternehmens wird jedes einzelne Produkt nach Maß in 100 % recycelten Kartons versandfertig verpackt









Dama racconta la capacità di usare il cristallo come elemento fondante del prodotto e non come mero ornamento.  
Con **dualite**<sup>®</sup> il vetro diventa vera struttura e si amplificano le sue capacità espressive

Dama represents the glass used as the essential element of the product, not as a simple decoration. With **dualite**<sup>®</sup> the glass becomes real structure and it amplifies its expressiveness.

Dama signifie savoir utiliser le verre comme matériau constitutif du produit et non seulement comme simple décoration. Avec **dualite**<sup>®</sup> le verre devient une véritable structure et multiplie son expressivité.

Dama erfindet das Glas neu, und zwar als essenzielles Element des Produktes, und nur nicht als einfaches Dekorelement. Mit **dualite**<sup>®</sup> erhält das Glas eine wirkliche Struktur und offenbart seine Ausdruckskraft.

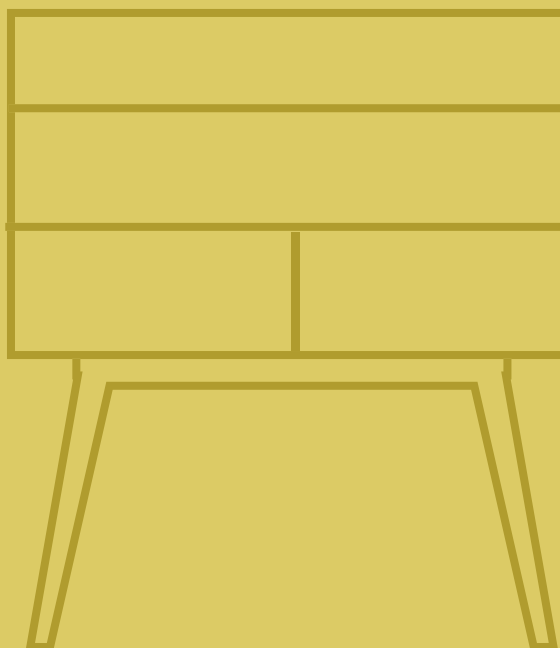



La collezione Dama ha superato i test e le prove effettuate dai laboratori Catas e risponde alle normative  
 EN 14749:2016  
 EN 16122:2012  
 EN 14072:2003  
 per quanto applicabili

The Dama collection has been tested in the CATAS laboratories and it has passed the tests according to the applicable law  
 EN 14749:2016  
 EN 16122:2012  
 EN 14072:2003

La collection Dama a été testée par les laboratoires CATAS et a passé avec succès les tests selon les normes  
 EN 14749:2016  
 EN 16122:2012  
 EN 14072:2003

Das Produkt wurde im Labor von CATAS getestet und hat die Tests  
 EN 14749:2016  
 EN 16122:2012  
 EN 14072:2003  
 bestanden.

## dama

La razionalità del disegno del monoblocco è sdrammatizzata sia dalla componibilità interna data dai cassetti e dai vani a giorno, posizionabili liberamente all'interno dello spazio, sia dalla possibilità di abbinare colori diversi, grazie a **dualite®**.

The rationality used for drawing basin units is minimized by the internal composition of drawers and open compartments – which can be freely combined – and by the possibility to match different colours, thanks to **dualite®**.

La rationalité des lignes de la structure monobloc est dédramatisée par la modularité interne des éléments, par le positionnement libre de tiroirs, caissons et étagères et par la possibilité de combiner plusieurs couleurs et finitions grâce à **dualite®**.

Das schlichte, aber auch herausstechende Design des Monoblocks wird durch seine zahlreichen Kombinationsmöglichkeiten wie z.B. den internen Schubladen, das frei positionierbare Zubehör oder zahlreichen Farbkombinationen des **dualite®** vollendet.





Composition **AL568**

**Dama Collection**

Cabinet Covering

**Terra 16/Bianco silk 70 + China**

Column Covering

**Avana 45/Bianco Assoluto 30**

Mirror

**Luminee Collection**









Composition **AL569**

**Dama Collection**

Cabinet Covering

**Terra 16/Bianco silk 70 + China**

Benches covering

**Avana silk 05/Bianco Assoluto 30 + China**

Column covering

**Avana 45/Bianco Assoluto 30**

Mirror

**Luminee Collection**











Composition **AL564**

**Dama Collection**

Cabinet Covering

**Sardinia 26/Fumo 11 +  
Noce Canaletto**

Mirror

**Dama Collection**





Composition **AL563**

**Dama Collection**

Cabinet Covering

**Cipria 35/Terra silk 94 +**

**Noce Canaletto**

Mirror

**Dama Collection**





Composition **AL570**

**Dama Collection**

Top&Basintop

**Cipria 35**

Cabinet Covering

**Cipria 35/Noce silk 67 +**

**Noce Canaletto**

Mirror

**Argento Collection**











Composition **AL571**

**Dama Collection**

Cabinet Covering

**Avana 45/Avana silk 05/Rosso silk 92 +  
Cotone**

Bench Covering

**Avana silk 05/Bianco Assoluto 30 +  
Cotone**

Shelves Covering

**Avana 45/Rosso 22  
Rosso 22/ Avana 45**

Mirror

**Primus Collection**









Composition **AL572**

**Dama Collection**

Top&Basintop

**Opalite Bianco 20**

Cabinet Covering

**Bianco Assoluto 30/Sardinia 26**

Shelves covering

**Sardinia 26/Notte silk 99**

Floor standing Cabinet Covering

**Bianco Assoluto 30/Sardinia 26 +**

**Cotone**

Mirror

**Led Collection**

**Bianco Assoluto 30/Notte silk 99**





Composition **AL573A**

**Dama Collection**

Top&Basintop

**Opalite Bianco 20**

Cabinet Covering

**Bianco Assoluto 30/Notte 39**

Mirror

**Led Collection**

Composition **AL573B**

**Dama Collection**

Top&Basintop

**Opalite Bianco 20**

Cabinet Covering

**Bianco Assoluto 30/Rosso 22**

Mirror

**Led Collection**

Composition **AL573C**

**Dama Collection**

Top&Basintop

**Opalite Bianco 20**

Cabinet Covering

**Bianco Assoluto 30/Noce 41**

Mirror

**Led Collection**





Composition **AL573D**

**Dama Collection**

Top&Basintop

**Opalite Bianco 20**

Cabinet Covering

**Bianco Assoluto 30/Sabbia 49**

Mirror

**Led Collection**







Composition **AL574**

**Dama Collection**

Top&Basintop

**Opalite Bianco 20**

Cabinet Covering

**Tortora 33/Terra 16**

Shelves Covering

**Avana 45/Rosso 22**

**Rosso 22/ Avana 45**

Mirror

**Cubo Collection**









Composition **AL575**

**Dama + Regolo Collection**

Top&Basintop

**Opalite Bianco 20**

Cabinet Covering

**Fumo silk 47/Limone silk 66/**

**Bianco Assoluto 30**

Floor standing Cabinet Covering

**Bianco Assoluto 30 + Seppia 60**

Mirror

**Dama Box Collection**

**Limone silk 66/**

**Bianco Assoluto 30**









MAGGIO  
**29**  
LUNEDÌ



Dama

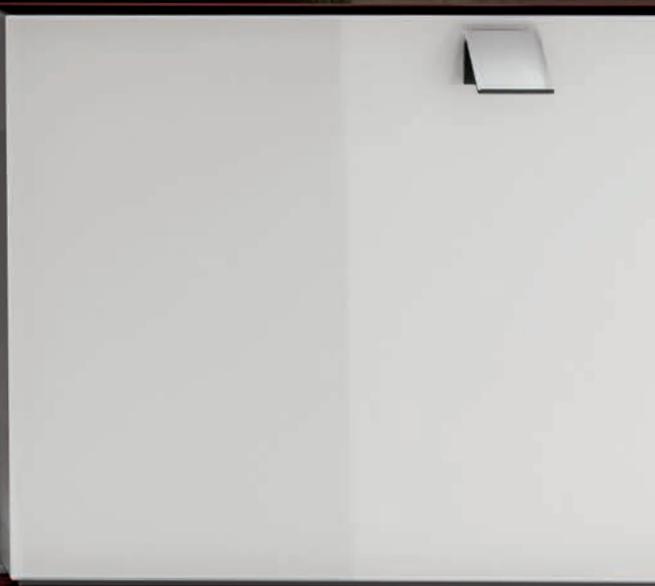
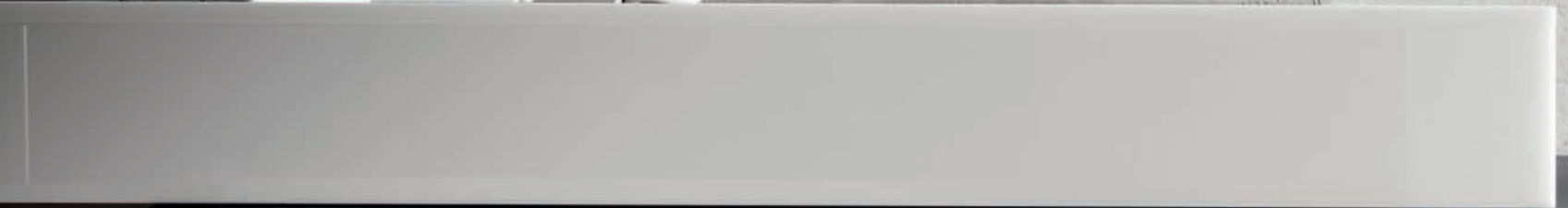

Composition **AL576**

**Dama + Regolo Collection**

Top&Basintop

**Opalite Bianco 20**

Cabinet Covering

**Seppia silk 93/Rosso 22/Bianco Assoluto 30**

Floor standing Column Covering

**Bianco Assoluto 30/ Bianco Assoluto 30 +  
Cotone**

Mirror

**Cubo Collection**









Composition **AL565**

**Dama + Regolo Collection**

Top&Basintop

**Opalite Bianco 20**

Cabinet covering

**Tortora silk 53/Notte 39 +**

**Noce Canaletto**

Mirror

**Laser Collection**







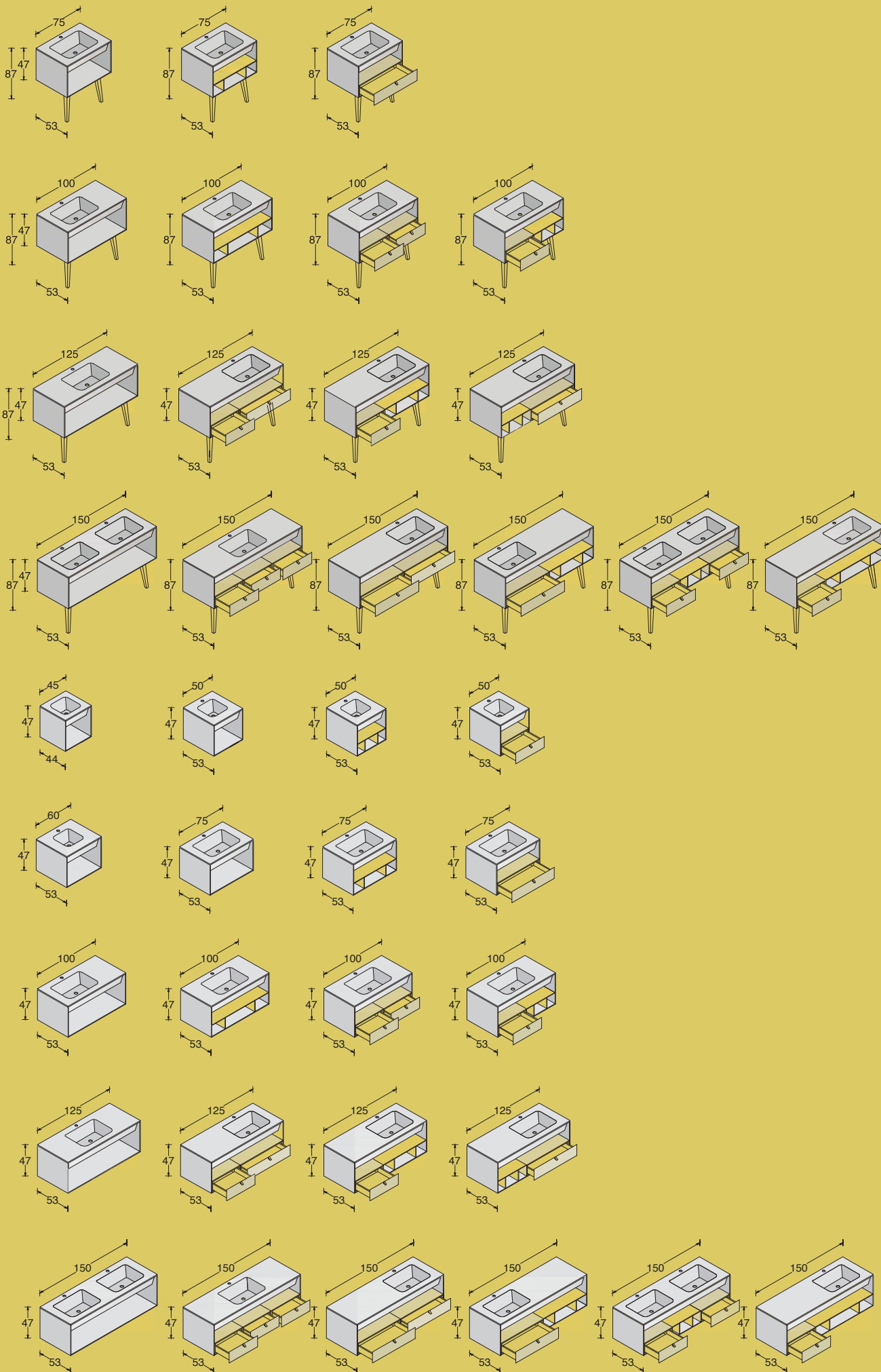

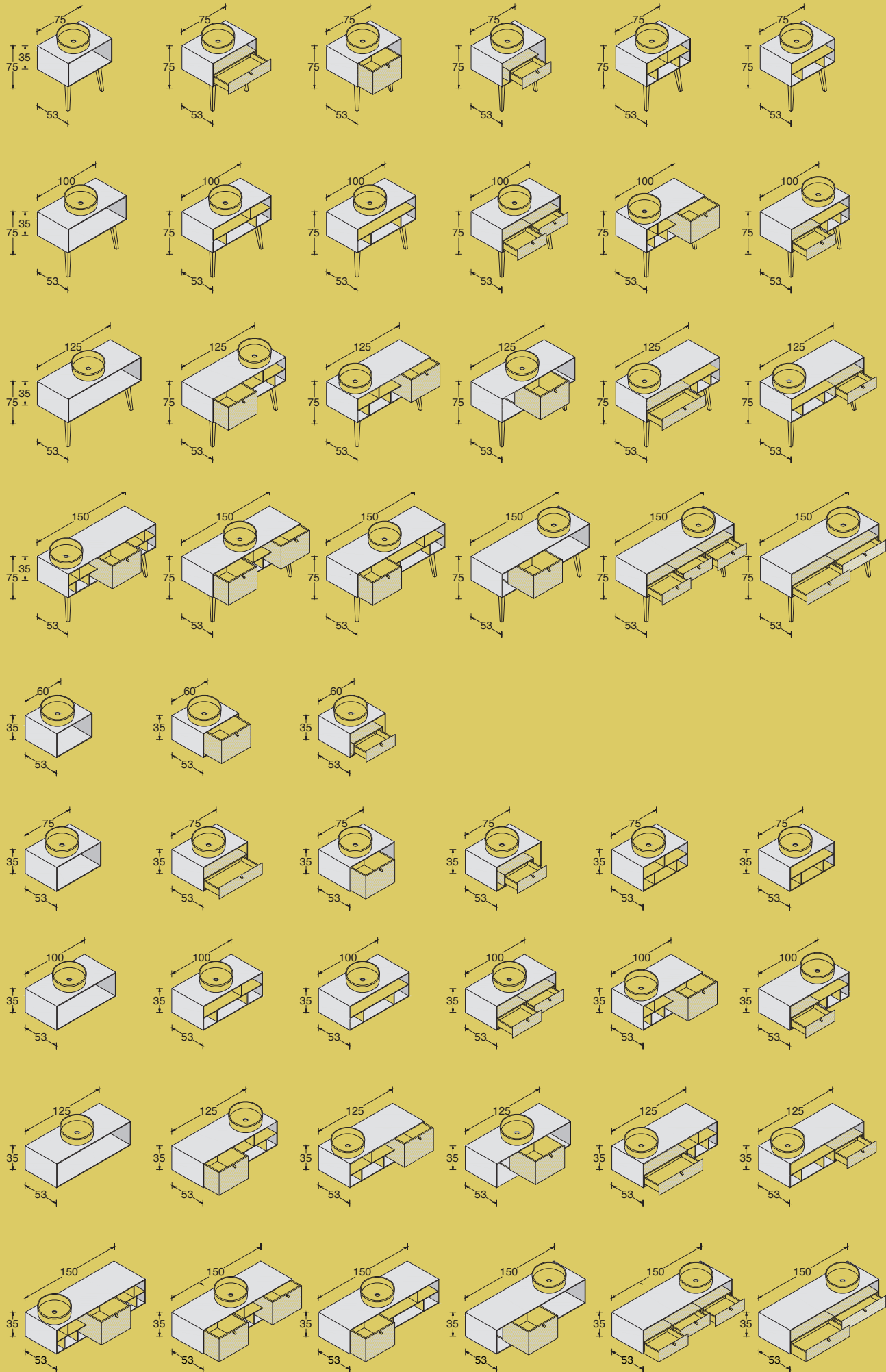



# Riga

Riga è il parallelepipedo rigoroso reso dinamico dalla maniglia. Verticale ed orizzontale, in vetro colorato o legno, la nuova maniglia è l'elemento distintivo di una collezione che resta fedele alla tradizione Artelinea nella ricerca di versatilità ed estrema componibilità.

Riga is a rigid parallelepiped that becomes dynamic thanks to its handle. Both vertical and horizontal, in colored glass or wood, the new handle is the key feature of this collection which is faithful to the Artelinea tradition in searching versatility and extreme combination.

Riga est le parallélépipède rigoureux dynamisé par sa poignée. Verticale ou horizontale, en verre coloré ou en bois, la nouvelle poignée est l'élément distinctif d'une collection qui reste fidèle à la tradition Artelinea dans sa recherche de versatilité et de modularité.

Riga ist sehr vielseitig in ihrer Anwendung, denn die Kollektion gibt es in vertikaler- oder horizontaler Ausführung sowie mit Holz- oder Glasapplikationen. Der neue Griff bietet nicht nur zahlreiche Kombinationsmöglichkeiten, sondern sticht auch besonders hervor, während das Möbel selbst dem traditionellen Stil von Artelinea treu bleibt.

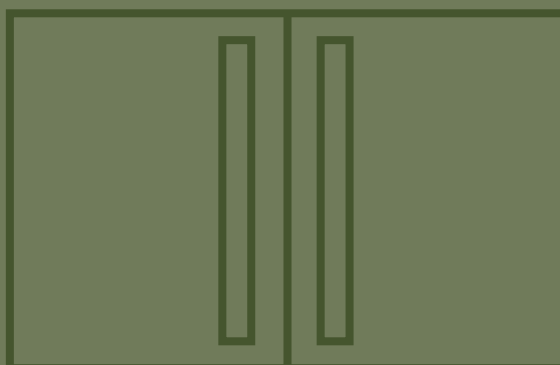
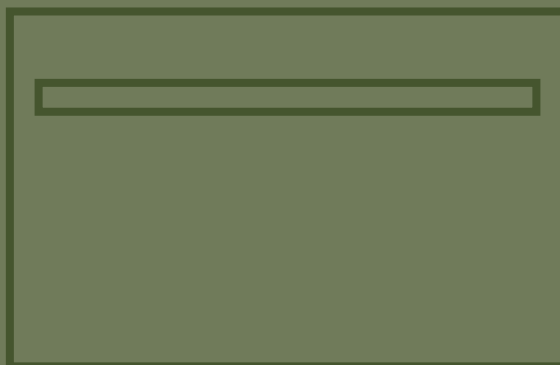



## **riga**

Riga racchiude un disegno razionale e rigoroso arricchito da innovazione e memoria.

Riga has a rational and precise line enriched by innovation and memory.

Riga renferme un dessin rationnel et rigoureux enrichi par l'innovation et la mémoire.

Das rationelle undschlichte Design von Riga verbindet gleichzeitig Innovation und Geschichte.



Composition **AL577**

**Riga Collection**

Top&Basintop

**Opalite Bianco 20**

Cabinet covering

**Avana silk 05**

Shelves Covering

**Avana 45/Erba 63**

Mirror

**Flash Collection**







Composition **AL578**

**Riga Collection**

Top&Basintop

**Tortora 33**

Cabinet covering

**Tortora silk 53/ Tortora 33**

Mirror

**Flash Collection**



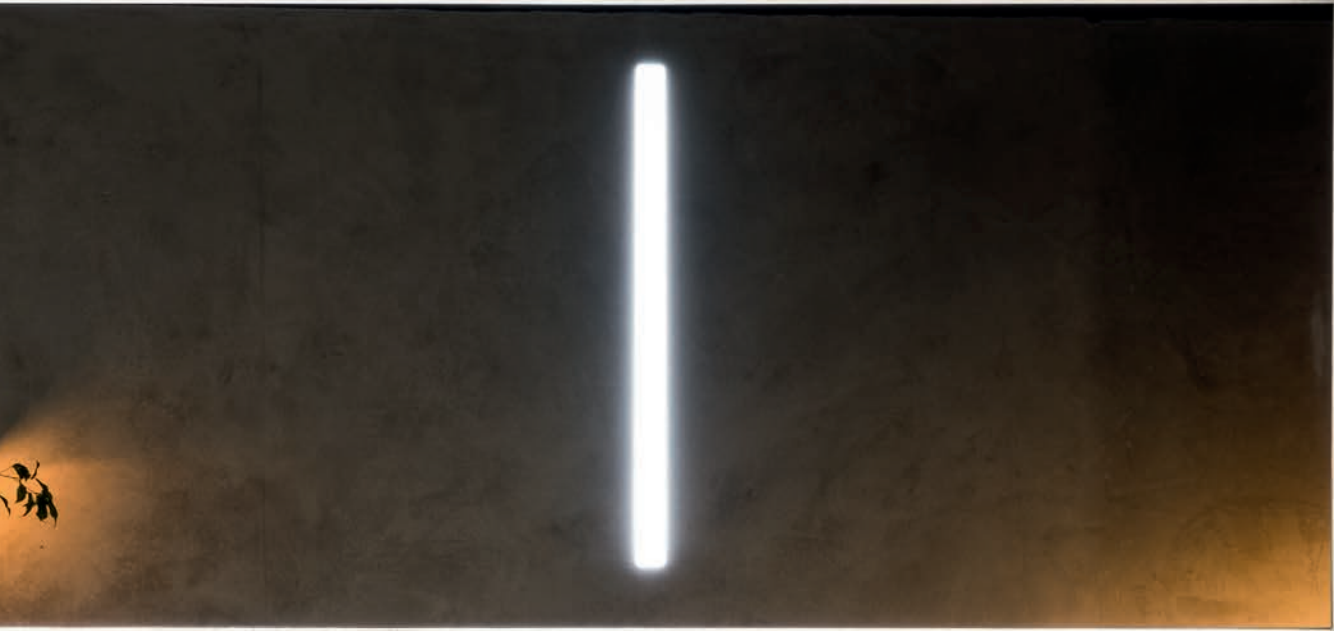



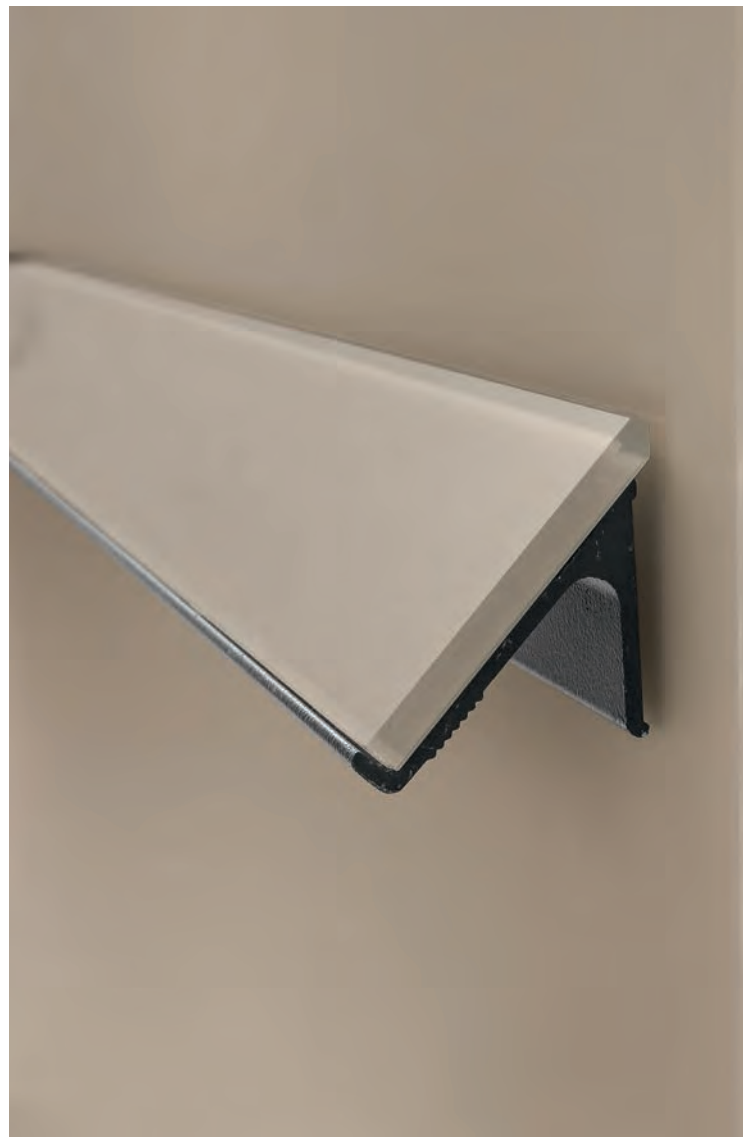

Composition **AL579**

**Riga Collection**

Top&Basintop

**Opalite Bianco 20**

Cabinet covering

**Bianco silk 70/ Avana 45**

Shelves covering

**Seppia silk 93/ Avana silk 05**

Mirror

**Dama Box + Led Collection**

**Bianco Assoluto 30/Avana 45**

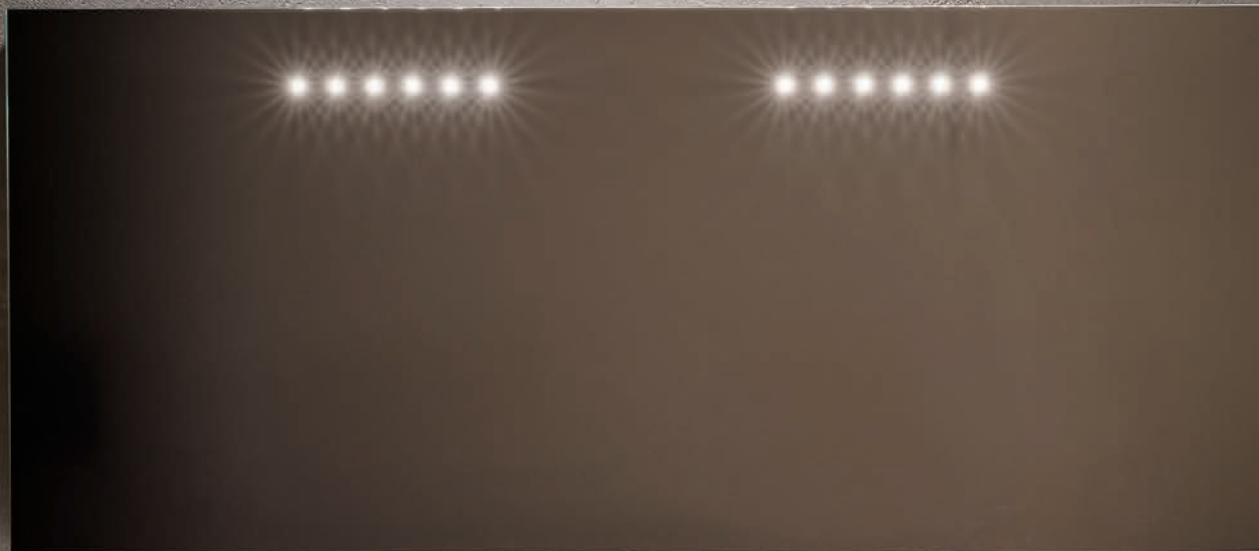



Composition **AL566**

**Riga Collection**

Top&Basintop

**Opalite Bianco 20**

Cabinet covering

**Avana silk 05**

Mirror

**Primus Collection**







Composition **AL567**

**Riga Collection**

Top&Basintop

**Opalite Bianco 20**

Cabinet covering

**Bianco silk 70/Noce Canaletto**

Shelves covering

**Avana silk 05/Rosso 22**

Mirror

**Cubo Collection**







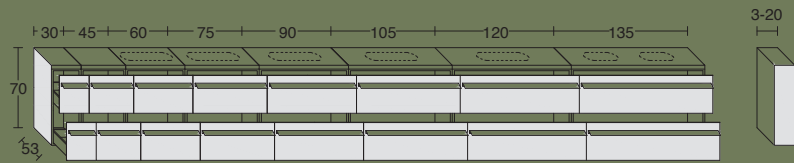
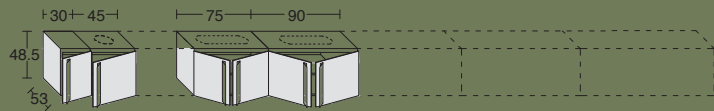
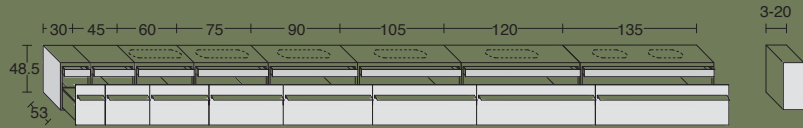
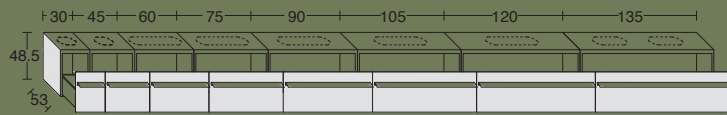
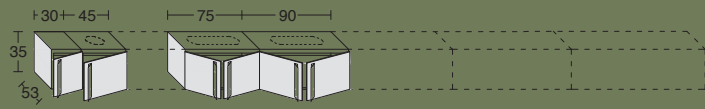
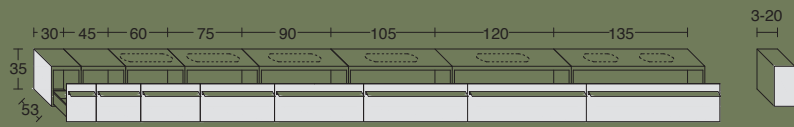



# Monolite

La collezione Monolite è nata per diventare paradigma del connubio tra tecnologia e poesia della materia, tra rigore delle forme e preziosità delle superfici e per essere il sinonimo del "tutto vetro" by Artelinea.

The Monolite collection was born from the paradigm of the marriage between technology, poetry of material, rigorous shapes and the splendour of surfaces, thus creating a synonym for "glass" by Artelinea.

La collection Monolite est le paradigme de l'union entre technologie et poésie de la matière, entre rigueur des formes et finesse des détails . Monolite, c'est le « Tutto Vetro » by Artelinea.

Die Kollektion MONOLITE verbindet die Technologie und die Poesie der Materie, die strikten Formen und die Kostbarkeit der Oberfläche. MONOLITE ist das Synonym von „Alles Glas!“.

## Monolite2.0 Monolitepiù

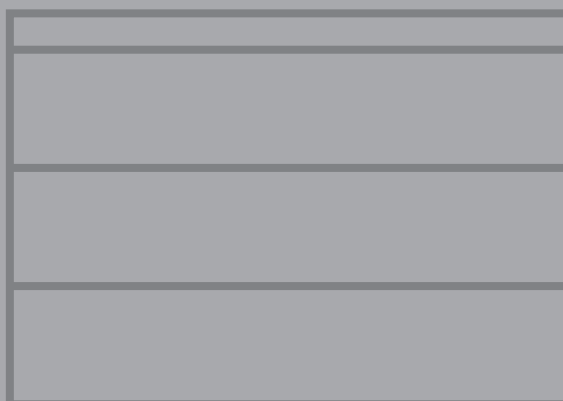
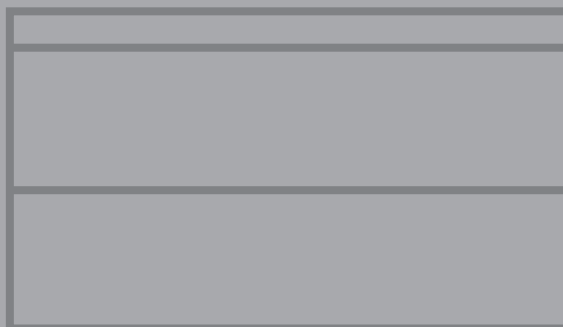
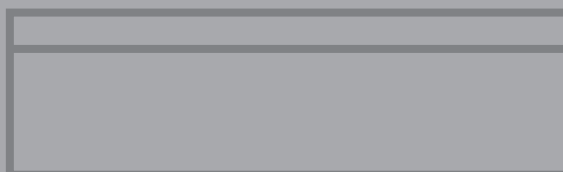



## Monolite

Oltre le mode per rispondere alla vocazione di misura ed eleganza classiche, Monolite diventa attuale nella versatilità delle composizioni e nella libertà progettuale. Sempre elegante e misurato Monolite si presta a diventare elemento della progettazione permettendo di utilizzare moduli diversi, adatti anche a situazioni spaziali restrittive.

Monolite is up-to-date in due to the combinable units and the customised elements available within the range. Always elegant and measured, Monolite lends itself to become an element of the overall bathroom design and due to the varying sizes available it is also suitable for small spaces.

Au-delà des modes, Monolite respecte sa vocation de sobriété et d'élégance classiques tout en exprimant sa fraîcheur à travers la modularité de ses compositions et sa liberté de conception. Avec élégance et mesure, Monolite devient un élément de design adaptable aux espaces les plus restreints.

Neue Abmessungen und ein angepasstes Design zeigen ein weiteres Mal die Vielfalt und Flexibilität dieser Kollektion auf. Monolite ist dank der vielseitigen Abmessungen und Kombinationsmöglichkeiten für unzählige Projekte geeignet und bietet sich daher auch sehr gut zum Einrichten von kleinen Flächen an.





Composition **AL351**

**Monolite Collection**

Top&Basintop

**Opalite Bianco 20**

Cabinet covering

**Bianco Assoluto 30**

Mirror

**Move Collection**





Composition **AL352**

**Monolite Collection**

Top&Basintop

**Opalite Bianco 20**

Cabinet covering

**Bianco Assoluto 30**

Mirror

**Flash Collection**





Composition **AL354**

**Monolite Collection**

Top&Basintop

**Opalite Bianco 20**

Cabinet covering

**Tortora Silk 53**

Mirror

**Luminee Collection**





Composition **AL356**

**Monolite Collection**

Top&Basintop

**Opalite Bianco 20**

Cabinet covering

**Kerlite Perle 78**

Mirror

**Move Collection**











Composition **AL509**

**Monolite Collection**

Top&Basintop

**Tortora 33**

Cabinet covering

**Tortora 33**

Mirror

**Flash Collection**





Composition **AL510**

**Monolite + Summa Collection**

Top&Basintop

**Opalite Bianco 20**

Cabinet covering

**Seppia 60**

Mirror

**Led Collection**









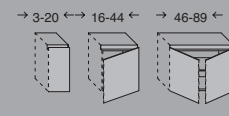
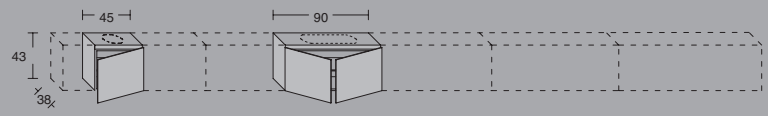
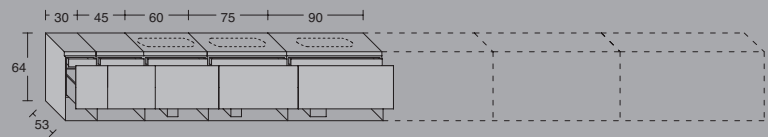
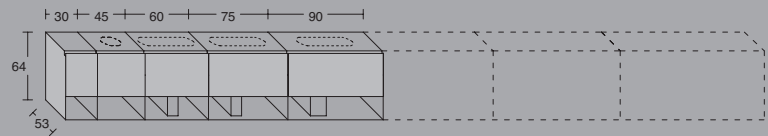
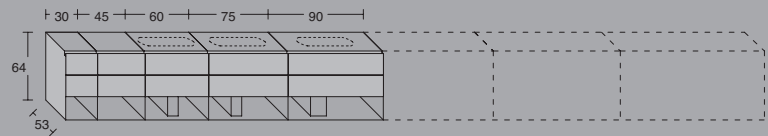
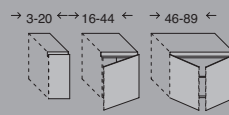
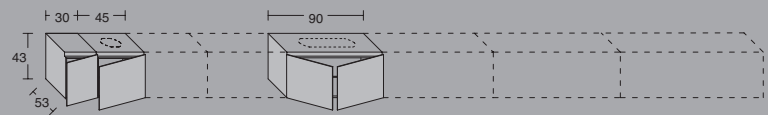
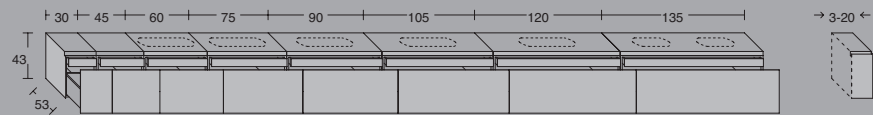
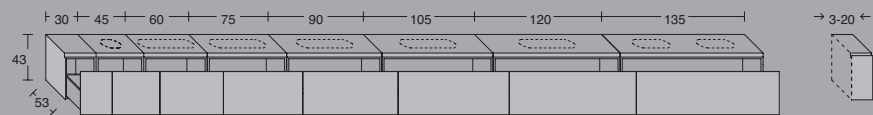
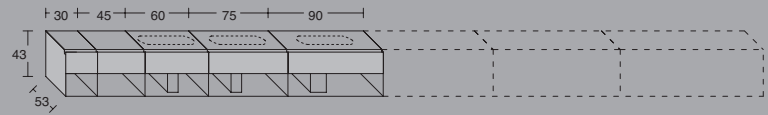
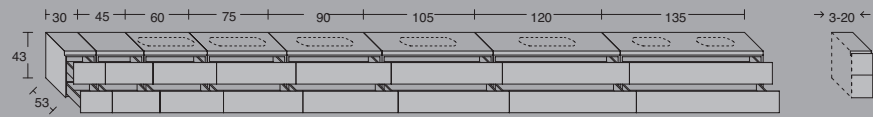
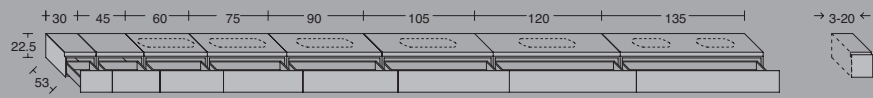

Composition **AL547**

**Monolitepiù Collection**

Top&Basintop

**Opalite Bianco 20**

Cabinet covering

**"Papavero"**

**Seppia 60 / Specchio**

Mirror

**Laser Collection**



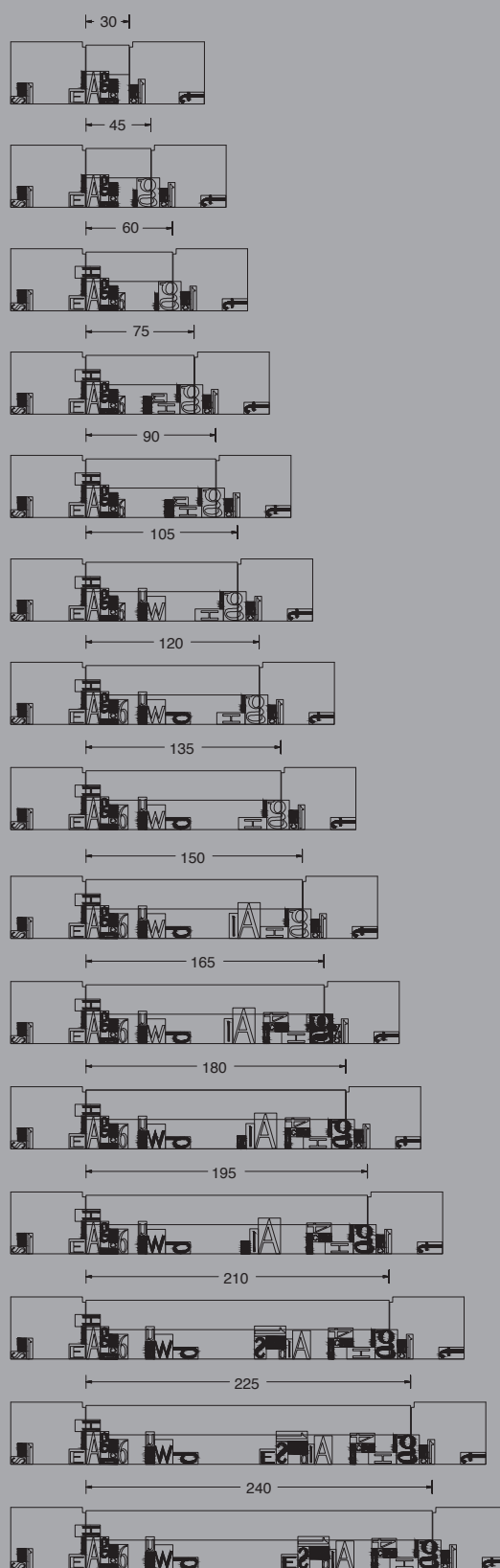
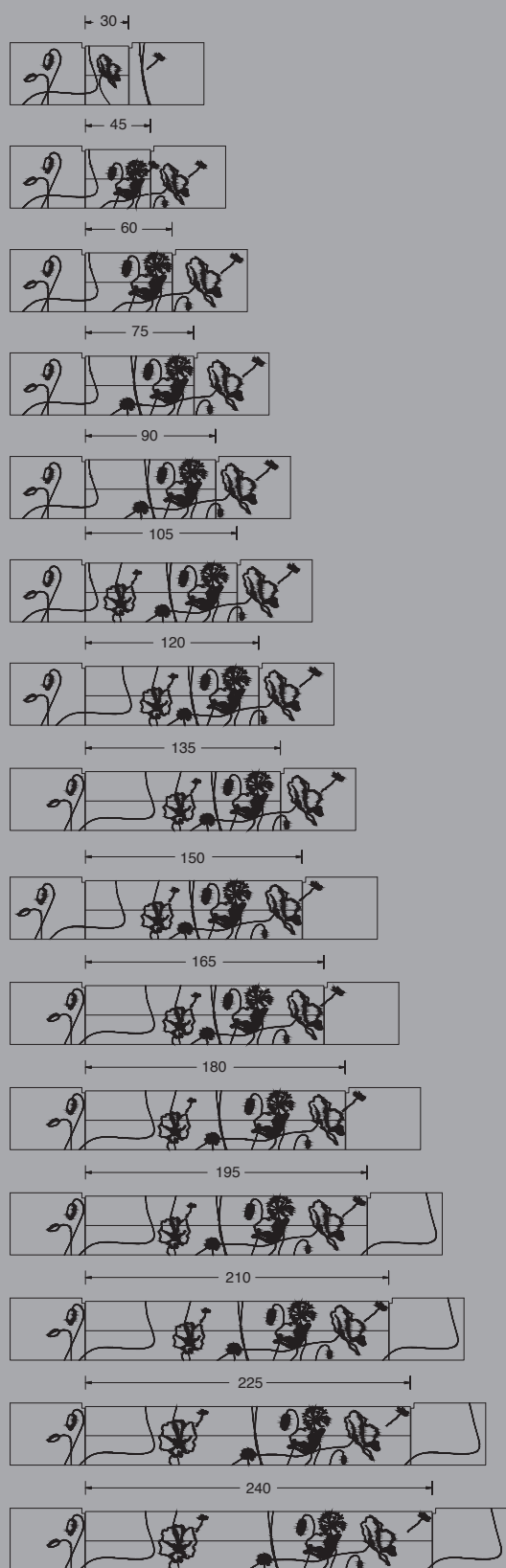

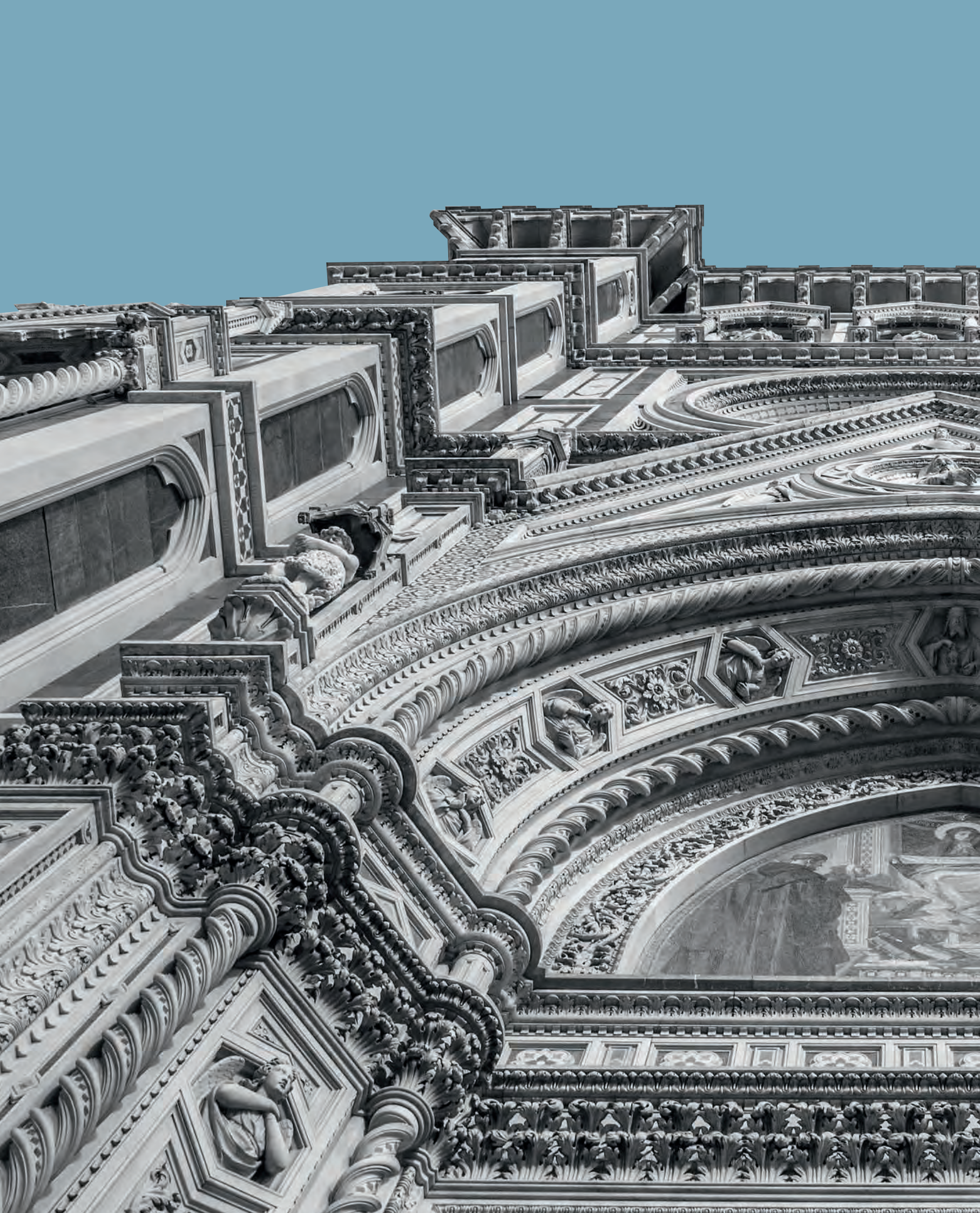

# Domino

La particolarità di Domino è quella di offrire una vasta scelta compositiva, pur essendo elementi monoblocco in Cristallo. Domino e Domino44 si differenziano per la diversa profondità (permettendo di adattarsi alle più svariate esigenze spaziali) e per le caratteristiche delle aperture: dal cassettone ai due cassetti fino al cassetto singolo.

Domino offers a wide choice of combinable units, although its main elements are basin tops and basin units in a pure white finish. Domino and Domino44 are different due to their varying depths thus allowing you to adapt to the most complicated needs of space and design.

La particularité de Domino est d'offrir une grande liberté d'agencement à travers la mise en composition d'éléments MONOBLOC revêtus de verre.

Domino et Domino44 se distinguent par leurs différences de profondeur (53/44 cm), adaptables à tous les espaces, et par la pluralité des modèles : meubles à 1 tiroir, 2 tiroirs, 1 grand caisson.

Die Besonderheit von Domino ist die vielseitige Einrichtungsmöglichkeit, obwohl es um Elemente aus Glas geht.

Der Unterschied zwischen Domino und Domino 44 besteht aus den verschiedenen Tiefen und aus den verschiedenen Ladenelementen - von einer Lade über einen großen Auszug zur Version mit zwei Laden.

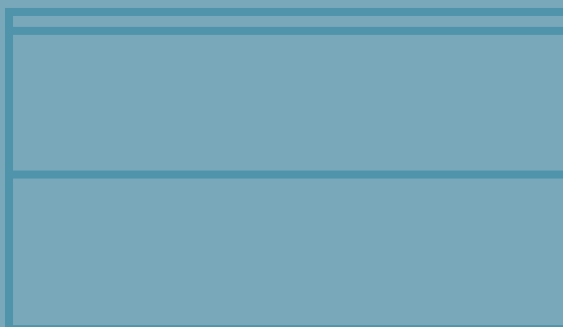





Composition **AL346**

**Domino Collection**

Top&Basintop

**Opalite Bianco 20**

Cabinet covering

**Notte 39**

Mirror

**Led Collection**









Composition **AL347**

**Domino Collection**

Top&Basintop

**Opalite Bianco 20**

Cabinet covering

**Bianco Assoluto 30**

Mirror

**Led Collection**



Composition **AL350**

**Domino Collection**

Top&Basintop

**Opalite Bianco 20**

Cabinet covering

**Bianco Assoluto 30**

Mirror

**Barcode Collection**





Composition **AL349**

Artelinea Collections

**Domino Collection**

Top&Basintop

**Opalite Bianco 20**

Cabinet covering

**Bianco Assoluto 30**

Mirror

**Led Collection**









# Domino44

Per questa collezione è stato pensato un lavabo integrato dalla fusione particolare che permette di sfruttare al meglio tutta la profondità del mobile e di poter usufruire di miscelatori sia da appoggio che a muro.

The Domino 44 has been specially designed to optimise a small space (44 cm) combining its shallow depth with a functional drawer and the option of having a large built-in washbasin and is available with or without tap holes.

Une nouvelle vasque moulée, étudiée spécialement pour cette série, permet d'exploiter au mieux toute la profondeur du meuble et d'installer une robinetterie sur plan ou murale.

Bei dieser letzten Kollektion haben wir zwei neue tief gezogene Becken entwickelt. Das erste asymmetrische Becken ist mit einer Armaturenlochbohrung und das andere rechteckige Becken für eine Wandarmatur erhältlich.



Composition **AL340**

**Domino 44 Collection**

Top&Basintop

**Opalite Bianco 20**

Cabinet covering

**Bianco Assoluto 30/ Erba 63**

Mirror

**Led Collection**









Composition **AL341**

**Artelinea Collections**

**Domino 44 Collection**

Top&Basintop

**Opalite Bianco 20**

Cabinet covering

**Kerlite Road 56**

Mirror

**Led Collection**



Composition **AL343**

**Domino 44 Collection**

Top&Basintop

**Opalite Bianco 20**

Cabinet covering

**Bianco Assoluto 30**

Mirror

**Led Collection**







Composition **AL344**

**Domino 44 Collection**

Top&Basintop

**Opalite Bianco 20**

Cabinet covering

**Bianco Assoluto 30/ Seppia 60**

Mirror

**Led Collection**





Composition **AL345**

**Domino 44 Collection**

Top&Basintop

**Opalite Bianco 20**

Cabinet covering

**Bianco Assoluto 30/ Erba 63**

Mirror

**Led Collection**







# DominoLegno

Il Monoblocco versatile sposa il legno: nuove essenze arricchiscono il programma Domino.

The versatile vanity unit embraces wood. New finishes enrich the Domino style.

Le monobloc polyvalent épouse le bois : de nouvelles finitions enrichissent la série Domino.

Die Vereinigung von vielseitigen Elementen und dem Holz.



**Vintage**



**Fumé**



**Natural**

Composition **AL559**

**Domino Legno Collection**

Top&Basintop

**Opalite Bianco 20**

Cabinet covering

**Natural + Bianco Assoluto 30**

Mirror

**Led Collection**

**Artelinea Collections**





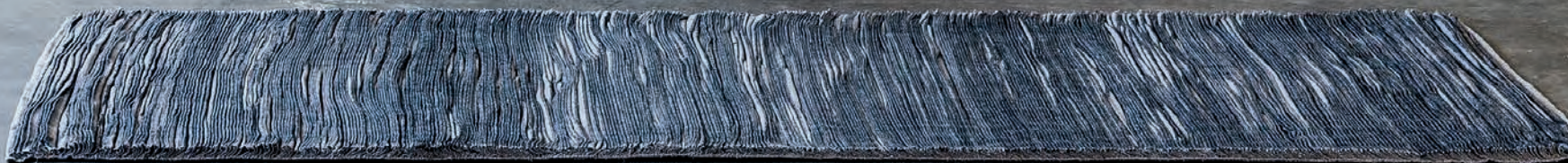

Composition **AL560B**

**Domino Legno Collection**

Top&Basintop

**Opalite Bianco 20**

Cabinet covering

**Fumé**

Mirror

**Laser Collection**







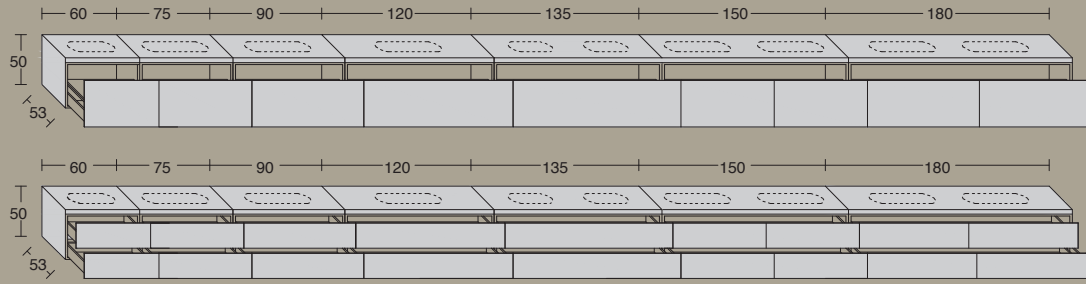

**Domino**

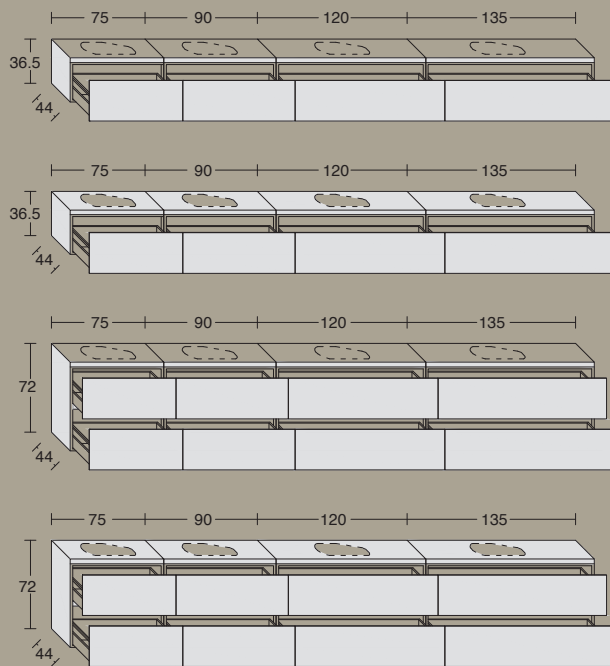

**Domino44**

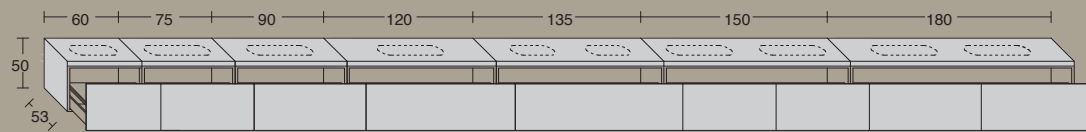

**DominoLegno**



Realizzato completamente in Opalite by Artelinea il bancone Regolo permette di esplorare la libertà espressiva e progettuale nelle dimensioni, nella scelta dei lavabi e negli abbinamenti con altri mobili.

Linee orizzontali e superfici pure sono sottolineate dalla lavorazione dei bordi a 90° e valorizzate dalle caratteristiche del materiale: il tutto per un effetto di "tutto pieno" in Opalite.

Regolo reflects the diversity and the needs of everyday life, exploring compositional possibilities while maintaining the absolute essentiality of Opalite by Artelinea. Freedom in design and planning is possible thanks to a wide choice of sizes and combinable units. Horizontal lines and pure surfaces emphasize the features of the Opalite material including the special 90° bevelled edge finish for obtaining an effect of sturdy Opalite.

Les consoles de la gamme Regolo, entièrement réalisées en Opalite by Artelinea, offrent une liberté d'expression et de conception absolue aussi bien dans le choix des dimensions et des vasques que dans les mises en compositions avec d'autres meubles.

Les lignes horizontales au style épuré sont soulignées par la jonction à 90° des bords de la console et valorisées par les caractéristiques de la matière utilisée, l'opalite, pour un effet pleine masse.

Der Regolo Waschtisch wird komplett in Opalite hergestellt. Es gibt die Möglichkeit Regolo nach Maß, in verschiedenen Breiten, sowie in Kombination mit jedem Becken und anderen Möbeln zu erhalten. Die horizontalen Blenden werden im 90° Winkel mit dem Waschtisch verbunden, wodurch der „alles aus Opalite“ Effekt besonders hervorgehoben wird.

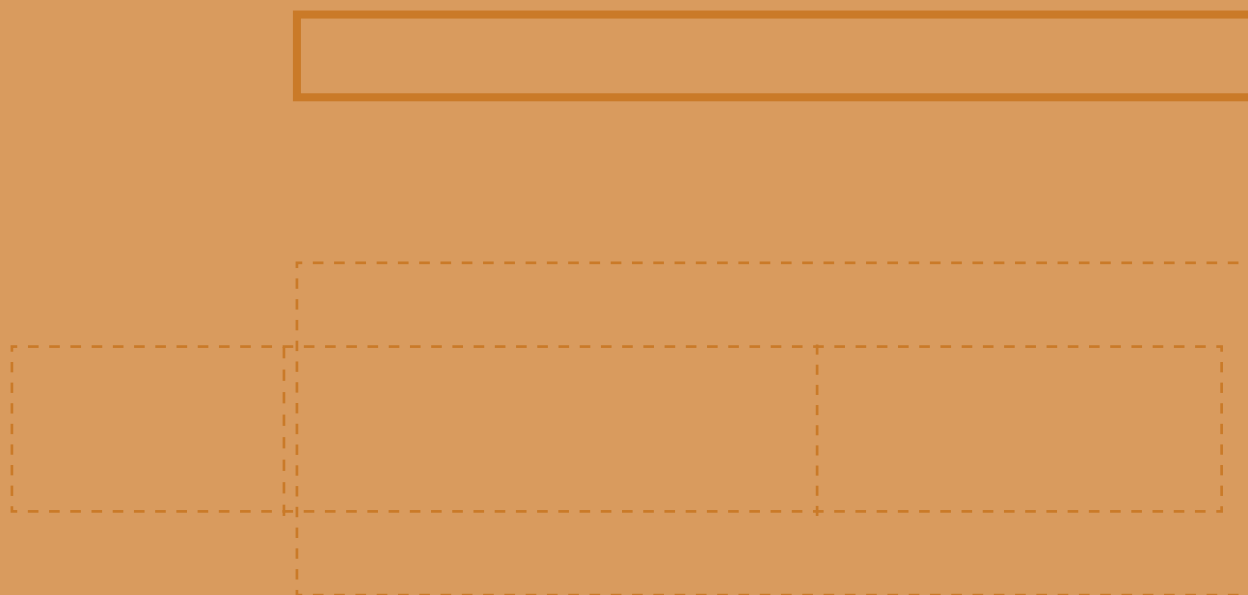



## Regolo

La possibilità di scegliere la lunghezza desiderata da un minimo di 60 cm ad un massimo di 240 cm permette anche di adattare Regolo agli spazi esistenti o di disegnare il proprio spazio in totale libertà. L'abbinamento con lavabi integrati o ad incasso soprapiano (in Opalite bianca o nera) rende Regolo versatile e personalizzabile.

The Regolo counter top is available in a minimum length of 60cm and a maximum length of 240cm. Regolo is adaptable and customizable thanks to different kinds of wash-basins: from basin tops to semi-recessed basins (in white or black Opalite).

D'un minimum de 60 cm à un maximum de 240 cm de longueur, Regolo s'adapte aux espaces existants et permet d'aménager votre salle de bains en toute liberté. Disponible avec vasques intégrées, ou semi-encastées (en Opalite blanc ou noir) Regolo devient une console versatile et personnalisable.

Die Möglichkeit Regolo nach Maß zu nehmen, erlaubt uns die Breite von mindestens 60cm bis 240cm zu bestimmen und somit den Waschtisch passend für Ihre Bedürfnisse herzustellen. Regolo ist weiterhin mit den integrierten-, Halbeinbau- oder Aufsatzbecken kombinierbar, und kann mit Led Technologie beleuchtet werden.



Composition **AL557**

**Regolo + Frammento Collection**

Top&Basintop

**Opalite Nero 24**

Cabinet covering

**Seppia 60**

Mirror

**Flash Collection**



Composition **AL529**

**Regolo + Frammento Collection**

Top&Basintop

**Opalite Bianco 20**

Cabinet covering

**Fumè Glass + Bianco Assoluto 30**

Mirror

**TV Window + Move Collection**





Composition **AL558**

**Regolo + Infra Collection**

Top&Basintop

**Opalite Nero 24**

Cabinet covering

**Bianco Assoluto 30**

Mirror

**Laser Collection**





Composition **AL556**

**Regolo Collection**

Top&Basintop

**Opalite Bianco 20**

Cabinet covering

**Bianco Assoluto 30**

Mirror

**Led Collection**









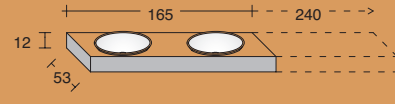
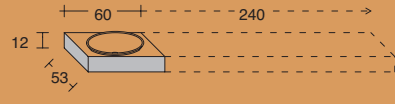
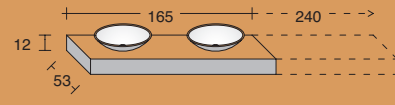
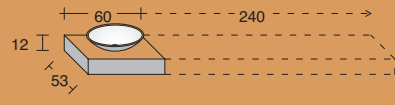
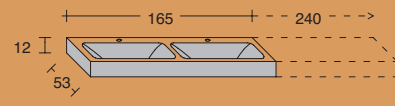
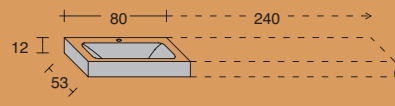



# Incanto

La parte e il tutto, i particolari e il progetto,  
sapienza tecnica addolcita dalla poesia.

The element and the whole, the details and the  
project, technical expertise softened by poetry.

La partie et le tout, les détails et le projet,  
savoir-faire technique adouci par la poésie.

Ein Teil und das Ganze, die Details und das  
Projekt, das technische Know How und die  
Poesie.

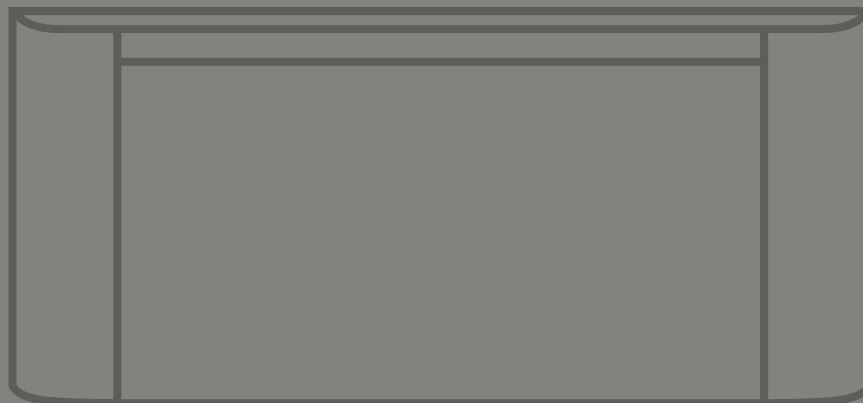



## Incanto

Il vetro come filosofia.  
L'eleganza come missione.

Glass as a philosophy.  
Elegance as a mission.

Le verre pour philosophie.  
L'élégance pour mission.

Glas als Philosophie,  
Eleganz als Mission.



Composition **AL537**

**Incanto Collection**

Top&Basintop

**Avana 45**

Cabinet covering

**Frassino "Canapa" +  
Avana Silk 05**

Mirror

**Incanto Collection**











Composition **AL535**

**Incanto Collection**

Top&Basintop

**Opalite Bianco 20**

Cabinet covering

**Frassino "Cotone"**

Mirror

**Incanto Collection**









ARTELINEA



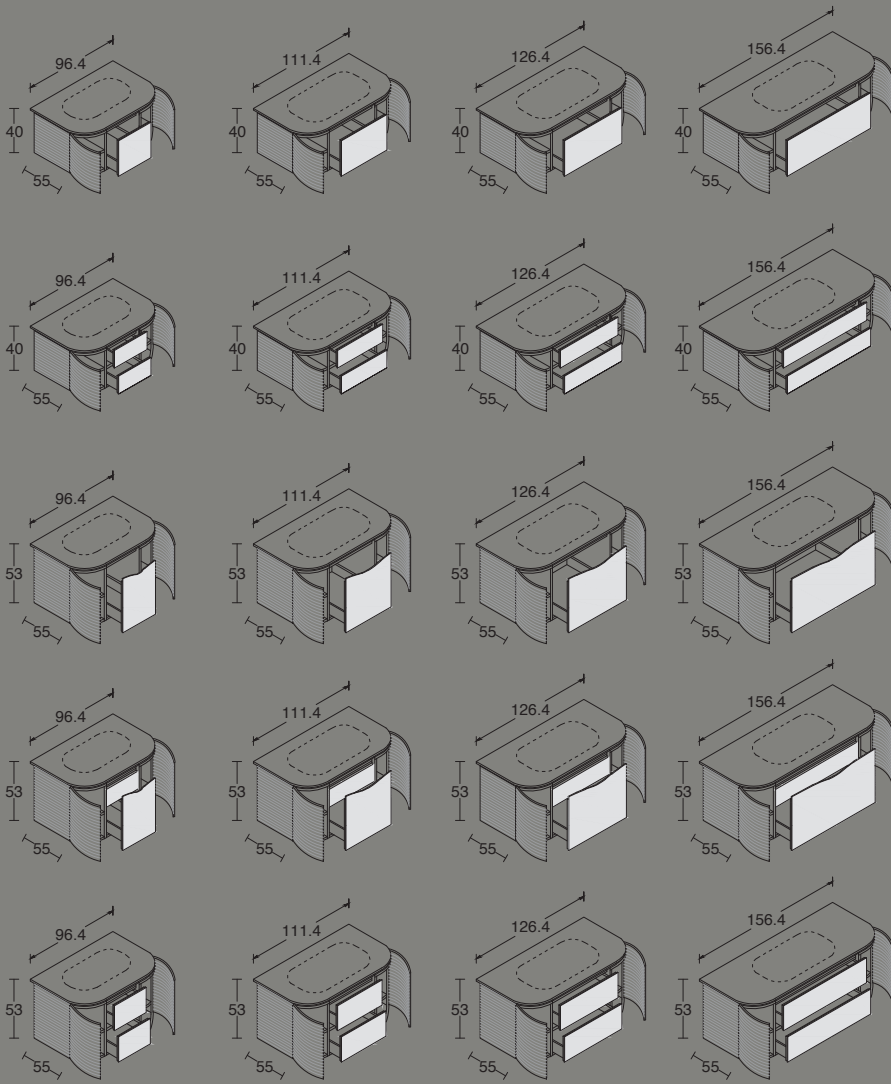





Saper tradurre tradizione e misura in oggetti d'arredo è una prerogativa di Artelinea, azienda che, per vocazione, ricerca continuità e identificazione attraverso l'uso del vetro e, per esperienza, vuole gesti misurati e coerenti nella progettazione e nella realizzazione perché ogni oggetto diventi chiave di lettura di una storia cinquantennale di "ricerca del bello".

Artelinea is a company who has the privilege of knowing how to translate traditions into beautiful bathroom furnishing. We continue to identify areas within our market where glass can be used for measured and consistent designs so that our 50 year search for beauty can continue.

Savoir transmettre la tradition et la mesure dans des objets d'agencement est une prérogative d'Artelinea, société dont la vocation est la recherche de la continuité et de l'identification à travers l'utilisation du verre. « Notre métier impose des gestes mesurés et cohérents afin que toutes nos créations soient la clé de lecture d'une histoire vouée à la recherche de la beauté ».

Die Fähigkeit Formen und Abmessungen in Einrichtungsgegenstände übertragen zu können, gehört zu den Schwerpunkten von Artelinea.

Die Identifikation durch Benutzung von Glas, ständige Weiterentwicklung, Erfahrung und maximale Aufmerksamkeit zum Detail bei der Projektierung sind notwendige Elemente für eine optimale Repräsentation der Geschichte „Entwicklung von Schönheit“





## Kimono

Il valore di Kimono: finiture,  
materiali, ricerca stilistica  
e funzionale.

The value of Kimono: finishes,  
materials, search for design  
and functionality.

Les valeurs de kimono : finitions,  
matière, style recherché,  
fonctionnalité.

Der Wert von Kimono:  
Feinbearbeitung, Materialien,  
stilistische Forschung und  
Zweckmäßigkeit.



Composition **AL581**

**Kimono Collection**

Top&Basintop

**Opalite Bianco 20**

Cabinet covering

**Bianco assoluto 30**

Mirror

**Laser Collection**





Composition **AL582**

**Kimono Collection**

Top&Basintop

**Seppia 60**

Cabinet covering

**Seppia 60**

Mirror

**Laser Collection**









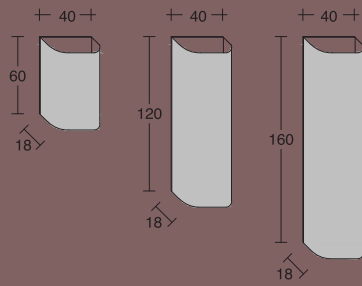
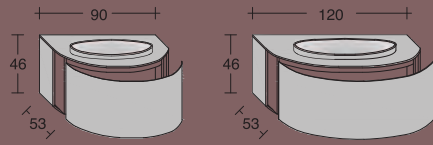
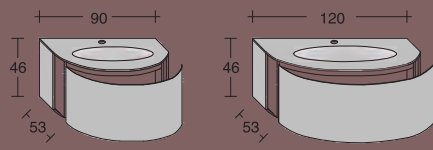



Il monoblocco Decor si presenta come oggetto "prezioso", ricco ma sempre elegante. Le geometrie dei frontali bisellati, i pomoli in cristallo, le gambe in alluminio massiccio oltre a dare spazio alla personalizzazione sottolineano l'unicità del mobile data dalla cura del dettaglio.

The Decor single unit is presented like a "precious" object, rich, customizable and of great elegance. The geometries of the bevelled frontal panels, the crystal handles and the legs in solid polished aluminium highlight the attention to detail and uniqueness of this unit.

Le monobloc Decor, tel une pierre précieuse, témoigne d'une richesse élégante. Les incisions géométriques des façades, les pommeaux en cristal, les piètements en aluminium massif sont des éléments distinctifs personnalisables qui soulignent le caractère unique de chaque meuble.

Das Element Decor präsentiert sich als ein wertvoller, reicher und zeitlos eleganter Einrichtungsgegenstand. Dank der Hingabe zum Detail hebt die Geometrie der gravierten Fronten, die Schraubengriffe aus Kristall und die Beine aus massiven, polierten Aluminium mit Gravuren die Einzigartigkeit des Möbels stark hervor.

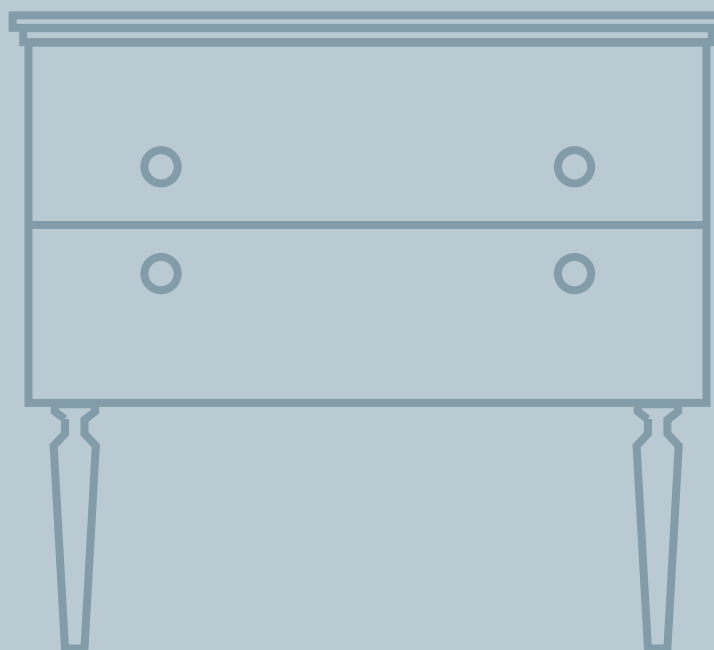



## Decor

Mobile prezioso ed elegante, ricco e curato nei dettagli.

Precious piece of furniture, and elegant, rich and refined details.

Meuble précieux et élégant, richesse des détails.

Wertvolles Möbel, Elegant Jedes Detail wird gepflegt







Composition **AL580**

**Artelinea Collections**

**Decor Collection**

Top&Basintop

**Opalite Bianco 20**

Cabinet covering

**Bianco Assoluto 30**

Mirror

**Liberty Collection**









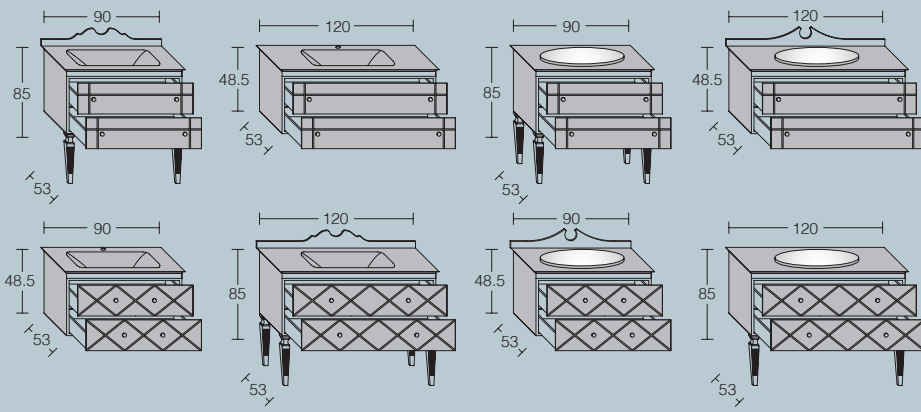



La collezione I Borgia si presenta come una rivisitazione del classico in chiave moderna, una simbiosi tra legno e vetro che trasmette sensazioni e ricordi del passato creando un'atmosfera magica ed ovattata. L'uso di un materiale tecnologico come il vetro, unito ad un materiale caldo come il legno, crea un'alchimia perfetta, dando vita ad una collezione armoniosa dove convivono tendenze moderne con atmosfere retrò.

The collection I Borgia presents the classic with a modern twist, a symbiosis of wood and glass which evokes feelings and memories of the past by creating a magically quiet atmosphere.

The use of a high-tech material such as glass, combined with a warm material such as wood, creates a perfect alchemy, creating a harmonious collection where modern trends live alongside a retro atmosphere.

La collection I Borgia est une relecture moderne des lignes classiques, une symbiose entre bois et Opalite qui divulgue les sensations et les souvenirs du passé dans une atmosphère magique et feutrée.

L'utilisation d'une matière technologique comme l'Opalite et d'une matière chaude comme le bois crée une alchimie parfaite et donne le jour à une collection harmonieuse où cohabitent tendances modernes et ambiances retrò.

Die Kollektion I Borgia präsentiert sich als die Neuinterpretation eines Klassikers.

Die Symbiose zwischen Holz und Glas weckt Gefühle und Erinnerungen an vergangene Tage und bildet eine magische Atmosphäre. Diese harmonische Kollektion verbindet einerseits moderne Züge, hat aber gleichzeitig auch einen Hang zum Retro, was diese Verbindung zu etwas einzigartigem verschmelzen lässt.





## I Borgia

Perfette alchimie di materiali  
e magiche atmosfere

Perfect alchemy of materials and  
a magical atmosphere

Alchimie parfaite des matières  
pour une atmosphère magique

Perfekte Alchemie der Materialien  
und magischen Atmosphäre



Composition **AL531**

**I Borgia Collection**

Top&Basintop

**Opalite Bianco 20**

Legs finish

**Wengè**

Mirror

**I Borgia Collection**







Composition **AL530**

**I Borgia Collection**

Top&Basintop

**Opalite Bianco 20**

Legs finish

**Bianco**

Mirror

**I Borgia Collection**







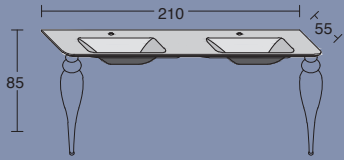
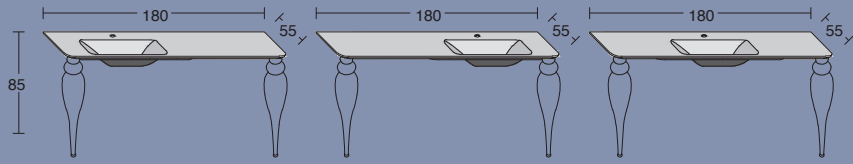
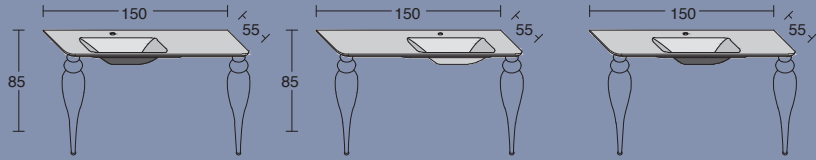
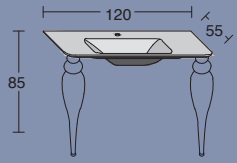



Allusioni sussurrate e ammiccanti suggestioni incontrano la tradizione costruttiva per suggerire un'atmosfera oltre il tempo tra i riflessi del vetro; esplicito rigore ed eloquente semplicità sposano l'eleganza formale per dare significato e valore allo spazio: tutto questo è Metafora.

Coerente con la tradizione Artelinea Metafora riassume la volontà di fare del cristallo un segno distintivo, sottolineandone da una parte la purezza nella versione bianca con lavabo integrato e dall'altra la versatilità nella versione con top in cristallo colorato e lavabo in appoggio.

Whispered allusions and alluring suggestions meet with constructive tradition to create an atmosphere over time, which can be seen in the reflections of the glass mirror. Explicit rigor and eloquent simplicity combine with formal elegance to give meaning and value to the bathroom space, all this is Metafora. Coherent with the tradition of Artelinea, Metafora resumes the will to use crystal to create a distinctive design, emphasizing on one hand the purity of the white version with the integrated wash-basin and on the other hand the versatility of the coloured crystal top with the counter top basin.

Allusions susurrées et suggestions malicieuses rencontrent la tradition constructive pour évoquer une ambiance hors du temps parmi les reflets du verre.

Metafora : rigueur explicite et simplicité éloquente épousent l'élégance formelle pour donner un sens et une valeur à l'espace. En harmonie avec la tradition Artelinea, Metafora emploie le verre comme signe distinctif. Elle en souligne la pureté dans sa version blanche avec vasque moulée et son éclectisme dans la version avec plateau émaillé et vasque à poser.

Formale Eleganz gibt dem Raum eine Bedeutung und Wert: Metafora wird von dieser Eigenschaft charakterisiert. Das weiße Möbel mit dem integrierten Becken hebt einerseits die Reinheit des Glases hervor; Spiegelt aber andererseits auch in Verbindung mit einer Glasplatte aus farbigem Kristall und mit einem Aufsatzbecken ihre Vielseitigkeit wieder.





## Metafora

Connubio attento di legno e vetro, Metafora diventa testimone di una azienda che si caratterizza per lo studio del dettaglio, la sapienza costruttiva, l'attenzione alla versatilità, l'eleganza oltre le mode e lo sguardo sempre attento e stupito.

With the careful combination of wood and glass, Metafora bears witness to a company that is known for its study of detail, constructive knowledge, attention to versatility and elegance beyond fashion.

Union du bois et du verre, Metafora témoigne d'une société reconnue pour son soin du détail, son savoir-faire, son goût pour l'éclectisme, l'élégance intemporelle de ses produits, et son regard attentif et enthousiaste sur le monde.

Verbindung zwischen Holz und Glas; Metafora ist der Zeuge einer Firma, die sich durch Detailarbeit, konstruktivem Wissen, Aufmerksamkeit und Vielseitigkeit sowie Eleganz charakterisiert hat.









Composition **AL533**

**Artelinea Collections**

**Metafora Collection**

Top&Basintop

**Opalite Bianco 20**

Cabinet covering

**Bianco**

Mirror

**Retro Collection**





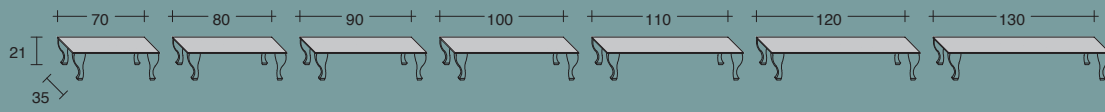
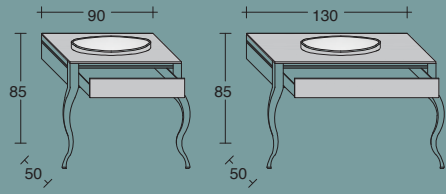
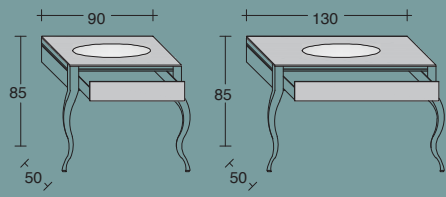





Atollo rivisita il lavabo a mensola utilizzando fusioni in opalite e struttura in MDF idrorepellente impiallacciato o laccato. La versatilità della mensola, unitamente alla possibilità di scegliere tra misure e forme diverse, rendono Atollo facilmente posizionabile in qualsiasi contesto.

Atollo revisits the traditional basin shelf with the use of a fusion basin in Opalite which is supported by a veneered or lacquered hydro repellent MDF structure. The versatility of the shelf, and the possibility to choose different sizes and shapes makes Atollo suitable for any environment.

Atollo est une relecture de la console traditionnelle à travers l'utilisation d'une structure en MDF hydrofuge, plaqué ou laqué, et de vasques moulées en Opalite. La polyvalence de la structure et la possibilité de choisir différentes formes et dimensions de vasques permettent d'installer Atollo dans tous les contextes.

Atollo besteht aus einem integrierten Opalite-Becken und ist mit einer Struktur aus beschichtetem wasserabweisenden Laminat verbunden. Die Möglichkeit, diese Kollektion in verschiedenen Formen und Abmessungen wählen zu können erlaubt es, Atollo in jedem Kontext mühelos zu platzieren.





Composition **AL540**

**Atollo Collection**

Top&Basintop

**Opalite Bianco 20**

Cabinet covering

**Wengé + Bianco**

Mirror

**Atollo Collection**

## Atollo

La collezione, che comprende anche specchi pensati e portasalviette, si presta ad essere accostata a tutti i mobili e le colonne di Artelinea.

This collection, including also mirrors and towel holders, can be combined with all the Artelinea vanity units and columns.

La collection, qui comprend également miroirs et porteserviettes, peut épouser tout meuble et toute colonne de la gamme Artelinea.

Die Kollektion, welche neben dem Becken und der Ablage auch eigens dafür entwickelte Spiegel und Handtuchhalter enthält, kann mühelos mit allen Möbeln und Hochschränken von Artelinea kombiniert werden.



ARIELLEA



Composition **AL543**

**Atollo Collection**

Top&Basintop

**Opalite Bianco 20**

Cabinet covering

**Wengè**

Mirror

**Atollo Collection**





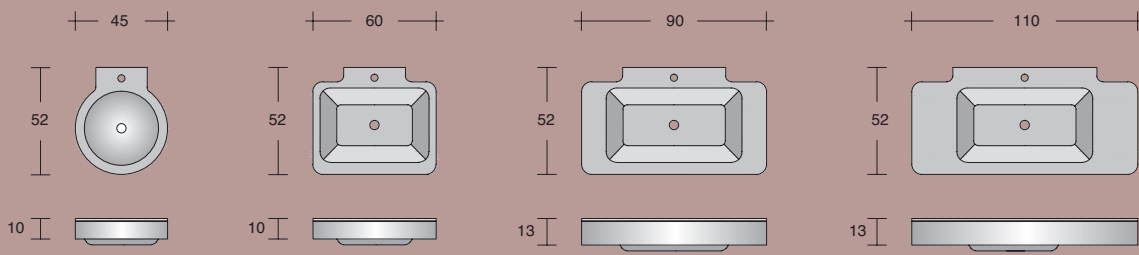

Composition **AL542**

**Atollo Collection**

Top&Basintop

**Opalite Bianco 20**

Cabinet covering

**Wengè**

Mirror

**Atollo Collection**





Struttura lineare e forme pulite. La collezione in acciaio verniciato nero opaco si combina perfettamente con la fusione del basintop di serie proposto in Opalite bianca o nera. Modularità e accessori abbinati, completano questa linea dal gusto contemporaneo.

Linear structure and smooth shapes. This collection in polished opaque black stainless steel combines perfectly with the fusion of the basin top in white or black Opalite. Its modularity and a great variety of accessories complete this contemporary collection.

Structure linéaire et formes simples. La collection, avec structure en acier inox verni noir opaque, se conjugue à la perfection avec son plateau vasque moulée en Opalite blanc ou noir. Sa modularité et ses accessoires complètent cette série aux goûts contemporains.

Eine lineare Struktur und saubere Formen. Die Kollektion vereint perfekt schwarz lackierten Edelstahl mit dem exklusiven Werkstoff Opalite in weiß oder schwarz. Modularität und fein abgestimmte Accessoires komplettieren das zeitgenössische Design.

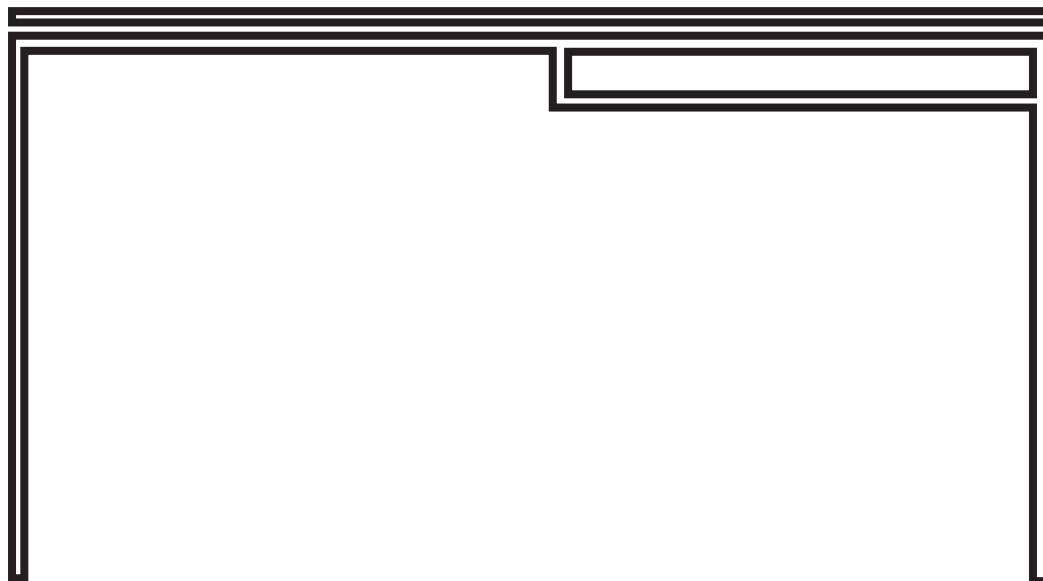

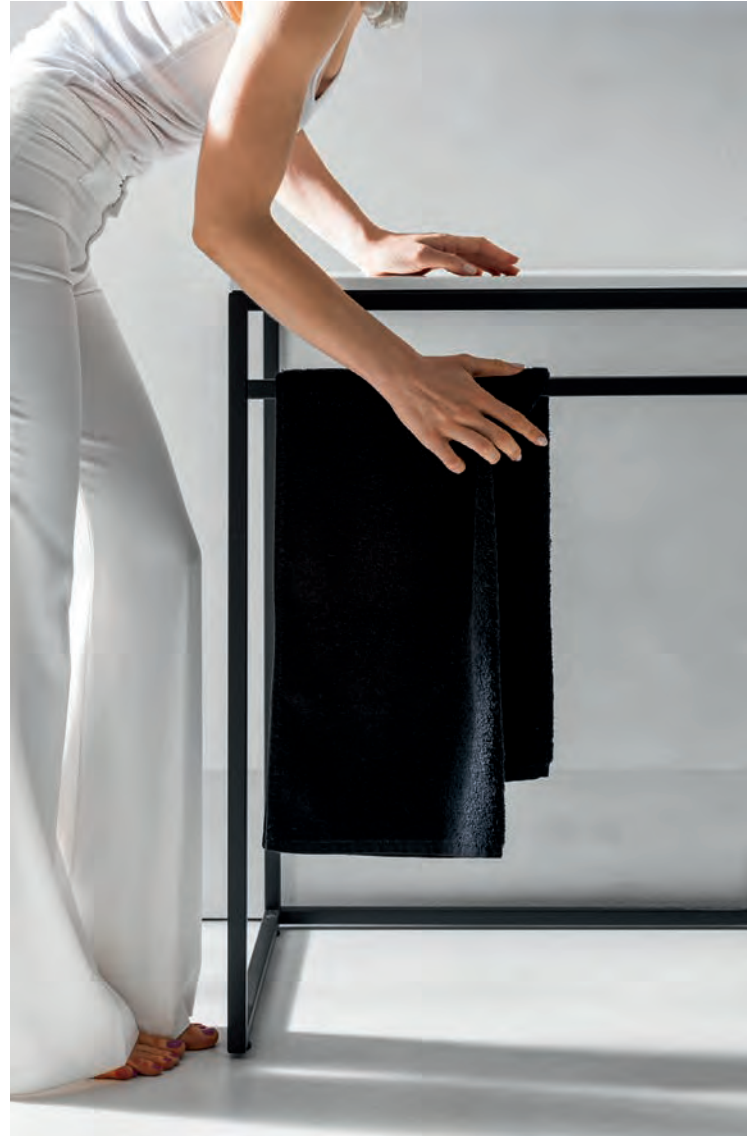

## Frame

Il gesto calibrato si traduce in eleganza.

The calibrated gesture becomes elegance.

Le geste calibré devient élégance.

Die einfachen Linien wirken immer elegant und wertvoll.

Composition **AL553**

**Frame**

Top&Basintop

**Opalite Nero 24**

Mirror

**Box Collection**



Frame

Composition **AL552**

**Frame Collection**

Top&Basintop

**Opalite Bianco 20**

Cabinet covering

**Seppia 60**

Mirror

**Luminee Collection**





Composition **AL554**

**Frame Collection**

Top&Basintop

**Opalite Bianco 20**

Cabinet covering

**Seppia 60**

Mirror

**Move Collection**



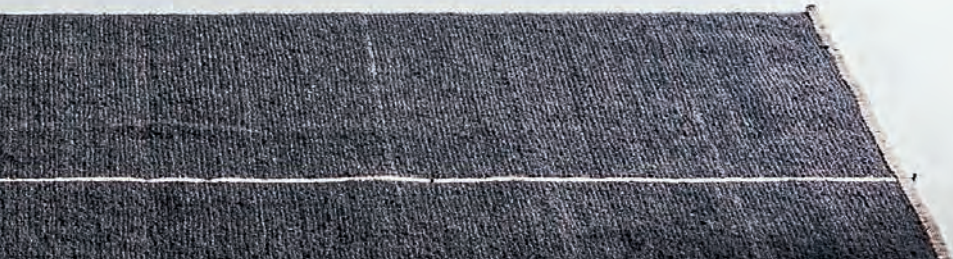





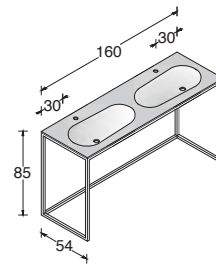
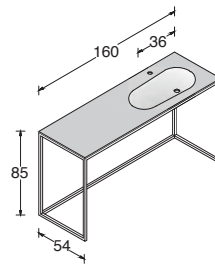
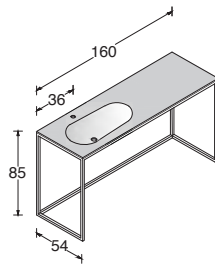
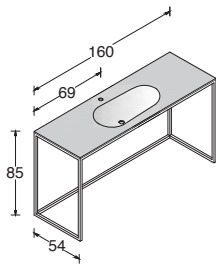
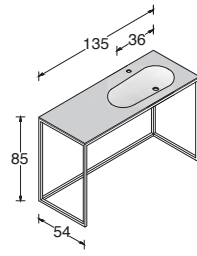
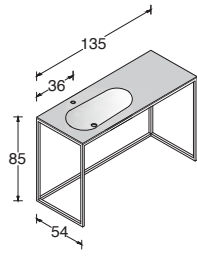
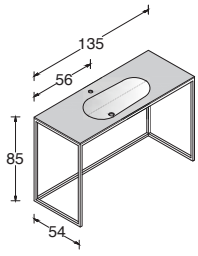
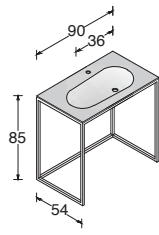
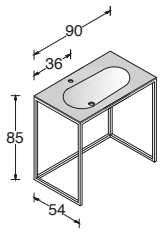



# Bolla

Il vetro nella sua massima espressione: forma e trasparenza. Questa collezione, proposta in acciaio inox verniciato bianco con inserti in Opalite bianco, regala comfort e luminosità all'ambiente bagno. Perfetto l'abbinamento con il lavabo in cristallo trasparente extra-chiaro.

The best example of glass: shape and transparency. This collection, in white polished stainless steel, gives comfort and light to the bathroom. It is perfectly combined with its wash-basin in extra-clear transparent glass.

Le verre dans sa meilleure expression: forme et transparence. Cette série, proposée en acier inox verni blanc, donne confort et luminosité à la salle de bains. Le mariage avec la vasque en verre transparent extra-clair est parfait.

Glas in höchstem Stil: Form und Transparenz. Diese Kollektion, ausgestattet mit weiß lackiertem Edelstahl und weissem Opalite, schenkt dem Badambiente Komfort und Leuchtkraft. Perfekt ist die Verbindung mit dem transparenten Glasbecken.





## **Bolla**

Gioco delle trasparenze e della leggerezza.

Transparency and lightness effects.

Jeu des transparences et de la légèreté.

Durchsichtigkeit und Leichtigkeit.



Composition **AL548**

**Bolla + Infra Collection**

Top&Basintop

**Opalite Bianco 20**

Cabinet covering

**Bianco Assoluto 30**

Mirror

**Oblò Collection**





Composition **AL551**

**Bolla Collection**

Top&Basintop

**Opalite Bianco 20**

Mirror

**Barcode Collection**





Composition **AL549**

**Bolla Collection**

Top&Basintop

**Opalite Bianco 20**

Cabinet covering

**Bianco Assoluto 30**

Mirror

**Broadway Collection**







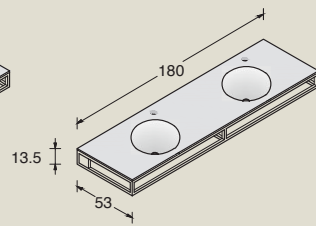
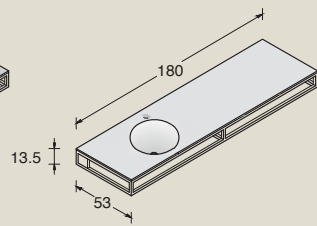
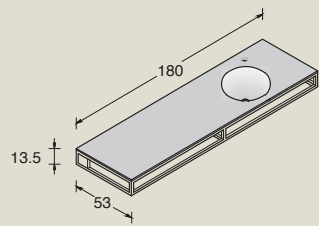
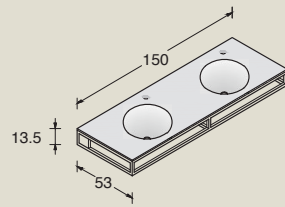
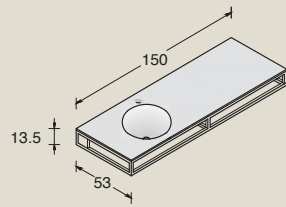
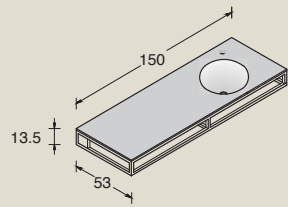
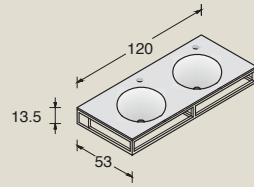
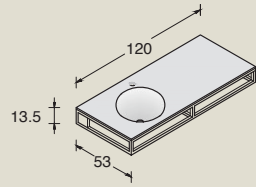
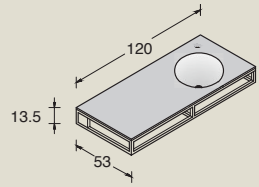
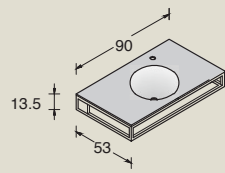
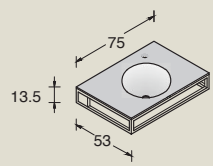



Elegante ma "piccolo": Zen è il mobile da bagno ideale per spazi ridotti e funzionali. Proposto in tutta la gamma colori dei cristalli Artelinea, questa collezione propone un basintop in Opalite o in cristallo smaltato e portasalviette da applicare al fianco del mobile.

Smart and "little": Zen is the ideal bathroom furnishing for small but functional rooms. It can come in all the colours of the Artelinea sample book, this collection can have a basintop in Opalite or in enameled crystal and towel holders to be attached to its sides.

Élégant et "petit": Zen est le meuble de salle de bains idéal pour des espaces réduits, mais fonctionnels. Proposé dans toute la gamme des coloris Artelinea, cette collection propose des plateaux vasque moulée en Opalite et en verre émaillé et des porte-serviettes à appliquer au côté du meuble.

"Klein" aber elegant: Zen ist das perfekte Möbel für reduzierte und funktionelle Räume. Es wird in allen Artelinea-Glasfarben angeboten. Das Basintop ist serienmäßig aus Opalite und der Handtuchhalter wird an der Möbelseite angeschraubt oder aufgeklebt.

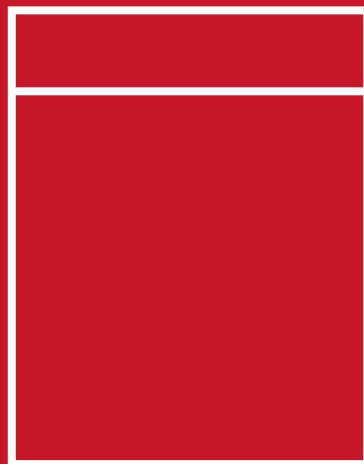



## Zen

Nella semplicità del disegno la risposta alle richieste più "estreme".

In the design simplicity the answer to the more "extreme" requests.

Un design simple pour répondre aux exigences les plus "extrêmes".

Das einfache Design - die Antwort auf "extreme" Anfragen.



Composition **AL561**

**Zen Collection**

Top&Basintop

**Opalite Bianco 20**

Cabinet covering

**Seppia 60**

Mirror

**Zen Collection**



Composition **AL562**

**Zen Top Collection**

Top&Basintop

**Opalite Bianco 20**

Cabinet covering

**Rosso Silk 92**

Mirror

**Zen Collection**



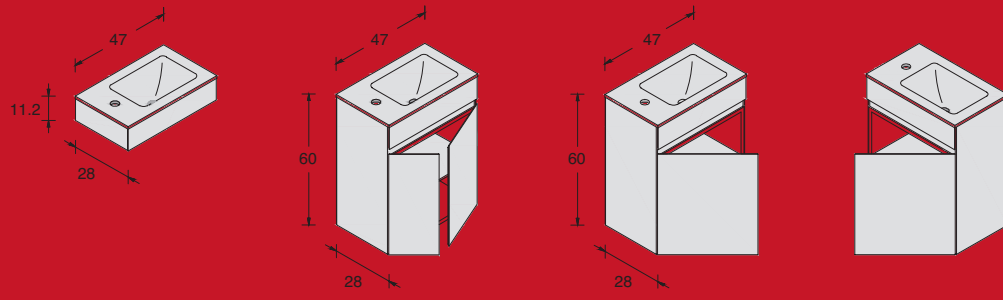







# Accessori e Illuminazione

Lo stile è l'immagine della personalità e ogni bagno racconta chi lo abita. Stili di vita, comfort ed estetica sono al centro delle soluzioni di arredo proposte dai nostri designer. Per qualsiasi richiesta di personalizzazione, agli architetti dedichiamo, inoltre, i nostri servizi di assistenza alla progettazione, rendering e preventivazione.

## Accessories and lighting

Since style reflects personality, bathroom furnishing reflects those who live it. Lifestyles, comfort and aesthetics are the core of the furnishing solutions of our designers. Our staff is able to follow directly each request for customized items, rendered images and quotes in cooperation with our design department.

## Accessoires et éclairage

Le style est l'image de la personnalité et chaque salle de bains raconte ses habitants. Style de vie, confort et esthétique sont au centre des solutions de conception proposées par nos designers. Pour toute demande de personnalisation, nos architectes sont à votre écoute, de même que nos services d'aide à la conception, devis et rendering.

## Zubehör und Beleuchtung

Stil ist das Bild der Persönlichkeit und jedes Badezimmer spiegelt seinen Benutzer wider. Lebensstil, Komfort und Ästhetik stehen im Mittelpunkt der Einrichtungslösungen, die von unseren Designern vorgeschlagen werden. Unsere Berater unterstützen Architekten bei Entwurf, Rendering und Budgetierung der Projektplanung.

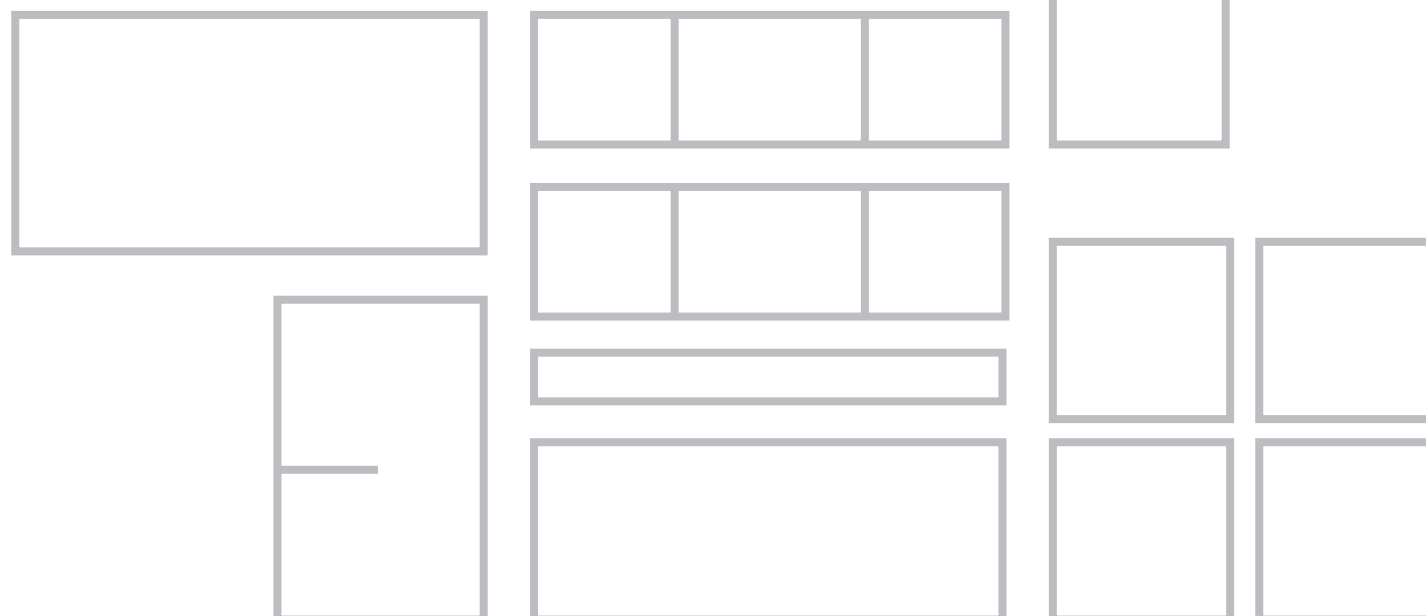

Accessori in acciaio inox  
verniciato nero opaco e inserti  
in Opalite bianco.  
Rif. Listino **Frame Collection**

Accessories in black matt stainless  
steel and inserts in Opalite white.  
Ref. **Frame Collection**

Accessoires en acier inox  
verni noir opaque avec inserts  
en Opalite blanc.  
Réf. Tarif **Frame Collection**

Zubehör aus schwarz matt  
beschichtetem Edelstahl mit Teilen  
aus weissem Opalite.  
Ref. Preislist **Frame Collection**

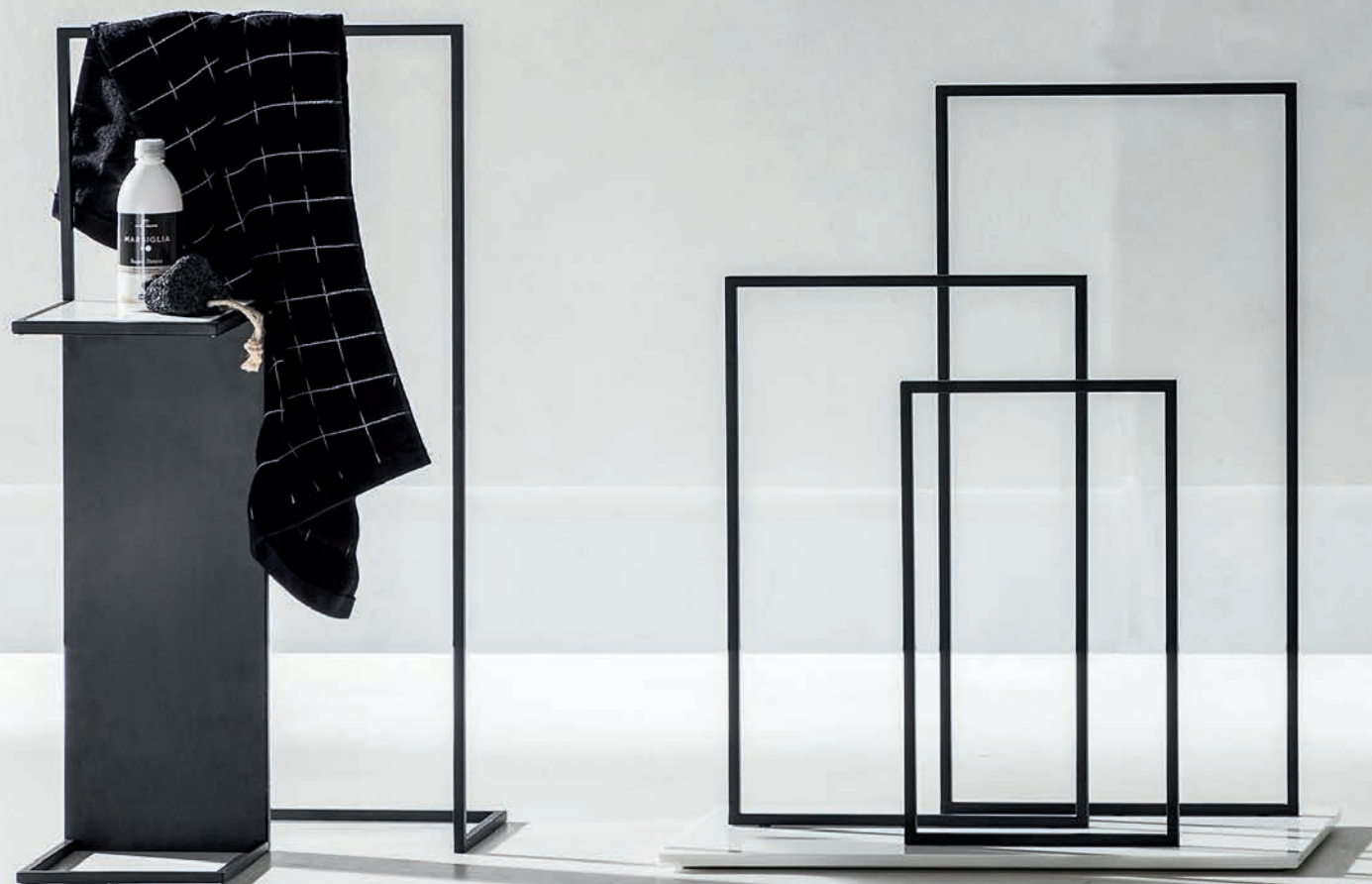
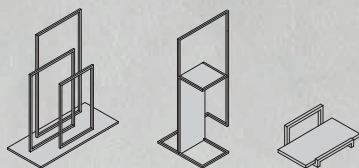





Vetrina pensile in cristallo **dualite®**  
Rif. Listino **Dama Collection**

Wall cabinet in **dualite®** crystal  
Ref. Price-list **Dama Collection**

Étagère suspendue en verre **dualite®**  
Réf. Tarif **Dama Collection**

Vitrine aus Cristallo **dualite®**  
Ref. Preisliste **Dama Collection**

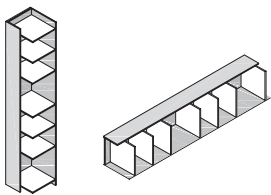

Vetrina pensile a giorno con  
schienale in tutti i colori della cartella  
Rif. Listino **Vetrinette Collection**

Shelf unit with open compartments and  
back in all the colours of our sample book.  
Ref. Price-list **Vetrinette Collection**

Étagère suspendue, fond dans tous les  
coloris de notre nuancier.  
Réf. Tarif **Vetrinette Collection**

Offenes Glasregal mit Rückwand in jeder  
Farbe der Farbtabelle  
Ref. Preisliste **Vetrinette Collection**

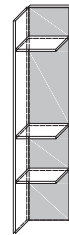

Vetrina pensile a scomparti  
e mensole intermedie  
Rif. Listino **Vetrinette Collection**

Cabinet with sections  
and dividing shelves  
Ref. Price-list **Vetrinette Collection**

Meuble de rangement avec  
compartiments équipés d'étagères  
transparentes.  
Ref. Tarif **Vetrinette Collection**

Vitrine mit Ablagen  
Ref. Preisliste **Vetrinette Collection**

Vetrina pensile in cristallo **dualite®**  
Rif. Listino **Dama Collection**

Wall cabinet in **dualite®** crystal  
Ref. Price-list **Dama Collection**

Étagère suspendue en verre **dualite®**  
Réf. Tarif **Dama Collection**

Vitrine aus Cristallo **dualite®**  
Ref. Preisliste **Dama Collection**

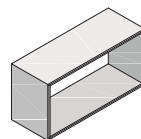
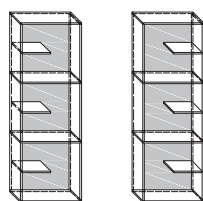

Vetrina con telaio in acciaio inox verniciato bianco e mensole in cristallo extrachiaro  
Rif. Listino **Bolla Collection**

Shelves in extra-clear crystal and frame in white polished stainless steel  
Ref. Price-List **Bolla Collection**

Meuble de rangement avec structure en acier verni blanc et étagères en verre extra clair.  
Réf. Tarif **Bolla Collection**

Vitrine aus Cristallo Dualite  
Ref. Preisliste **Bolla Collection**

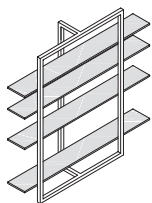

Colonna sx o dx con 2 scomparti e 2 ante, vano a giorno e 3 ripiani interni in vetro trasparente.  
Rif. Listino **Colonne Collection**

Left or right column with 2 sections and 2 doors, open compartment and 3 internal shelves in transparent glass.  
Ref. Price-list **Colonne Collection**

Colonne Sx ou Dx avec 2 portes, 1 compartiment métallique et 3 étagères intérieures en verre transparent.  
Réf. Tarif **Colonne Collection**

Hochschrank sx oder dx mit 2 Türen, offenem Fach und 3 Ablagen aus transparentem Glas  
Ref. Preisliste **Colonne Collection**



Accessori in opalite bianco e ottone cromato.  
Rif. listino **Vetrinette Collection**

Accessories in white opalite and chromed brass.  
Ref. Price-list **Vetrinette Collection**

Accessoires en Opalite Bianco et laiton chromé.  
Réf. Tarif **Vetrinette Collection**

Zubehör aus weissem Opalite und verchromtem Messing  
Ref. Preisliste **Vetrinette Collection**

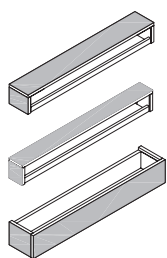

Pannelli di rivestimento in Opalite bianco con cornici, mensoline e divisori in cristallo extrachiaro  
Rif. Listino **Summa Collection**

Covering panel in white Opalite with frames, shelves and dividers in extra-clear crystal.  
Ref. Price-list **Summa Collection**

Panneaux de revêtement en Opalite blanc avec encadrement, étagères et séparateurs en verre extra-clair.  
Réf. Tarif **Summa Collection**

Wandverkleidung aus Opalite weiss mit Rahmen, Ablagen oder Einteilungen aus transparentem Glas.  
Ref. Preisliste **Summa Collection**

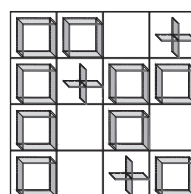

Pensile con struttura in grigio scuro con anta a ribalta e maniglia rivestito in cristallo  
Rif. Listino **Dama Collection**

Wall unit with dark grey structure, door flap and handle with crystal covering.  
Ref. Price-list **Dama Collection**

Étagère avec structure gris foncé, porte à abattant et poignée, revêtue de verre.  
Réf. Tarif **Dama Collection**

Hängeschrank mit Struktur in dunkelgrau und Tür mit Glas verkleidet.  
Ref. Preisliste **Dama Collection**

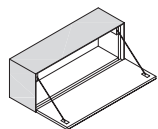

Vetrina pensile a giorno.  
Rif. Listino **Vetrinette Collection**

Hanging wall unit with open  
compartments.  
Ref. Price-list **Vetrinette Collection**

Étagère avec séparateurs  
Réf. Tarif **Vetrinette Collection**

Ablage  
Ref. Preisliste **Vetrinette Collection**

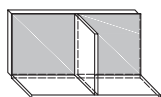

Colonna con struttura in cristallo **dualite**<sup>®</sup>,  
ripiani in cristallo extrachiario e anta rivestita  
in cristallo.  
Rif. Listino **Dama Collection**

Wall unit with structure in **dualite**<sup>®</sup>,  
door and open compartments with shelves  
in 8mm extra-clear crystal.  
Ref. Price-list **Dama Collection**

Colonne avec structure en **dualite**<sup>®</sup>,  
une porte et trois étagères en verre  
extra-clair épaisseur 8 mm.  
Réf. Tarif **Dama Collection**

Hochschrank mit Korpus aus Cristallo  
**dualite**<sup>®</sup>, mit einer Glas verkleideten Tür  
und offenen Fächern aus transparentem Glas.  
Ref. Preisliste **Dama Collection**

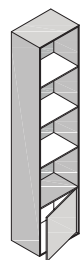

Portariviste  
Rif. Listino **Dama Collection**

Magazine rack  
Ref. Price-list **Dama Collection**

Porte-magazines  
Réf. Tarif **Dama Collection**

Zeitschriftenablage  
Ref. Preisliste **Dama Collection**

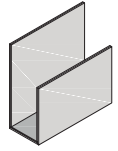

Portariviste  
Rif. Listino **Dama Collection**

Magazine rack  
Ref. Price-list **Dama Collection**

Porte-magazines  
Réf. Tarif **Dama Collection**

Zeitschriftenablage  
Ref. Preisliste **Dama Collection**

**Artelinea Collections**

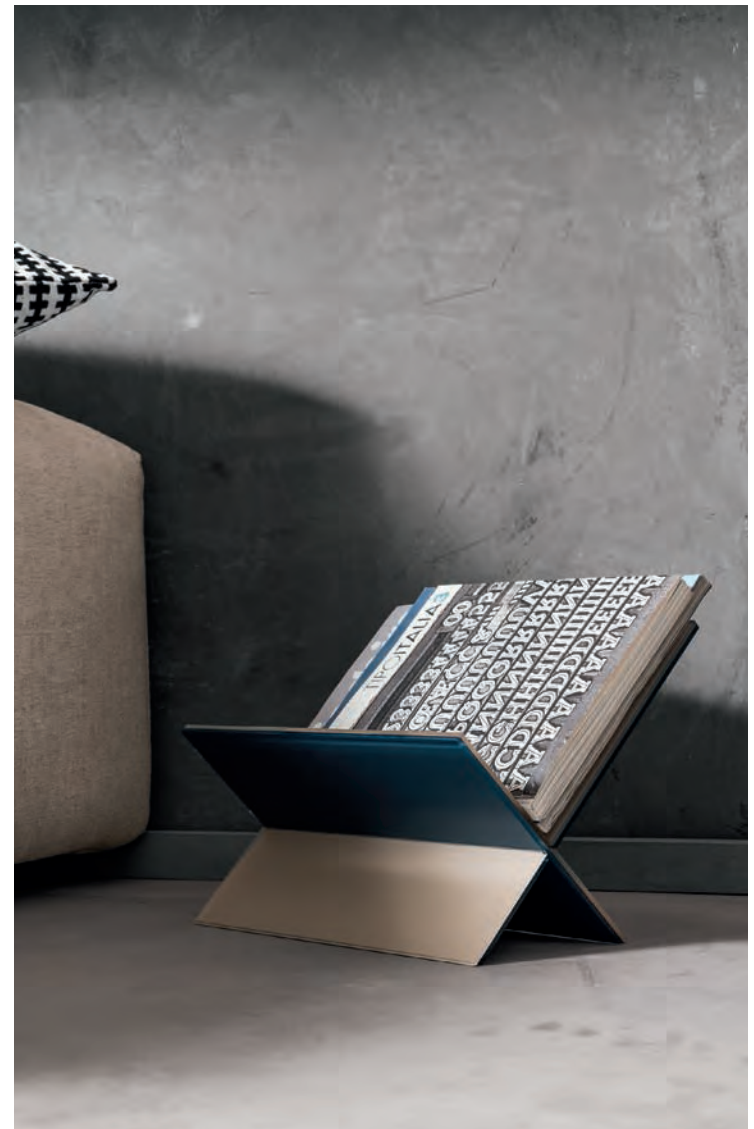
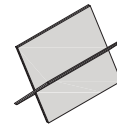



Carrello in cristallo **dualite**<sup>®</sup>  
e ripiano in cristallo extrachiaro  
Rif. Listino **Dama Collection**

Cabinet on wheels in **dualite**<sup>®</sup>  
crystal, shelf in extra-clear crystal.  
Ref. Price-list **Dama Collection**

Desserte en **dualite**<sup>®</sup> avec  
étagère en verre extra-clair  
Réf. Tarif **Dama Collection**

Rollcontainer aus **dualite**<sup>®</sup> und  
Ablagen aus transparentem Glas  
Ref. Preisliste **Dama Collection**



Mobile portaoggetti in cristallo **dualite**<sup>®</sup>  
con ripiano in cristallo extrachiaro  
Rif. Listino **Dama Collection**

Floor standing column with  
**dualite**<sup>®</sup> crystal inserts and  
shelves in extra-clear crystal  
Ref. Price-list **Dama Collection**

Colonne porte-objets à poser  
au sol avec inserts en **dualite**<sup>®</sup>.  
Étagères en verre extra-clair  
Réf. Tarif **Dama Collection**

Stehender Gegenstandsträger aus  
Cristallo **dualite**<sup>®</sup> mit Ablagen aus  
transparentem Glas  
Ref. Preisliste **Dama Collection**

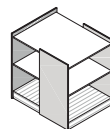

Panca porta accessori in cristallo **dualite®** e 2 gambe in Frassino  
 Rif. Listino **Dama Collection**

Bench for accessories in **dualite®**  
 crystal with 2 legs in ash  
 Ref. **Dama Collection**

Porte-accessoires en **dualite®**,  
 piètements en frêne  
 Réf. Tarif **Dama Collection**

Gegenstandsträger aus **dualite®**  
 mit 2 Füßen aus Eschenholz  
 Ref. Preisliste **Dama Collection**

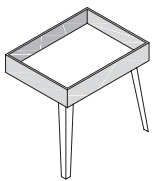



Soluzioni immediate e profonde, lontane dall'ovvietà, in armonia con la casa, la persona e la natura.  
I faretti possono essere applicati a parete, allo specchio, a soffitto, in alternativa alle plafoniere.  
I materiali proposti sono l'acciaio inox, il plexiglass, il policarbonato, il cristallo o lo specchio.  
Le luci sono led, alogene o neon.



## Move Collection

Lampade scorrevoli e rimovibili.  
Vertical sliding, removable lamps.  
Appliques verticales coulissantes  
et amovibles  
Vertikale Beleuchtungsmittel, abnehmbar

### Lighting

Immediate, deep, and not obvious solutions, in harmony with houses, with people and with nature. Spotlights can be attached to the wall, to the mirror, to the ceiling as an alternative to the ceiling lights. The materials are stainless steel, plexiglass, polycarbonate, crystal and mirror with LEDs, halogen or neon lights.

### Éclairage

Des solutions immédiates et profondes, loin d'être évidentes, en harmonie avec la maison, la personne et la nature. Les appliques peuvent être installées sur les murs, les miroirs, les plafonds, comme une alternative aux plafonniers. Les matériaux proposés sont l'acier inoxydable, le Plexiglas, le polycarbonate, le verre ou le miroir. Les éclairages sont à LED, halogènes ou à néons.

### Beleuchtung

Sofortige und tiefgreifende Lösungen, weit entfernt vom Offensichtlichen, in Harmonie mit Haus, Person und Natur. Die Strahler können an der Wand, dem Spiegel, der Decke, oder alternativ an der Leiste angebracht werden. Die vorgeschlagenen Materialien sind Edelstahl, Plexiglas, Polycarbonat, Glas oder Spiegel. Beleuchtung mit LED Lampen, Halogen oder Neon.

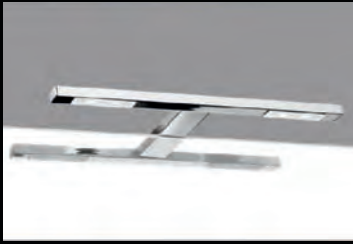



# Materiali e tecnologie

Disegnare un prodotto equivale a disegnare una relazione. È questo pensiero che ci guida nella selezione dei materiali e nella soddisfazione delle esigenze delle persone, che ogni giorno nelle loro case entrano in contatto con i nostri prodotti.

## **Materials and technologies**

Designing a product means designing a relation. This thought leads us in selecting materials for meeting the needs of those people who come into contact with our products every day.

## **Matériaux et technologies**

La conception d'un produit équivaut à dessiner un rapport. C'est cette pensée qui nous guide dans le choix des matériaux et la satisfaction des besoins des personnes qui, chaque jour, dans leurs maisons sont en contact avec nos produits.

## **Materialien und Technologien**

Ein Produkt zu entwerfen ist wie die Gestaltung einer Beziehung. Dieser Gedanke leitet uns bei der Auswahl der Materialien und bei den Bemühungen, die Menschen zufriedenzustellen, die jeden Tag zu Hause mit unseren Produkten in Kontakt kommen.

Marcello ha iniziato nel 1957, ancora bambino, ad argentare il vetro per trasformarlo in specchio. Appresa l'arte, a diciotto anni si è posto l'obiettivo di diventare imprenditore. Da allora ha continuato a produrre specchi, introducendo continue novità. Grazie ai figli Massimo e Marco, oggi la sperimentazione e la ricerca di soluzioni tecniche dialogano con lo studio delle esigenze contemporanee. Gli specchi sono interamente prodotti, montati e cablati dal nostro personale specializzato.

### **Mirrors. Hands, ideas and passion**

Marcello started plating the glass for transforming it in mirrors in 1957, when he was just a young man. At eighteen, after having become an expert, Marcello aimed at becoming a businessman. Since then, he has continued producing mirrors thus introducing continuous innovations. Thanks to his sons, Massimo and Marco, today experimentation and research of technical solutions are supported by the study of the contemporary needs. Mirrors are entirely manufactured, assembled and wired by our skilled staff.

### **Miroirs. Mains, idées, passion**

C'est dès son enfance, en 1957, que Marcello a commencé à argenter le verre pour le transformer en miroir. Une fois cet art maîtrisé, à dix-huit ans, il se fixe pour objectif de devenir un entrepreneur. Dès lors, il a continué à produire des miroirs, en introduisant des innovations constantes. Aujourd'hui, grâce à ses fils Massimo et Marco, l'expérimentation et la recherche de solutions techniques interagissent avec l'étude des besoins contemporains. Les miroirs sont entièrement fabriqués, assemblés et câblés par notre personnel spécialisé.

### **Spiegel. Hände, Ideen, Leidenschaft**

Marcello begann als Kind, im Jahre 1957, Glas zu versilbern, um es dann in einen Spiegel zu verwandeln. Als er diese Kunst erlernt hatte, setzte er sich mit achtzehn Jahren das Ziel, Unternehmer zu werden. Seitdem produziert er Spiegel und entwickelt sie kontinuierlich neu. Dank seiner Söhne Massimo und Marco interagieren heute Experimente und die Suche nach technischen Lösungen mit dem Studium der Bedürfnisse der heutigen Zeit. Die Spiegel werden komplett von unserem Fachpersonal gefertigt, montiert und verkabelt.





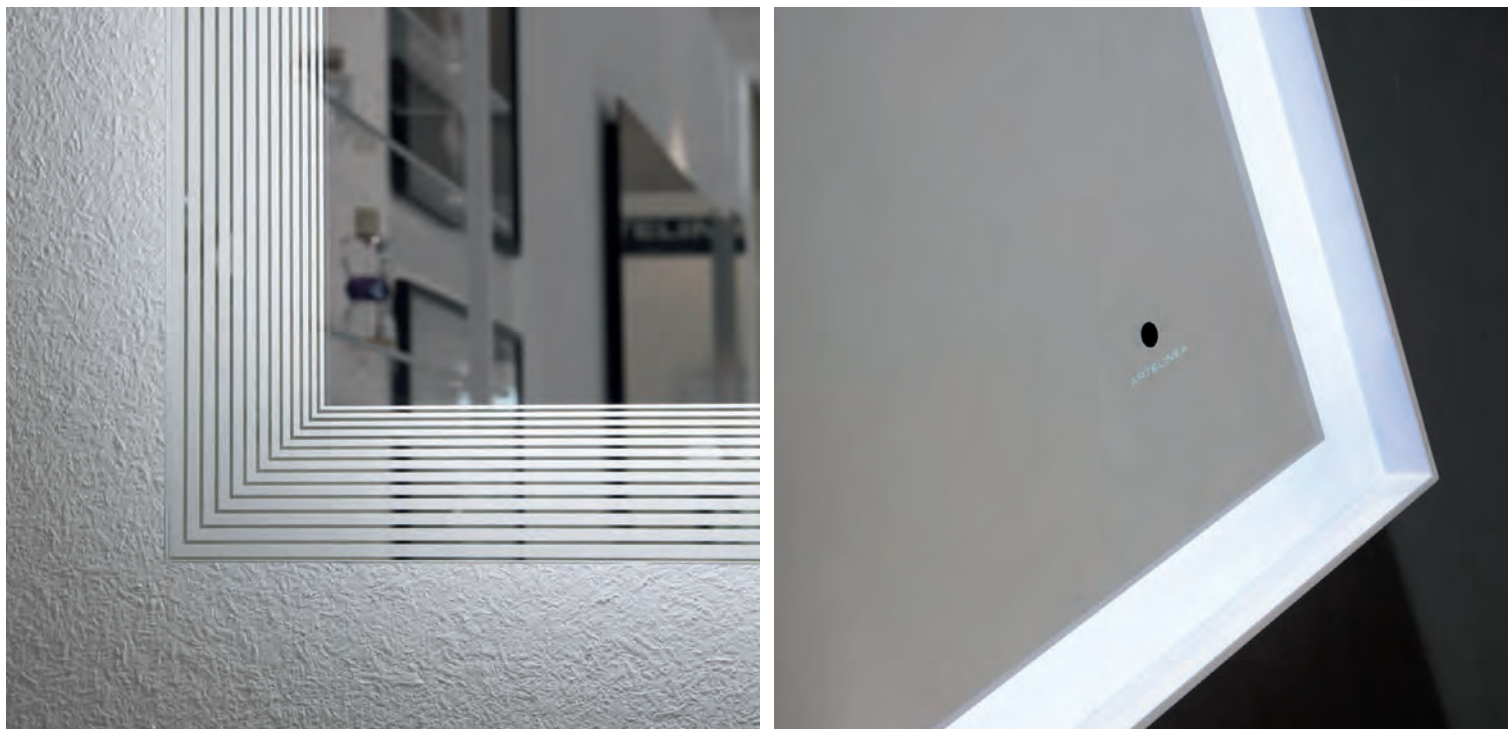

**Fresatura e incisione laser**

I bordi degli specchi sono molati a filo lucido, a toro, a becco di civetta o a bisello per eliminare qualsiasi asperità e ottenere una lucidatura perfetta. Le cornici possono essere luminose, in doppio cristallo o con perimetro lavorato al laser.

**Milling and laser engraving**

Our mirrors have smooth, rounded, thumbnail or bevelled edges, they are not sharp and they are perfectly polished. Frames can be bright, in double glass or with laser engraving.

**Biseaux et gravure au laser**

Les bords des miroirs sont biseautés pour obtenir des bords droits, en bec d'aigle ou en biseau pour éliminer toute rugosité et obtenir un polissage parfait. Les cadres peuvent être éclairés, en double verre ou avec des bords incisés au laser.

**Fräsen und Lasergravur**

Die Kanten der Spiegel sind feingeschliffen, stumpf, abgerundet oder facettiert, um jede Unebenheit zu beseitigen und den perfekten Glanz zu erzeugen. Die Rahmen gibt es hell, mit doppeltem Kristall oder mit einer Umrandung in Laserverarbeitung.

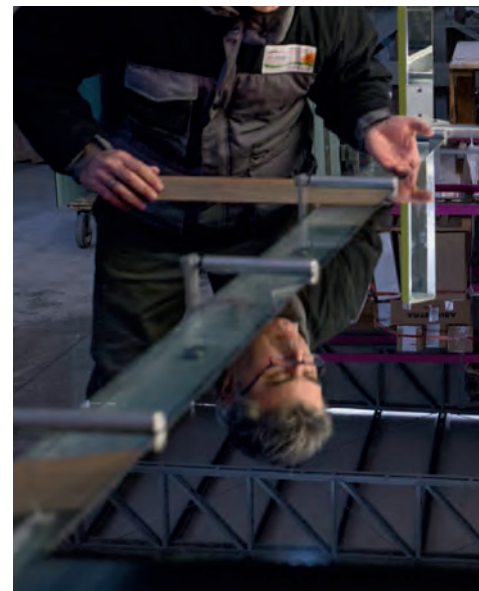

Godere di una straordinaria qualità degli elementi presenti nella stanza da bagno rappresenta la differenza nel quotidiano di ciascuno. Per questo l'illuminotecnica è al centro delle nostre soluzioni: gli specchi sono illuminati con lampade led a luce naturale, fredda o calda, retroilluminati o dotati di illuminazione integrata.

### Technology at the forefront

Enjoying high quality bathroom furnishing makes the difference in one's daily life. That is why lighting engineering is at the core of our solutions: mirrors are enlightened with spotlights, natural, cold or warm LED lighting, or with LED diffused lighting.

### Une technologie de pointe

Profiter d'une qualité exceptionnelle des éléments dans la salle-de-bains est une différence dans le quotidien de chacun. Ceci est la raison pour laquelle l'éclairage est au cœur de nos solutions : les miroirs sont éclairés avec des lampes LED à lumière naturelle, froide ou chaude, rétro-éclairés ou équipés d'un éclairage intégré.

### Hochmoderne Technologie

Die außergewöhnliche Qualität der Badezimmer-elemente genießen zu können, macht den Unterschied im Alltag eines Jeden aus. Aus diesem Grund steht die Beleuchtung im Mittelpunkt unserer Lösungen: Spiegel-Beleuchtungen mit LED-Lampen mit warmem oder kaltem Licht, Hintergrundbeleuchtung oder integrierte Beleuchtung.



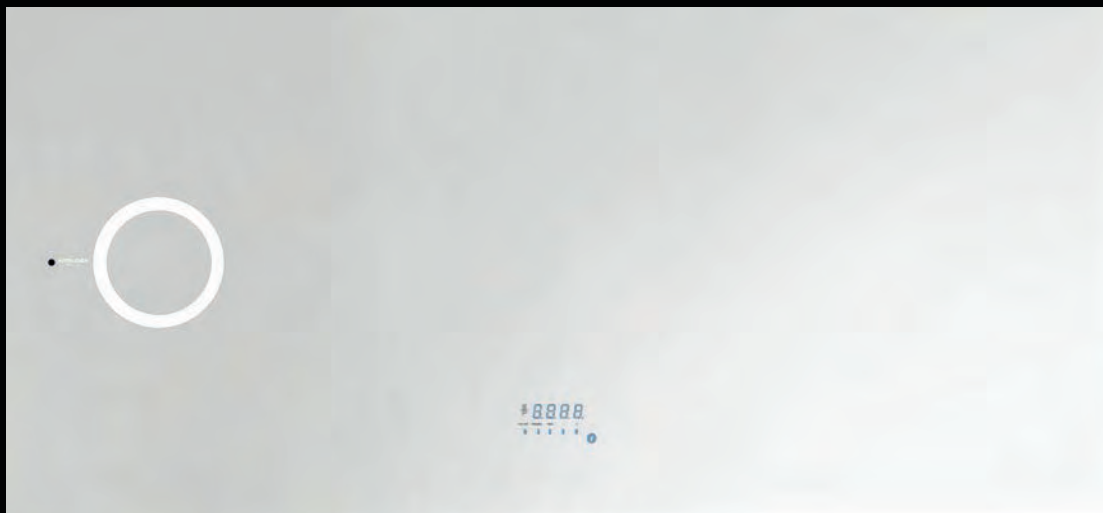

#### ILLUMINAZIONE DIFFUSA

Per un benessere totale, l'illuminazione è integrata su due o quattro lati, oppure diffusa sul retro dello specchio. Artelinea produce modelli esclusivi a luce RGB.

#### ILLUMINAZIONE CON FARETTO

In cristallo o policarbonato trasparente, il faretto diffonde luce led o luce neon.

#### NO FOG

Il sistema anti-appannamento permette di utilizzare lo specchio anche in condizioni di alta umidità.

#### TELEVISIONE

Sul retro dello specchio è applicata una smart TV che non pregiudica l'argentatura della superficie.

#### MUSICA

Grazie alla funzione Bluetooth® e a innovativi "shaker" montati sullo specchio, ascoltare la musica salvata nel proprio smartphone è immediato.

#### MULTIMEDIA

Orologi digitali, altoparlanti Bluetooth®, pulsanti a sfioramento, luci led a bassissimo consumo trasformano la vivibilità della stanza da bagno.

#### SENSOR

Sugli specchi sono montati interruttori sensor frontali e laterali, dimmer o superlight per il pieno controllo dell'intensità della luce.

#### DIFFUSED LIGHTING

For a total well-being, our mirrors have integrated lighting on two or four sides or on the rear side. Artelinea creates exclusive mirrors with RGB lighting.

#### LIGHTING WITH SPOTLIGHT

In crystal or transparent polycarbonate, the spotlight spreads LED or neon light.

#### NO FOG

The no-fog system allow us to use the mirror even in rooms with a high humidity level.

#### TELEVISION

A smart TV is attached in the rear side of the mirror; this does not damage the mirror plating.

#### MUSIC

Thanks to the Bluetooth® device and to the shakers attached to the mirror, you can immediately listen to the music saved in your smartphone.

#### MULTIMEDIA

Digital clocks, Bluetooth® speakers, sensor switches, low-energy led lighting improve your bathroom atmosphere.

#### SENSOR

Sensor, dimmer or super-light options are assembled on our mirrors for a better control of the light intensity.

#### ÉCLAIRAGE D'AMBIANCE

Pour un bien-être total, l'éclairage est intégré sur deux ou quatre côtés, ou à l'arrière du miroir. Artelinea produit des modèles exclusifs à lumière RGB.

#### APPLIQUE

En verre ou en polycarbonate transparent, l'applique diffuse de la lumière LED ou de la lumière néon.

#### NO FOG

Ce système anti-buée permet d'utiliser le miroir, même dans des conditions d'humidité élevée.

#### TÉLÉVISION

Une Smart TV de 22" est appliquée au dos du miroir sans en altérer l'argenture en surface.

#### MUSIQUE

Grâce à la fonction Bluetooth® et aux haut-parleurs montés sur le miroir, vous pouvez instantanément écouter de la musique stockée sur votre smartphone.

#### MULTIMEDIA

Horloges numériques, haut-parleurs Bluetooth®, touches tactiles, ampoules LED basse consommation transforment la qualité de vie dans la salle-de-bains de la salle de bains.

#### SENSOR

Sur les miroirs, des sensors frontaux, dimmer ou superlight sont montés pour le contrôle de l'intensité lumineuse.

#### DIFFUSE BELEUCHTUNG

Für das vollkommene Wohlbefinden ist die Beleuchtung entweder auf zwei oder vier Seiten integriert, oder auf der Rückseite des Spiegels angebracht. Artelinea produziert exklusive Modelle mit RGB Beleuchtung.

#### BELEUCHTUNG MIT STRAHLERN

Der Strahler aus Kristall oder transparentem Polycarbonat beleuchtet mit LED- oder Neonlampen

#### NO FOG

Durch das Antibeslagsystem kann der Spiegel auch bei hoher Luftfeuchtigkeit benutzt werden.

#### FERNSEHER

Auf der Rückseite des Spiegels ist ein Smart TV angebracht, das die Versilberung der Oberfläche nicht beeinträchtigt.

#### MUSIK

Dank Bluetooth® und innovativem "Shaker" Lautsprecher auf der Spiegeloberfläche ist es möglich, die auf dem Smartphone gespeicherte Musik über den Spiegel wiederzugeben.

#### MULTIMEDIA

Digitaluhren, Bluetooth® -Lautsprecher, Touch-Tasten, Lampen und Leds mit geringem Verbrauch machen die Benutzung des Badezimmers zu einem Erlebnis.

#### SENSOR

Front-oder Seitensensorschalter, Dimmer oder Touch-Light auf den Spiegeln gewährleisten die Kontrolle der Beleuchtungsstärke.

## Design e illuminazione. Sistemi di illuminazione integrati

Artelinea Collections



power led



spot led



led band

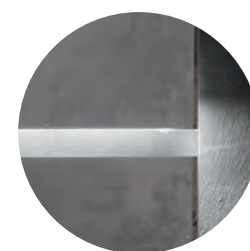

led diffusion

I nostri specchi sono dotati di una sorgente luminosa intensa ma diffusa per evitare l'abbagliamento. L'illuminazione sui quattro lati o la retroilluminazione a luce naturale, fredda o calda è garantita da luci led ad alta efficienza luminosa e di lunga durata.

Ad ampliare i progetti di arredo, specchi extrachiaro con cornici luminose o con cornici perimetrali impreziosite da lavorazioni laser.

### Design and lighting Integrated lighting system

Our mirrors have an intense and diffused luminous source, but not a dazzling light. Natural, Cold or warm LED lighting or led diffusion are guaranteed by long-lasting LED lights with high energy efficiency. Mirrors can have bright or laser engraving frame.

### Design et éclairage Systèmes d'éclairage intégrés

Nos miroirs sont équipés d'une source de lumière intense, mais diffuse pour éviter l'éblouissement. L'éclairage sur les quatre côtés ou le rétro-éclairage avec une lumière naturelle, froide ou chaude est assuré par des ampoules à LED à haute efficacité lumineuse et longue durée. Pour développer les projets d'agencement, des miroirs extra-clairs avec cadres lumineux ou cadres ornés de décorations au laser.

### Design und Licht Integrierte Beleuchtungssysteme

Unsere Spiegel sind mit einer intensiven, aber streuenden Lichtquelle ausgestattet, um Blendung zu vermeiden. Die Beleuchtung an allen vier Seiten oder die Hintergrundbeleuchtung mit kaltem oder warmem Licht wird durch LED Lichtelemente mit hoher Leuchtfähigkeit und langer Lebensdauer garantiert. Zusätzlich bieten sich extraklare Spiegel mit leuchtenden oder perimetrischen Rahmen an, die durch Laserbearbeitung verschönert werden.



**Cornice luminosa**

Sul retro dello specchio, lungo il perimetro, sono installati sensori, trasformatore e strisce led, protetti all'interno di una scatola-contenitore.

**Bright frame**

Sensor switches, transformer and led bands are installed behind the mirror and the electrical components are protected and sealed in a box.

**Cadre lumineux**

Sur l'arrière du miroir, le long du périmètre, des capteurs, un transformateur et des bandes à LED, protégées dans un boîtier, sont installés.

**Heller Rahmen**

Entlang dem Rahmen auf der Rückseite des Spiegels sind Sensoren, der Transformator und LED-Streifen angebracht, die durch ein Gehäuse geschützt sind.

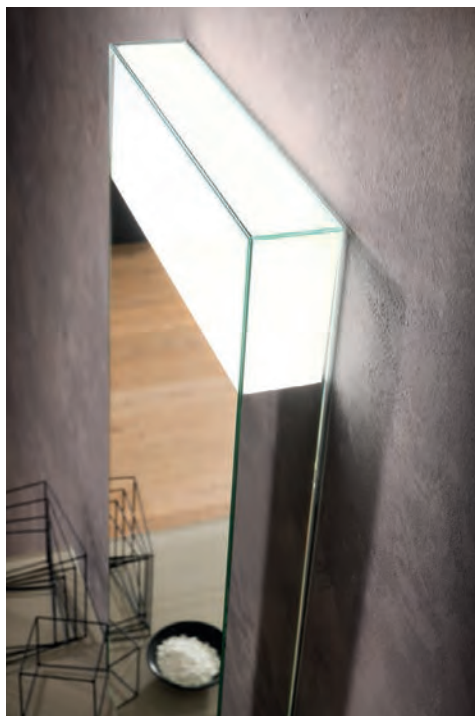

**Lampade integrate allo specchio**

Una finestra retroilluminata da lampade led a luce fredda o calda si inserisce nella linea geometrica dello specchio, offrendo una luminosità diffusa e di carattere.

**Mirror lighting**

Cold or warm lighting are integrated in the geometric line of the mirror offering a diffused lighting of great character.

**Éclairages intégrés aux miroirs**

Une fenêtre rétro-éclairée par des ampoules à LED à lumière froide ou chaude s'insère dans la ligne géométrique du miroir, offrant une luminosité diffuse et apportant une touche de caractère.

**Im Spiegel integrierte Lampen**

Ein Fenster, das mit Led-Lampen mit kaltem oder warmem Licht von hinten beleuchtet ist, passt in die geometrische Linie des Spiegels und bietet eine diffuse Beleuchtung mit Charakter.



**Mensole in vetro**

Coordinate agli specchi, mensole d'appoggio in vetro costituiscono un punto di illuminazione scenografico e al tempo stesso discreto.

**Lighted glass shelves**

Glass shelves are matched with mirrors to create a lighting point.

**Etagères en verre**

Coordonnées aux miroirs, les étagères en verre constituent un point d'éclairage scénographique et en même temps discret.

**Beleuchtete Glaskonsolen**

Auf die Spiegel ausgelegte Glaskonsolen bilden eine szenografische und gleichzeitig diskrete Beleuchtung.

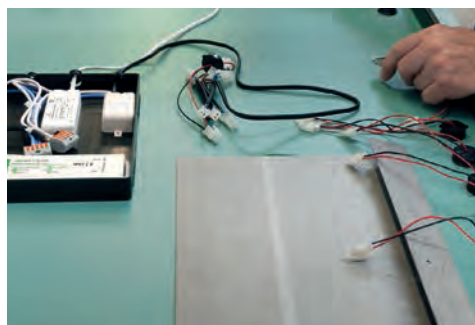

# opalite

L'Opalite®, nome a marchio Artelinea, è un innovativo materiale risultato dalla fusione controllata di un'irripetibile formulazione di sabbia silicea e altri minerali nobili. Tale amalgama di pasta bianchissima, completamente priva di resine, solventi o altre sostanze artificiali, mutua le sue caratteristiche peculiari da due degli elementi costituenti la ricetta di base: la componente silicea attribuisce lucentezza e brillantezza eccezionali, la componente minerale la rende particolarmente resistente a graffi e urti.

Quest'unica ricetta di fabbricazione consente il suo impiego per rivestimenti e pavimenti.

L'uniformità di Opalite, unitamente alle nostre tecniche per termoformarla e personalizzarla, valorizzano ogni progetto di arredamento del bagno, dai lavabi integrati ai bordi vasca, dai top ai gradini fino alle consolle.

Opalite®, Artelinea's trademark, is an innovative material resulting from the controlled fusion of a unique formulation of silicon sand and other noble minerals. This mixture of extra white paste is completely free of resins, solvents and other artificial materials. Opalite® obtains its peculiar characteristics from two of its main components: the silicon particles, which give it exceptional sparkle and brilliance, and the mineral element, which makes it resistant to scratches and hits.

This special production recipe allows us to use this material for covering and flooring.

The homogeneity of the Opalite along with the techniques we use for customizing and thermoforming it give value to each project of bathroom furnishing, from basin tops to bath edgings, from tops to steps to hanging wash-basins.

Opalite®, nom déposé par la marque Artelinea, est un matériau innovant résultant de la fusion contrôlée d'une formulation unique de sable de silice et d'autres minéraux précieux. Cet amalgame de pâtes blanches, exempt de résines, de solvants ou d'autres substances artificielles, doit ses caractéristiques particulières à deux des éléments constituant la recette de base : le composant à base de silice donne un éclat et une brillance exceptionnels au produit, le composant minéral le rend particulièrement résistant aux rayures et aux chocs. Cette recette unique de fabrication permet son utilisation pour les revêtements muraux et de sol. L'uniformité d'Opalite alliée à nos techniques pour la thermoformer et la personnaliser, apportent de la valeur ajoutée à tout projet de décoration pour la salle de bains, des vasques aux habillages de baignoires, des plateaux aux consoles.

Opalite®, ein eingetragener Markenname von Artelinea, ist ein innovatives Material welches durch die einzigartige kontrollierte Fusion von Siliziumteilchen und anderen Edelmetallen entsteht. Diese Mischung ist komplett frei von Harzen, Lösungsmitteln oder anderen künstlichen Materialien. Opalite erlangt seine speziellen Eigenschaften durch zwei seiner Hauptbestandteile: die Siliziumteilchen verleihen dem Material den einzigartigen Glanz, die Mineralkomponente macht das Material resistent gegen Kratzer und Stöße. Diese einzigartige Rezeptur erlaubt es Opalite zum Beispiel als Fußbodenbelag zu verwenden. Die Große Farbpalette, mit der Opalite kombiniert werden kann, gepaart mit der Homogenität und der Technik des Thermoformens verleihen jedem Badezimmer-Projekt einen sehr hohen Wert, angefangen von Basintops, über Wannenverkleidungen, bis hin zu Tops, Stufenverkleidungen und Ablagen.



## RESISTENZA

L'amalgama di sabbia silicea e altri minerali nobili dona a Opalite una singolare compattezza che proprio nell'uso quotidiano manifesta la sua inesauribile valenza.

### Resistance

The mixture of silicon sand and other noble minerals give Opalite a unique compactness shown in the everyday usage.

### Résistance

L'amalgame de sable de silice et d'autres minéraux précieux donne à Opalite une compacité singulière qui s'avère précieuse au quotidien.

### Widerstand

Die keramische Komponente gemischt mit dem Glaselement gibt Opalite eine einzigartige Festigkeit, die gerade für den alltäglichen Gebrauch von unschätzbarem Wert ist.



Opalite nasce dalla cristallizzazione di polveri di ceramica e silicio, materiali riciclabili e privi di resine, solventi o altre sostanze nocive.

### Ecology

Opalite is produced from the crystallization of ceramic and silicon powders, reusable materials free of resins, solvents, or other harmful substances.

### Écologie

Opalite naît de la cristallisation des poudres de céramique et de silice, matériaux recyclables et exempts de résines, solvants ou autres substances nocives.

### Ökologie

Opalite entsteht durch die Kristallisation von Keramikpulver und Silizium, recycelbaren Materialien, frei von Harzen, Lösungsmitteln oder anderen schädlichen Substanzen.



## ECOLOGIA

## ELEGANZA

Un'estetica contemporanea: la superficie riflette la luce in modo uniforme; le linee sono l'esito di una progettazione su misura.

### Elegance

A contemporary aesthetics: the surface reflects light uniformly; lines are the result of a customized design.

### Élégance

Une esthétique contemporaine: la surface réfléchit la lumière de manière uniforme; les lignes sont le résultat d'une conception sur mesure.

### Eleganz

Eine moderne Ästhetik: Die Oberfläche reflektiert das Licht gleichmäßig; die Linien sind das Ergebnis eines maßgeschneiderten Designs.

## IGIENE

Opalite ha una superficie non porosa che la rende inattaccabile da muffe o batteri. Per preservarne le qualità nel tempo, è sufficiente l'impiego di prodotti non abrasivi per superfici lavabili.

### Product care

Opalite surface is non-porous, that is why this material is resistant to mildew and bacteria. The usage of non-abrasive cleaning products for washable surfaces is highly recommended for preserving Opalite qualities over time.

### Hygiène

Opalite a une surface non poreuse qui la rend résistante aux moisissures ou aux bactéries. Pour en préserver la qualité dans le temps, il suffit d'utiliser des produits non-abrasifs pour les surfaces lavables.

### Hygiene

Opalite hat eine spiegelglatte Oberfläche, die es gegen Schimmel oder Bakterien resistent macht. Damit die Qualität langfristig erhalten bleibt, genügt die Verwendung von nicht-abrasive Produkten für abwaschbaren Oberflächen.

Le caratteristiche di Opalite sono i valori che ne motivano la scelta: il materiale è completamente ecologico e riciclabile ma soprattutto è inattaccabile da muffe e batteri per l'assenza di porosità. La sua compattezza e l'assoluta resistenza lo rendono adatto alle sollecitazioni d'uso, compresi graffi e urti. La stabilità chimica dei suoi colori è garanzia contro lo scolorimento della superficie, che rimane sempre lucida.

Opalite's characteristics are its values: this material is completely eco-friendly and reusable, but, above all, it cannot be attacked by mildew and bacteria because it is non-porous. Its compactness and its extreme resistance make it suitable to withstand stress from foreseeable use, from scratches to hits. The chemical stability of its colour avoids the surface from fading, thus maintaining its shining as the time passes.

Les caractéristiques d'Opalite sont les valeurs qui en motivent le choix : le matériau est entièrement écologique et recyclable, mais surtout résistant à la moisissure et aux bactéries en raison de l'absence de porosité. Sa nature compacte et sa résistance absolue le rendent adapté aux contraintes d'exploitation, y compris aux rayures et aux chocs. La stabilité chimique de ses composants est une garantie contre la décoloration de la surface, qui reste toujours brillante.

Der Wert, der die Eigenschaften des Opalite ausmacht, motivieren zu dessen Wahl: Das Material ist vollkommen ökologisch und recycelbar und durch seine glatte Oberfläche besonders resistent gegen Schimmel und Bakterien. Seine Kompaktheit und die absolute Beständigkeit machen es strapazierfähig und resistent gegen Kratzer und Stöße. Die chemische Stabilität seiner Farben ist eine Garantie gegen Verfärbungen der Oberfläche, die immer glänzend bleibt.



Libertà espressiva senza limiti. L'Opalite, materiale termoformato, profilato e molato nei nostri reparti, diventa un lavabo sovrappiano o sottopiano di carattere e capace di andare oltre le mode. In bianco o nero. L'Opalite offre linee pulite e volumi secondo necessità nella formula del lavabo integrato. La funzionalità si unisce alla razionalità, l'emozione allo stile. In bianco o nero.

Expressive freedom without limits. Opalite, a plastic material, after being outlined and grinded in our production department, becomes an over level or under level wash-basin of great character that goes beyond fashion. Available in white or black. Interpretation of the contemporary taste. Opalite offers smooth lines and modular volumes according to its basin tops. Functionality is combined with rationality, emotions with style. Available in white or black.

Liberté d'expression sans limites. L'Opalite, matériau thermoformé, profilé et meulé dans nos ateliers, devient une vasque de caractère au design intemporel. L'Opalite offre des lignes épurées et des volumes répondant aux besoins dans la formule de la vasque moulée. La fonctionnalité est combinée à la rationalité, l'émotion au style. En blanc ou noir.

Ausdruck grenzenloser Freiheit. Opalite, ein thermoformiertes Material, in unserem Werk geformt und geschliffen, wird zu einem zeitlosen Einbau- und Unterbaubecken. In reinem Weiß oder Schwarz. Integrierte Waschbecken aus Opalite haben klare Linien und das richtige Volumen. Funktionalität vereint sich mit Rationalität, Emotion und Stil. In reinem Weiß oder Schwarz.





## I nostri lavabi in Opalite

Durante un ciclo termico di oltre sei ore, il vetro in pasta con aggiunta di fluoro, scaldato a 500°C, da solido diventa plastico fino ad assumere le forme e le dimensioni richieste. Tale affascinante trasformazione avviene nei nostri forni a carosello e sotto l'attento controllo di telecamere a infrarossi. È, poi, l'esperienza dei nostri vetrai a consentire di "detensionare" la materia in modo da ottenere lavabi integrati, in appoggio, sovrappiano o sottopiano, veri protagonisti della stanza da bagno.

### Our Opalite wash-basins

During a thermal cycle of more than six hours, our Opalite is heated till it reaches 500°C, and it becomes plastic enough to be shaped in the needed dimensions. This fascinating transformation takes place in our special ovens under the careful monitoring of our infrared cameras. Then, our skilled glassworkers are able to "de-stress" this material for obtaining basin tops or over lever and under level wash-basins which play a key role in bathroom furnishing.

### Nos vasques en Opalite

Au cours d'un cycle thermique de plus de six heures, la pâte de verre avec addition de fluor, est chauffée à 500°C, et passe de l'état solide à l'état semi-liquide pour prendre les formes et les dimensions requises. Cette transformation fascinante se produit dans nos fours et sous le contrôle étroit de caméras infrarouges. Le plateau est alors détensionné grâce à l'expertise de nos maîtres verriers pour obtenir des vasques intégrées, à poser, semi-encastrées ou sous plan, véritables protagonistes de la salle de bains.

### Unsere Waschbecken in Opalite

Während eines thermischen Zyklus von mehr als sechs Stunden wird die solide Opalite-Platte bei 500°C erhitzt und nahezu plastisch, sodass nach und nach die gewünschte Form und Abmessung erreicht werden. Diese faszinierende Transformation geschieht in unseren Spezialöfen, die mittels Infrarotkameras ständig kontrolliert werden. Dazu kommt die Erfahrung unserer Glaser die Spannung aus dem Glas zu nehmen, um so integrierte Waschbecken, Aufsatz- Einbau- oder Unterbaubecken zu fertigen, die zu wahren Protagonisten des Badezimmers werden.



# dualite®

**dualite®** è innanzitutto un'idea, un'intuizione, una sfida. Ci siamo posti l'obiettivo di incollare sotto vuoto due vetri retrocolorati da 4 mm per ottenerne un monolite da 8 mm. La solida cultura aziendale e uno spiccato amore per il bello ci hanno permesso di trasformare tale progetto in una collezione, oggi a marchio registrato Artelinea.

La rivoluzionaria finitura monolitica serba in sé il concetto di cristallo stratificato di sicurezza. Il foglio adesivo posizionato tra i due vetri, sottoposti alla pressione della pompa del vuoto alla temperatura di 100°C, produce un esclusivo corpo unico con resistenza e potenzialità tecniche raddoppiate.



**dualite®** is, first of all, an idea, a challenge. We aimed at pasting two 4mm rear coloured sheets of glass together with a process of vacuum-sealing in order to obtain a single element in 8mm thickness. A strong company culture and a strong passion for beauty have allowed us to transform this project in a collection that today is a registered trademark. This revolutionary single finish retains the concept of safety crystal. The adhesive sheet used between the two sheets of glass, under the pressure of the vacuum pump and a temperature of 100°C, create an exclusive single element with doubled resistance and technical potentialities of the glass.

**dualite®** est d'abord et avant tout une idée, une intuition, un défi. Nous nous sommes fixé pour objectif de coller sous vide deux verres rétrocolorés de 4 mm d'épaisseur pour obtenir un monolithe de 8 mm. La forte culture d'entreprise et l'amour immodéré de la beauté nous ont permis de transformer ce projet en une collection, au nom déposé par Artelinea. La finition monolithique révolutionnaire porte en elle le concept de verre feuilleté. La feuille adhésive placée entre les deux plaques de verre, soumises à la pression de la pompe à vide à une température de 100°C, produit un élément unique et exclusif avec une résistance et un potentiel technique deux fois plus élevés.

**dualite®** ist in erster Linie eine Idee, eine Intuition, eine Herausforderung. Unser Ziel war es, zwei rückseitig gefärbte, 4 mm dicke, Glasscheiben im Vakuum zusammenzukleben, um einen Monoblock von 8 mm Dicke zu erhalten. Durch eine starke Unternehmenskultur und die ausgeprägte Liebe für alles Schöne konnten wir dieses Projekt in eine Kollektion mit dem eingetragenen Warenzeichen Artelinea umsetzen. Die revolutionäre Feinbearbeitung ist eigentlich das Konzept des Verbundglases. Die Klebefolie wird zwischen den beiden Glasscheiben mittels einer Vakuumpumpe angeordnet und einer Temperatur von 100 °C Vakuum ausgesetzt. So entsteht ein einzigartiges Objekt, dessen Widerstandsfähigkeit und technisches Potential verdoppelt wird.

## dualite®

### Ricevuta di presentazione per Marchio d'impresa.

Domanda numero:  
302016000036239

### Receipt for the presentation of a trademark.

Request no.:  
302016000036239

### Accusé de réception de dépôt de nom.

Demande n.:  
302016000036239

### Nachweis des präsentierten Geschäftszeichens.

Anfrage Nummer:  
302016000036239



Lo straordinario potenziale creativo e stilistico di **dualite®** è racchiuso nella possibilità di scegliere i colori da abbinare e il tipo di finitura dei due vetri. Il cristallo contiene, infatti, due anime di colore diverso: lucido + lucido, lucido + silk, silk + lucido, silk + silk. Ogni personalizzazione è garanzia di un monolite dalla fortissima identità.

The extraordinary creative and stylistic potential of **dualite®** is the possibility of choosing the colour matching and the type of finish (gloss or silk) of the two sheets of glass. This glass has two different coloured souls: gloss + gloss glass, gloss + silk glass, silk + gloss glass, silk + silk glass. Each choice guarantees a single element with a strong identity.

L'extraordinaire potentiel créatif et stylistique de **dualite®** réside dans la possibilité de choisir les couleurs à marier et le type de finition des deux verres. Dualite contient, en effet, deux corps de couleurs différentes : brillant + brillant, brillant + silk, silk + brillant, silk + silk. Chaque personnalisation est une garantie d'un monolithe à l'identité très forte.

Das außergewöhnliche kreative und stilistische Potential von **dualite®** liegt darin, dass Farben und Feinbearbeitung der Gläser ausgewählt werden können. Das Kristall enthält in der Tat zwei verschiedenfarbige Erscheinungsbilder: glänzend + glänzend, glänzend + Seide, Seide + glänzend, Seide + Seide. Jede individuelle Kreation ist die Garantie für einen Monoblock mit sehr starker Identität.



## DESIGN

Un materiale rigoroso, testimone del saper fare. Una superficie che riflette ciò che la circonda. Linee, sinonimo di preziosità.

### Design

A rigid material which shows our company's skills. A surface that reflects its surroundings. Lines which mean preciousness.

### Design

Un matériau rigoureux, témoin du savoir-faire. Une surface qui reflète son environnement. Des lignes synonymes de préciosité.

### Design

Ein rigoroses Material und Beweis großen Know-hows. Eine Oberfläche, die ihre Umgebung widerspiegelt. Linien, ein Synonym für das Edle.

## ELEGANZA

Tecnologia e poesia si accompagnano alla libertà progettuale: il bagno è esclusivo, attuale, eterno come il vetro.

### Elegance

Technology and poetry are combined with freedom in design: the bathroom becomes exclusive, current, eternal as the glass is.

### Élégance

Technologie et poésie accompagnent la liberté de conception : la salle de bains est unique, actuelle, éternelle comme le verre.

### Eleganz

Technik und Poesie begleiten die Gestaltungsfreiheit: Das Bad ist exklusiv, aktuell, zeitlos wie das Glas.

## RESISTENZA

La compattezza e l'omogeneità strutturale rendono il vetro inalterabile e particolarmente resistente. Tali qualità con **dualite®** si moltiplicano per due.

### Resistance

The glass structural compactness and homogeneity make it unalterable and high resistant. These qualities are redoubled with **dualite®**.

### Résistance

La compacité et l'homogénéité structurelle rendent le verre inaltérable et particulièrement résistant. Avec **dualite®**, ces qualités sont multipliées.

### Widerstand

Kompaktheit und strukturelle Einheitlichkeit bilden ein unveränderbares und widerstandsfähiges Glas. Diese Qualitäten verdoppeln sich mit **dualite®**.

## COLORE UNIFORME

La nuova gamma di smalti a base acquosa risponde a un gusto ricercato e gode di una straordinaria stabilità chimica contro ogni scolorimento.

### Uniform Colour

The new range of water-based lacquers responds to a refined taste and benefits from an extraordinary chemical stability against fading.

### Couleur Uniforme

La nouvelle gamme de glaçages à base d'eau répond à un goût raffiné et jouit d'une stabilité chimique extraordinaire contre la décoloration.

### Gleichmäßige Farbe

Die neuen wasserbasierten Glasuren entsprechen einem anspruchsvollen Geschmack und sind chemisch außergewöhnlich stabil gegen Verfärbung.

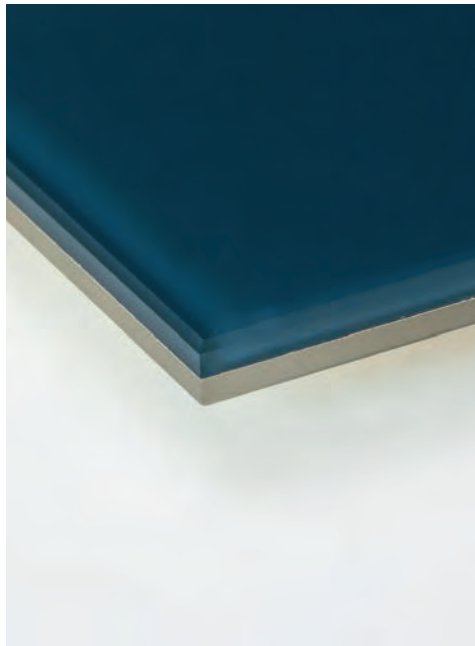

## Produzione e realizzazione interna

L'utilizzo di forni di fusione presenti nei nostri reparti, la capacità degli artigiani di piegare e termoformare con maestria il vetro, il rigoroso controllo della qualità in ogni fase della produzione, sono il primo valore aggiunto di Dualite. È necessaria, infatti, una lunga esperienza di lavorazione del vetro per ottenere un prodotto monolitico dall'incollaggio in pressione di due lastre di vetro retrocolorato. Il risultato è un rivestimento versatile e sicuro, impreziosito dal gioco di due tonalità scelte dalla cartella colori Artelinea, nelle varianti lucido o satinato.

Tra i due vetri retrocolorati, un foglio di collante specifico.  
L'incollaggio avviene nei nostri forni, sottovuoto e alla temperatura di 100°C.  
Grazie alle molatrici, i profili sono perfettamente sagomati.

A sheet of a special sealing is inserted between the two rear coloured pieces of glass.  
Pasting is carried out in our ovens, with vacuum sealing technology at a temperature of 100°C.  
Thanks to our grinding machines, profiles are perfectly shaped.

Entre les deux verres rétrocolorés, une feuille de colle est appliquée.  
L'encollage a lieu dans nos fours, sous vide et à une température de 100°C  
Grâce aux meuleuses, les bords sont parfaitement découpés.

Eine spezielle Klebefolie zwischen den beiden rückseitig gefärbten Glasplatten. Die Verklebung erfolgt in unseren Öfen im Vakuum und bei einer Temperatur von 100° C.  
Dank der Schleifmaschinen werden die Seitenprofile perfekt geformt.



## Internal industrial production

The usage of the melting ovens in our company departments, the skills of our artisans in bending and thermoforming the glass with mastery, and the strict quality monitoring for each production stage are the first added value of Dualite. A long experience in glass manufacturing is in fact necessary for being able to paste two sheets of rear coloured glass with a process of vacuum sealing. The result is a versatile and safe covering, embellished by the use of two different shades the customer that can be chosen from the Artelinea sample book, both in gloss and silk finish.

## Production et réalisation interne

L'utilisation de fours de fusion présents dans nos locaux, la capacité des artisans à plier et à thermoformer magistralement le verre, le contrôle strict de la qualité à tous les stades de la production, sont la première valeur ajoutée de Dualite. Il faut, en fait, une longue expérience du travail du verre pour obtenir un produit monolithique par collage en pression de deux feuilles de verre rétrocoloré. Le résultat est un revêtement polyvalent et sûr, enrichi par le jeu de deux teintes choisies dans le nuancier Artelinea, dans des variantes brillantes ou satinées.

## Interne Produktion und Realisierung

Die Verwendung von Schmelzöfen in unseren Abteilungen, die Fähigkeit der Handwerker, das Glas zu biegen und thermoformieren und die strenge Qualitätskontrolle in jeder Produktionsphase sind der erste Mehrwert des Dualite. Man braucht tatsächlich eine lange Erfahrung in der Glasverarbeitung, um aus zwei rückseitig gefärbten Gläsern im Druckklebeverfahren ein monolithisches Produkt herzustellen. Das Ergebnis ist eine vielseitige und sichere Beschichtung, die durch das Farbenspiel aus zwei Tönen der Farbpalette von Artelinea, glänzend oder satiniert, noch aufgewertet wird.





La scelta compositiva è ampia. Grazie alle diverse profondità dei mobili, possiamo soddisfare ogni esigenza di gestione dello spazio. Le aperture possono variare tra cassetti, cestoni o vani a giorno. La progettazione di monoblocchi con basintop, portalavabi, consolle o strutture di legno è personalizzabile e flessibile. La lamiera, l'acciaio inox, il melaminico, in abbinamento al legno, così come il rivestimento in cristallo smaltato con decorazione laser, ampliano il numero di soluzioni proposte.

### Our vanity units

A wide modularity is available for our vanity units. Thanks to their different depths we can meet any customer's need. Our vanity units can have two drawers, one deep drawers or one drawer and an open compartment. Our base units, basin units or hanging basin units are customizable. The stainless steel, the hydro repellent lacquered melamine wood structures, along with enameled crystal covering with laser decoration, enlarge the number of possible solutions.

### Nos meubles

Le choix des compositions est large. Grâce aux différentes profondeurs des meubles, nous pouvons répondre à tous les besoins de gestion de l'espace. Les typologies de meubles comprennent les tiroirs, les caissons ou les compartiments ouverts. La conception de Monoblocs avec basintop, meubles sous vasques, consoles ou structures en bois est personnalisable et modulable. L'acier inoxydable, le MDF, alliés au bois, ainsi que les revêtement en verre émaillé avec décoration au laser, élargissent l'éventail de solutions proposées.

### Unsere Möbel

Die kompositorische Auswahl ist groß. Aufgrund der unterschiedlichen Möbeltiefen können wir alle Anforderungen bezüglich der Raumgröße erfüllen. Die Öffnungen können zwischen kleinen und großen Schubladen oder Fächern variieren. Die Gestaltung von Monoblocken mit Basintop, Unterschrank, Konsolen oder Holzstrukturen ist anpassbar und flexibel. Edelstahl, Melamin, in Kombination mit Holz sowie die Beschichtung aus emailiertem Kristall mit Laserdekoratation, erweitern das Angebot an vorgeschlagenen Lösungen.



## Artelinea Collections

### Maestri falegnami

Nessun dettaglio è lasciato al caso. I mobili sono prodotti interamente nel nostro reparto di falegnameria con innovative macchine in grado di effettuare foratura ed equilibratura. Selezioniamo i materiali e le finiture per un arredo bagno di design, esclusivo e durevole nel tempo.

### Skilled carpenters

Details are not left to chance. Our vanity units are completely manufactured in our carpentry department with innovative machinery. We select materials and finishes for an exclusive, fashion and lasting bathroom furnishing.

### Menuisiers

Aucun détail n'a été laissé au hasard. Le mobilier est entièrement fabriqué dans nos ateliers de menuiserie avec des machines innovantes assurant le perçage et la mise en équerre. Nous sélectionnons les matériaux et les finitions pour un meuble de salle de bains au design, exclusif et durable.

### Tischlermeister

Kein Detail wird dem Zufall überlassen. Die Möbel werden vollständig in unserer hauseigenen Tischlerei mit Maschinen der Avantgarde hergestellt, die jede Art von Bohrungen und Äquilibrierungen ausführen können. Für die Designer-Bad Möbel wählen wir exklusive und langlebige Materialien.



## Rivestimento interamente sostituibile

Nel nostro reparto di assemblaggio, applichiamo le lastre di vetro sulla struttura del mobile in alluminio, per mezzo di un sistema che consente la sostituzione dei rivestimenti. In qualsiasi momento, è possibile rinnovare l'arredo bagno o scegliere un altro colore del mobile.



### Completely replaceable covering

In our assembly department, the glass covering is attached on an aluminum plate and then screwed to the hydro repellent lacquered melamine wood structure of the vanity unit. In each moment the glass covering of our units can be replaced for updating bathroom furnishing or simply renewing its colour.

### Revêtements entièrement remplaçables

Dans notre service d'assemblage, nous appliquons les revêtements en verre à des supports en aluminium eux-même vissés sur la structure du meuble. Ce système permet le remplacement de toutes les plaques. A tout moment, vous pouvez renouveler votre salle de bain ou choisir une autre couleur de mobilier.

### Vollständig austauschbare Verkleidung

In unserer Montageabteilung bringen wir die Glasscheiben auf die Struktur der Möbel in Aluminium mit einem System an, das den Austausch der Teile möglich macht. Die Badezimmereinrichtung kann zu jeder Zeit erneuert oder die Farbe der Möbel geändert werden.

Frontale cassetto



Drawer front  
Façade tiroir  
Front-Abdeckung

Interno cassetto con  
contenitore optional

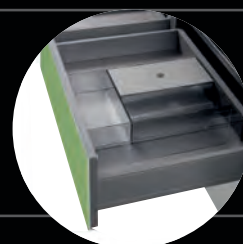

Interior drawer with  
optional container  
Intérieur du tiroir avec élément  
de rangement en option  
Interne Schublade mit  
optionalem Behältnis ohne  
Boden, als Zubehör

Particolari interni  
cassetti grigio scuro

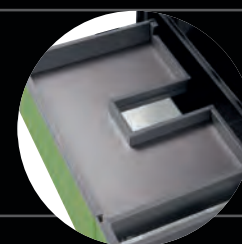

Details of the interior drawer  
in dark grey  
Détails intérieurs  
de tiroirs gris foncé  
Detailansicht der dunkelgrauen  
Innenseite der Schublade



I cassetti e i cestoni sono divisi in scomparti di diverse misure per riporre in ordine gli oggetti e meglio organizzare lo spazio a disposizione. È possibile un'estrazione totale perché i cassetti scorrono su guide sicure e resistenti. I mobili si aprono con un semplice tocco e si chiudono in modo dolce e silenzioso. La scorrevolezza garantita e il massimo comfort di utilizzo permangono anche in caso di cassetti e cestoni pesanti, per tutta la vita del mobile.



**Equipment for interior drawers. Functional design**

Drawers and deep drawers of our vanity units can be internally divided in compartments of different sizes for tidying up and organizing room inside the drawer. A total extraction of the drawers is possible thanks to secure and resistant runners. Our drawers can be opened easily and closed silently. The ease of movement of our drawers and the comfort in their usage are not affected by heavy drawers or deep drawers, for all the vanity unit life.

**Les accessoires intérieurs. Design fonctionnel**

Les caissons et les tiroirs sont divisés en compartiments de différentes tailles pour ranger les objets et de organiser au mieux l'espace disponible. Une extraction totale est possible car les tiroirs glissent sur des coulissants sûrs et résistants. Les meubles s'ouvrent par un simple toucher et se referment silencieusement et sans effort. La fluidité de fermeture et un maximum de confort d'utilisation sont également présents, même en cas de tiroirs et de caissons lourds, pendant toute la durée de vie du mobilier.

**Verkleidung Internes Zubehör. Funktionales Design**

Kleine und große Schubladen sind in Fächer unterschiedlicher Größen unterteilt, um Ordnung zu halten und den verfügbaren Raum bestmöglich zu organisieren. Die Schubladen können ganz herausgezogen werden, da deren Schienen sicher und resistent sind. Die Möbel öffnen sich durch leichtes Antippen und schließen sanft und leise. Leichtgängigkeit und der absolute Bedienkomfort gelten auch für schwere Schubladen und Kommoden, für die gesamte Lebensdauer der Möbel.

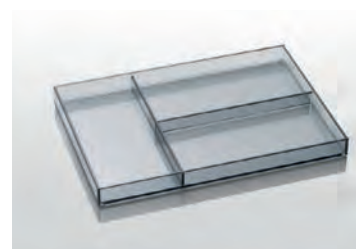
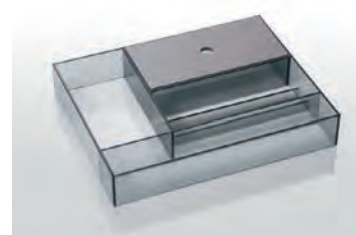

22 rosso  
92 rosso silk

23 melograno  
64 melograno silk

29 carota  
65 carota silk

38 limone  
66 limone silk

41 noce  
67 noce silk

16 terra  
94 terra silk

43 moka  
76 moka silk

45 avana  
05 avana silk

33 tortora  
53 tortora silk

49 sabbia  
79 sabbia silk

30 bianco assoluto  
70 bianco silk

60 seppia  
93 seppia silk

11 fumo  
47 fumo silk

54 grigio  
07 grigio silk

50 argento  
83 argento silk

39 notte  
99 notte silk

62 oceano  
00 oceano silk

26 sardinia  
59 sardinia silk

63 erba  
44 erba silk

15 glicine  
89 glicine silk

35 cipria  
86 cipria silk



Copyright © 2017 ARTELINEA SpA

ARTELINEA SpA si riserva il diritto di variare, senza alcun preavviso, quanto descritto e fotografato in questo catalogo.

**Tutti i diritti riservati.**

Questa pubblicazione, o parte di essa, non può essere riprodotta senza l'autorizzazione scritta di ARTELINEA SpA.

I pigmenti colorati, così come quelli neutri o trasparenti, reagiscono ai flash, variando l'aspetto cromatico; per questo motivo, gli oggetti pubblicati in questo catalogo, possono presentare lievi differenze cromatiche rispetto alla realtà.

ARTELINEA SpA reserves it self the right to vary, without any warning, the products described and photographed in this catalogue.

**All rights reserved.**

The publication cannot be reproduced in any part, in any case without the written authorization of ARTELINEA SpA.

The coloured pigments, as well as the neutral and transparent ones, react to the photographic flash, thus varying their chromatic aspect. For this reason the tones of the objects shown in this catalogue may appear slightly different in reality.

concept **anita brotto**  
photo & stylist **link**  
texts **ferena lenzi**  
printing **grafiche antiga spa**

