



CIPRIANI
SCAMBIATORI
España

TARIFA 2022



CIPRIANI SCAMBIATORI ESPAÑA S.L.

Tel. Contacto 93.432.38.59

cipriani@cipriani.es

REFERENCIA	Nº PLACAS	LONGITUD (mm)	P.V.P. INOX (€)	P.V.P. TITANIO (€)
S020-05	5	178	483,00	642,00
S020-07	7	178	527,00	725,00
S020-09	9	178	564,00	800,00
S020-11	11	178	606,00	883,00
S020-13	13	178	639,00	953,00
S020-15	15	178	673,00	1.024,00
S020-17	17	178	706,00	1.094,00
S020-19	19	178	739,00	1.165,00
S020-21	21	178	803,00	1.284,00
S020-23	23	178	840,00	1.360,00
S020-25	25	178	875,00	1.434,00
S020-27	27	178	909,00	1.507,00
S020-29	29	178	944,00	1.581,00
S020-31	31	278	1.037,00	1.685,00
S020-33	33	278	1.047,00	1.716,00
S020-35	35	278	1.082,00	1.788,00
S020-37	37	278	1.118,00	1.861,00
S020-39	39	278	1.154,00	1.934,00
S020-41	41	278	1.189,00	2.006,00
S020-43	43	278	1.225,00	2.079,00
S020-45	45	278	1.284,00	2.191,00
S020-47	47	278	1.320,00	2.265,00
S020-49	49	278	1.366,00	2.355,00
S020-51	51	478	1.459,00	2.437,00
S020-53	53	478	1.496,00	2.510,00
S020-55	55	478	1.532,00	2.584,00
S020-57	57	478	1.569,00	2.657,00
S020-59	59	478	1.606,00	2.730,00
S020-61	61	478	1.642,00	2.803,00
S020-63	63	478	1.679,00	2.876,00
S020-65	65	478	1.715,00	2.949,00
S020-67	67	478	1.752,00	3.022,00
S020-69	69	478	1.788,00	3.095,00
S020-71	71	478	1.825,00	3.168,00
S020-73	73	478	1.861,00	3.241,00
S020-75	75	478	1.898,00	3.315,00

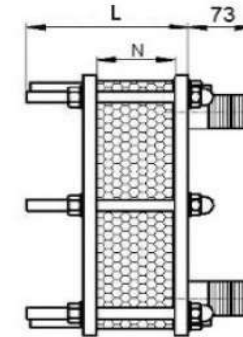
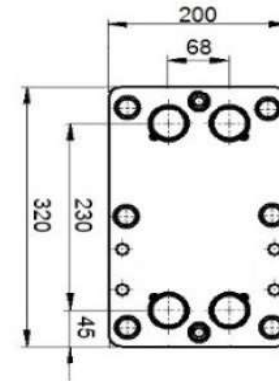

OPCIONALES

AISLAMIENTO FRÍO/CALOR

REFERENCIA	Nº MAX. PLACAS	P.V.P. (€)
AS-020-29	29	187,00
AS-020-49	49	224,00
AS-020-75	75	247,00

ANCLAJES

REFERENCIA	P.V.P. (€)
ANCLAJE SUELO	66,00
ANCLAJE PARED*	106,00

* Hasta 29 placas



CIPRIANI SCAMBIATORI ESPAÑA S.L.

Tel. Contacto 93.432.38.59

cipriani@cipriani.es

REFERENCIA	Nº PLACAS	LONGITUD (mm)	P.V.P. INOX (€)	P.V.P. TITANIO (€)
S040-05	5	178	595,00	761,00
S040-07	7	178	657,00	871,00
S040-09	9	178	725,00	991,00
S040-11	11	178	788,00	1.107,00
S040-13	13	178	834,00	1.197,00
S040-15	15	178	879,00	1.287,00
S040-17	17	178	924,00	1.377,00
S040-19	19	178	969,00	1.468,00
S040-21	21	178	1.124,00	1.708,00
S040-23	23	178	1.174,00	1.828,00
S040-25	25	178	1.224,00	1.928,00
S040-27	27	178	1.274,00	2.028,00
S040-29	29	178	1.324,00	2.128,00
S040-31	31	278	1.440,00	2.246,00
S040-33	33	278	1.501,00	2.362,00
S040-35	35	278	1.554,00	2.468,00
S040-37	37	278	1.606,00	2.565,00
S040-39	39	278	1.659,00	2.666,00
S040-41	41	278	1.711,00	2.767,00
S040-43	43	278	1.764,00	2.868,00
S040-45	45	278	1.886,00	3.083,00
S040-47	47	278	1.940,00	3.188,00
S040-49	49	278	2.019,00	3.334,00
S040-51	51	478	2.143,00	3.441,00
S040-53	53	478	2.199,00	3.545,00
S040-55	55	478	2.254,00	3.649,00
S040-57	57	478	2.309,00	3.745,00
S040-59	59	478	2.364,00	3.858,00
S040-61	61	478	2.419,00	3.963,00
S040-63	63	478	2.474,00	4.067,00
S040-65	65	478	2.529,00	4.172,00
S040-67	67	478	2.584,00	4.276,00
S040-69	69	478	2.639,00	4.381,00
S040-71	71	478	2.695,00	4.485,00
S040-73	73	478	2.750,00	4.589,00
S040-75	75	478	2.805,00	4.694,00

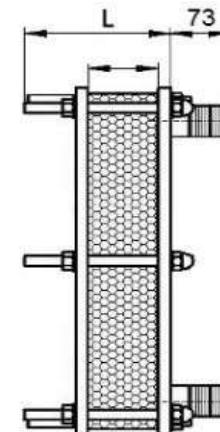
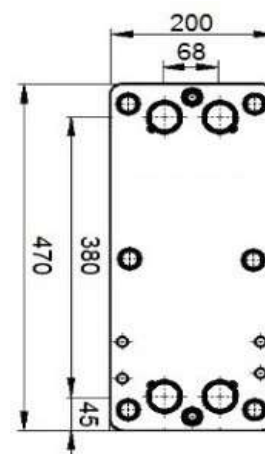

OPCIONALES

AISLAMIENTO FRÍO/CALOR

REFERENCIA	Nº MAX. PLACAS	P.V.P. (€)
AS-040-29	29	202,00
AS-040-49	49	229,00
AS-040-75	75	253,00

ANCLAJES

REFERENCIA	P.V.P. (€)
ANCLAJE SUELO	66,00
ANCLAJE PARED*	106,00

* Hasta 29 placas



CIPRIANI SCAMBIATORI ESPAÑA S.L.

Tel. Contacto 93.432.38.59

cipriani@cipriani.es

REFERENCIA	Nº PLACAS	LONGITUD (mm)	P.V.P. INOX (€)	P.V.P. TITANIO (€)
S080-05	5	178	814,00	1.013,00
S080-07	7	178	899,00	1.165,00
S080-09	9	178	984,00	1.317,00
S080-11	11	178	1.069,00	1.477,00
S080-13	13	178	1.129,00	1.600,00
S080-15	15	178	1.189,00	1.724,00
S080-17	17	178	1.249,00	1.847,00
S080-19	19	178	1.309,00	1.971,00
S080-21	21	178	1.484,00	2.271,00
S080-23	23	178	1.569,00	2.434,00
S080-25	25	178	1.634,00	2.570,00
S080-27	27	178	1.700,00	2.706,00
S080-29	29	178	1.766,00	2.841,00
S080-31	31	278	1.912,00	2.990,00
S080-33	33	278	1.995,00	3.148,00
S080-35	35	278	2.064,00	3.285,00
S080-37	37	278	2.132,00	3.421,00
S080-39	39	278	2.201,00	3.558,00
S080-41	41	278	2.270,00	3.695,00
S080-43	43	278	2.339,00	3.831,00
S080-45	45	278	2.491,00	4.105,00
S080-47	47	278	2.562,00	4.246,00
S080-49	49	278	2.657,00	4.427,00
S080-51	51	478	2.803,00	4.554,00
S080-53	53	478	2.989,00	4.880,00
S080-55	55	478	3.064,00	5.025,00
S080-57	57	478	3.139,00	5.171,00
S080-59	59	478	3.213,00	5.317,00
S080-61	61	478	3.316,00	5.508,00
S080-63	63	478	3.391,00	5.655,00
S080-65	65	478	3.467,00	5.802,00
S080-67	67	478	3.542,00	5.949,00
S080-69	69	478	3.618,00	6.096,00
S080-71	71	478	3.724,00	6.295,00
S080-73	73	478	3.800,00	6.443,00
S080-75	75	478	3.884,00	6.605,00

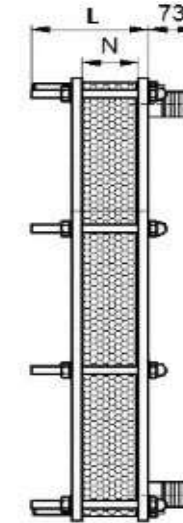
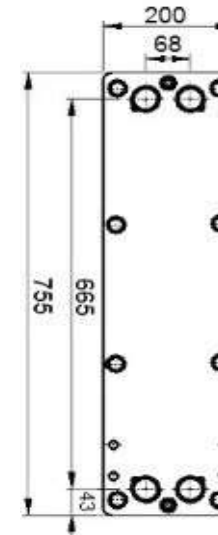

OPCIONALES

AISLAMIENTO FRÍO/CALOR

REFERENCIA	Nº MAX. PLACAS	P.V.P. (€)
AS-080-29	29	227,00
AS-080-49	49	237,00
AS-080-75	75	256,00

ANCLAJES

REFERENCIA	P.V.P. (€)
ANCLAJE SUELO	66,00
ANCLAJE PARED*	106,00

* Hasta 29 palcas



CIPRIANI SCAMBIATORI ESPAÑA S.L.

Tel. Contacto 93.432.38.59

cipriani@cipriani.es

REFERENCIA	Nº PLACAS	LONGITUD (mm)	P.V.P. INOX (€)	P.V.P. TITANIO (€)
S070-05	5	320	1.288,00	1.392,00
S070-07	7	320	1.375,00	1.540,00
S070-09	9	320	1.440,00	1.665,00
S070-11	11	320	1.523,00	1.813,00
S070-13	13	320	1.576,00	1.927,00
S070-15	15	320	1.630,00	2.040,00
S070-17	17	320	1.684,00	2.154,00
S070-19	19	320	1.738,00	2.326,00
S070-21	21	320	2.021,00	2.585,00
S070-23	23	320	2.097,00	2.836,00
S070-25	25	320	2.159,00	2.965,00
S070-27	27	320	2.220,00	3.095,00
S070-29	29	320	2.281,00	3.224,00
S070-31	31	320	2.342,00	3.353,00
S070-33	33	320	2.481,00	3.596,00
S070-35	35	320	2.544,00	3.729,00
S070-37	37	320	2.607,00	3.863,00
S070-39	39	320	2.670,00	3.996,00
S070-41	41	320	2.733,00	4.079,00
S070-43	43	460	2.751,00	4.162,00
S070-45	45	460	2.774,00	4.245,00
S070-47	47	460	1.795,00	4.328,00
S070-49	49	460	2.822,00	4.411,00
S070-51	51	460	2.881,00	4.499,00
S070-53	53	460	2.939,00	4.623,00
S070-55	55	460	2.998,00	4.747,00
S070-57	57	460	3.057,00	4.871,00
S070-59	59	460	3.115,00	4.995,00
S070-61	61	460	3.174,00	5.119,00
S070-63	63	460	3.233,00	5.243,00
S070-65	65	460	3.291,00	5.368,00
S070-67	67	460	3.350,00	5.492,00
S070-69	69	460	3.408,00	5.616,00
S070-71	71	460	3.467,00	5.740,00
S070-73	73	600	3.575,00	5.907,00
S070-75	75	600	3.880,00	6.031,00

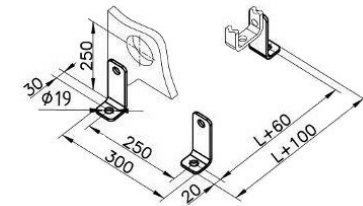
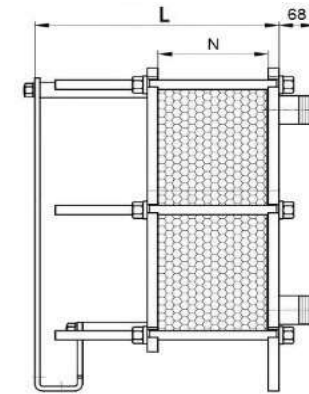
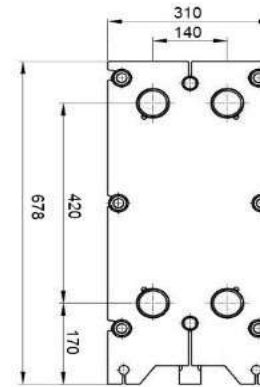

OPCIONALES

AISLAMIENTO FRÍO/CALOR

REFERENCIA	Nº MAX. PLACAS	P.V.P. (€)
AS-070-41	41	297,00
AS-070-71	71	385,00
AS-070-101	101	465,00

ANCLAJES

REFERENCIA	P.V.P. (€)
ANCLAJE SUELO	40,00



CIPRIANI SCAMBIATORI ESPAÑA S.L.

Tel. Contacto 93.432.38.59

cipriani@cipriani.es

REFERENCIA	Nº PLACAS	LONGITUD (mm)	P.V.P. INOX (€)	P.V.P. TITANIO (€)
S160-05	5	320	1.731,00	1.883,00
S160-07	7	320	1.851,00	2.104,00
S160-09	9	320	1.941,00	2.294,00
S160-11	11	320	2.056,00	2.516,00
S160-13	13	320	2.131,00	2.691,00
S160-15	15	320	2.206,00	2.866,00
S160-17	17	320	2.282,00	3.041,00
S160-19	19	320	2.357,00	3.216,00
S160-21	21	320	2.744,00	3.752,00
S160-23	23	320	2.850,00	4.053,00
S160-25	25	320	2.936,00	4.252,00
S160-27	27	320	3.022,00	4.451,00
S160-29	29	320	3.107,00	4.650,00
S160-31	31	320	3.273,00	4.971,00
S160-33	33	320	3.385,00	5.213,00
S160-35	35	320	3.474,00	5.418,00
S160-37	37	320	3.562,00	5.624,00
S160-39	39	320	3.650,00	5.829,00
S160-41	41	320	3.678,00	5.846,00
S160-43	43	460	3.694,00	6.035,00
S160-45	45	460	3.740,00	6.063,00
S160-47	47	460	3.834,00	6.228,00
S160-49	49	460	3.947,00	6.419,00
S160-51	51	460	4.031,00	6.610,00
S160-53	53	460	4.115,00	6.801,00
S160-55	55	460	4.200,00	6.992,00
S160-57	57	460	4.295,00	7.183,00
S160-59	59	460	4.362,00	7.374,00
S160-61	61	460	4.379,00	7.565,00
S160-63	63	460	4.443,00	7.756,00
S160-65	65	460	4.538,00	7.947,00
S160-67	67	460	4.620,00	8.138,00
S160-69	69	460	4.703,00	8.329,00
S160-71	71	460	4.848,00	8.520,00
S160-73	73	600	5.309,00	8.760,00
S160-75	75	600	5.398,00	8.951,00

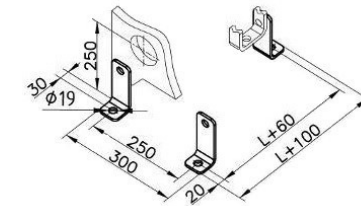
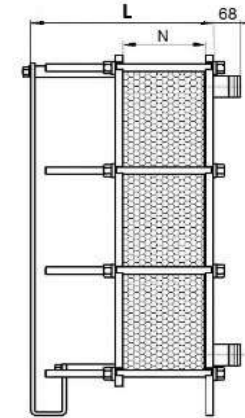
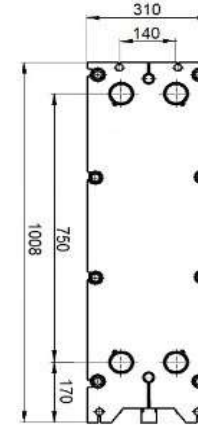

OPCIONALES

ASLAMIENTO FRÍO/CALOR

REFERENCIA	Nº MAX. PLACAS	P.V.P. (€)
AS-160-41	41	470,00
AS-160-71	71	493,00
AS-160-101	101	560,00

ANCLAJES

REFERENCIA	P.V.P. (€)
ANCLAJE SUELO	40,00



CIPRIANI SCAMBIATORI ESPAÑA S.L.

Tel. Contacto 93.432.38.59

cipriani@cipriani.es

REFERENCIA	Nº PLACAS	LONGITUD (mm)	P.V.P. INOX (€)	P.V.P. TITANIO (€)
S110-05	5	355	1.604,00	1.807,00
S110-07	7	355	1.712,00	1.996,00
S110-09	9	355	1.792,00	2.155,00
S110-11	11	355	1.895,00	2.344,00
S110-13	13	355	1.962,00	2.488,00
S110-15	15	355	2.029,00	2.632,00
S110-17	17	355	2.095,00	2.777,00
S110-19	19	355	2.162,00	2.996,00
S110-21	21	355	2.515,00	3.328,00
S110-23	23	355	2.609,00	3.649,00
S110-25	25	355	2.685,00	3.813,00
S110-27	27	355	2.761,00	3.977,00
S110-29	29	355	2.837,00	4.142,00
S110-31	31	355	2.913,00	4.306,00
S110-33	33	355	3.086,00	4.616,00
S110-35	35	355	3.164,00	4.785,00
S110-37	37	355	3.243,00	4.955,00
S110-39	39	355	3.321,00	5.124,00
S110-41	41	355	3.399,00	5.229,00
S110-43	43	495	3.485,00	5.389,00
S110-45	45	495	3.513,00	5.493,00
S110-47	47	495	3.538,00	5.598,00
S110-49	49	495	3.571,00	5.702,00
S110-51	51	495	3.644,00	5.814,00
S110-53	53	495	3.716,00	5.971,00
S110-55	55	495	3.789,00	6.129,00
S110-57	57	495	3.862,00	6.286,00
S110-59	59	495	3.935,00	6.444,00
S110-61	61	495	4.007,00	6.602,00
S110-63	63	495	4.080,00	6.759,00
S110-65	65	495	4.153,00	6.917,00
S110-67	67	495	4.226,00	7.075,00
S110-69	69	495	4.298,00	7.232,00
S110-71	71	495	4.371,00	7.390,00
S110-73	73	635	4.415,00	7.659,00
S110-75	75	635	4.789,00	7.817,00

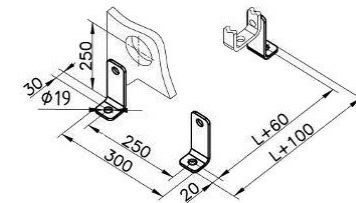
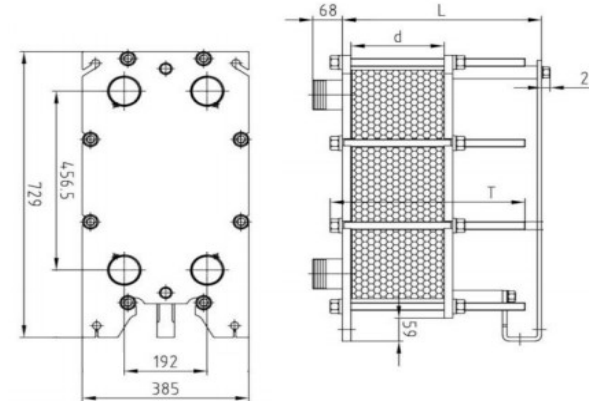

OPCIONALES

AISLAMIENTO FRÍO/CALOR

REFERENCIA	Nº MAX. PLACAS	P.V.P. (€)
AS-110-41	41	356,00
AS-110-71	71	445,00
AS-110-101	101	507,00

ANCLAJES

REFERENCIA	P.V.P. (€)
ANCLAJE SUELO	40,00



CIPRIANI SCAMBIATORI ESPAÑA S.L.

Tel. Contacto 93.432.38.59

cipriani@cipriani.es

REFERENCIA	Nº PLACAS	LONGITUD (mm)	P.V.P. INOX (€)	P.V.P. TITANIO (€)
S210-05	5	355	2.191,00	2.422,00
S210-07	7	355	2.334,00	2.679,00
S210-09	9	355	2.438,00	2.895,00
S210-11	11	355	2.574,00	3.151,00
S210-13	13	355	2.659,00	3.348,00
S210-15	15	355	2.745,00	3.544,00
S210-17	17	355	2.831,00	3.741,00
S210-19	19	355	2.917,00	4.038,00
S210-21	21	355	3.387,00	4.487,00
S210-23	23	355	3.510,00	4.923,00
S210-25	25	355	3.608,00	5.147,00
S210-27	27	355	3.705,00	5.370,00
S210-29	29	355	3.803,00	5.594,00
S210-31	31	355	3.900,00	5.817,00
S210-33	33	355	4.128,00	6.238,00
S210-35	35	355	4.229,00	6.469,00
S210-37	37	355	4.330,00	6.699,00
S210-39	39	355	4.430,00	6.930,00
S210-41	41	355	4.531,00	7.074,00
S210-43	43	495	4.629,00	7.279,00
S210-45	45	495	4.663,00	7.422,00
S210-47	47	495	4.692,00	7.564,00
S210-49	49	495	4.734,00	7.707,00
S210-51	51	495	4.827,00	7.859,00
S210-53	53	495	4.921,00	8.074,00
S210-55	55	495	5.015,00	8.289,00
S210-57	57	495	5.108,00	8.503,00
S210-59	59	495	5.202,00	8.718,00
S210-61	61	495	5.295,00	8.932,00
S210-63	63	495	5.389,00	9.147,00
S210-65	65	495	5.483,00	9.361,00
S210-67	67	495	5.576,00	9.576,00
S210-69	69	495	5.670,00	9.791,00
S210-71	71	495	5.763,00	10.005,00
S210-73	73	635	6.015,00	10.358,00
S210-75	75	635	6.523,00	10.573,00

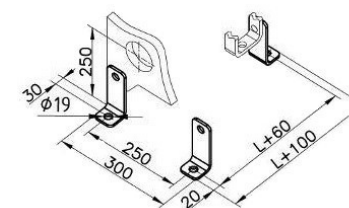
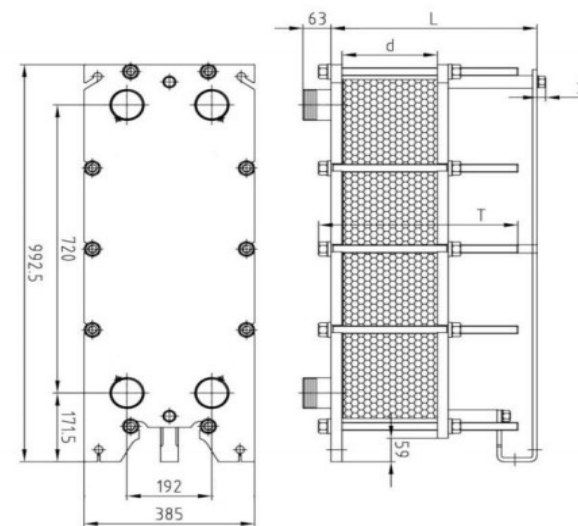

OPCIONALES

AISLAMIENTO FRÍO/CALOR			ANCLAJES	
REFERENCIA	Nº MAX. PLACAS	P.V.P. (€)	REFERENCIA	P.V.P. (€)
AS-210-41	41	495,00	ANCLAJE SUELO	40,00
AS-210-71	71	536,00		
AS-210-101	101	627,00		



CIPRIANI SCAMBIATORI ESPAÑA S.L.

Tel. Contacto 93.432.38.59

cipriani@cipriani.es

REFERENCIA	Nº PLACAS	LONGITUD (mm)	P.V.P. INOX (€)	P.V.P. TITANIO (€)
S270-05	5	385	2.697,00	2.816,00
S270-07	7	385	2.775,00	3.015,00
S270-09	9	385	2.853,00	3.214,00
S270-11	11	385	2.931,00	3.412,00
S270-13	13	385	3.009,00	3.611,00
S270-15	15	385	3.087,00	3.809,00
S270-17	17	385	3.165,00	4.008,00
S270-19	19	385	3.243,00	4.128,00
S270-21	21	385	3.321,00	4.323,00
S270-23	23	385	3.399,00	4.432,00
S270-25	25	385	3.477,00	4.623,00
S270-27	27	385	3.555,00	4.814,00
S270-29	29	385	3.633,00	5.005,00
S270-31	31	385	3.711,00	5.196,00
S270-33	33	385	3.789,00	5.388,00
S270-35	35	385	3.867,00	5.579,00
S270-37	37	385	3.945,00	5.770,00
S270-39	39	385	4.023,00	5.961,00
S270-41	41	385	4.101,00	6.152,00
S270-43	43	485	4.213,00	6.188,00
S270-45	45	485	4.291,00	6.374,00
S270-47	47	485	4.369,00	6.559,00
S270-49	49	485	4.447,00	6.745,00
S270-51	51	485	4.525,00	6.931,00
S270-53	53	485	4.603,00	7.116,00
S270-55	55	485	4.681,00	7.302,00
S270-57	57	485	4.759,00	7.487,00
S270-59	59	485	4.837,00	7.673,00
S270-61	61	485	4.915,00	7.859,00
S270-63	63	485	4.993,00	8.044,00
S270-65	65	485	5.072,00	8.230,00
S270-67	67	485	5.150,00	8.415,00
S270-69	69	485	5.228,00	8.601,00
S270-71	71	485	5.306,00	8.787,00
S270-73	73	625	5.339,00	9.015,00
S270-75	75	625	5.414,00	9.201,00

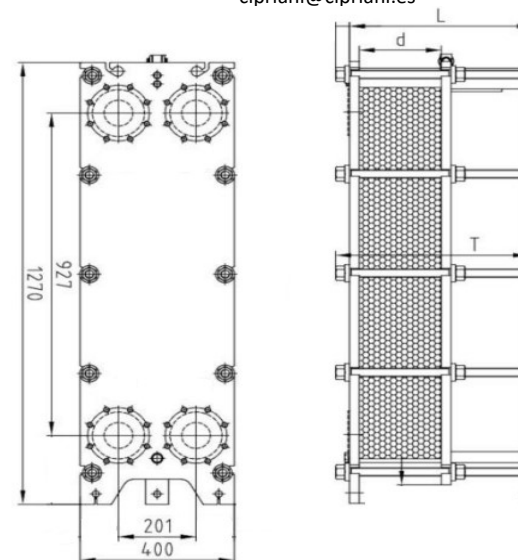

OPCIONALES

AISLAMIENTO FRÍO/CALOR

REFERENCIA	Nº MAX. PLACAS	P.V.P. (€)
AS-270-41	41	1.023,00
AS-270-71	71	1.023,00
AS-270-101	101	1.287,00

* Anclaje a suelo - Incluido



CIPRIANI SCAMBIATORI ESPAÑA S.L.

Tel. Contacto 93.432.38.59

cipriani@cipriani.es

REFERENCIA	Nº PLACAS	LONGITUD (mm)	P.V.P. INOX (€)	P.V.P. TITANIO (€)
S300-05	5	740	3.138,00	3.480,00
S300-07	7	740	3.218,00	3.749,00
S300-09	9	740	3.298,00	4.019,00
S300-11	11	740	3.378,00	4.288,00
S300-13	13	740	3.459,00	4.558,00
S300-15	15	740	3.539,00	4.827,00
S300-17	17	740	3.619,00	5.097,00
S300-19	19	740	3.699,00	5.366,00
S300-21	21	740	3.779,00	5.636,00
S300-23	23	740	3.860,00	5.905,00
S300-25	25	740	3.940,00	6.174,00
S300-27	27	740	4.020,00	6.444,00
S300-29	29	740	4.100,00	6.713,00
S300-31	31	740	4.181,00	6.983,00
S300-33	33	740	4.261,00	7.252,00
S300-35	35	740	4.341,00	7.522,00
S300-37	37	740	4.421,00	7.791,00
S300-39	39	740	4.501,00	8.061,00
S300-41	41	740	4.582,00	8.330,00
S300-43	43	740	4.662,00	8.600,00
S300-45	45	740	4.742,00	8.869,00
S300-47	47	740	4.822,00	9.139,00
S300-49	49	740	4.902,00	9.408,00
S300-51	51	740	4.983,00	9.678,00
S300-53	53	740	5.063,00	9.947,00
S300-55	55	740	5.143,00	10.216,00
S300-57	57	740	5.223,00	10.485,00
S300-59	59	740	5.303,00	10.754,00
S300-61	61	740	5.384,00	11.023,00
S300-63	63	740	5.464,00	11.292,00
S300-65	65	740	5.544,00	11.561,00
S300-67	67	740	5.624,00	11.830,00
S300-69	69	740	5.704,00	12.099,00
S300-71	71	740	5.785,00	12.368,00
S300-73	73	740	5.864,00	12.637,00
S300-75	75	740	5.945,00	12.906,00

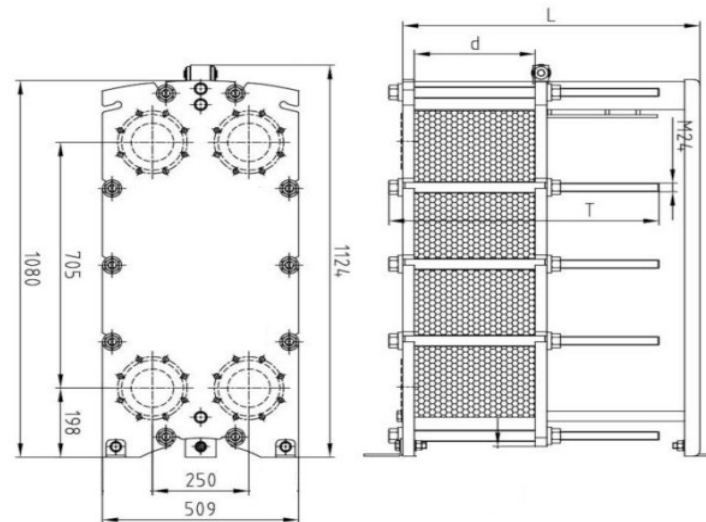

OPCIONALES

AISLAMIENTO FRÍO/CALOR

REFERENCIA	Nº MAX. PLACAS	P.V.P. (€)
AS-300-101	101	1.762,00

* Anclaje a suelo - Incluido

SOLDADOS



CIPRIANI SCAMBIATORI ESPAÑA S.L.

Tel. Contacto 93.432.38.59
cipriani@cipriani.es

SERIE 2A14					
MODELO	CONEXIONES	FONDO (mm)	PESO (kg)	P.V.P. (€)	P.V.P. AISLAMIENTO (€)
2A14-10	3/4" M	32	1,00	109,00	154,00
2A14-20	3/4" M	55	1,50	130,00	154,00
2A14-30	3/4" M	78	2,00	147,00	154,00
2A14-40	3/4" M	101	2,50	168,00	154,00

SERIE 2A22					
MODELO	CONEXIONES	FONDO (mm)	PESO (kg)	P.V.P. (€)	P.V.P. AISLAMIENTO (€)
2A22-10	3/4" M	32	1,50	122,00	162,00
2A22-20	3/4" M	55	2,20	151,00	162,00
2A22-30	3/4" M	78	2,90	180,00	162,00
2A22-40	3/4" M	101	3,70	237,00	162,00
2A22-50	3/4" M	124	4,40	300,00	162,00

SERIE 2B31					
MODELO	CONEXIONES	FONDO (mm)	PESO (kg)	P.V.P. (€)	P.V.P. AISLAMIENTO (€)
2B31-15	1-1/4" M	45	3,10	251,00	154,00
2B31-20	1-1/4" M	57	3,90	300,00	154,00
2B31-30	1-1/4" M	81	5,00	363,00	162,00
2B31-40	1-1/4" M	104	6,10	426,00	162,00
2B31-50	1-1/4" M	128	7,10	497,00	170,00
2B31-60	1-1/4" M	151	8,20	536,00	170,00

SERIE 2C110					
MODELO	CONEXIONES	FONDO (mm)	PESO (kg)	P.V.P. (€)	P.V.P. AISLAMIENTO (€)
2C110-30	2" M	84	18,90	934,00	255,00
2C110-40	2" M	108	23,40	1.080,00	255,00
2C110-50	2" M	132	28,00	1.226,00	270,00

SERIE 2C170					
MODELO	CONEXIONES	FONDO (mm)	PESO (kg)	P.V.P. (€)	P.V.P. AISLAMIENTO (€)
2C170-30	2" M	84	30,00	1.202,00	385,00
2C170-40	2" M	108	36,10	1.415,00	385,00
2C170-50	2" M	132	42,30	1.628,00	410,00

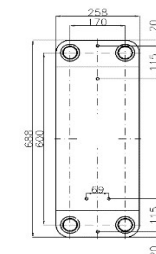
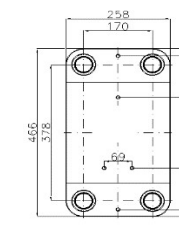
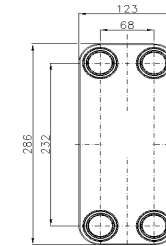
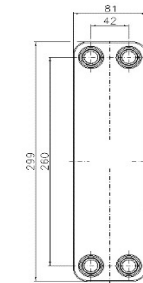
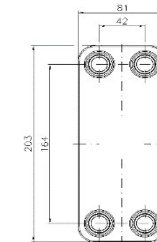

TUBULARES



CIPRIANI SCAMBIATORI ESPAÑA S.L.

Tel. Contacto 93.432.38.59

cipriani@cipriani.es

INOXIDABLE (AGUA)								
MODELO	CONEXIONES		LONGITUD L (mm)	DIÁMETRO D (mm)	ANCHO TOTAL B (mm)	ENTRE EJES B (mm)	PESO (Kg)	P.V.P. (€)
	Entrada/salida 1°	Entrada/salida 2°						
T03	1"	1-1/2"	637	102	144	451	7,3	553,00
T05	1"	2"	1.103	102	144	884	12,4	813,00
T10	2"	2"	946	140	190	598	23,5	1.354,00

TITANIO (AGUA)								
MODELO	CONEXIONES		LONGITUD L (mm)	DIÁMETRO D (mm)	ANCHO TOTAL B (mm)	ENTRE EJES B (mm)	PESO (Kg)	P.V.P. (€)
	Entrada/salida 1°	Entrada/salida 2°						
TITS03	1-1/2"	1-1/2"	353	102	140	170	2,1	892,00
TITS05	1-1/2"	1-1/2"	453	102	140	270	2,7	996,00

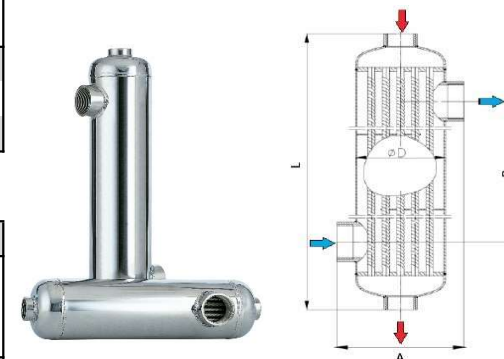

INOXIDABLE (VAPOR)											
MODELO	CONEXIONES		LONGITUD L (mm)	DIÁMETRO D (mm)	ANCHO TOTAL A (mm)	ENTRE EJES B (mm)	ENTRE EJES C (mm)	PESO (Kg)	P.V.P. (€)	P.V.P. AISLAMIENTO (€)	P.V.P. ANCLAJES (€)
	Entrada/salida 1°	Entrada/salida 2°									
TV2FF	DN40	DN40	942	80	253	853	160	14,5	2.452,00	520,00	260,00
TV3FF	DN50	DN50	1.041	102	278	917	172	21,1	3.315,00	570,00	260,00
TV5FF	DN65	DN65	1.047	140	317	908	201	30,5	4.665,00	570,00	260,00
TV6FF	DN80	DN80	1.068	159	341	907	206	37,3	5.465,00	630,00	260,00
TF9FF	DN100	DN100	1.050	219	390	886	256	52,1	7.528,00	648,00	278,00

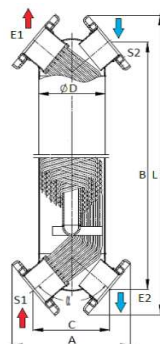

DESMONTABLES



CIPRIANI SCAMBIATORI ESPAÑA S.L.

Tel. Contacto 93.432.38.59

cipriani@cipriani.es

PROTECCIÓN PAQUETE PLACAS

PROTECCIÓN PAQUETE DE PLACAS P.V.P. (€)				
MODELO	HASTA 29 P	HASTA 49 P	HASTA 75 P	HASTA 101 P
S020+	166	184	202	-
S040+	173	195	216	-
S080+	188	202	220	262
MODELO	HASTA 41 P	HASTA 71 P	HASTA 101 P	HASTA 151 P
S070+	166	195	238	271
S160+	160	213	267	314
S110+	148	192	231	260
S210+	156	209	263	306
S270+	163	220	278	324

Protección del paquete de placas fabricada en acero inoxidable AISI304



BANDEJA DE CONDENSACIÓN

BANDEJA CONDENSACIÓN P.V.P. (€)				
MODELO	HASTA 29 P	HASTA 49 P	HASTA 75 P	HASTA 101 P
S020+	132	136	143	-
S040+	132	136	143	-
S080+	132	136	143	161
MODELO	HASTA 41 P	HASTA 71 P	HASTA 101 P	HASTA 151 P
S070+	153	163	171	179
S160+	153	163	171	179
S110+	153	167	171	183
S210+	153	167	171	183
S270+	153	167	171	183

Bandeja en Inox 304 con manguito de desagüe 3/4"



LIMPIEZA INTERCAMBIADORES

LIMPIEZA DE PLACAS POR RECIRCULACIÓN		
MODELO	APLICACIÓN	P.V.P. (€)
CIPRI DESIN 10	Limpieza ácida, contra cal, lodos y fangos. Apto para circuitos alimentarios.	49,00 (5 litros)
CIPRI NEUTREX	Neutralizador. Permite desaguar a la red los circuitos tratados con DESIN 10	27,00 (5 litros)

LIMPIEZA DE PLACAS POR RECIRCULACIÓN		
MODELO	APLICACIÓN	P.V.P. (€)
CIPRI DESENGRASANTE INOX10	Limpieza ácida contra grasas Apto para uso alimentario	38,00 (5 litros)
CIPRI INOX TITAN 10	Limpieza contra cal, lodos y fangos. Apto para Titanio	46,00 (5 litros)
CIPRI NEUTREX 10	Neutralizador. Permite desaguar a la red los circuitos tratados con INOX 10 e INOX TITAN 10	27,00 (5 litros)



ción sin dañar los diferentes materiales empleados (placas, juntas,...). Cada garrafa incluye instrucciones para su uso y aplicación