

2023

TARIFA PVP

Edición 13 de marzo

 **PP/PP3**

 **TRIPLUS**

 **SILERE**

 **PPECOFORTE**



Sistemas de tuberías para
evacuación insonorizada

 **italsan**

Indice

Sistema de tuberías y accesorios en polipropileno triple capa TRIPLUS

5 Sistema de evacuación insonorizada. Características e instalación

7 Tubería

8 Accesorios

14 Adaptadores entre distintos sistemas

Soluciones en la instalación

17 Curva 87° 30'

18 Triplus Multiconexión

19 Triplus bote sifónico inspeccionable

20 Válvula de admisión de aire

21 Collarines intumescentes

Sistema de evacuación con derivación de ventilación

22 Triplus Derivación de ventilación

Indice

Tuberías en polipropileno triple capa fonoabsorbente PP/PP3 Phono

28 Sistema en PP fonoabsorbente, la alternativa al PVC.
Características e instalación

30 Tubería

31 Accesorios

34 Adaptadores entre distintos sistemas

Sistema de tuberías y accesorios en PP monocapa con carga mineral SILERE

38 Sistema en PP con carga mineral.
Máximo confort acústico

40 Tubería

41 Accesorios

44 Adaptadores entre distintos sistemas

Botes sifónicos en polipropileno

45 Sifones y botes sifónicos PP

Sistema de Evacuación en PP-HM ECOFORTE

52 Tubería

53 Accesorios



 **TRIPLUS**



Sistema de
evacuación
insonorizada

Sistema de tuberías y accesorios de polipropileno triple capa para evacuación insonorizada

El sistema TRIPLUS se compone de la tubería y los accesorios en polipropileno copolímero triple capa, con la capa intermedia en PP reforzado con carga mineral para evacuación de aguas residuales a baja y alta temperatura.

Capa intermedia

Está realizada con una mezcla de polipropileno y cargas minerales que garantiza una elevada resistencia mecánica y unas prestaciones acústicas óptimas.

Campana y espiga de acoplamiento con junta de labio

La campana y espiga de acoplamiento lleva una junta de labio que asegura la estanqueidad hidráulica y el deslizamiento del tubo por efecto de las dilataciones térmicas. Las características geométricas de la campana garantizan una colocación fácil y rápida.



Capa exterior

Garantiza una elevada resistencia al impacto y una óptima protección mecánica.

Capa interior

El interior de la tubería está constituido por una capa de polipropileno que ofrece una superficie interior muy lisa y una alta resistencia a los agentes químicos.

Características

- Sistema de unión por junta elastomérica monolabial.
- Producto conforme según norma UNE-EN 1451-1.
- Resistencia al agua caliente según DIN 1986.
- Certificado Fraunhofer nivel de fonoabsorbencia máxima de 12 dB(A) con caudal de descarga de 2 l/s según EN 14366.

Certificados de Calidad

- Certificado de calidad AENOR según UNE EN 1451-1 obtenido en la gama de tubería y en la gama de accesorios.
- Certificado Fraunhofer Nivel Presión Sonora Lsc.A según EN 14366: 12 dB (A) con caudal de descarga 2 l/s.
- Certificado Green Building de reciclabilidad y sostenibilidad.
- Declaración ambiental de producto DAP.



Aplicaciones

- Evacuación de aguas residuales en el interior del edificio hasta 95 °C.
- Ventilación primaria, secundaria y terciaria.
- Evacuación de aguas pluviales.
- Sistemas gravitatorios industriales.
- Evacuación de condensados de circuitos de climatización.

La instalación

Sistema de unión mediante boca con junta elastomérica monolabial

El sistema **TRIPLUS** garantiza una instalación rápida y sin el uso de adhesivos, equipos eléctricos o maquinaria especial gracias al sistema de unión con junta labial.



Sistema de unión mediante manguito corredizo

El sistema **TRIPLUS** dispone del manguito corredizo, el acoplamiento idóneo que permite la unión de dos tubos. Este sistema permite la recuperación de tubos, modificación de instalación y la realización de reparaciones.



Tuberías en polipropileno triple capa evacuación insonorizada

Tubo con 1 boca

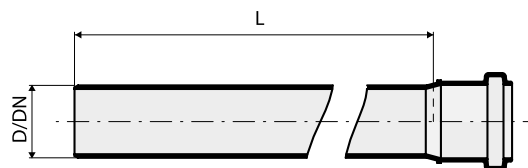

Referencia	D (mm)	DN (mm)	Espesor (mm)	L (mm)		Precio (€/ud.)
VS0650005	32	30	1,8	500	30	3,66
VS0650007	32	30	1,8	1000	24	5,72
VS0650013	32	30	1,8	3000	24	16,09
VS0650025	40	40	1,8	500	50	3,66
VS0650027	40	40	1,8	1000	20	5,72
VS0650031	40	40	1,8	2000	20	10,63
VS0650033	40	40	1,8	3000	20	15,90
VS0650045	50	50	1,8	500	35	3,96
VS0650047	50	50	1,8	1000	30	5,74
VS0650051	50	50	1,8	2000	30	11,82
VS0650053	50	50	1,8	3000	30	17,12
VS0650065	75	70	2,6	500	20	6,70
VS0650067	75	70	2,6	1000	20	9,48
VS0650071	75	70	2,6	2000	20	17,82
VS0650073	75	70	2,6	3000	20	26,49
VS0650085	90	90	3,1	500	24	8,98
VS0650087	90	90	3,1	1000	10	14,17
VS0650091	90	90	3,1	2000	10	26,88
VS0650093	90	90	3,1	3000	10	38,01
VS0650103	110	100	3,4	250	15	6,65
VS0650105	110	100	3,4	500	15	10,08
VS0650107	110	100	3,4	1000	15	15,77
VS0650111	110	100	3,4	2000	15	29,80
VS0650113	110	100	3,4	3000	15	43,22
VS0650125	125	125	3,9	500	6	14,16
VS0650127	125	125	3,9	1000	8	22,91
VS0650131	125	125	3,9	2000	8	42,31
VS0650133	125	125	3,9	3000	8	59,08
VS0650145	160	150	4,9	500	1	22,04
VS0650147	160	150	4,9	1000	6	34,30
VS0650151	160	150	4,9	2000	6	63,77
VS0650153	160	150	4,9	3000	6	90,61
VS0650167	200	200	6,2	1000	4	84,69
VS0650171	200	200	6,2	2000	4	146,63
VS0650173	200	200	6,2	3000	4	184,37
VS0650187	250	250	7,7	1000	4	139,53
VS0650193	250	250	7,7	3000	4	308,11

Referencias de tubo disponibles en stock, para otros largos de tubo consultar en atencionalcliente@italsan.com o en el 900 921 957

Accesorios en polipropileno monocapa evacuación insonorizada

Codo 15°

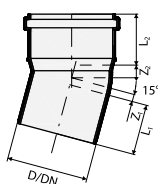

Referencia	D (mm)	DN (mm)	Z1 (mm)	L1 (mm)	Z2 (mm)	L2 (mm)		Precio (€/ud.)
VS0650411	40	40	4	47	8	44	50	2,28
VS0650421	50	50	4	48	8	46	30	3,16
VS0650451	110	100	9	61	16	59	20	7,59
VS0650461	125	125	10	66	17	64	20	14,22
VS0650471	160	150	12	45	22	73	1	22,22

Codo 30°

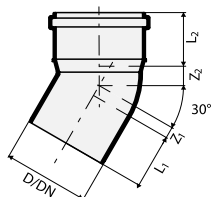

Referencia	D (mm)	DN (mm)	Z1 (mm)	L1 (mm)	Z2 (mm)	L2 (mm)		Precio (€/ud.)
VS0650413	40	40	7	47	10	44	50	2,28
VS0650423	50	50	8	48	12	46	30	2,88
VS0650453	110	100	17	61	23	59	20	7,59
VS0650463	125	125	18	66	26	64	20	14,22
VS0650473	160	150	23	75	33	73	1	22,22

Codo 45°

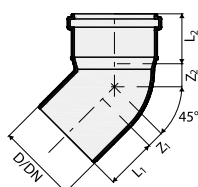

Referencia	D (mm)	DN (mm)	Z1 (mm)	L1 (mm)	Z2 (mm)	L2 (mm)		Precio (€/ud.)
VS0650405	32	30	8	45	10	44	80	2,26
VS0650415	40	40	10	47	14	44	50	2,28
VS0650425	50	50	11	48	17	46	30	2,78
VS0650435	75	70	18	53	22	52	20	4,99
VS0650445	90	90	21	56	26	56	20	6,78
VS0650455	110	100	25	61	31	59	20	7,10
VS0650465	125	125	28	66	35	64	15	14,22
VS0650475	160	150	35	75	45	73	1	22,22
VS0650485	200	200	63	180	86	170	1	137,28
VS0650495	250	250	57	210	88	203	1	247,44

Codo 67° 30'

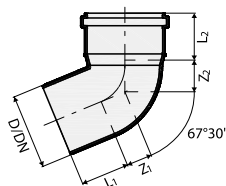

Referencia	D (mm)	DN (mm)	Z1 (mm)	L1 (mm)	Z2 (mm)	L2 (mm)		Precio (€/ud.)
VS0650417	40	40	15	47	19	44	50	2,44
VS0650427	50	50	18	48	22	46	30	3,92
VS0650457	110	100	40	61	45	59	20	8,02
VS0650467	125	125	43	66	51	64	15	20,84

Codo 87° 30'

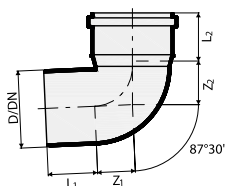

Referencia	D (mm)	DN (mm)	Z1 (mm)	L1 (mm)	Z2 (mm)	L2 (mm)		Precio (€/ud.)
VS0650409	32	30	20	45	19	44	60	2,44
VS0650419	40	40	22	47	25	44	50	2,44
VS0650429	50	50	26	48	30	46	30	3,08
VS0650439	75	70	40	53	43	52	20	6,51
VS0650449	90	90	46	56	51	56	20	7,22
VS0650459	110	100	57	61	61	59	20	7,59
VS0650469	125	125	62	66	70	64	10	20,84
VS0650479	160	150	78	75	89	73	1	34,45
VS0650489	200	200	148	180	172	170	1	160,15
VS0650499	250	250	122	210	163	203	1	272,87

Accesorios en polipropileno monocapa evacuación insonorizada

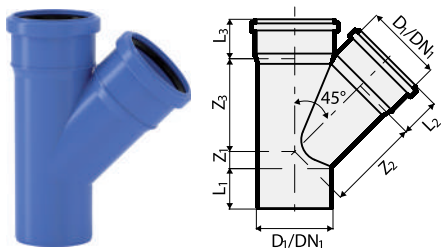

Derivación 45°

Referencia	D1 (mm)	DN1 (mm)	Z1 (mm)	L1 (mm)	Z2 (mm)	L2 (mm)	Z3 (mm)	L3 (mm)		Precio (€/ud.)
VS0650501	32	32	7	50	44	44	44	44	40	4,99
VS0650507	40	40	10	46	49	44	49	44	20	5,31
VS0650513	50	50	12	50	61	46	61	46	20	6,36
VS0650519	75	70	19	53	96	52	96	52	20	8,80
VS0650525	90	90	21	56	110	56	110	56	20	13,24
VS0650531	110	100	25	61	135	59	135	59	10	14,81
VS0650537	125	125	28	66	152	65	152	65	5	51,37
VS0650543	160	150	36	75	198	73	199	73	1	80,08
VS0650669 *	200	200	46	145	273	135	273	135	1	237,26
VS0650685 *	250	250	21	170	336	160	336	160	1	415,21

(*) Derivación manipulada

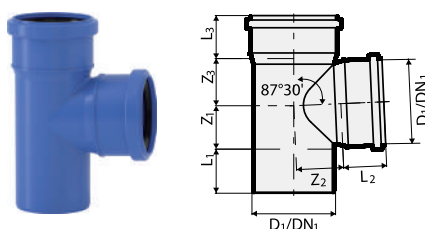

Derivación 87°30'

Referencia	D1 (mm)	DN1 (mm)	Z1 (mm)	L1 (mm)	Z2 (mm)	L2 (mm)	Z3 (mm)	L3 (mm)		Precio (€/ud.)
VS0650505	32	32	21	45	17	52	17	52	40	4,99
VS0650511	40	40	19	46	24	44	28	44	20	5,31
VS0650517	50	50	28	50	29	46	29	46	20	6,36
VS0650523	75	70	39	53	46	52	46	52	20	8,80
VS0650529	90	90	48	56	52	56	52	56	20	13,24
VS0650535	110	100	56	61	65	59	65	59	10	14,81
VS0650541	125	125	65	66	71	65	71	65	10	51,37
VS0650547	160	150	80	75	94	73	97	73	1	80,08
VS0650671 *	200	200	100	145	137	135	137	135	1	252,53
VS0650687 *	250	250	130	170	165	160	165	160	1	420,30

(*) Derivación manipulada

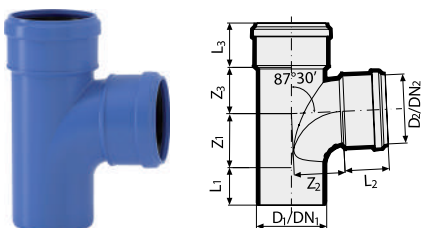

Derivación 87°30' curvada

Referencia	D1/D2 (mm)	DN1/DN2 (mm)	Z1 (mm)	L1 (mm)	Z2 (mm)	L2 (mm)	Z3 (mm)	L3 (mm)		Precio (€/ud.)
VS0650694	90/90	90/90	57	56	64	56	47	59	20	14,81
VS0650695	110/75	100/70	48	81	54	52	58	59	10	18,04
VS0650696	110/90	100/90	57	72	64	56	58	59	10	19,21
VS0650693	110/110	100/100	69	64	78	66	58	59	8	27,70

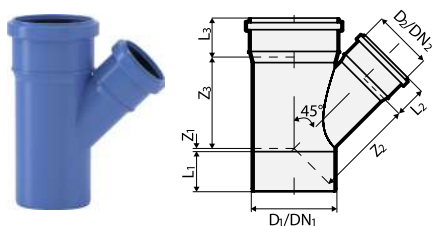

Derivación reducida 45°

Referencia	D1/D2 (mm)	DN1/DN2 (mm)	Z1 (mm)	L1 (mm)	Z2 (mm)	L2 (mm)	Z3 (mm)	L3 (mm)		Precio (€/ud.)
VS0650557	50/40	50/40	5	40	56	44	54	46	20	5,76
VS0650563	75/40	70/40	-7	46	79	44	71	52	25	8,80
VS0650575	90/40	90/40	-10	56	87	44	76	56	20	13,24
VS0650587	110/40	100/40	-24	61	99	44	89	59	20	14,81
VS0650593	110/50	100/50	-17	61	106	46	79	59	20	14,81
VS0650599	110/75	100/70	1	61	121	52	112	59	15	14,81
VS0650605	125/50	125/50	-24	66	114	46	111	65	10	33,85
VS0650611	125/110	125/100	18	66	146	59	142	65	8	33,85
VS0650617	160/110	150/100	6	75	185	59	171	73	1	53,32
VS0650623	160/125	150/125	12	75	184	65	174	73	1	53,32
VS0650629 *	200/110	200/100	-15	145	228	63	207	135	1	126,69
VS0650633 *	200/125	200/125	-7	145	237	74	220	135	1	135,96
VS0650637 *	200/160	200/150	19	145	255	77	245	135	1	171,17
VS0650643 *	250/110	250/100	37	170	263	63	237	160	1	225,39
VS0650647 *	250/160	250/150	-2	170	291	77	271	160	1	250,84
VS0650650 *	250/200	250/200	26	170	309	133	300	160	1	344,03

(*) Derivación manipulada

Accesorios en polipropileno monocapa evacuación insonorizada

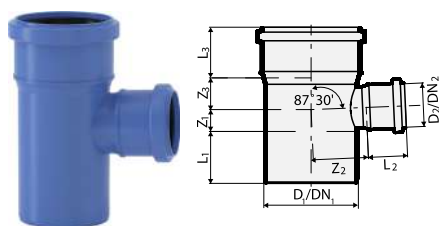

Derivación reducida 87° 30'

Referencia	D ₁ /D ₂ (mm)	DN ₁ /DN ₂ (mm)	Z ₁ (mm)	L ₁ (mm)	Z ₂ (mm)	L ₂ (mm)	Z ₃ (mm)	L ₃ (mm)		Precio (€/ud.)
VS0650567	75/40	70/40	22	53	47	44	30	52	25	8,80
VS0650579	90/40	90/40	23	56	50	44	29	56	15	13,24
VS0650591	110/40	100/40	21	61	62	44	32	59	20	14,81
VS0650597	110/50	100/50	26	61	64	46	37	59	20	14,81
VS0650603	110/75	100/70	38	61	67	52	49	59	15	14,81
VS0650609	125/50	125/50	28	66	68	46	36	65	10	33,85
VS0650615	125/110	125/100	58	66	72	59	64	65	8	33,85
VS0650621	160/110	150/100	55	75	93	59	71	73	1	53,32
VS0650627	160/125	150/125	64	75	93	65	79	73	1	53,32
VS0650631 *	200/110	200/100	55	145	135	63	100	135	1	172,88
VS0650635 *	200/125	200/125	62	145	133	74	100	135	1	179,64
VS0650639 *	200/160	200/150	79	145	138	77	116	135	1	186,44
VS0650645 *	250/110	250/100	59	170	160	63	96	160	1	259,28
VS0650649 *	250/160	250/150	84	170	175	77	120	160	1	284,73
VS0650651 *	250/200	250/200	124	170	160	135	140	160	1	372,85

(*) Derivación manipulada

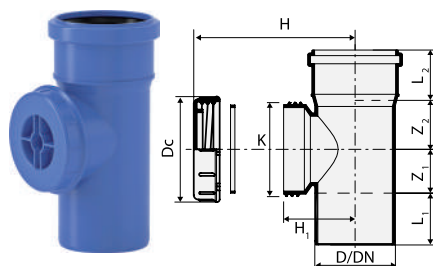

Inspección con tapón roscado

Referencia	D (mm)	DN (mm)	Z ₁ (mm)	L ₁ (mm)	Z ₂ (mm)	L ₂ (mm)	H (mm)	D _c (mm)	K (mm)	H ₁ (mm)		Precio (€/ud.)
VS0650901	50	50	36	48	35	46	65	90	74	57	20	11,34
VS0650903	75	70	40	53	43	52	85	90	74	66	20	13,89
VS0650905	90	90	49	58	55	56	90	120	105	80	20	18,39
VS0650907	110	100	55	61	65	59	100	120	105	90	15	21,62
VS0650909	125	125	65	66	71	65	105	150	128	98	10	42,30
VS0650911	160	150	64	75	75	63	125	150	128	118	1	65,13
VS0650913 *	200	200	76	145	110	135	150	150	128	142	1	236,67
VS0650915 *	250	250	81	170	113	160	165	150	128	158	1	331,59

(*) Derivación manipulada

Accesorios en polipropileno monocapa evacuación insonorizada

Derivación doble 45°

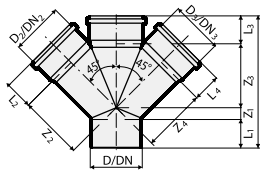

Referencia	D1/2/3 (mm)	DN1/2/3 (mm)	L (mm)	Z1 (mm)	L1 (mm)	Z2/3/4 (mm)	L2/3/4 (mm)		Precio (€/ud.)
VS0650652 *	75/75/75	70/70/70	230	-	54	96	52	1	91,06
VS0650653 *	90/90/90	90/90/90	243	-	58	110	56	1	102,85
VS0650655	110/110/110	100/100/100	280	25	61	136	59	5	29,62
VS0650658 *	125/125/125	125/125/125	319	-	72	152	64	1	144,10
VS0650660 *	160/160/160	150/150/150	394	-	75	195	77	1	228,66

(*) Derivación manipulada

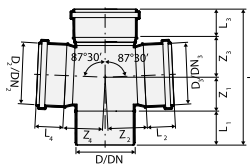

Derivación doble 87° 30'

Referencia	D1/2/3 (mm)	DN1/2/3 (mm)	L (mm)	Z1 (mm)	L1 (mm)	Z2/4 (mm)	L2/4 (mm)	Z3 (mm)	L3 (mm)		Precio (€/ud.)
VS0650654	110/50/50	100/50/50	181,5	25	60	63	44	42,5	54	5	77,90
VS0650656	110/110/110	100/100/100	249	64	60	72	52	73	52	5	77,90
VS0650659 *	125/110/110	125/100/100	252	59	65	79	52	72	56	5	138,90
VS0650667 *	160/110/110	150/100/100	289	61	84	100	52	81	63	1	234,61

(*) Derivación manipulada

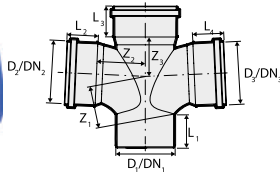

Derivación doble 87° 30' compacta

Referencia	D1/2/3 (mm)	DN1/2/3 (mm)	Z1 (mm)	L1 (mm)	Z2 (mm)	L2 (mm)	Z3 (mm)	L3 (mm)	L4 (mm)		Precio (€/ud.)
VS0652911	90/90/90	90/90/90	57	56	64	56	47	56	56	12	66,20
VS0652912	110/110/75	100/100/70	69	64	78	66	58	59	52	5	73,55
VS0652913	110/110/90	100/100/90	69	64	78	66	58	59	56	5	76,24
VS0652914	110/110/110	100/100/100	69	64	78	66	58	59	59	5	77,90

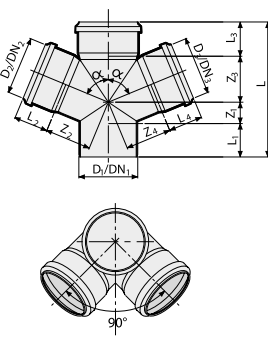

Derivación doble 87° 30' en ángulo

Referencia	D1/2/3 (mm)	DN1/2/3 (mm)	Z1 (mm)	Z2/4 (mm)	Z3 (mm)	L (mm)	L1 (mm)	L2/4 (mm)	L3 (mm)		Precio (€/ud.)
VS0650657	110/110/110	100/100/100	54	77	71	242	63	54	54	5	83,02
VS0650661	125/110/110	125/100/100	54	77	71	255	71	54	59	5	97,00
VS0650662 *	160/110/110	150/100/100	68	100	77	290	78	52	67	1	234,61

(*) Derivación manipulada

Accesorios en polipropileno monocapa evacuación insonorizada

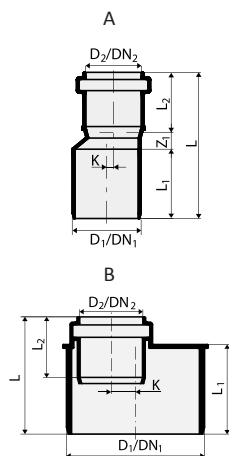

Reducción excéntrica

Referencia	Mod.	D ₁ /D ₂ (mm)	DN ₁ /DN ₂ (mm)	K (mm)	Z ₁ (mm)	L ₁ (mm)	L ₂ (mm)	L (mm)		Precio (€/ud.)
VS0650701	A	40/32	40/30	0	11	44	45	100	50	3,79
VS0650705	A	50/40	50/40	5	12	51	44	107	50	3,79
VS0650707	B	75/40	70/40	9	-	56	39	74	30	4,71
VS0650709	B	75/50	70/50	4	-	56	42	73	30	4,71
VS0650711	B	90/40	90/40	16	-	59	40	77	20	6,51
VS0650713	B	90/50	90/50	11	-	61	42	78	20	6,51
VS0650715	A	90/75	90/70	5	3	57	47	107	20	6,94
VS0650717	B	110/40	100/40	25	-	63	40	79	20	6,94
VS0650719	B	110/50	100/50	20	-	63	42	80	20	6,94
VS0650721	B	110/75	100/70	7	-	63	47	80	20	6,94
VS0650723	A	110/90	100/90	7	3	60	50	113	20	7,91
VS0650729	A	125/110	125/100	4	6	67	49	122	20	12,55
VS0650731	B	160/110	150/100	10	-	85	52	103	1	18,76
VS0650733	B	160/125	150/125	4	-	86	56	105	1	18,76
VS0650735 *	B	200/110	200/100	10	45	90	55	191	1	149,72
VS0650739 *	A	200/160	200/150	18	45	93	77	215	1	159,31
VS0650747 *	A	250/200	250/200	23	51	124	135	310	1	238,04

(*) Piezas manipuladas

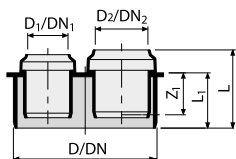

Reductor corto doble

Referencia	D/D ₁ /D ₂ (mm)	DN/DN ₁ /DN ₂ (mm)	Z ₁ (mm)	L (mm)	L ₁ (mm)		Precio (€/ud.)
VS0652990N	110/40/40	100/40/40	30	60	42	15	31,32

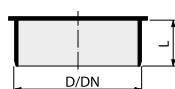

Tapón de cierre

Referencia	D (mm)	DN (mm)	L (mm)		Precio (€/ud.)
VS0650951	40	40	32	40	2,44
VS0650953	50	50	32	20	3,65
VS0650955	75	70	32	15	4,71
VS0650957	90	90	42	30	7,67
VS0650959	110	100	42	20	10,58
VS0650961	125	125	51	10	14,07
VS0650963	160	150	57	10	17,52

Accesorios en polipropileno monocapa evacuación insonorizada

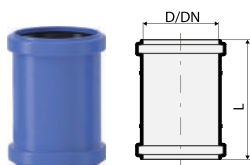

Manguito deslizante

Referencia	D (mm)	DN (mm)	L (mm)		Precio (€/ud.)
VS0650801	32	30	86	60	3,16
VS0650803	40	40	100	30	3,33
VS0650805	50	50	105	30	3,65
VS0650807	75	70	120	20	4,85
VS0650809	90	90	120	20	7,48
VS0650811	110	100	136	20	8,30
VS0650813	125	125	147	20	15,55
VS0650815	160	150	180	1	23,44
VS0650817	200	200	220	1	128,81
VS0650819	250	250	290	1	249,15

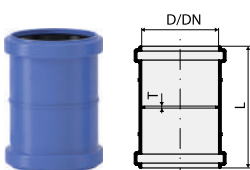

Manguito con tope

Referencia	D (mm)	DN (mm)	L (mm)	T (mm)		Precio (€/ud.)
VS0650851	32	30	80	2	60	3,16
VS0650853	40	40	100	2	30	3,33
VS0650855	50	50	105	2	30	3,65
VS0650857	75	70	120	2	20	4,85
VS0650859	90	90	120	3	20	7,48
VS0650861	110	100	136	3	20	8,30
VS0650863	125	125	147	3	20	15,55
VS0650865	160	150	180	3	1	23,44
VS0650867	200	200	220	4	1	128,81
VS0650869	250	250	290	4	1	249,15

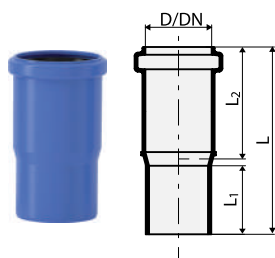

Boca doble profundidad

Referencia	D (mm)	DN (mm)	L1 (mm)	L2 (mm)	L (mm)		Precio (€/ud.)
VS0650759	110	100	61	100	169	20	11,65
VS0650761	125	125	66	108	182	10	15,41

Adaptadores entre distintos sistemas

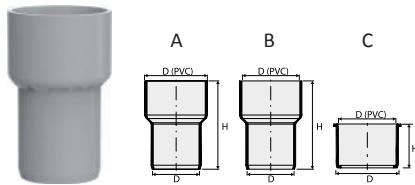

Adaptador en PVC, boca hembra para encolar PVC - macho unión TRIPLUS

Referencia	Mod.	D PVC (mm)	D TRIPLUS (mm)	H (mm)		Precio (€/ud.)
VS0531323	A	43	40	80	100	11,30
VS0531325	A	56	50	88,5	50	13,79
VS0531326	B	60	50	90	50	16,58
VS0531327	C	70	75	53	30	16,58
VS0531333	A	125	110	300	10	19,86
VS0531335	A	140	110	420	5	34,37
VS0531337	A	150	125	420	5	36,47

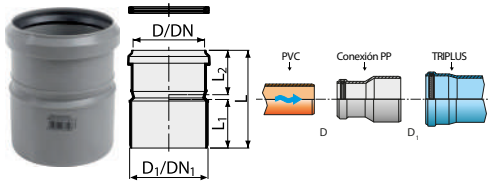

Adaptador en PP, boca hembra con junta unión PVC - macho unión TRIPLUS

Referencia	D/D ₁ (mm)	DN/DN ₁ (mm)	L (mm)	L ₁ (mm)	L ₂ (mm)		Precio (€/ud.)
VS0565001	100/110	100/100	138	69	63	20	9,47

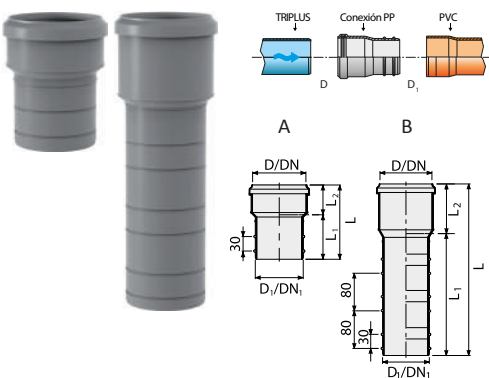

Adaptador en PP, boca hembra con junta unión TRIPLUS - macho con junta unión PVC

Referencia	Mod.	D/D ₁ (mm)	DN/DN ₁ (mm)	L (mm)	L ₁ (mm)	L ₂ (mm)		Precio (€/ud.)
VS0564001	A	110/100	100/100	156	95	60	20	9,73
VS0564003	B	110/100	100/100	367	265	100	15	10,73

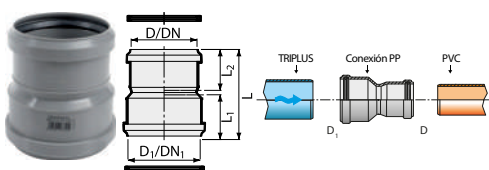

Adaptador en PP, doble boca hembra para unión PVC - TRIPLUS

Referencia	D/D ₁ (mm)	DN/DN ₁ (mm)	L (mm)	L ₁ (mm)	L ₂ (mm)		Precio (€/ud.)
VS0565022	100/110	100/100	134	63	63	20	10,22

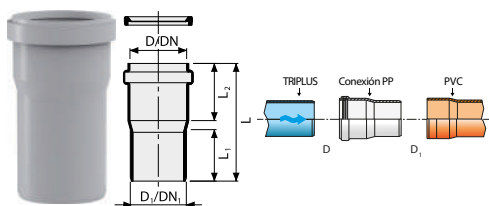

Adaptador en PVC, boca hembra con junta unión TRIPLUS - macho para encolar PVC

Referencia	D/D ₁ (mm)	DN/DN ₁ (mm)	L (mm)	L ₁ (mm)	L ₂ (mm)		Precio (€/ud.)
VS0564121	40/40	40/40	105	50	55	40	5,16
VS0564123	50/50	50/50	105	50	55	30	5,29
VS0564150	50/100	50/100	130	91	40	10	12,28
VS0564075	75/75	70/70	144	87	58	15	11,11
VS0564131	75/80	70/80	154	78	75	15	11,11
VS0564182	75/82	70/80	159	78	80	15	11,11
VS0564175	75/100	70/100	156	77	77	10	12,28
VS0564190	90/100	90/100	143	76	65	10	12,34
VS0564101	110/100	100/100	147	83	57	10	13,16
VS0564251	110/125	100/125	145	83	60	10	12,23

Adaptadores entre distintos sistemas

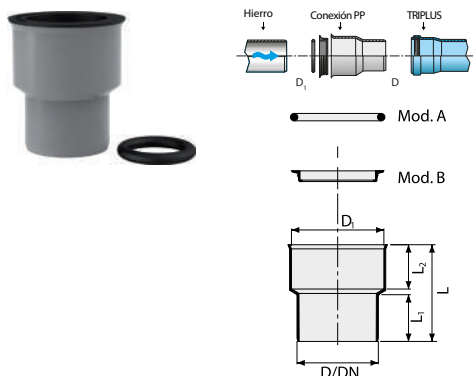

Adaptador en PP, boca hembra con doble sellado (anillo y junta tórica) unión HIERRO – macho unión TRIPLUS

Referencia	D/D ₁ (mm)	DN (mm)	L (mm)	L ₁ (mm)	L ₂ (mm)		Precio (€/ud.)
VS0569001	50/72	50	115	50,9	55	20	5,08
VS0569003	75/92	70	115	50,5	55,6	20	6,19
VS0569005	110/124	100	130	64,6	58,4	20	9,69
VS0569007	125/151	125	145,5	71,9	65	10	30,59

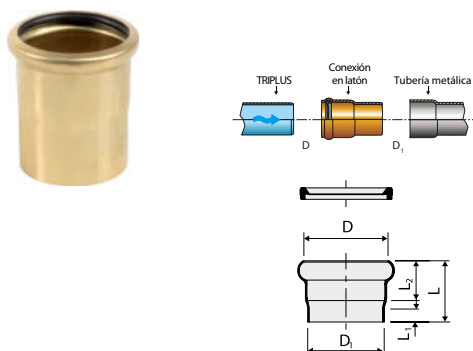

Adaptador de latón, boca hembra con junta unión TRIPLUS - macho unión Tubería metálica

Referencia	D (mm)	D ₁ (mm)	L (mm)	L ₁ (mm)	L ₂ (mm)		Precio (€/ud.)
VS0570001	32	32	61	26	33	40	7,71
VS0570002	40	32	59	28	25	40	7,71
VS0570003	40	40	55	25	25	40	7,71
VS0570005	50	50	-	-	-	40	8,76

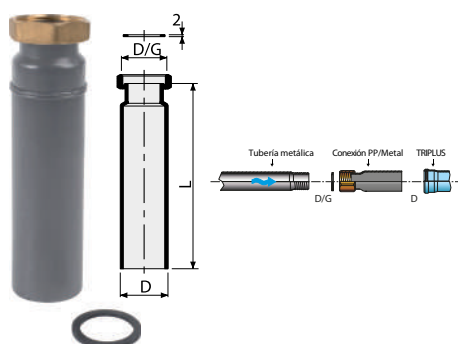

Adaptador prolongador en PP, adaptador rosca hembra unión Tubería metálica o plástica - macho unión TRIPLUS

Referencia	D/G (")	D (mm)	Rosca	L		Precio (€/ud.)
VS0700052	G 1 1/4"	40	Latón	195	20	20,99
VS0700064	G 1 1/2"	40	Latón	195	20	22,28
VS0700252	G 1 1/4"	40	Plástico	195	20	19,10
VS0700264	G 1 1/2"	40	Plástico	195	20	19,51
VS0700267	G 1 1/4"	50	Plástico	195	20	22,28

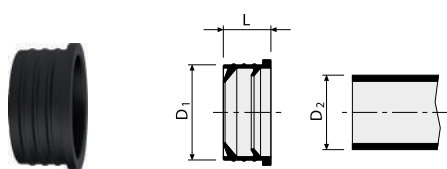

Adaptador elastomérico polivalente para conexión con otros sistemas

Referencia	D ₁ PP (mm)	D ₂ Metal (mm)	L (mm)		Precio (€/ud.)
VS0559001	40	26-28	24	50	2,35
VS0559003	40	30-32	25	50	2,35



Silicona lubricante

Referencia	Descripción		Precio (€/ud.)
VS0900001	Silicona 150 ml.	1	7,07

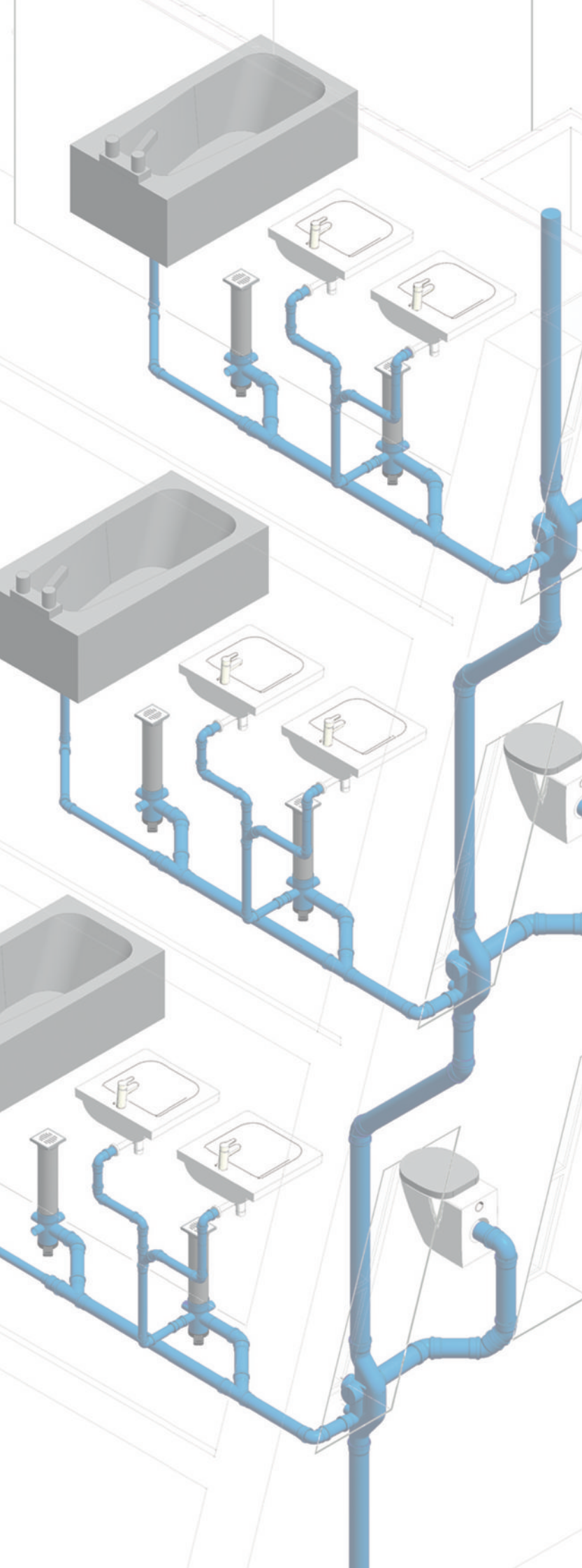

Soluciones en la instalación

Sistema TRIPLUS

Indice

Curva 87°30' radio largo



Tal y como se detalla en el **Documento Básico HS 5 de Evacuación de Aguas del Código Técnico de la Edificación**, la conexión de las bajantes a los colectores horizontales no deben realizarse mediante simples codos, ni codos reforzados.

Este hecho provoca que dicha conexión sea desarrollada mediante dos codos a 45° o un codo de radio largo.

Con el fin de simplificar la instalación y asegurar la respuesta acústica en la conexión, se ha diseñado la curva a 87°30' de radio largo, desarrollada simulando una conexión mediante dos codos a 45°.

Esta solución da respuesta en una ubicación estratégica, reduciendo la repercusión sonora debido a las descargas y amortiguando debidamente el ruido en un punto sometido a grandes impactos.

Sistema TRIPLUS

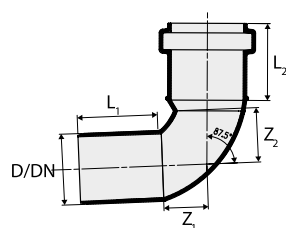

Curva 87° 30' radio largo

Referencia	D (mm)	DN (mm)	Z1 (mm)	L1 (mm)	Z2 (mm)	L2 (mm)		Precio (€/ud.)
VS0652901	40	40	25	45	30	43	50	3,61
VS0652902	50	50	31	46	37	45	30	4,69
VS0652903	75	70	48	56	54	52	15	9,50
VS0652904	90	90	57	56	64	56	20	10,72
VS0652905	110	100	69	64	78	59	20	11,11

TRIPLUS Multiconexión



TRIPLUS Multiconexión ha sido concebida para mejorar y simplificar el sistema de instalación, aportando máxima libertad en la implantación de aparatos sanitarios.

- Conexiones directas a diámetros de 32 a 56 mm sin utilización de reducciones.
- Fabricado con material **TRIPLUS** asegurando las características acústicas del sistema.
- Reducción del riesgo de obturación.
- Mejora en el mantenimiento.

Sistema TRIPLUS

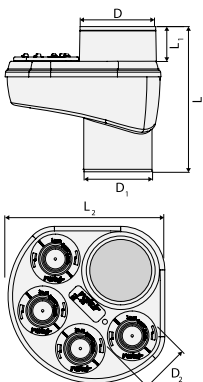

TRIPLUS multiconexión

Referencia	D (mm)	D1 (mm)	D2 (mm)	L (mm)	L1 (mm)	L2 (mm)		Precio (€/ud.)
VS0652001	110/110	110/110	4 x 32-56	230	55	250	2	141,65

TRIPLUS Bote sifónico inspeccionable



El **bote sifónico inspeccionable TRIPLUS** da respuesta a las necesidades encontradas en las instalaciones actuales, permitiendo su colocación suspendido bajo forjado.

- Dotado de soporte orientable para sujeción directa a forjado.
- Gran accesibilidad.
- Sello hidráulico de 75 mm.
- 100% material **TRIPLUS** garantizando el comportamiento acústico del sistema.
- Diámetro de bote 110 mm para conexión directa con tubería insonorizada **TRIPLUS** 110mm.
- Compuesto por tres entradas de $\varnothing 50$ mm y una salida de $\varnothing 75$ mm.

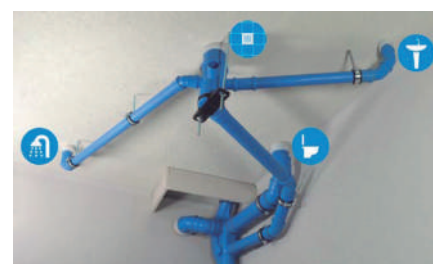

Sistema TRIPLUS

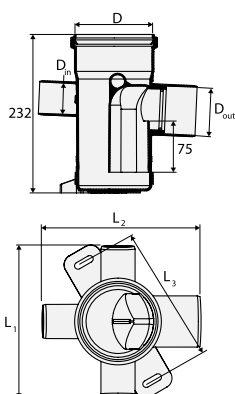

Bote sifónico TRIPLUS inspeccionable

Referencia	D (mm)	D _{in} (mm)	D _{out} (mm)	L ₁ (mm)	L ₂ (mm)	L ₃ (mm)		Precio (€/ud.)
VS0701741	110	3 x 50	1 x 75	220	230	200	5	59,26

- Bote sifónico Triplus formado por tres entradas de $\varnothing 50$ mm y una salida de 75mm. Las entradas son ciegas a efectos de ser perforadas en función de las necesidades.
- Incluye sello hidráulico. Altura de sello hidráulico de 75 mm.
- Conexiones directas con bocas hembra mediante junta elástica.
- Se incluye el sistema de soportación inferior que lo hace 360º orientable y ajustable a la altura respecto a forjado.

Ver Complementos en apartado **SIFONES y BOTES SIFÓNICOS**

Válvula de admisión de aire



- Testadas y certificadas según norma EN12380, con marcado CE.
- Cumple plenamente con los requisitos de proyecto e instalación de la norma EN 12056.
- Permite la ventilación de tramos mayores a 4 m, evitando un sistema de ventilación indirecta.
- En caso de instalación en terrazas evita la fuga de olores de la bajante.
- Elimina el riesgo de sifonamiento.
- Facilidad de instalación mediante Plug-in, incluso en espacios confinados.

Válvula de admisión de aire

Referencia	Mod.	D (mm)	D ₁ /D ₂ /D ₃ /D ₄ /D ₅ (mm)	L/L ₁ (mm)		Precio (€/ud.)
VS0700401	A	70	32/40/50/63/-	79,5/35	12	81,56
VS0700402	B	125	70/75/90/100/110	108/46	6	159,55

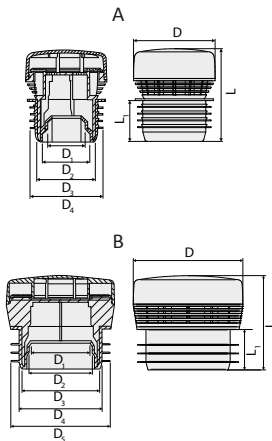

VENTILACIÓN

Terminal del ventilación en PP Gris

Referencia	D (mm)	DN (mm)	D ₁ /D ₂ (mm)	L (mm)	H (mm)		Precio (€/ud.)
VS0394010	50	50	100/120	705	53	10	57,09
VS0394011	75	75	100/145	705	53	5	63,55
VS0394012	90	90	135/160	705	53	5	67,58
VS0394013	110	100	135/180	705	53	5	71,56

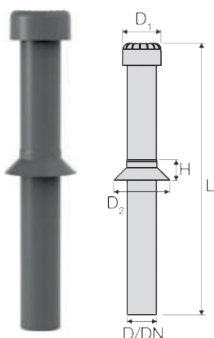

Collarines intumescentes

Compatibles para instalaciones con gamas de sistemas PP3–TRIPLUS–SILERE–HDPE.

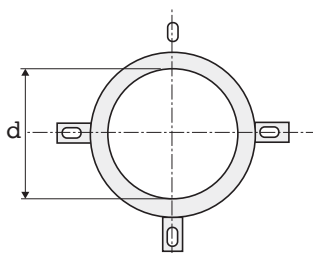
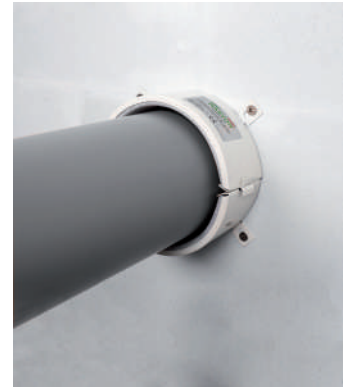
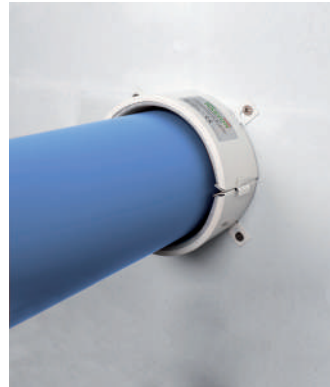

Collarines intumescentes

Referencia	D interno (mm)	Nº Fijaciones		Precio (€/ud.)
VS0411051	32	4	1	92,98
VS0411053	40	4	1	98,04
VS0411055	55	4	1	105,07
VS0411057	63	4	1	111,18
VS0411059	75	4	1	113,19
VS0411061	82	4	1	114,05
VS0411063	90	4	1	123,30
VS0411065	110	4	1	128,36
VS0411067	125	4	1	133,41
VS0411069	140	4	1	151,61
VS0411071	160	4	1	166,76
VS0411073	200	6	1	Consultar
VS0411075	250	6	1	Consultar
VS0411077	315	6	1	Consultar

Silicona Tecno –S 240



Referencia	Descripción		Precio (€/ud.)
VS0411090	Silicona 310 ml	25	Consultar



Sistema de evacuación con derivación de ventilación

TRIPLUS Derivación de ventilación

La alternativa a la ventilación secundaria y terciaria

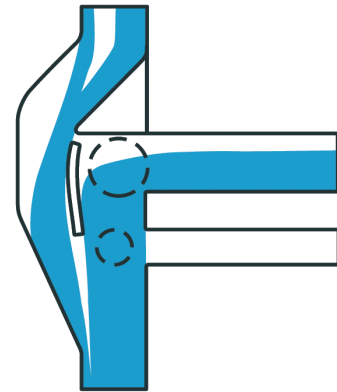

D 110 / 160
(DN 100 / 150)



D 110
(DN 100)

D 75
(DN 70)

En el apartado **Subsistemas de ventilación de las instalaciones** del **Documento Básico HS 5 de Evacuación de Aguas del Código Técnico de la Edificación**, se requiere un subsistema de ventilación secundaria en aquellos edificios de 7 o más plantas, realizando una conexión a la bajante en plantas alternas en los edificios menores a 15 plantas y una conexión en cada planta en edificios de 15 plantas o superiores.

En el mismo Documento Básico se establece que se requiere un subsistema de ventilación terciaria en aquellos edificios que tengan más de 14 plantas o dispongan de ramales de desagüe con una longitud superior a 5 m hasta la bajante.

La utilización de la derivación de ventilación evita la realización de los subsistemas de ventilación secundaria y terciaria, aportando los siguientes beneficios:

- Reducción del espacio necesario en los patinillos donde se albergan las bajantes.
- Aminoración de la velocidad del flujo de descarga.
- Disminución de la rumorosidad gracias a la disminución de la velocidad.
- Aseguramiento de la ventilación.
- Evita la formación de tapones hidráulicos en los puntos de conexión con las ramales.
- Simplificación en la instalación.

Sistema de evacuación con derivación de ventilación

- La derivación de ventilación está prevista para colocación en columnas D110 / 160 (DN 100 / 150).
- La derivación de ventilación se suministra con salida principal abierta a D110 y 160 mm. y el resto de salidas son ciegas para apertura según necesidades en la instalación.

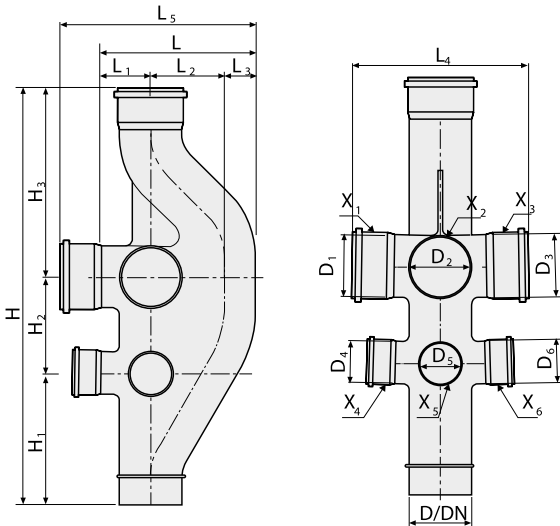

Derivación de ventilación, ref. VS0651X₁X₂X₃X₄X₅X₆*

D (mm)	DN (mm)	D _{1/2/3} (mm)	D _{4/5/6} (mm)	L (mm)	L ₁ (mm)	L ₂ (mm)	L ₃ (mm)	L ₄ (mm)	L ₅ (mm)	H (mm)	H ₁ (mm)	H ₂ (mm)	H ₃ (mm)
110	100	110	75	265	85	130	50	300	345	780	245	170	365

* X=0 si la entrada no dispone de boca soldada / X=1 si la entrada dispone de boca soldada

X₁, X₂, X₃ = diámetro 110 mm

X₄, X₅, X₆ = diámetro 75 mm

Derivación de ventilación, ref. VS0654X₁X₂X₃X₄X₅X₆*

D (mm)	DN (mm)	D _{1/2/3} (mm)	D _{4/5/6} (mm)	L (mm)	L ₁ (mm)	L ₂ (mm)	L ₃ (mm)	L ₄ (mm)	L ₅ (mm)	H (mm)	H ₁ (mm)	H ₂ (mm)	H ₃ (mm)
160	150	110	75	300	100	145	55	340	380	880	310	170	400

* X=0 si la entrada no dispone de boca soldada / X=1 si la entrada dispone de boca soldada

X₁, X₂, X₃ = diámetro 110 mm

X₄, X₅, X₆ = diámetro 75 mm

La derivación de ventilación también se encuentra disponible para la gama de tuberías fonoabsorbentes **SILERE**.

Para más información técnica y/o estudio y presupuesto económico, contactar en el 900 921 957 o bien a través del mail atencionalcliente@italsan.com

Sistema de evacuación con derivación de ventilación

Sistema con ventilación secundaria

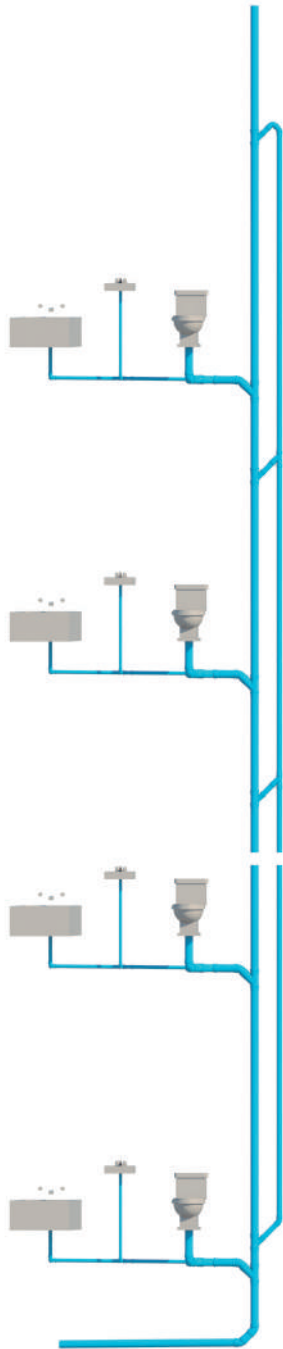

Sistema con ventilación terciaria

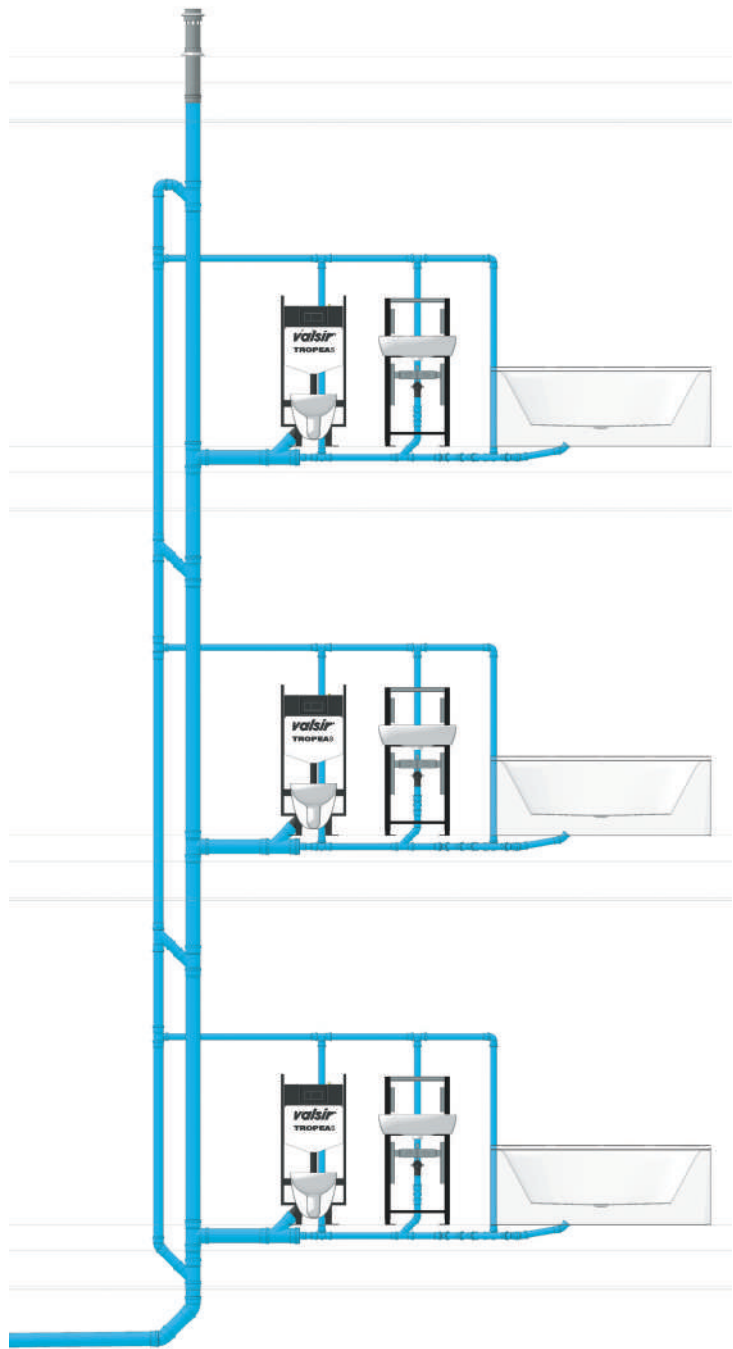

Diámetro 110 mm

Caudal máximo (l/s)	Número máximo de viviendas
5,6	33

Diámetro 160 mm

Caudal máximo (l/s)	Número máximo de viviendas
12,4	161

Sistema de evacuación con derivación de ventilación

Sistema con derivaciones de ventilación

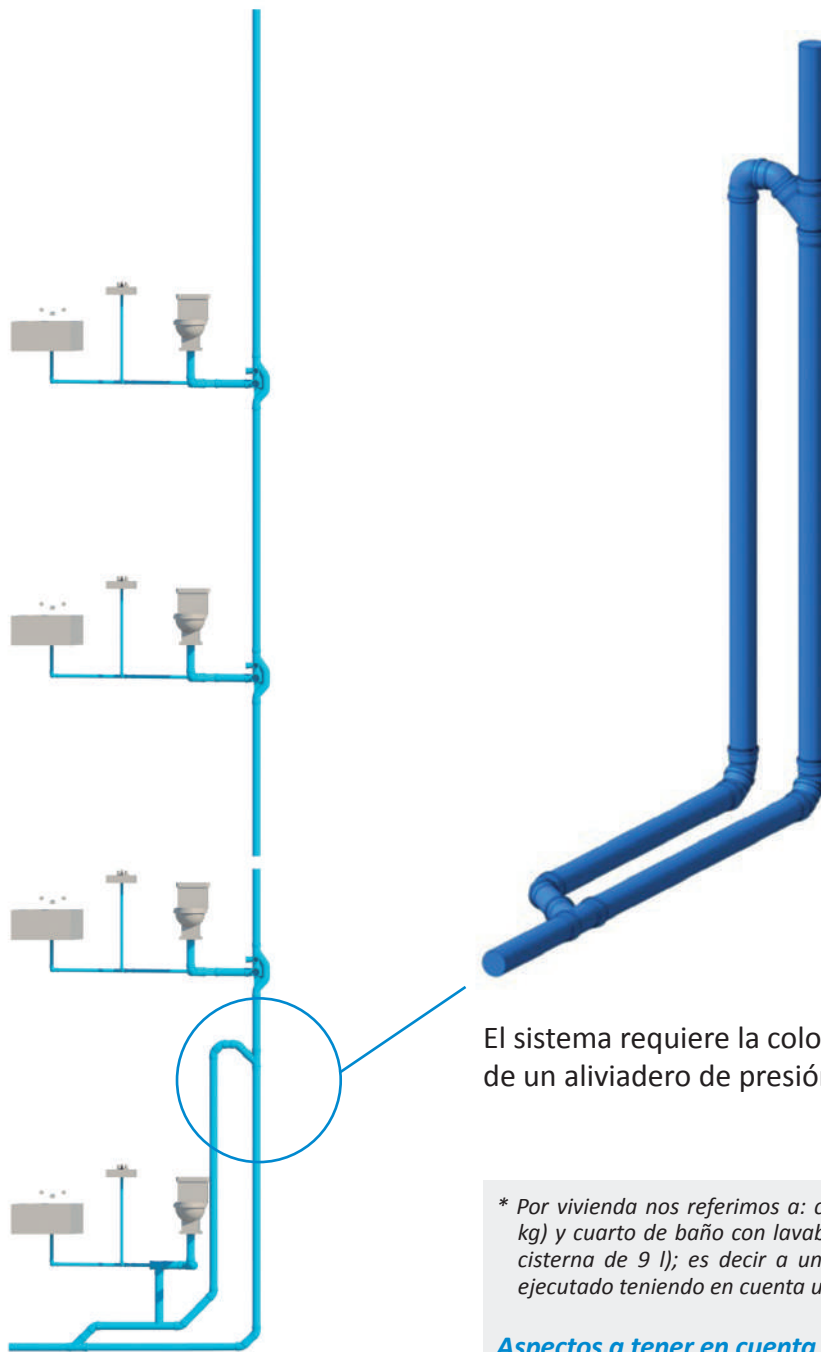

El sistema requiere la colocación de un aliviadero de presión.

* Por vivienda nos referimos a: cocina con fregadero y lavavajillas (max 6 kg) y cuarto de baño con lavabo, bañera, lavadora, bidet e inodoro (con cisterna de 9 l); es decir a un caudal total de 6,7 l/s. El cálculo se ha ejecutado teniendo en cuenta un factor de contemporaneidad $K=0,5$.

Aspectos a tener en cuenta

Valores superiores a 10 l/s

Están permitidos, pero su uso está vinculado al diseño del sistema y a las elecciones que caracterizan al proyecto (cambios de dirección, longitud de los ramales, número de sanitarios por planta, ventilaciones comunes, etc.). En estos casos se aconseja involucrar en el proyecto al Dpto. Técnico de Italsan.

Valores superiores a 21,1 l/s

Están permitidos, pero su uso está vinculado al diseño del sistema y a las elecciones que caracterizan al proyecto (cambios de dirección, longitud de los ramales, número de sanitarios por planta, ventilaciones comunes, etc.). En estos casos se aconseja involucrar en el proyecto al Dpto. Técnico de Italsan.

Diámetro 110 mm

Caudal máximo (l/s)	Número máximo de viviendas
13	100 *

Diámetro 160 mm

Caudal máximo (l/s)	Número máximo de viviendas
27,4	448 *



PP/PP3 PHONO



Sistema en PP
fonoabsorbente.
La alternativa
al PVC

Tubería PP triple capa fonoabsorbente para evacuación

El sistema **PP/PP3 Phono** se compone de la tubería en polipropileno triple capa fonoabsorbente y accesorios en polipropileno para la evacuación de aguas residuales y pluviales a baja y alta temperatura.

Capa intermedia

Reforzada con carga mineral. Permite alta resistencia mecánica incluso a baja temperatura.

Campana y espiga de acoplamiento con junta de labio

La campana y espiga de acoplamiento lleva una junta de labio que asegura la estanqueidad hidráulica y el deslizamiento del tubo por efecto de las dilataciones térmicas.



Capa exterior

Polipropileno color gris. Perfecta protección mecánica y resistencia a la abrasión.

Capa interior

Polipropileno color blanco. Excelente resistencia a los agentes químicos.

Características

- Sistema de unión por junta elastomérica monolabial.
- Producto reciclable.
- Declaración libre de halógenos.
- Certificado Fraunhofer nivel de fonoabsorbencia 17 dB(A) con caudal de descarga 2 l/s según EN14366.

Aplicaciones

- Evacuación agua residuales hasta 95 °C.
- Ventilación primaria, secundaria y terciaria.
- Evacuación aguas pluviales.
- Sistemas gravitatorios industriales.
- Evacuación de condensados de circuitos de climatización.

La instalación

Sistema de unión mediante boca con junta elastomérica monolabial

El sistema **PP/PP3 Phono** garantiza una instalación rápida y sin el uso de adhesivos, equipos eléctricos o maquinaria especial gracias al sistema de unión con junta labial.



Sistema de unión mediante manguito corredizo

El sistema **PP/PP3 Phono** dispone del manguito corredizo, el acoplamiento idóneo que permite la unión de dos tubos. Este sistema permite la recuperación de tubos, modificación de instalación y la realización de reparaciones.

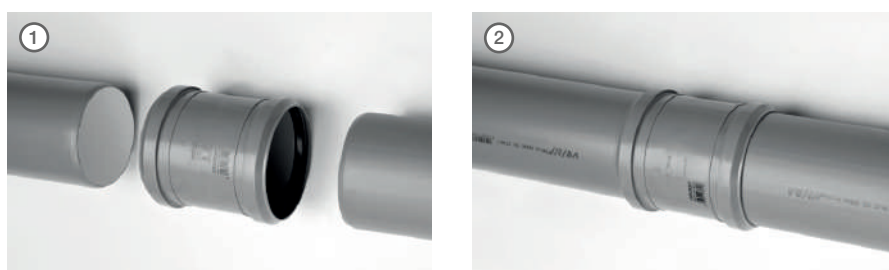

Tubería en PP triple capa fonoabsorbente

Tubo con 1 boca

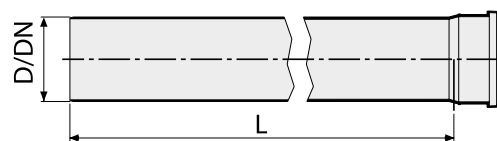

Referencia	D (mm)	DN (mm)	Espesor (mm)	L (mm)		Precio (€/ud.)
VS0501025	40	40	1,8	500	20	3,33
VS0501029	40	40	1,8	1000	20	4,29
VS0501035	40	40	1,8	3000	20	11,91
VS0501045	50	50	1,8	500	20	2,95
VS0501049	50	50	1,8	1000	30	4,68
VS0501055	50	50	1,8	3000	30	12,62
VS0501075	75	70	1,9	3000	20	19,11
VS0501155	90	90	2,2	3000	10	27,44
VS0501085	110	100	2,7	500	10	7,65
VS0501089	110	100	2,7	1000	15	13,32
VS0501095	110	100	2,7	3000	15	36,45
VS0501109	125	125	3,1	1000	8	17,50
VS0501115	125	125	3,1	3000	8	47,59
VS0501129	160	150	3,9	1000	6	28,24
VS0501135	160	150	3,9	3000	6	76,61
VS0650167 (*)	200	200	6,2	1000	4	84,69
VS0650173 (*)	200	200	6,2	3000	4	184,37
VS0650187 (*)	250	250	7,7	1000	4	139,53
VS0650193 (*)	250	250	7,7	3000	4	308,11

(*) TRIPLUS

Referencias de tubo disponibles en stock, para otros largos de tubo consultar en atencionalcliente@italsan.com o en el 900 921 957

Accesorios en PP fonoabsorbente

Derivación doble

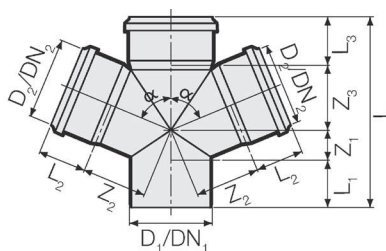

Referencia	D1/D2 (mm)	DN1/ DN2 (mm)	α	Z1 (mm)	Z2 (mm)	Z3 (mm)	L (mm)	L1 (mm)	L2 (mm)	L3 (mm)		Precio (€/ud.)
VS0506001	50/50	50/50	67°30'	20	40	41	172	58	53	53	20	13,13
VS0506005	75/75	70/70	67°30'	28	59	59	206	64	55	55	10	17,12
VS0599085	90/40	90/40	45°	15	85	85	215	58	51,5	57	15	13,52
VS0599087	90/50	90/50	45°	7	90,5	90,5	212,5	58	49,5	57	15	13,52
VS0506008	110/40	100/40	45°	16	104	90,5	239	72	50	60,5	10	18,57
VS0506010	110/50	100/50	45°	16	110	91	227	62	50	58	10	18,57
NEW VS0506019	110/110	100/110	45°	25	136	136	280	61	59	59	5	23,75
VS0506009	110/50	100/50	67°30'	8	78	54	192	68	50	62	10	13,52
VS0506011	110/50	100/50	87°30'	28	60	32	185	60	55	65	10	13,52
VS0506013	110/110	100/100	67°30'	40	86	86	257	66	63	65	5	19,29
VS0506015	110/110	100/100	87°30'	57	84	86	278	70	63	65	5	19,29

Accesorios en PP fonoabsorbente

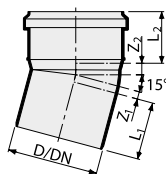

Codo 15°

Referencia	D (mm)	DN (mm)	Z1 (mm)	L1 (mm)	Z2 (mm)	L2 (mm)		Precio (€/ud.)
VS0504049	110	100	14	63	14	60	20	4,35
VS0504061	125	125	15	69	15	72	20	10,03
VS0504073	160	150	35	79	19	73	10	17,94

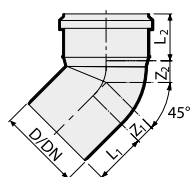

Codo 45°

Referencia	D (mm)	DN (mm)	Z1 (mm)	L1 (mm)	Z2 (mm)	L2 (mm)		Precio (€/ud.)
VS0504017	40	40	9	51	14	53	50	1,06
VS0504029	50	50	12	52	16	51	30	1,22
VS0504041	75	70	20	55	21	54	20	2,11
VS0599045	90	90	22	58	25	57	20	4,07
VS0504053	110	100	30	63	29	61	20	5,69
VS0504065	125	125	33	69	33	72	15	10,03
VS0504077	160	150	42	79	42	85	10	17,94
VS0650485 *	200	200	63	180	86	170	1	137,28
VS0650495 *	250	250	57	210	88	203	1	247,44

(*) TRIPLUS

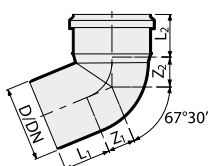

Codo 67° 30'

Referencia	D (mm)	DN (mm)	Z1 (mm)	L1 (mm)	Z2 (mm)	L2 (mm)		Precio (€/ud.)
VS0504019	40	40	16	51	20	53	50	1,18
VS0504031	50	50	20	51	23	51	30	1,35
VS0504055	110	100	44	63	44	65	20	5,69
VS0504067	125	125	49	69	50	72	15	11,42

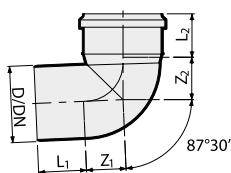

Codo 87° 30'

Referencia	D (mm)	DN (mm)	Z1 (mm)	L1 (mm)	Z2 (mm)	L2 (mm)		Precio (€/ud.)
VS0504023	40	40	23	51	26	53	50	1,13
VS0504035	50	50	30	52	31	57	30	1,31
VS0504047	75	70	40	55	43	55	20	2,19
VS0599051	90	90	48	58	51	57	20	4,89
VS0504059	110	100	57	63	61	66	20	6,16
VS0504071	125	125	71	69	70	72	10	10,57
VS0504083	160	150	87	79	89	85	10	22,66
VS0650489 *	200	200	148	180	172	170	1	160,15
VS0650499 *	250	250	122	210	163	203	1	272,87

(*) TRIPLUS

Accesorios en PP fonoabsorbente

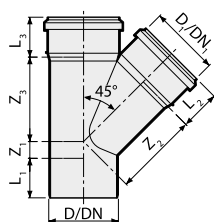

Derivación 45°

Referencia	D/D ₁ (mm)	DN/DN ₁ (mm)	Z ₁ (mm)	Z ₂ (mm)	Z ₃ (mm)	L ₁ (mm)	L ₂ (mm)	L ₃ (mm)		Precio (€/ud.)
VS0508007	40/40	40/40	10	49	49	50	60	60	20	2,28
VS0508013	50/50	50/50	12	61	61	53	55	54	20	3,28
VS0508019	75/75	70/70	18	91	91	57	54	54	20	4,11
VS0599061	90/90	90/90	22	110	110	58	57	57	20	6,08
VS0508025	110/110	100/100	25	134	134	64	63	63	15	10,43
VS0508031	125/125	125/125	28	152	152	69	68	69	10	29,87
VS0508037	160/160	150/150	36	194	194	94	87	86	1	66,95
VS0650669 *	200	200	46	145	273	135	273	135	1	237,26
VS0650685 *	250	250	21	170	336	160	336	160	1	415,21

(*) TRIPLUS, Piezas manipuladas

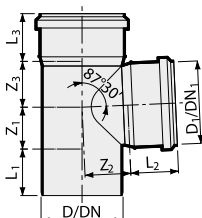

Derivación 87° 30'

Referencia	D/D ₁ (mm)	DN/DN ₁ (mm)	Z ₁ (mm)	Z ₂ (mm)	Z ₃ (mm)	L ₁ (mm)	L ₂ (mm)	L ₃ (mm)		Precio (€/ud.)
VS0508011	40/40	40/40	23	25	25	64	60	59	20	2,28
VS0508017	50/50	50/50	28	32	30	54	49	49	20	3,28
VS0508023	75/75	70/70	40	25	43	59	54	55	20	4,11
VS0599065	90/90	90/90	48	52	52	58	57	57	20	5,96
VS0508029	110/110	100/100	57	60	62	62	65	65	20	7,08
VS0508035	125/125	125/125	65	69	70	68	68	68	10	49,52
VS0508041	160/160	150/150	83	150	89	160	87	87	4	77,23
VS0650671 *	200	200	100	145	137	135	137	135	1	252,53
VS0650687 *	250	250	130	170	165	160	165	160	1	420,30

(*) TRIPLUS, Piezas manipuladas

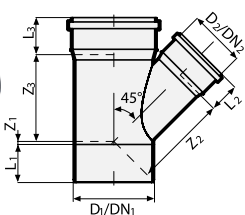

Derivación reducida 45°

Referencia	D/D ₁ (mm)	DN/DN ₁ (mm)	Z ₁ (mm)	Z ₂ (mm)	Z ₃ (mm)	L ₁ (mm)	L ₂ (mm)	L ₃ (mm)		Precio (€/ud.)
VS0510007	50/40	50/40	5	56	54	53	57	54	20	3,04
VS0510019	75/50	70/50	-1	80	74	58	54	54	25	3,65
VS0599073	90/50	90/50	-7	90,5	82	58	49,5	57	25	4,24
VS0510025	110/40	100/40	-24	101	84	55	51	63	15	4,51
VS0510031	110/50	100/50	-17	96	91	47	49	63	20	4,56
VS0510037	110/75	100/75	1	120	109	63	55	65	20	6,34
VS0510049	125/110	125/100	18	137	141	89	69	69	20	20,19
VS0510061	160/110	150/100	1	171	159	99	70	82	20	62,37

Derivación reducida 87° 30'

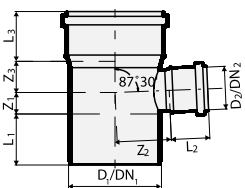

Referencia	D ₁ /D ₂ (mm)	DN ₁ /DN ₂ (mm)	Z ₁ (mm)	Z ₂ (mm)	Z ₃ (mm)	L ₁ (mm)	L ₂ (mm)	L ₃ (mm)		Precio (€/ud.)
VS0510011	50/40	50/40	23	30	25	54	50	50	25	3,19
VS0510023	75/50	70/50	27	25	31	58	50	54	25	3,89
VS0599077	90/50	90/50	28	50	32	58	49,5	57	20	4,30
VS0510035	110/50	100/50	28	62	32	60	50	64	20	4,95
VS0510041	110/75	100/75	40	61	45	61	55	65	15	6,55
VS0599091	110/90	100/90	40,7	62,4	51,5	62,3	57,5	60,5	10	18,89
VS0510053	125/110	125/100	58	70	63	83	63	68	8	22,89
VS0510065	160/110	150/110	58	86	64	99	72	84	5	62,67

Accesorios en PP fonoabsorbente

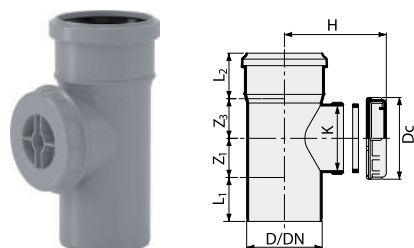

Inspección lineal con tapón

Referencia	D (mm)	DN (mm)	Z1 (mm)	Z3 (mm)	L1 (mm)	L2 (mm)	K (mm)	Dc (mm)	H (mm)		Precio (€/ud.)
VS0516007	110	100	57	62	61	67	105	118	100	15	8,76

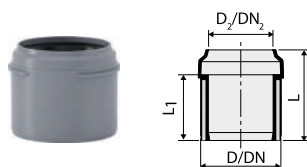

Reducción

Referencia	D/D2 (mm)	DN/DN2 (mm)	L (mm)	L1 (mm)		Precio (€/ud.)
VS0599135	90/75	90/70	76	61	20	3,56
VS0599137	110/90	100/90	81,5	65	20	3,98
VS0514015	125/110	125/110	86	68	30	12,23

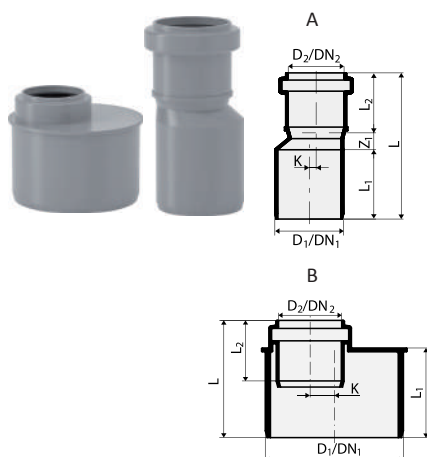

Reducción excéntrica

Referencia	Mod.	D/D2 (mm)	DN/DN2 (mm)	K (mm)	Z1 (mm)	L (mm)	L1 (mm)	L2 (mm)		Precio (€/ud.)
VS0514003	A	50/40	50/40	5	13	125	51	58	50	1,46
VS0514005	B	75/40	70/40	11	54	75	60	58	30	2,32
VS0514007	B	75/50	70/50	5	50	75	59	58	30	2,04
VS0599133	B	90/50	90/50	11	-	76	61	45,5	20	3,36
VS0514009	B	110/50	100/50	9	50	82	66	54	20	3,48
VS0514011	B	110/75	100/75	16	55	82	66	56	20	3,48
VS0514043	A	125/110	125/110	7	12	138	64	62	20	11,44
VS0514017	B	160/110	150/100	10	80	173	97	81	20	17,96
VS0514019	B	160/125	150/125	4	80	160	92	82	20	17,49
VS0650739 *	A	200/160	200/150	18	45	93	77	215	1	159,31

(*) TRIPLUS, Piezas manipuladas

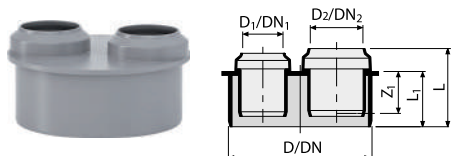

Reductor corto doble

Referencia	D/D1/D2 (mm)	DN/DN1/DN2 (mm)	Z1 (mm)	L (mm)	L1 (mm)		Precio (€/ud.)
VS0525003	110/40/40	100/40/40	30	60	42	15	24,59
VS0525005 *	125/40/50	125/40/50	30	67	57	10	31,74

(*) Pieza manipulada

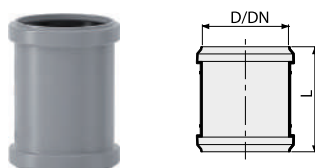

Manguito deslizante

Referencia	D (mm)	DN (mm)	L (mm)		Precio (€/ud.)
VS0526001	40	40	108	30	1,59
VS0526003	50	50	108	30	1,74
VS0526005	75	70	120	20	2,95
VS0599101	90	90	120	20	4,20
VS0526007	110	100	136	20	4,74
VS0526009	125	125	147	20	11,86
VS0526011	160	150	204	10	20,84

Accesorios en PP fonoabsorbente

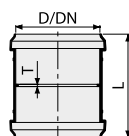

Manguito con tope

Referencia	D (mm)	DN (mm)	L (mm)	T (mm)		Precio (€/ud.)
VS0528001	40	40	108	2	30	1,59
VS0528003	50	50	108	2	30	1,74
VS0528005	75	70	120	2	20	2,82
VS0599111	90	90	120	2	20	4,20
VS0528007	110	100	136	3	20	4,55
VS0528009	125	125	147	3	20	11,86
VS0528011	160	150	210	28	10	19,91
VS0650867 *	200	200	200	200	1	128,81
VS0650869 *	250	250	250	250	1	249,15

(*) TRIPLUS

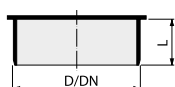

Tapón

Referencia	D (mm)	DN (mm)	L (mm)		Precio (€/ud.)
VS0524001	40	40	32	40	0,92
VS0524003	50	50	32	20	1,13
VS0524005	75	70	32	15	1,46
VS0599141	90	90	35	30	2,63
VS0524007	110	100	40	20	2,27
VS0524009	125	125	47	10	5,30
VS0524011	160	150	48	10	10,20

Adaptadores entre distintos sistemas

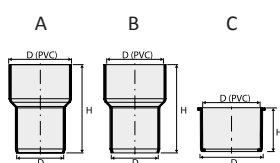

Adaptador en PVC, boca hembra para encolar PVC - macho unión PP/PP3 Phono

Referencia	Mod.	D PVC (mm)	D PP/PP3 Phono (mm)	H (mm)		Precio (€/ud.)
VS0531323	A	43	40	80	100	11,30
VS0531325	A	56	50	88,5	50	13,79
VS0531326	B	60	50	90	50	16,58
VS0531327	C	70	75	53	30	16,58
VS0531333	A	125	110	300	10	19,86
VS0531335	A	140	110	420	5	34,37
VS0531337	A	150	125	420	5	36,47

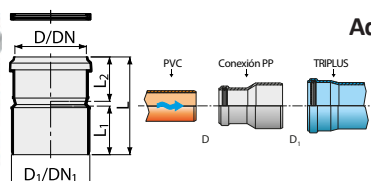

Adaptador en PP, boca hembra con junta unión PVC - macho unión PP/PP3 Phono

Referencia	D/D1 (mm)	DN/DN1 (mm)	L (mm)	L1 (mm)	L2 (mm)		Precio (€/ud.)
VS0565001	100/110	100/100	138	69	63	20	9,47

Adaptadores entre distintos sistemas

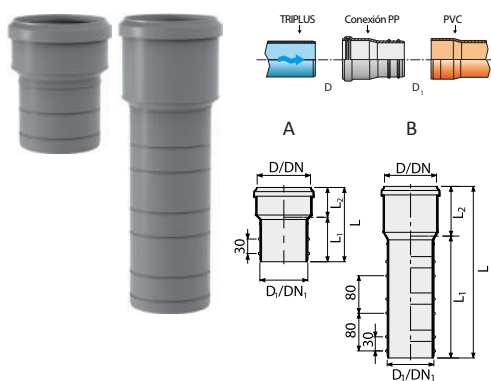

Adaptador en PP, boca hembra con junta unión PP/PP3 Phono - macho con junta unión PVC

Referencia	Mod.	D/D ₁ (mm)	DN/DN ₁ (mm)	L (mm)	L ₁ (mm)	L ₂ (mm)		Precio (€/ud.)
VS0564001	A	110/100	100/100	156	95	60	20	9,73
VS0564003	B	110/100	100/100	367	265	100	15	10,73

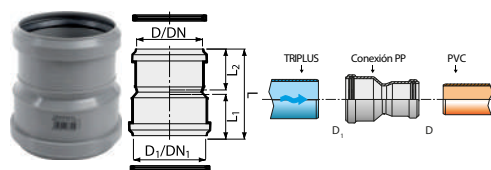

Adaptador en PP, doble boca hembra para unión PVC - PP/PP3 Phono

Referencia	D/D ₁ (mm)	DN/DN ₁ (mm)	L (mm)	L ₁ (mm)	L ₂ (mm)		Precio (€/ud.)
VS0565022	100/110	100/100	134	63	63	20	10,22

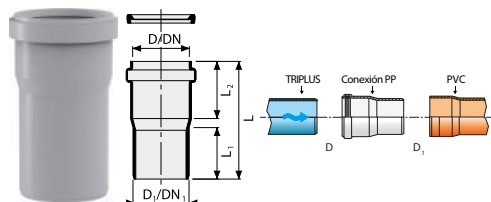

Adaptador en PP, boca hembra con junta unión PP/PP3 Phono - macho para encolar PVC

Referencia	D/D ₁ (mm)	DN/DN ₁ (mm)	L (mm)	L ₁ (mm)	L ₂ (mm)		Precio (€/ud.)
VS0564121	40/40	40/40	105	50	55	40	5,31
VS0564123	50/50	50/50	105	50	55	30	5,45
VS0564150	50/100	50/100	130	91	40	10	12,65
VS0564075	75/75	70/70	144	87	58	15	11,44
VS0564131	75/80	70/80	154	78	75	15	11,44
VS0564182	75/82	70/80	159	78	80	15	11,44
VS0564175	75/100	70/100	156	77	77	10	12,65
VS0564190	90/100	90/100	143	76	65	10	12,71
VS0564101	110/100	100/100	147	83	57	10	13,55
VS0564251	110/125	100/125	145	83	60	10	12,60

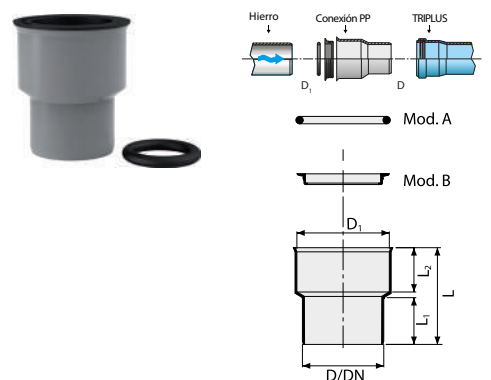

Adaptador en PP, boca hembra con doble sellado (anillo y junta tórica) unión HIERRO - macho unión PP/PP3 Phono

Referencia	D/D ₁ (mm)	DN (mm)	L (mm)	L ₁ (mm)	L ₂ (mm)		Precio (€/ud.)
VS0569001	50/72	50	115	50,9	55	20	5,08
VS0569003	75/92	70	115	50,5	55,6	20	6,19
VS0569005	110/124	100	130	64,6	58,4	20	9,69
VS0569007	125/151	125	145,5	71,9	65	10	30,59

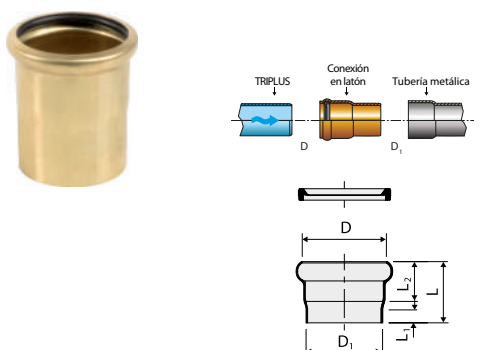

Adaptador de latón, boca hembra con junta unión PP/PP3 Phono - macho unión Tubería metálica

Referencia	D (mm)	D ₁ (mm)	L (mm)	L ₁ (mm)	L ₂ (mm)		Precio (€/ud.)
VS0570001	32	32	61	26	33	40	7,71
VS0570002	40	32	59	28	25	40	7,71
VS0570003	40	40	55	25	25	40	7,71
VS0570005	50	50	-	-	-	40	8,76

Adaptadores entre distintos sistemas

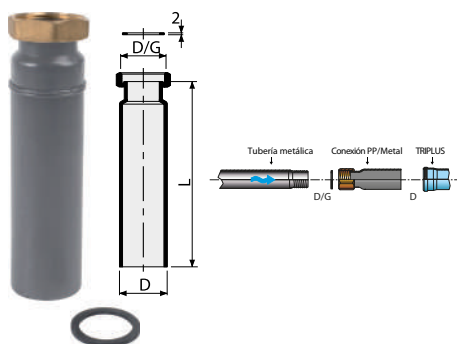

Adaptador prolongador en PP, adaptador rosca hembra unión Tubería metálica o plástica - macho unión PP/PP3 Phono

Referencia	D/G (")	D (mm)	Rosca	L		Precio (€/ud.)
VS0700052	G 1 1/4"	40	Latón	195	20	20,99
VS0700064	G 1 1/2"	40	Latón	195	20	22,28
VS0700252	G 1 1/4"	40	Plástico	195	20	19,10
VS0700264	G 1 1/2"	40	Plástico	195	20	19,51
VS0700267	G 1 1/4"	50	Plástico	195	20	22,28

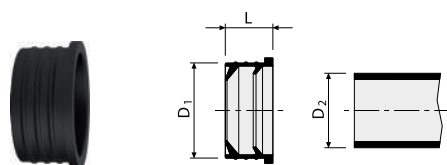

Adaptador elastomérico polivalente para conexión con otros sistemas

Referencia	D1 PP (mm)	D2 Metal (mm)	L (mm)		Precio (€/ud.)
VS0559001	40	26-28	24	50	2,35
VS0559003	40	30-32	25	50	2,35



 **SILERE**



Sistema en PP
con carga mineral.
Máximo confort
acústico

Sistema de tuberías y accesorios de polipropileno monocapa con carga mineral para evacuación insonorizada

El sistema **SILERE** se compone de la tubería y los accesorios en polipropileno monocapa con carga mineral para evacuación de aguas residuales y pluviales por gravedad a baja y alta temperatura. Máximo nivel de insonorización.



Características

- Máximas prestaciones acústicas. Certificado Fraunhofer nivel de fonoabsorbencia 6 dB(A) con caudal de descarga 2 l/s según EN 14366.
- Producto libre de halógenos.
- Sistema de unión por junta elastomérica monolabial.

Aplicaciones

- Evacuación de aguas residuales en el interior del edificio hasta 95 °C.
- Ventilación primaria, secundaria y terciaria.
- Aspiraciones centralizadas.
- Ventilación de gases de chimeneas.
- Sistemas gravitatorios industriales.
- Evacuación de condensados de circuitos de climatización.

La instalación

Sistema de unión mediante boca con junta elastomérica monolabial

El sistema **SILERE** garantiza una instalación rápida y sin el uso de adhesivos, equipos eléctricos o maquinaria especial gracias al sistema de unión con junta labial.



Sistema de unión mediante manguito corredizo

El sistema **SILERE** dispone del manguito corredizo, el acoplamiento idóneo que permite la unión de dos tubos. Este sistema permite la recuperación de tubos, modificación de instalación y la realización de reparaciones.

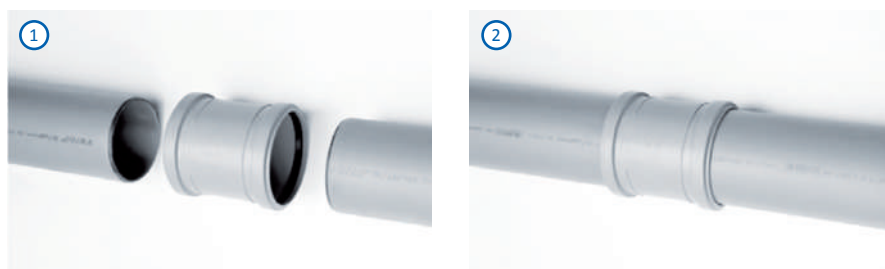

Tuberías en polipropileno monocapa con carga mineral evacuación insonorizada

Tubo con 1 boca

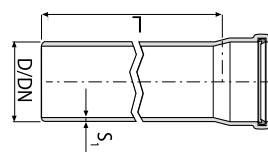

Referencia	D (mm)	DN (mm)	Espesor S1 (mm)	L (mm)		Precio (€/ud.)
VS0220007	58	50	4,0	1000	16	23,14
VS0220009	58	50	4,0	2000	16	41,21
VS0220011	58	50	4,0	3000	16	59,24
VS0220027	78	70	4,5	1000	16	24,38
VS0220029	78	70	4,5	2000	16	43,26
VS0220031	78	70	4,5	3000	16	62,11
VS0220047	90	90	4,5	1000	12	25,44
VS0220049	90	90	4,5	2000	12	49,97
VS0220050	90	90	4,5	3000	12	73,54
VS0220053	110	100	5,4	250	4	12,76
VS0220055	110	100	5,4	500	4	19,42
VS0220057	110	100	5,4	1000	15	31,90
VS0220059	110	100	5,4	2000	15	57,15
VS0220061	110	100	5,4	3000	15	83,49
VS0220077	135	125	5,6	1000	8	45,84
VS0220081	135	125	5,6	3000	8	114,29
VS0220097	160	150	5,6	1000	8	57,73
VS0220101	160	150	5,6	3000	8	154,22

Referencias de tubo disponibles en stock, para otros largos de tubo consultar en atencionalcliente@italsan.com o en el 900 921 957

Accesorios en polipropileno monocapa con carga mineral evacuación insonorizada

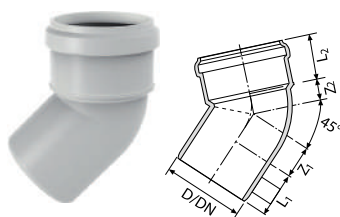

Codo 45°

Referencia	D (mm)	DN (mm)	Z1 (mm)	L1 (mm)	Z2 (mm)	L2 (mm)		Precio (€/ud.)
VS0221005	58	50	28	70	17	55	4	13,54
VS0221015	78	70	37	60	21	60	4	14,14
VS0221025	90	90	22	60	20	60	4	18,05
VS0221035	110	100	44	61	28	65	4	19,63
VS0221045	135	125	50	64	34	70	4	29,16
VS0221055	160	150	30	66	42	70	4	39,18

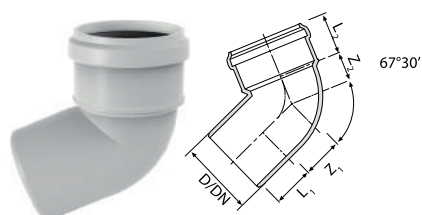

Codo 67° 30'

Referencia	D (mm)	DN (mm)	Z1 (mm)	L1 (mm)	Z2 (mm)	L2 (mm)		Precio (€/ud.)
VS0221007	58	50	32	70	21	50	4	12,73
VS0221017	78	70	26	60	26	70	4	13,36
VS0221037	110	100	44	61	44	100	4	18,40

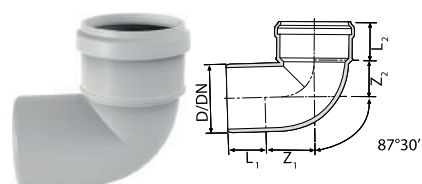

Codo 87° 30'

Referencia	D (mm)	DN (mm)	Z1 (mm)	L1 (mm)	Z2 (mm)	L2 (mm)		Precio (€/ud.)
VS0221009	58	50	47	70	32	55	4	14,49
VS0221019	78	70	62	60	42	60	4	14,49
VS0221029	90	90	49	60	42	60	4	19,20
VS0221039	110	100	78	61	58	65	4	20,59
VS0221049	135	125	96	64	102	70	4	33,24
VS0221059	160	150	83	66	89	70	4	46,85

Accesorios en polipropileno monocapa con carga mineral evacuación insonorizada

Derivación 45°

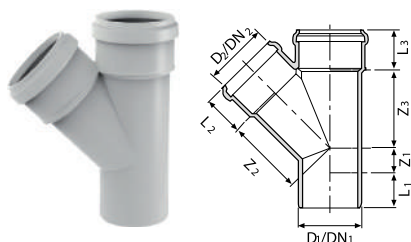

Referencia	D ₁ /D ₂ (mm)	DN ₁ /DN ₂ (mm)	Z ₁ (mm)	L ₁ (mm)	Z ₂ (mm)	L ₂ (mm)	Z ₃ (mm)	L ₃ (mm)		Precio (€/ud.)
VS0222005	58/58	50/50	12	70	75	55	75	55	4	24,44
VS0222009	78/78	70/70	16	60	99	60	99	60	4	26,43
VS0222011	90/58	80/50	19	60	113	60	113	55	4	31,14
VS0222013	90/90	90/90	19	60	116	60	113	60	4	26,16
VS0222015	110/58	100/50	1	61	110	65	97	55	4	30,34
VS0222017	110/78	100/70	21	61	122	65	115	60	4	33,14
VS0222018	110/90	100/80	44	61	168	60	136	70	4	36,16
VS0222019	110/110	100/100	44	61	136	70	136	70	4	37,68
VS0222021	135/110	125/100	49	64	169	70	169	65	2	54,99
VS0222023	135/135	125/125	49	64	169	70	169	70	2	68,45
VS0222025	160/110	150/100	36	95	180	70	200	70	2	74,11
VS0222027	160/160	150/150	36	95	200	70	200	70	2	96,21

Derivación 67° 30'

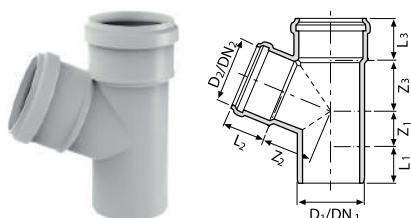

Referencia	D ₁ /D ₂ (mm)	DN ₁ /DN ₂ (mm)	Z ₁ (mm)	L ₁ (mm)	Z ₂ (mm)	L ₂ (mm)	Z ₃ (mm)	L ₃ (mm)		Precio (€/ud.)
VS0223015	110/58	100/50	11	61	75	65	65	55	4	27,41
VS0223019	110/110	100/100	58	61	84	70	84	70	4	33,43

Derivación 87° 30'

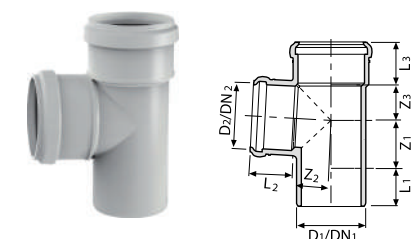

Referencia	D ₁ /D ₂ (mm)	DN ₁ /DN ₂ (mm)	Z ₁ (mm)	L ₁ (mm)	Z ₂ (mm)	L ₂ (mm)	Z ₃ (mm)	L ₃ (mm)		Precio (€/ud.)
VS0224005	58/58	50/50	28	70	32	55	32	55	4	25,76
VS0224009	78/78	70/70	37	60	43	60	43	60	4	26,43
VS0224015	110/58	100/50	47	61	61	65	27	55	4	30,42
VS0224017	110/78	100/70	60	61	61	65	43	55	4	33,08
VS0224019	110/110	100/100	78	61	58	70	58	70	4	37,68
VS0224021	135/110	125/100	90	64	72	70	72	65	2	54,99
VS0224023	135/135	125/125	90	64	72	70	72	70	2	69,08

Accesorios en polipropileno monocapa con carga mineral evacuación insonorizada

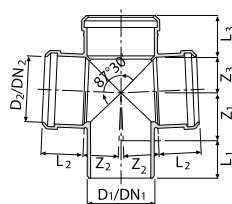

Derivación doble 87° 30'

Referencia	D ₁ /D ₂ (mm)	DN ₁ /DN ₂ (mm)	Z ₁ (mm)	L ₁ (mm)	Z ₂ (mm)	L ₂ (mm)	Z ₃ (mm)	L ₃ (mm)		Precio (€/ud.)
VS0225011 *	110/110	100/100	78	61	58	70	58	70	2	92,85
VS0225013 *	135/110	125/100	80	84	74	71	72	70	2	128,01

(*) Derivación manipulada

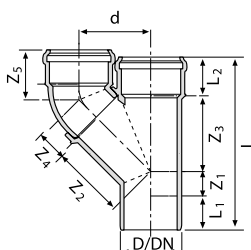

Derivación paralela

Referencia	D (mm)	DN	Z ₁ (mm)	Z ₂ (mm)	Z ₃ (mm)	Z ₄ (mm)	Z ₅ (mm)	D (mm)	L ₁ (mm)	L (mm)		Precio (€/ud.)
VS0233011	110	100	100	100	100	100	100	100	100	100	2	132,56

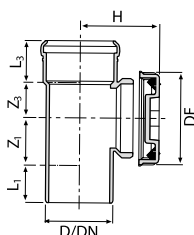

Inspección con tapón roscado

Referencia	D (mm)	DN	Z ₁ (mm)	L ₁ (mm)	Z ₃ (mm)	L ₃ (mm)	H (mm)	DE (mm)		Precio (€/ud.)
VS0227005	58	50	28	70	32	55	72	90	4	30,95
VS0227007	78	70	37	60	43	60	82	120	4	33,81
VS0227011	110	100	78	61	58	70	110	150	4	47,66
VS0227013	135	125	90	64	72	65	115	150	4	99,02
VS0227015	160	150	80	95	80	70	120	150	2	125,35

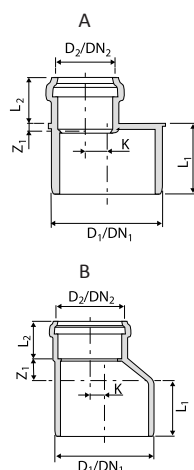

Reducción excéntrica

Referencia	Mod.	D ₁ /D ₂ (mm)	DN ₁ /DN ₂ (mm)	K (mm)	Z ₁ (mm)	L ₁ (mm)	L ₂ (mm)		Precio (€/ud.)
VS0226005	A	78/58	70/50	5	10	60	55	4	9,71
VS0226007	A	90/58	90/50	11	10	67	55	4	13,71
VS0226009	A	90/78	90/70	0	15	67	60	4	14,34
VS0226011	A	110/58	100/50	22	10	70	55	4	12,57
VS0226013	A	110/78	100/70	11	10	70	60	4	12,73
VS0226015	A	110/90	100/90	5	10	70	60	4	16,46
VS0226017	B	135/110	125/100	7	15	85	65	4	20,96
VS0226019	B	160/110	150/100	23	35	90	65	4	27,77
VS0226021	B	160/135	150/125	10	32	90	70	4	31,14

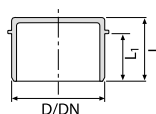

Tapón

Referencia	D (mm)	DN (mm)	L ₁ (mm)	L (mm)		Precio (€/ud.)
VS0230005	58	50	50	65	4	6,84
VS0230007	78	70	51	66	4	9,87
VS0230009	90	90	51	66	4	12,30
VS0230011	110	100	56	72	4	14,73
VS0230013	135	125	60	77	4	21,54
VS0230015	160	150	45	63,5	4	27,77

Accesorios en polipropileno monocapa con carga mineral evacuación insonorizada

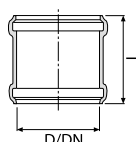

Manguito deslizante

Referencia	D (mm)	DN (mm)	L (mm)		Precio (€/ud.)
VS0228005	58	50	105	4	8,66
VS0228007	78	70	107	4	8,93
VS0228011	110	100	117	4	11,94
VS0228013	135	125	126	4	19,63
VS0228015	160	150	147	4	23,87

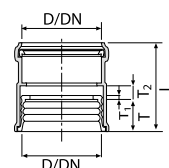

Manguito unido doble boca

Referencia	D (mm)	DN (mm)	T (mm)	T ₁ (mm)	T ₂ (mm)	L (mm)		Precio (€/ud.)
VS0229005	58	50	48	5	15	119	4	5,96
VS0229009	90	90	47	6	16	124	4	7,12
VS0229011	110	100	48	6	16	124	4	7,51

Adaptadores entre distintos sistemas

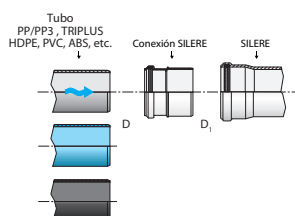

Adaptador SILERE, boca hembra con junta unión polivalente - macho unión SILERE

Referencia	D ₁ /D ₂ (mm)	DN ₁ /DN ₂ (mm)	Z ₁ (mm)	L (mm)	L ₁ (mm)		Precio (€/ud.)
VS0231001	58/40	50/40	30	67	50	4	9,00
VS0231003	58/50	50/50	25	86	60	4	9,09
VS0231005	78/50	70/50	37	80	60	4	9,30
VS0231007	78/75	70/70	0	116	60	4	9,30
VS0231013	135/125	125/125	0	138	72,5	2	14,22

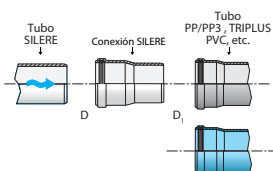

Adaptador SILERE, boca hembra unión SILERE - macho unión polivalente

Referencia	D ₁ /D ₂ (mm)	DN ₁ /DN ₂ (mm)	Z ₁ (mm)	L (mm)	S ₁ (mm)		Precio (€/ud.)
VS0237003	58/50	50/50	145	60	2,5	4	24,45
VS0237007	78/75	70/70	150	70	3,5	4	24,84
VS0237013	135/125	125/125	190	75	3,5	2	65,78



BOTES SIFÓNICOS PP



Sifones y
botes sifónicos PP

Sifón colector en línea

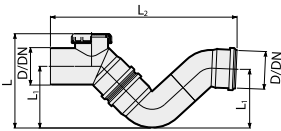

Sifón Colector en línea Macho/Hembra con registro

Referencia	D (mm)	DN (mm)	L (mm)	L1 (mm)	L2 (mm)		Precio (€/ud.)
VS0533050	50	50	165	110	380	1	34,38
VS0533075	75	70	215	135	420	1	41,94
VS0533110	110	100	280	180	535	1	58,93
VS0533125	125	125	310	200	610	1	104,50
VS0533160	160	150	350	250	700	1	198,87

Botes sifónicos PP

Sifón para plato de ducha extraplano

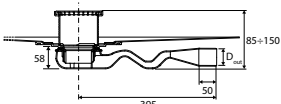
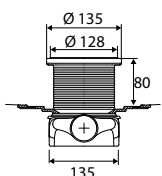
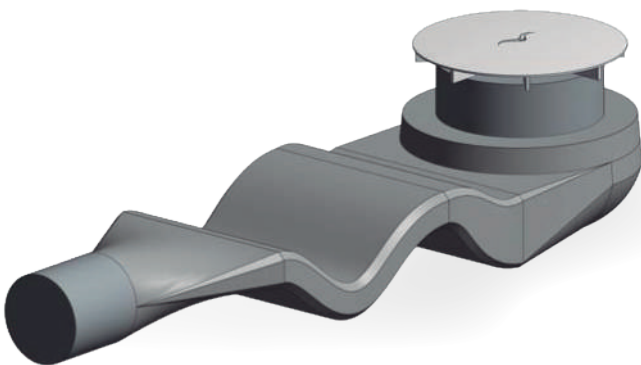

Sifón para plato de ducha extraplano T-58

Referencia	Dout (mm)	Conexión		Precio (€/ud.)
VS0700388	50	Horizontal	1	Consultar

Sifones y botes sifónicos en polipropileno

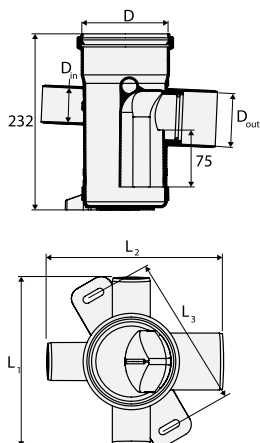

Bote sifónico TRIPLUS inspeccionable

Referencia	D (mm)	D _{in} (mm)	D _{out} (mm)	L ₁ /L ₂ /L ₃ (mm)		Precio (€/ud.)
VS0701741	110	3 x 50	1 x 75	220/230/200	5	59,26

- Bote sifónico Triplus formado por tres entradas de Ø 50mm y una salida de 75mm. Las entradas son ciegas a efectos de ser perforadas en función de las necesidades.
- Incluye sello hidráulico. Altura de sello hidráulico de 75 mm.
- Conexiones directas con bocas hembra mediante junta elástica.
- Se incluye el sistema de soportación inferior que lo hace 360º orientable y ajustable a la altura respecto a forjado.

COMPLEMENTOS BOTE SIFÓNICO TRIPLUS INSPECCIONABLE

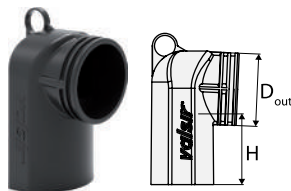

Sello hidráulico para bote TRIPLUS

Referencia	D _{out} (mm)	H (mm)		Precio (€/ud.)
VS0701702	75	75	1	8,15

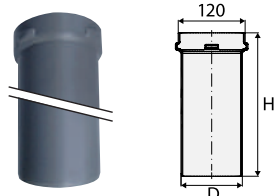

Prolongador en PP de 500 mm y 150 mm

Referencia	D (mm)	H (mm)		Precio (€/ud.)
VS0701031	110	500	10	9,90
VS0701032	110	150	10	7,54

Compatibles directamente con bote sifónico TRIPLUS ref. VS0701741 sin necesidad de junta.

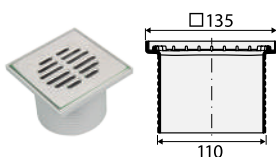

Prolongador completo con rejilla cuadrada 135 x 135 en acero inoxidable

Referencia	Dimensiones (mm)		Precio (€/ud.)
VS0701660	135 x 135	1	19,38

Compatible directamente con bote sifónico TRIPLUS ref. VS0701741 sin necesidad de junta.

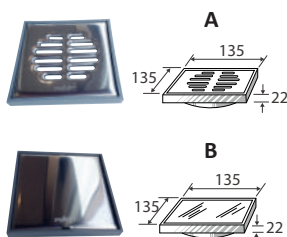

Tapa cuadrada inox, modelo rejilla y modelo ciega.

Referencia	Tipo	Dimensiones (mm)	Grosor tapa (mm)		Precio (€/ud.)
VS0701205	A	135 x 135	22	15	12,78
VS0701207	B	135 x 135	22	15	12,78

Compatibles con prolongador ref. VS0701031 y VS0701032.

No compatible directamente en bote sifónico TRIPLUS ref. VS0701741.

Sifones y botes sifónicos en polipropileno

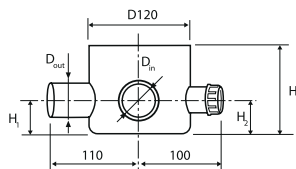

Bote sifónico en polipropileno inspeccionable

Referencia	D Salida (mm)	D Entrada (mm)	H (mm)	H1 (mm)	H2 (mm)		Precio (€/ud.)
VS0701011	50	4x40	100	40	40	10	12,22
VS0701015	50	4x40	145	40	40	10	12,78

- Bote sifónico formado por cuatro entradas de Ø 40 mm y una salida de 50 mm.
- El bote incluye una tapa protectora superior, 2 tapas ciegas, 4 tuercas y 4 juntas cónicas para las conexiones de entrada.
- No incluye tapón con válvula para sello hidráulico ref. VS0701301.
- No admite conexión a prolongador.

COMPLEMENTOS BOTE SIFÓNICO REF. VS0701011 Y VS0701015

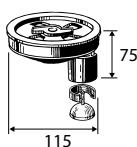

Tapón completo con válvula para sello hidráulico

Referencia	H (mm)		Precio (€/ud.)
VS0701301	75	10	8,38

Compatible con botes sifónicos ref. VS0701011 y ref. VS0701015.

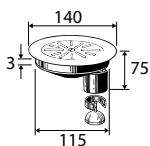

Tapón completo con válvula para sello hidráulico + Rejilla redonda acero inox

Referencia	D (mm)	H (mm)		Precio (€/ud.)
VS0701201	115	75	10	13,96

Compatible con botes sifónicos ref. VS0701011 y ref. VS0701015.

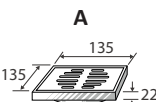

Tapa cuadrada inox, modelo rejilla y modelo ciega.

Referencia	Tipo	Dimensiones (mm)	Grosor tapa (mm)		Precio (€/ud.)
VS0701205	A	135 x 135	22	15	12,78
VS0701207	B	135 x 135	22	15	12,78

Compatibles con botes sifónicos ref. VS0701011 y ref. VS0701015.

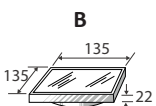

RECAMBIOS



Tuerca

Referencia	Ø (mm)		Precio (€/ud.)
VS0701021	40	10	0,74



Válvula antiespumante

Referencia		Precio (€/ud.)
VS0703045	10	6,41



Tapón

Referencia	Ø (mm)		Precio (€/ud.)
VS0701023	40	10	1,03



Terminal cierre válvula

Referencia		Precio (€/ud.)
VS0701305	10	13,96



Junta cónica

Referencia	Ø (mm)		Precio (€/ud.)
VS0701025	40	10	0,28

Sifones y botes sifónicos en polipropileno



Bote sifónico en polipropileno inspeccionable

Referencia	D Salida (mm)	D Entrada (mm)	H (mm)	H1 (mm)	H2 (mm)		Precio (€/ud.)
VS0701050	50	4x40	125	75	75	10	14,88
VS0701075	75	4x40	125	75	75	10	17,46

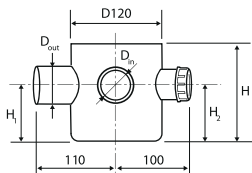

- Bote sifónico formado por cuatro entradas de \varnothing 40mm y una salida de 50mm o 75mm.
- El bote incluye una tapa protectora superior, 2 tapas ciegas, 4 tuercas y 4 juntas cónicas para las conexiones de entrada.
- Las referencias VS0701050 y VS0701075 incluyen sello hidráulico extraíble con junta tórica (ref. sello hidráulico: VS0701150 y VS0701175, ref. juntas tóricas del sello hidráulico: VS0701350 y VS0701019).
- La conexión al prolongador es opcional y siempre mediante la junta ref. VS0701033.

COMPLEMENTOS BOTE SIFÓNICO REF. VS0701050 Y VS0701075



Sello hidráulico

Referencia	Dout (mm)		Precio (€/ud.)
VS0701150	50	10	1,63
VS0701175	75	15	2,59

Compatible con botes sifónicos ref. VS0701050 y VS0701075.

Junta tórica para sello hidráulico ref. VS0701150 y VS0701175

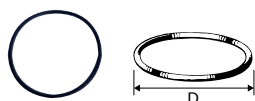

Referencia	D (mm)		Precio (€/ud.)
VS0701350	50	10	0,28
VS0701019	75	10	0,47

Compatible con botes sifónicos ref. VS0701050 y VS0701075.

Prolongador en PP

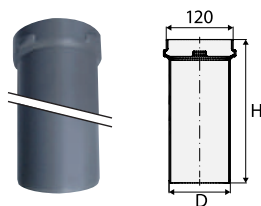

Referencia	D (mm)	H (mm)		Precio (€/ud.)
VS0701031	110	500	10	9,90
VS0701032	110	150	10	7,54

Compatibles con botes sifónicos ref. VS0701050 y VS0701075 mediante la junta ref. VS0701033.

Junta para prolongador



Referencia	D (mm)		Precio (€/ud.)
VS0701033	110	100	2,77

Compatible con botes sifónicos ref. VS0701050 y VS0701075.

Tapón completo



Referencia	D (mm)	Altura tapón (mm)		Precio (€/ud.)
VS0701303	115	33	15	6,41

Compatible con botes sifónicos ref. VS0701050 y VS0701075.

Sifones y botes sifónicos en polipropileno

COMPLEMENTOS BOTE SIFÓNICO REF. VS0701050 Y VS0701075

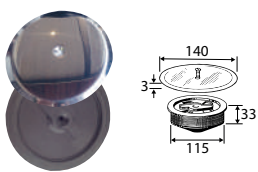

Tapón completo + Tapa ciega redonda acero inox

Referencia	D (mm)	H (mm)		Precio (€/ud.)
VS0701203	115	33	10	12,48

Compatible con botes sifónicos ref. VS0701050 y VS0701075.

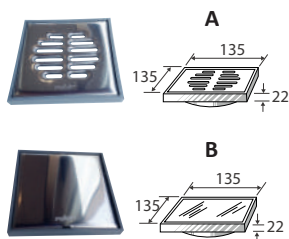

Tapa cuadrada inox, modelo rejilla y modelo ciega.

Referencia	Tipo	Dimensiones (mm)	Grosor tapa (mm)		Precio (€/ud.)
VS0701205	A	135 x 135	22	15	12,78
VS0701207	B	135 x 135	22	15	12,78

Compatibles directamente con botes sifónicos ref. VS0701050 y VS0701075.

Compatibles directamente con prolongador con ref. VS0701050 y VS0701075.

RECAMBIOS



Tuerca

Referencia	∅ (mm)		Precio (€/ud.)
VS0701021	40	10	0,74



Junta cónica

Referencia	∅ (mm)		Precio (€/ud.)
VS0701025	40	10	0,28



Tapón

Referencia	∅ (mm)		Precio (€/ud.)
VS0701023	40	10	1,03



 **PPECOFORTE**

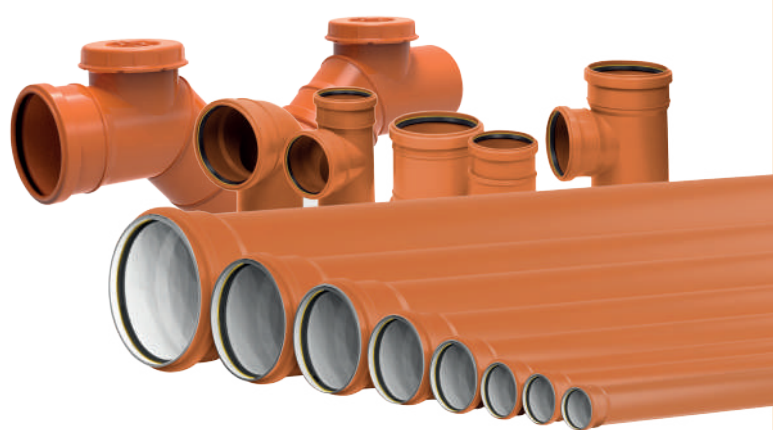

Sistema de
evacuación en
PP-HM.
Evacuación y
saneamiento
enterrado

Tubos PP-HM

Tubo con 1 boca

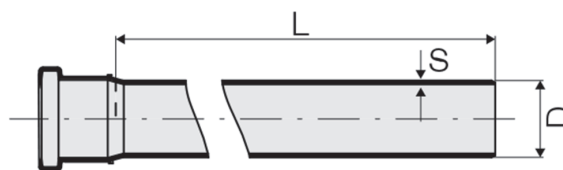

Referencia	Ø (mm)	S (mm)	L (mm)		Precio (€/ud.)
TUBO 1 BOCA SN4					
VSE010003	110	3,4	3000	30	56,88
VSE010013	125	3,9	3000	36	88,05
VSE010023	160	4,9	3000	14	121,10
VSE010033	200	6,2	3000	10	205,51
VSE010043	250	7,7	3000	8	333,95
VSE010053	315	7,7	3000	6	430,58
TUBO 1 BOCA SN8					
VSE010153	315	10,6	3000	6	539,45
VSE010163	400	13,5	3000	2	847,70
VSE010173	500	16,8	3000	2	1.302,74
TUBO 1 BOCA SN12					
VSE010253	315	11,6	3000	4	568,82
VSE010263	400	15,0	3000	2	910,08
VSE010273	500	18,6	3000	2	1.370,64
TUBO 1 BOCA SN16					
VSE010353	315	13,5	3000	4	638,54
VSE010363	400	16,9	3000	2	998,16
VSE010373	500	21,4	3000	2	1.570,63

Accesorios PP-HM

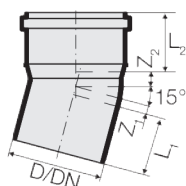

Curva 15°

Referencia	Ø (mm)	DN (mm)	Z1 (mm)	L1 (mm)	Z2 (mm)	L2 (mm)		Precio (€/ud.)
VSE010401	110	100	9	61	16	59	20	10,61
VSE010402	125	125	10	66	17	64	20	16,26
VSE010403	160	150	12	45	22	73	1	25,01
VSE010404	200	200	15	100	23	87	1	89,05
VSE010405	250	250	19	140	34	152	1	248,30
VSE010406	315	300	73	171	76	171	1	390,09
VSE010407	400	400	52	198	138	198	1	608,89
VSE010408	500	500	55	232	151	232	1	989,46

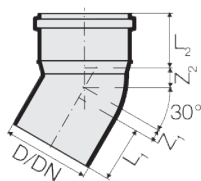

Curva 30°

Referencia	Ø (mm)	DN (mm)	Z1 (mm)	L1 (mm)	Z2 (mm)	L2 (mm)		Precio (€/ud.)
VSE010421	110	100	17	61	23	59	20	10,61
VSE010422	125	125	18	66	26	64	20	16,26
VSE010423	160	150	23	75	33	73	1	25,01
VSE010424	200	200	38	100	46	87	1	89,05
VSE010425	250	250	42	140	51	152	1	248,30
VSE010426	315	300	98	171	97	171	1	390,09
VSE010427	400	400	80	198	166	198	1	608,89
VSE010428	500	500	89	232	185	232	1	989,46

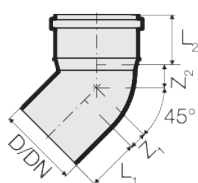

Curva 45°

Referencia	Ø (mm)	DN (mm)	Z1 (mm)	L1 (mm)	Z2 (mm)	L2 (mm)		Precio (€/ud.)
VSE010441	110	100	25	61	31	59	20	11,65
VSE010442	125	125	28	66	35	64	15	17,47
VSE010443	160	150	35	75	45	73	1	32,88
VSE010444	200	200	63	180	86	170	1	74,50
VSE010445	250	250	57	210	88	203	1	137,00
VSE010446	315	300	117	171	120	171	1	513,75
VSE010447	400	400	109	198	195	198	1	723,06
VSE010448	500	500	126	232	222	232	1	1.008,50

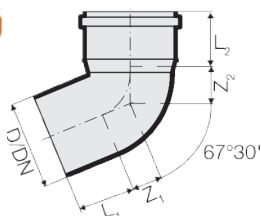

Curva 67°30'

Referencia	Ø (mm)	DN (mm)	Z1 (mm)	L1 (mm)	Z2 (mm)	L2 (mm)		Precio (€/ud.)
VSE010461	110	100	40	61	45	59	20	11,65
VSE010462	125	125	43	66	51	64	15	17,47

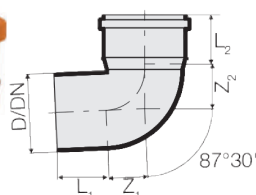

Curva 87°

Referencia	Ø (mm)	DN (mm)	Z1 (mm)	L1 (mm)	Z2 (mm)	L2 (mm)		Precio (€/ud.)
VSE010481	110	100	57	61	61	59	20	13,71
VSE010482	125	125	62	66	70	64	10	22,60
VSE010483	160	150	78	75	89	73	1	38,36
VSE010484	200	200	148	180	172	170	1	74,50
VSE010485	250	250	122	210	163	203	1	137,00
VSE010486	315	300	234	171	240	171	1	532,79
VSE010487	400	400	278	198	364	198	1	761,11
VSE010488	500	500	322	232	418	232	1	1.065,58

Accesorios PP-HM

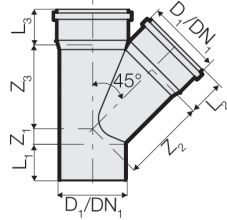

Derivación 45°

Referencia	D1/DN1 (mm)	Z1 (mm)	L1 (mm)	Z2 (mm)	L2 (mm)	Z3 (mm)	L3 (mm)		Precio (€/ud.)
VSE010501	110/110	25	61	135	59	135	59	10	25,69
VSE010502	125/125	28	66	152	65	152	65	5	34,26
VSE010503	160/160	36	75	198	73	199	73	1	58,24
VSE010504	200/200	66	132	278	132	302	132	1	453,83
VSE010505	250/250	100	160	370	160	344	160	1	582,26
VSE010506	315/315	130	171	434	171	449	171	1	804,89
VSE010507	400/400	213	198	552	170	590	198	1	1.236,82
VSE010508	500/500	150	232	718	232	718	232	1	2.625,88

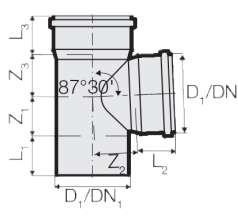

Derivación 87°

Referencia	D1/DN1 (mm)	Z1 (mm)	L1 (mm)	Z2 (mm)	L2 (mm)	Z3 (mm)	L3 (mm)		Precio (€/ud.)
VSE010521	110/110	56	61	65	59	65	59	10	25,69
VSE010522	125/125	65	66	71	65	71	65	10	34,26
VSE010523	160/160	80	75	94	73	97	73	1	58,24
VSE010524	200/200	160	132	150	132	139	132	1	453,83
VSE010525	250/250	175	160	185	160	165	160	1	582,26
VSE010526	315/315	359	171	234	171	220	171	1	804,89
VSE010527	400/400	296	198	300	170	257	198	1	1.236,82
VSE010528	500/500	530	232	378	232	338	232	1	2.625,88

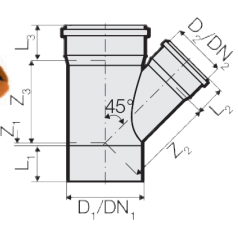

Derivación reducida 45°

Referencia	D1/D2 (mm)	DN1/DN2 (mm)	Z1 (mm)	L1 (mm)	Z2 (mm)	L2 (mm)	Z3 (mm)	L3 (mm)		Precio (€/ud.)
VSE010601	125/110	125/100	18	66	146	59	142	65	8	26,53
VSE010602	160/110	150/100	6	75	185	59	171	73	1	42,81
VSE010603	200/110	200/100	49	132	222	63	254	132	1	231,18
VSE010604	250/110	250/100	6	160	257	63	279	160	1	316,83
VSE010605	315/110	300/100	-3	171	303	63	360	171	1	445,26
VSE010607	160/125	150/125	12	75	184	65	174	73	1	51,38
VSE010608	200/125	200/125	49	132	240	68	254	132	1	231,18
VSE010609	250/125	250/125	6	160	275	68	279	160	1	316,83
VSE010610	315/125	300/125	-3	171	321	68	360	171	1	462,38
VSE010612	200/160	200/150	114	132	270	91	254	132	1	265,44
VSE010613	250/160	250/150	61	160	320	91	279	160	1	359,63
VSE010614	315/160	300/150	-2	171	349	91	360	171	1	479,52
VSE010616	250/200	250/200	69	160	320	132	344	160	1	402,44
VSE010617	315/200	300/200	26	171	355	132	449	171	1	522,32
VSE010619	315/250	300/250	130	171	395	160	449	171	1	685,02
VSE010615	400/160	400/150	-52	198	409	91	400	198	1	685,02
VSE010624	400/200	400/200	87	198	435	132	472	198	1	1.255,86
VSE010618	400/250	400/250	80	198	450	160	472	198	1	723,06
VSE010625	400/315	400/300	213	198	509	171	590	198	1	1.293,90
VSE010620	500/160	500/150	8	232	479	91	510	232	1	875,28
VSE010626	500/200	500/200	8	232	508	132	510	232	1	1.408,07
VSE010621	500/250	500/250	8	232	528	160	510	232	1	1.027,51
VSE010627	500/315	500/300	220	232	577	171	648	232	1	1.484,20
VSE010628	500/400	500/400	220	232	632	198	648	232	1	1.750,60

Sistema ECOFORTE

Accesorios PP-HM

Derivación reducida 87°

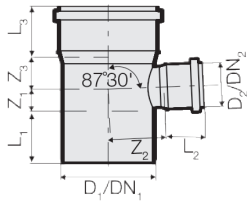

Referencia	D1/D2 (mm)	DN1/DN2 (mm)	Z1 (mm)	L1 (mm)	Z2 (mm)	L2 (mm)	Z3 (mm)	L3 (mm)		Precio (€/ud.)
VSE010641	125/110	125/100	58	66	72	59	64	65	8	26,53
VSE010642	160/110	150/100	55	75	93	59	71	73	1	42,81
VSE010643	200/110	200/100	136	132	137	63	125	132	1	231,18
VSE010644	250/110	250/100	118	160	162	63	165	160	1	316,83
VSE010645	315/110	300/100	126	171	201	63	180	171	1	445,26
VSE010647	160/125	150/125	64	75	93	65	79	73	1	51,38
VSE010648	200/125	200/125	136	132	137	68	125	132	1	231,18
VSE010649	250/125	250/125	118	160	162	68	165	160	1	316,83
VSE010650	315/125	300/125	126	171	200	68	180	171	1	462,38
VSE010652	200/160	200/150	136	132	145	91	125	132	1	265,44
VSE010653	250/160	250/150	175	160	162	91	165	160	1	359,63
VSE010654	315/160	300/150	126	171	200	91	180	171	1	479,52
VSE010656	250/200	250/200	175	160	177	132	165	160	1	402,44
VSE010657	315/200	300/200	126	171	210	132	180	171	1	522,32
VSE010659	315/250	300/250	359	171	215	160	220	171	1	685,02
VSE010655	400/160	400/150	171	198	245	91	177	198	1	685,02
VSE010664	400/200	400/200	171	198	236	132	177	198	1	1.255,86
VSE010658	400/250	400/250	171	198	240	160	177	198	1	723,06
VSE010665	400/315	400/300	296	198	280	171	257	198	1	1.293,90
VSE010660	500/160	500/150	141	232	289	91	178	232	1	875,28
VSE010666	500/200	500/200	141	232	288	132	178	232	1	1.408,07
VSE010661	500/250	500/250	141	232	290	160	178	232	1	1.027,51
VSE010667	500/315	500/300	260	232	299	171	258	232	1	1.484,20
VSE010668	500/400	500/400	530	232	352	198	338	232	1	1.750,60

Inspección

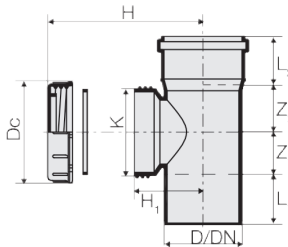

Referencia	D/DN (mm)	Z1 (mm)	L1 (mm)	Z2 (mm)	L2 (mm)	H (mm)	Dc (mm)	K (mm)	H1 (mm)		Precio (€/ud.)
VSE010901	110/110	55	61	65	59	100	120	105	90	15	30,83
VSE010902	125/125	65	66	71	65	105	150	128	98	10	42,81
VSE010903	160/160	64	75	75	73	105	150	128	118	1	68,51
VSE010904	200/200	154	132	148	132	184	150	128	142	1	273,99
VSE010905	250/250	126	160	120	160	209	150	128	158	1	376,75
VSE010906	315/315	115	171	109	171	242	150	128	225	1	513,75
VSE010907	400/400	107	198	101	198	284	150	128	266	1	608,89
VSE010908	500/500	94	232	103	232	334	150	128	316	1	1.103,63

Reducción excéntrica

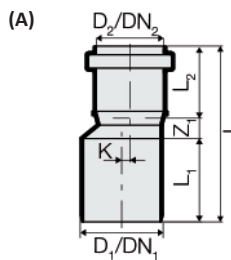

Referencia	D1/D2 (mm)	DN1/DN2 (mm)	Mod.	K (mm)	Z1 (mm)	L1 (mm)	L2 (mm)	L (mm)		Precio (€/ud.)
VSE010921	125/110	125/100	A	4	6	67	49	122	20	12,82
VSE010922	160/110	150/100	B	10	-	63	52	81	1	16,79
VSE010923	160/125	150/125	B	4	-	64	56	83	1	21,40
VSE010924	200/125	200/125	A	22	53	117	57	227	1	111,31
VSE010925	200/160	200/150	A	18	45	93	77	215	1	154,12
VSE010926	250/200	250/200	A	23	51	124	135	310	1	179,81

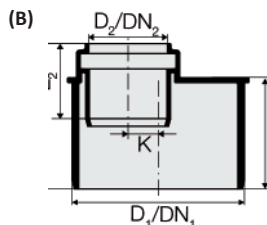

Accesorios PP-HM

Sifón colector en línea macho/hembra con 2 registros

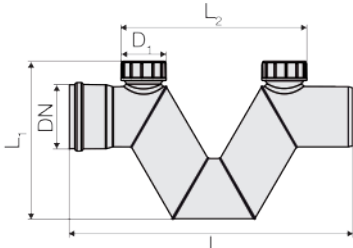

Referencia	D (mm)	L (mm)	L1 (mm)	L2 (mm)	D1 (mm)		Precio (€/ud.)
VSE010951	110	618	319	497	118	1	89,05
VSE010952	125	694	346	577	149	1	102,76
VSE010953	160	862	413	718	149	1	188,39
VSE010954	200	979	541	658	150	1	385,32
VSE010955	250	1128	638	712	150	1	1.096,01
VSE010956	315	1278	775	850	150	1	1.404,26

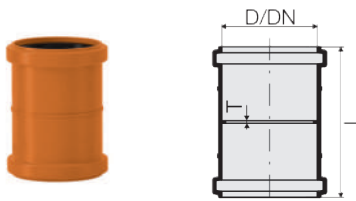

Manguito con tope

Referencia	D/DN (mm)	L (mm)	T (mm)		Precio (€/ud.)
VSE011001	110/100	136	3	20	11,99
VSE011002	125/125	147	3	20	17,99
VSE011003	160/150	180	3	1	29,11
VSE011004	200/200	220	4	1	51,38
VSE011005	250/250	290	4	1	119,88
VSE011006	315/300	385	-	1	580,36
VSE011007	400/400	492	-	1	1.046,54
VSE011008	500/500	575	-	1	1.674,47

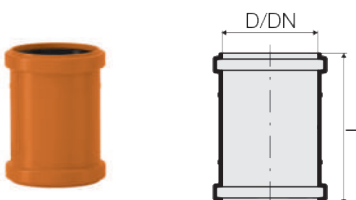

Manguito deslizante

Referencia	D/DN (mm)	L (mm)		Precio (€/ud.)
VSE011031	110/100	136	20	11,99
VSE011032	125/125	147	20	17,99
VSE011033	160/150	180	1	29,11
VSE011034	200/200	220	1	51,38
VSE011035	250/250	290	1	119,88



Tapón

Referencia	D (mm)	s (mm)	L (mm)		Precio (€/ud.)
VSE011201	110	3,2	38	20	4,30
VSE011202	125	3,2	42	10	8,05
VSE011203	160	4,0	49	10	8,57



Italsan Customer Service
atencionalcliente@italsan.com

www.italsan.com

Sede Madrid

Tel. (+34) 918 060 723

Oficinas y Almacén

Coto de Doñana, 21
28320 Pinto - Madrid

Sede Barcelona

Tel. (+34) 936 303 040

Italsantech

C/ de la Màquina, 8B
Pol. Ind. El Regàs
08850 Gavà - Barcelona

Sede Barcelona

Tel. (+34) 936 303 040

Centro logístico

C/ Progrés, 29
Pol. Ind. Les Massotes
08850 Gavà - Barcelona

ITALSAN no se responsabiliza de posibles errores que aparezcan en la presente tarifa, y se reserva el derecho de modificar sin previo aviso las características y precios* de los productos.

Para cualquier consulta dirigirse a atencionalcliente@italsan.com

*Precios sin IVA.

Distribuido por:

