

sanycces

mediterranean design



2022 COLLECTION

Bathtubs · Hot tubs · Shower trays

Bañeras · Spas · Platos de ducha

Baignoires · Spas · Receveurs

sanycces
bath concept

index

	p.
Mediterranean design	3
Sanycces	7
Product	
Bathtubs Bañeras Baignoires	15
Hot tubs Spas Spas	215
Shower trays Platos de ducha Receveurs	229
Displays Expositores Presentoirs	273
Materials	277
General info	289

Hay pocos sitios en los que podemos entrar y personalizar a través del equipamiento, materiales, colores y acabados. El hogar es un lugar seguro para expresar nuestra personalidad e identidad.

Concebimos el baño como un espacio donde detenernos para volver a conectarnos con nuestros orígenes, un espacio donde imprimir lo mejor de nuestra tierra...

There are few sites where we can enter and customize through the equipment, materials, colors and finishes. Home is a safe place to express our personality and identity.

We view the bathroom as a place to pause to reconnect with our origins, a place to print the best of our land...

Il y a peu d'endroits que nous pouvons personnaliser grâce à l'équipement, matériaux, couleurs et finitions. Le foyer est un lieu sûr qui permet d'exprimer notre personnalité et notre identité.

Nous concevons la salle de bain comme un lieu de connexion avec nos origines, un espace pour imprimer le meilleur de notre terre...



Mediterranean design



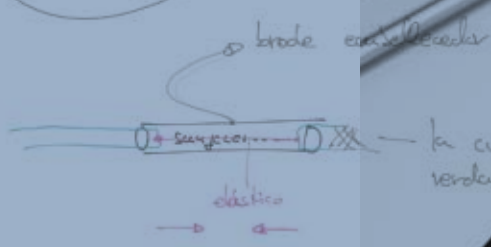
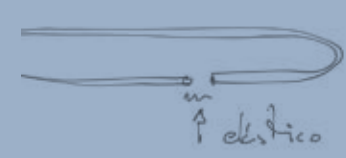
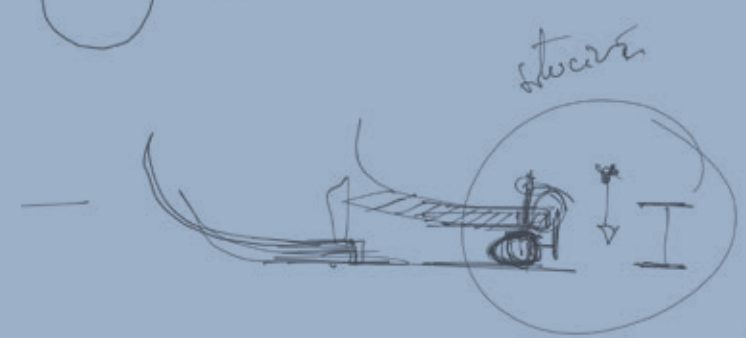
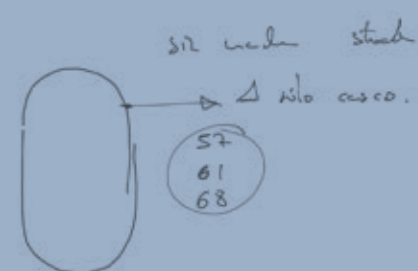
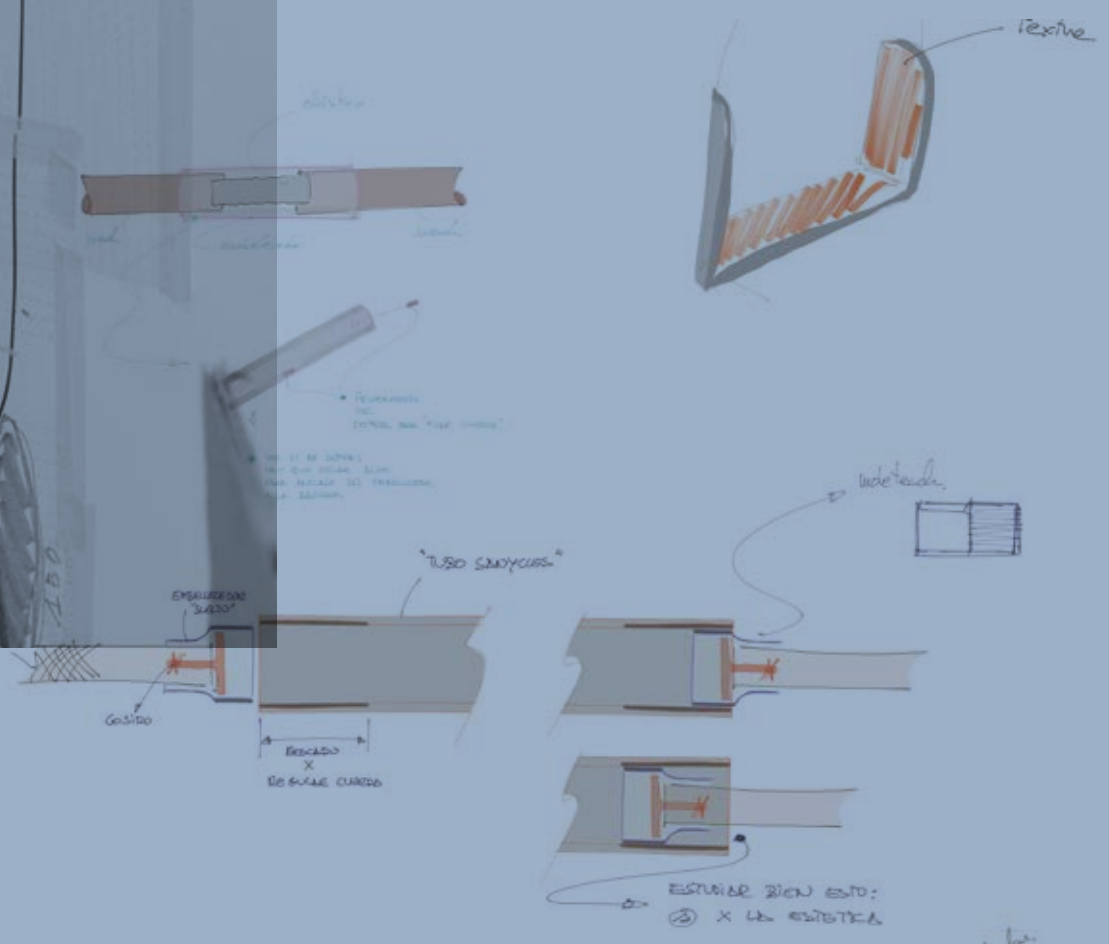

Sanycces es una empresa que diseña, fabrica y vende equipamiento para el baño cuidando aspectos estéticos, prácticos y de sostenibilidad.

Con la vista puesta en el futuro nuestro equipo de diseño interno se apoya en diseñadores emergentes y consolidados para idear nuevas soluciones para el baño.

Sanycces is a company that designs, manufactures and sells bathroom equipment with a focus on aesthetics, practicality and sustainability.

With an eye to the future, our in-house design team relies on emerging and established designers to come up with new solutions for the bathroom.

Sanycces est une entreprise qui conçoit, fabrique et vend des équipements de salle de bains en mettant l'accent sur l'esthétique, la praticité et la durabilité.

Tournée vers l'avenir, notre équipe de conception interne s'appuie sur des designers émergents ou confirmés pour proposer de nouvelles solutions pour la salle de bains.

jorge herrera studio.



Jorge Herrera

El diseñador Jorge Herrera siempre ha querido crear objetos y espacios sencillos y esenciales, de alta calidad y duraderos en cuanto a uso, producción y diseño.

Tras años de formación internacional y multidisciplinar, Jorge Herrera decide investigar más a fondo todas las áreas del proceso creativo y técnico del diseño abriendo su estudio en Valencia, España, en 2008. Y desde el principio sus trabajos abarcan desde el producto hasta el branding y el diseño de interiores.

The designer Jorge Herrera has always wanted to create objects and spaces that were simple and essential, high quality and long lasting in terms of use, production and design.

After years of international and multidisciplinary training, Jorge Herrera decides to further investigate all areas of the creative and technical process in design by opening his studio in Valencia, Spain, in 2008. And from the beginning his works range is from product to branding and interior designs.

Le designer Jorge Herrera a toujours voulu créer des objets et des espaces simples et essentiels, de haute qualité et durables en termes d'utilisation, de production et de design.

Après des années de formation internationale et multidisciplinaire, Jorge Herrera décide d'approfondir tous les domaines du processus créatif et technique du design en ouvrant son studio à Valence, en Espagne, en 2008. Dès le début, ses travaux vont du produit à l'image de marque en passant par la décoration intérieure.

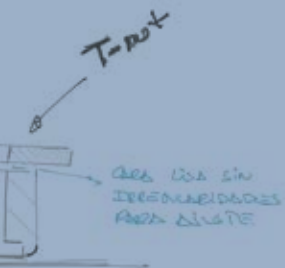

"Mi forma de trabajar y mi estilo se pueden resumir en pocas palabras: honesto, sencillo y funcional. Me gusta diseñar muebles, proyectos de iluminación y accesorios para el hogar que perduren en el tiempo, y que evoquen el sentido de la belleza en su sentido más puro y esencial"

En la actualidad, su enfoque del diseño se caracteriza por una clara búsqueda del equilibrio entre la sencillez, la funcionalidad y la belleza: los pilares de su estilo y el punto de apoyo de su trabajo. Cada uno de sus proyectos resalta la elegancia y la nobleza de los materiales -madera o cerámica, metal o nuevos materiales tecnológicos- realzando sus cualidades estilísticas y materiales.

"My way of working and my style can be summed up in a few words: honest, simple and functional. I like to design furniture, lighting projects and home accessories that last over time, and that evoke the sense of beauty in its purest and most essential sense"

Today his approach to design is characterized by a clear search for a balance between simplicity, functionality and beauty: the pillars of his style and the fulcrum of his work. Each of his projects highlights the elegance and nobility of the materials -wood or ceramic, metal or new technological materials -enhancing their stylistic and material qualities.

"Ma façon de travailler et mon style peuvent se résumer en quelques mots : honnête, simple et fonctionnel. J'aime concevoir des meubles, des projets d'éclairage et des accessoires de maison qui durent dans le temps et qui évoquent le sens de la beauté dans son sens le plus pur et le plus essentiel. "

Aujourd'hui, son approche du design se caractérise par une recherche claire d'un équilibre entre la simplicité, la fonctionnalité et la beauté : les piliers de son style et le point d'appui de son travail. Chacun de ses projets met en valeur l'élégance et la noblesse des matériaux - bois ou céramique, métal ou matériaux de nouvelle technologie - en valorisant leurs qualités stylistiques et matérielles.



sanycces

A growth history

Nuestra historia empieza en 1993 a orillas del mediterráneo, en una antigua papelería situada en el municipio de Burriana. Juan Gual y Esther Rosell acumulan en ese momento más de 32 años de experiencia comercial. Con la voluntad de transformar el baño y el entusiasmo de desarrollar un proyecto propio consiguen abrirse paso en el sector con una modesta producción consistente en una bañera de hidromasaje y una columna de ducha.

Son años intensos llenos de jornadas de trabajo interminables y viajes por todo el mundo, consecuencia de la apertura internacional de la empresa.

Con gran esfuerzo logramos democratizar un producto prohibitivo: la bañera de hidromasaje, consiguiendo que ésta llegue a un mayor número de usuarios. Gracias a este hito crecemos y nos diversificamos.

En 1999 el edificio de la papelería se nos queda pequeño y nos trasladamos a las afueras del municipio, rodeados de naranjos y pequeños talleres de la industria local.

La crisis económica de 2008 y su particular impacto en la construcción española nos fortalecen. El paradigma del consumo descontrolado se ha agotado y el consumidor se vuelve más exigente, y nuestra calidad y servicio se ven recompensados. Vivimos estos años con un crecimiento sin precedentes.

En 2009 nos trasladamos al Polígono industrial Carabona de Burriana, una nueva ubicación con vistas al mediterráneo y flanqueada, de nuevo, por naranjos.

Rejuvenecemos sin perder nuestro carácter: espíritu emprendedor, apertura internacional, calidad y servicio. Nos redefinimos para afrontar los nuevos retos, creamos la oficina de diseño para que nuestro producto cubra todas las expectativas de diseño e identidad propia.

Vivimos el presente momento de cambios sociales y políticos con una actitud responsable con el entorno, dinámica en el negocio e innovadora en el producto.

Our story begins in 1993 on the Mediterranean, in an old paper factory located in the municipality of Burriana. Juan Gual and Esther Rosell accumulate at that time over 32 years of business experience. With the will to transform the bathroom and enthusiasm to develop their own project, they find the way to establish themselves in the sector with a modest production consisting in a hydromassage bathtub and a shower panel.

There are full days and years of intense endless work and travels all around the world, due to the international opening of the company.

With great effort we democratize a prohibitively product: the hot tub, getting it to reach a larger number of users. Thanks to this milestone we grow and diversify.

In 1999 the building of the paper factory is too small and we move to the outskirts of the village, surrounded by orange groves and small workshops of the local industry.

The economic crisis of 2008 and its particular impact on the Spanish construction strengthen us. The uncontrolled consumption paradigm is exhausted and the consumer becomes more demanding, and our quality and service are rewarded. We live these years with unprecedented growth.

In 2009 we move to Carabona Industrial estate in Burriana, a new location overlooking the Mediterranean and flanked again by orange trees.

We rejuvenate without losing our character: entrepreneurship, international openness, quality and service. We redefine ourselves to meet new challenges, create the design office to cover all our product design expectations and identity.

We live this time of social and political change with an environment-responsible, business-dynamic and product-innovative attitude.

Tout commence en 1993 sur les rives de la Méditerranée, dans une ancienne entreprise de papier située dans la localité de Burriana. Juan Gual et Esther Rosell cumulent à ce moment plus de 32 ans d'expérience commerciale. Ce n'est que grâce à leur force de volonté et leur enthousiasme qu'ils s'ouvrent un passage dans le secteur du sanitaire avec une modeste production composée de baignoire hydromassage et d'une colonne de douche.

Commencent alors les années d'interminables journées de travail et les voyages autour du monde, conséquence de l'ouverture à l'internationale de l'entreprise

La démocratisation d'un produit jusque-là prohibitif comme la baignoire hydromassage nous a coûté de grands efforts mais nous avons réussi à la faire parvenir à un nombre croissants de foyers et grâce à ce tournant dans notre histoire nous avons pu croître et nous diversifier.

En 1999 le bâtiment de l'entreprise de papier s'est avéré trop petit et nous avons dû déménager à l'extérieur de la ville, nous entourant d'orangers et d'industriels locaux.

La crise économique de 2008 et en particulier son impact sur la construction espagnole nous a rendu encore plus forts, en effet paradoxalement, en s'achevant la consommation sans contrôle, le consommateur est devenu plus exigeant et c'est là où notre qualité et notre service se sont vus récompensés. Nous avons vécu ces années avec une croissance sans précédent.

En 2009, nous avons une nouvelle fois déménagé dans la Zone Industrielle de Carabona de Burriana, un nouveau lieu de travail avec vue sur la Méditerranée et entouré encore une fois d'orangers.

Nous rajeunissons sans pour autant perdre notre caractère: Esprit d'entreprise, ouverture à l'Internationale, qualité et service. Nous nous définissons pour affronter les nouveaux challenges, nous créons un bureau d'étude pour que notre produit puisse couvrir toutes les étapes d'élaboration et avoir une identité propre.

En pleins changements sociaux et politiques, nous gardons sur le moment présent une attitude responsable sur notre entourage, dynamique dans les affaires et innovante avec nos produits.

People friendly space

Con más de 21.300 m², nuestras instalaciones destacan por su contemporaneidad.

Un entorno espacioso, abierto al exterior y bien iluminado contribuye al trabajo en equipo y fomenta la creatividad y la generación de ideas.

Los divisores de cristal permiten el contacto visual entre el equipo de trabajo facilitando una comunicación fluida y espontánea.

With more than 21.300 m², our facilities stand out for their contemporaneity.

Spacious surroundings, opened to the outside and well lit contributes to teamwork and encourages creativity and ideas generation.

Glass dividers allow visual contact between the working team facilitating smooth and spontaneous communication.

Avec plus de 21.300 m², nos installations se dénotent par leur modernité

Un entourage spacieux, ouvert sur l'extérieur et bien illuminé contribue au travail en équipe et fomenta la créativité et la génération d'idées.

Les séparations en verre permettent le contact visuel entre les équipes de travail facilitant une communication fluide et spontanée.

- Offices
- Showroom
- Garden
- Production
- Logistic area
- Parking
- Loadings area





Passion for our work

Sanycces, es la suma de Sanyc (sanitario) y las siglas C.E.S.

C de Calidad. La gestión de la calidad vertebrada todo el ciclo de vida del producto, desde la extracción de materias primas hasta el servicio postventa.

E de Eficiencia. Nuestro producto nace en procesos de fabricación altamente industrializados y optimizados para reducir el consumo de energía y recursos. Gracias al toque artesano de los remates finales de cada pieza se logra un equilibrio entre la optimización productiva y la atención a los detalles.

S de Servicio. El stock de producto acabado y semielaborado de nuestro almacén digitalizado nos permite responder de forma inmediata a las demandas del mercado.

Sanycces, is the sum of Sanyc (for sanitary-health) and acronyms C.E.S.

C for Quality . The quality management involves the entire product life cycle, from extraction of raw materials to after-sales service.

E for Efficiency . Our product comes in highly industrialized and optimized processes to reduce energy consumption and manufacturing resources. Thanks to the artisan touch of the end caps of each piece a balance between productive optimization and attention to detail is achieved.

S for Service. The stock of finished and semi-elaborated products from our digitalized warehouse allows us to respond quickly to market demands.

Sanycces, c'est la Somme de Sanyc (sanitaire) et les sigles C.E.S.

C de calidad ou qualité en Français. La gestion de la qualité s'articule autour du produit pendant toute sa durée de vie, depuis l'extraction de la matière première jusqu'au service après-vente.

E d'Effacité. Notre produit résulte de procédés de fabrication hautement industrialisés et optimisés afin de réduire la consommation d'énergie et des ressources naturelles. Grâce à la touche artisanale des dernières finitions de chaque pièce, un équilibre est obtenu entre l'optimisation productrice et l'attention aux détails.

S de Service. Le stock de produits finis et semi-élabore de notre entrepôt digitalisé nous permet de répondre de façon immédiate aux demandes du marché.

« Para hacer las cosas bien es necesario: primero, el amor, segundo, la técnica. »

« To do the right thing is necessary: first, love, second, the technique. »

“Pour bien faire les choses il faut : d'abord l'amour et après la technique. », Antoni Gaudí





From Standard to custom made

Ser fabricantes nos da flexibilidad tanto para personalizar productos estándar como para hacer productos totalmente a diseñados ex profeso.

Being manufacturers gives us flexibility to customize both standard products to make products entirely designed on purpose.

Etre fabricants nous donne la flexibilité tant pour personnaliser des produits standards que pour créer des produits de design conçus spécialement.

1°

CATALOGUE

Nuestro producto estándar se configura en familias y series fácilmente combinables entre sí.

Our standard product is configured in families and easily combinable series.

Notre produit standard se décline en familles et séries facilement combinables entre elles.

2°

PERSONALIZATION

Hemos creado conceptos que permiten la personalización del producto estándar:

We have created concepts that allow customization of the standard product:

Nous avons créés des concepts qui permettent la personnalisation des produits standards:

sanysize sanycoat
sanygrip

3°

CUSTOM MADE

Productos diseñados y desarrollados bajo las especificaciones de un proyecto concreto.

Products designed and developed under the specifications of a particular project.

Produits conçus et développés selon les spécificités d'un projet concret.



Gracias a la empatía y la honestidad somos capaces de diseñar productos y espacios que cubran las necesidades de nuestros clientes. Compartimos ideas y puntos de vista con otros profesionales para alcanzar soluciones parciales o completamente desarrolladas para proyectos concretos.

With empathy and honesty we are able to design products and spaces that meet the needs of our customers. We share ideas and views with other professionals to achieve partial or fully developed solutions for specific projects.

Grâce à l'empathie et l'honnêteté, nous sommes capables de créer des produits et des espaces couvrant les besoins de nos clients. Nous partageons nos idées et points de vue avec d'autres professionnels afin d'atteindre des solutions partielles ou complètes pour des projets concrets.

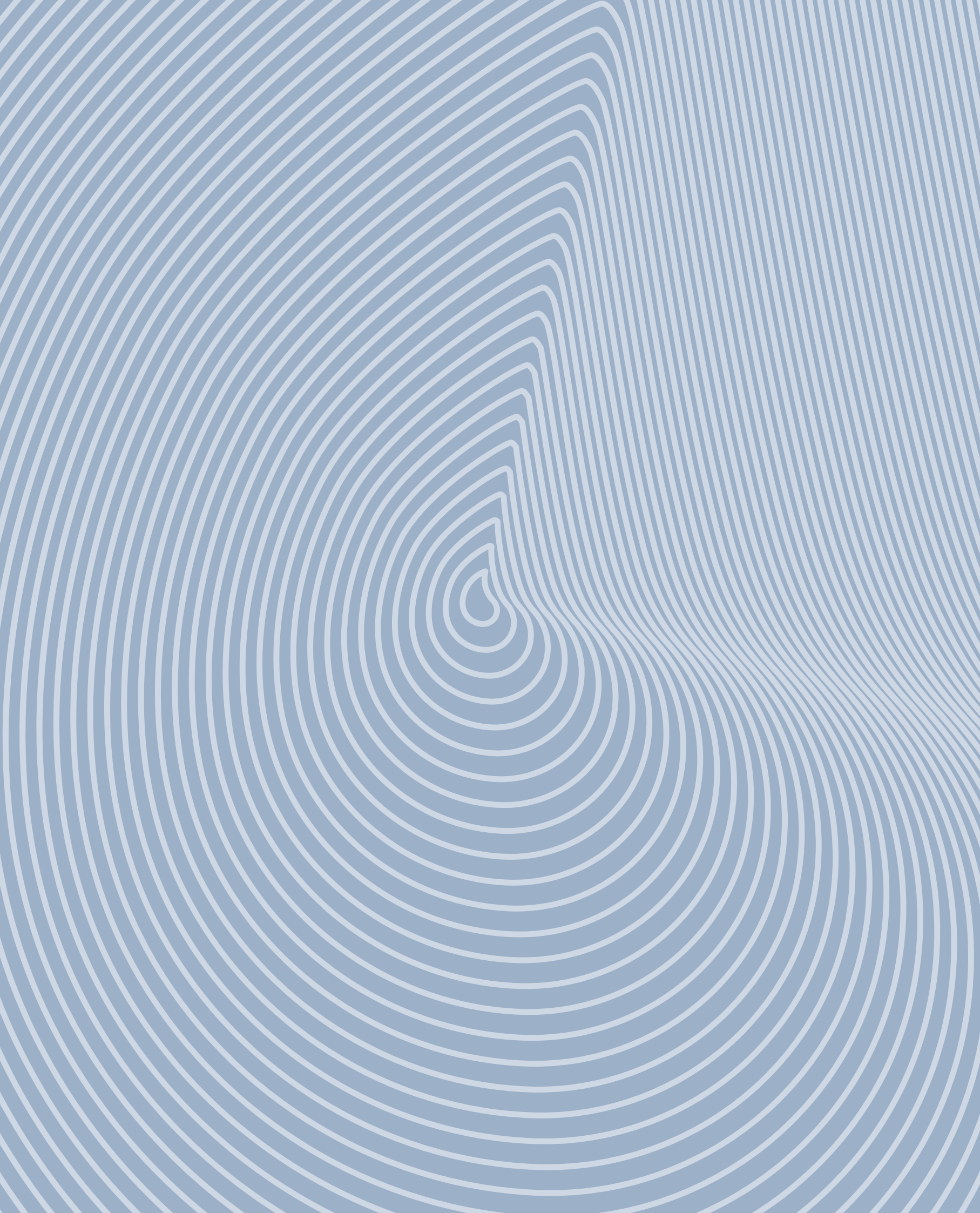

Bathtubs

Bañeras

Baignoires

Solid Sanycces®

Exento
Freestanding
En îlot

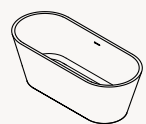

NCS
RAL

Modern
p. 22

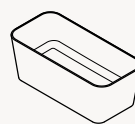

NCS
RAL

Rust
p. 28



NCS
RAL

Classic
p. 34

sanydur gel coat

Exento
Freestanding
En îlot



NCS
RAL

Rondo
p. 44

Bathtubs

Bañeras

Baignoires

sanitaryacrylic

Exento
Freestanding
En îlot



Tempo
p. 54

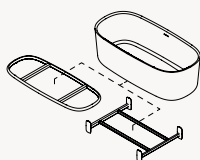

Calma
p. 72



Trento
p. 92



Dalia
p. 110



Torino
p. 116



A pared
To wall
Murale

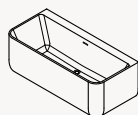

Trento Muro
p. 98

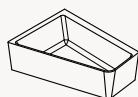

Trento Angolo
p. 104



Torino Muro
p. 120

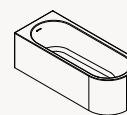

Torino Angolo
p. 124



Exenta y de encastre
Freestanding and built-in
En îlot et encastrable

De encastre
Built-in
Encastrable

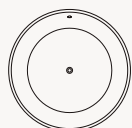

Noa
p. 130

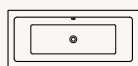

Cube
p. 146



Bali
p. 156

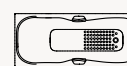

Project
p. 162

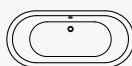

Loft
p. 138



Serena
p. 168

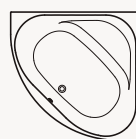

Brisa
p. 174

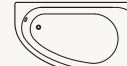

Tripoli
p. 180



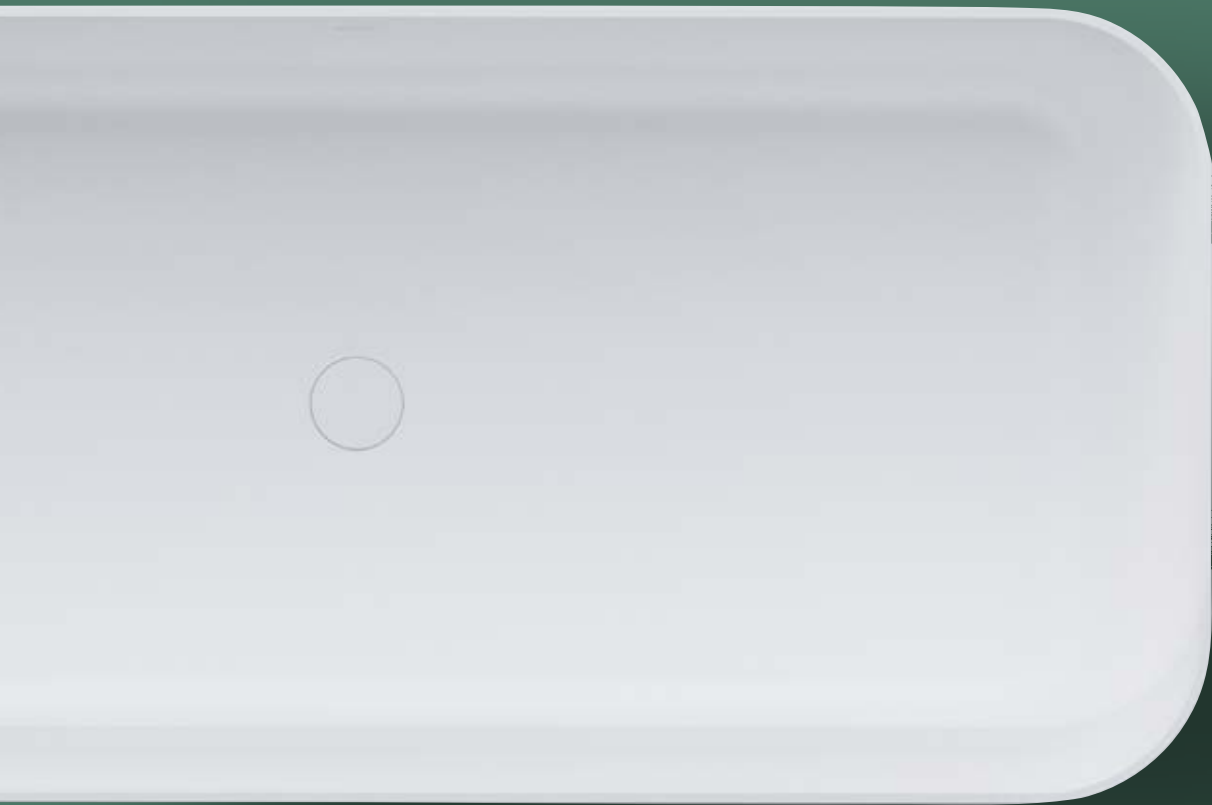

solid[®]
sanycces

solid[®]





Modern

solid®



Modern

Solid Sanycces®

170x80x64h



○ Blanco mate
Matt white
Blanc mate





Modern

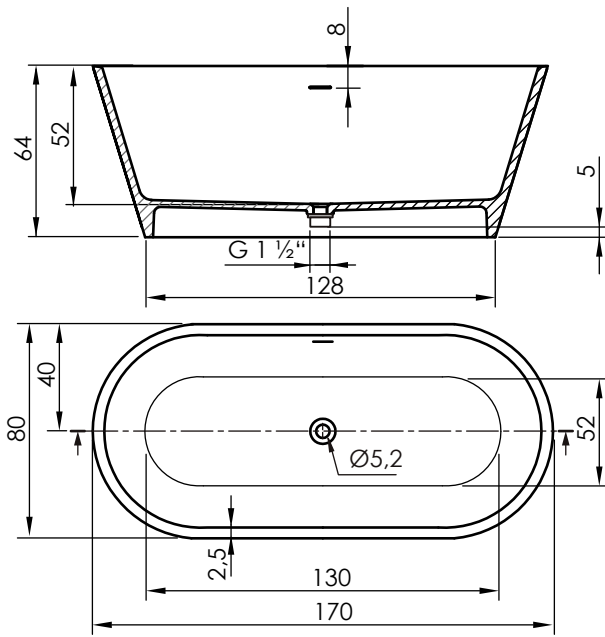

cm

CA

366 L

CA: Contenido agua / Water content / Contenu d'eau



Desagüe click-clack **Solid Sanycces®** incluido
Solid Sanycces® pop-up drain included
Bonde click-clack **Solid Sanycces®** incluse

Bañera / Bathtub / Baignoire

				 <p>Blanco mate Matt white Blanc mate</p>
		Modern 170x80		BNSS003
				3.190 €
		Modern 170x80 sanycoat	*	BNSS003RAL
				3.900 €

Opciones / Options / Options

	<p>Tratamiento antideslizante sanygrip Anti-slip treatment sanygrip Traitement antidérapant sanygrip</p>	SGBN002
		198 €

Opciones bañera p.191

* Especificar el RAL / NCS en el pedido.

Bathtub options p.191

* Specify the RAL / NCS in the order.

Options baignoires p.191

* Spécifiez le RAL / NCS dans la commande

Rust





Rust

Solid Sanycces®

150x70x55h



○ Blanco mate
Matt white
Blanc mate

+ Rust series



Lavabo
Washbasin
Vasque





 Rust +  BNEX001BG

Rust

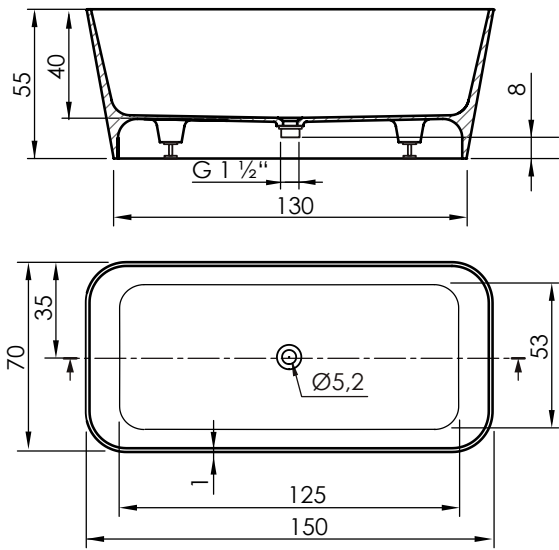

CA

266 L



CA: Contenido agua / Water content / Contenu d'eau

cm



Desagüe click-clack blanco incluido
White pop-up waste included
Bonde click-clack blanche incluse

Bañera / Bathtub / Baignoire

 		Rust 150x70		 Blanco mate Matt white Blanc mate	BNSS010	2.250 €
		Rust 150x70			BNSS010RAL	2.850 €
		sanycoat	*			

Opciones / Options / Options

	Tratamiento antideslizante sanygrip Anti-slip treatment sanygrip Traitement antidérapant sanygrip	SGBN002 198 €
--	--	------------------

Opciones bañera p.191
 * Especificar el RAL / NCS en el pedido.

Bathtub options p.191
 * Specify the RAL / NCS in the order.

Options baignoires p.191
 * Spécifiez le RAL / NCS dans la comande

Classic





Classic

Solid Sanycces®

180x88x57h



○ Blanco mate
Matt white
Blanc mate

+ Classic series



Lavabo
Washbasin
Vasque





 Classic

Classic

sanycoat

acabados especiales

special finishes

finitions spéciales



Classic sanycoat silver + Classic sanycoat silver



Classic sanycoat rust + Nira

Classic

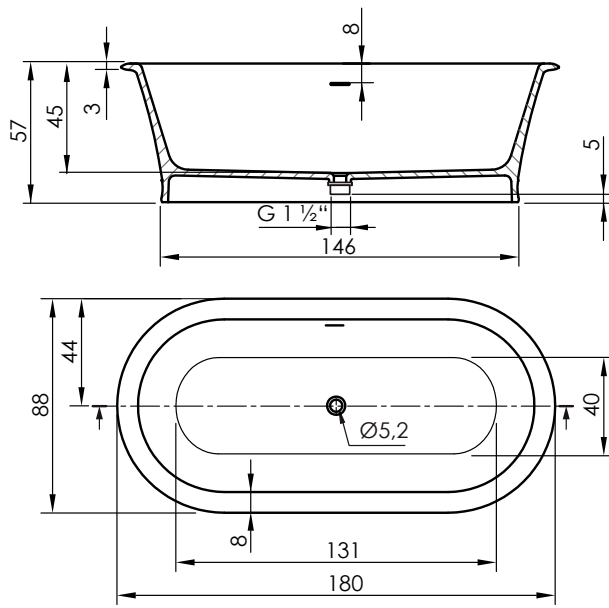

cm

CA

300 L

CA: Contenido agua / Water content / Contenu d'eau



Desagüe click-clack blanco incluido
White pop-up waste included
Bonde click-clack blanche incluse



sanycoat
gold













sanycoat
silver



sanycoat
rust

sanycoat
Acabado especial
Special finish
Finition spéciale

Bañera / Bathtub / Baignoire

					 Blanco mate Matt white Blanc mate		
			Classic 180x88			BNSS001	3.200 €
	sanycoat		Classic 180x88 sanycoat	*		BNSS001RAL	3.900 €
	Oro Gold Or		Classic 180x88 sanycoat special finish			BNSS001G	4.300 €
	Plata Silver Argent		Classic 180x88 sanycoat special finish			BNSS001S	4.300 €
	Óxido Rust Rouille		Classic 180x88 sanycoat special finish			BNSS001R	4.700 €

Opciones / Options / Options

	Tratamiento antideslizante sanygrip Anti-slip treatment sanygrip Traitement antidérapant sanygrip		SGBN002	198 €
---	---	--	---------	-------

Opciones bañera p.191

* Especificar el RAL / NCS en el pedido.

Bathtub options p.191

* Specify the RAL / NCS in the order.

Options baignoires p.191

* Spécifiez le RAL / NCS dans la commande



sanydur gel coat





Rondo



 Rondo matt 170

Rondo

sanydur gel coat

150x75x57h

170x80x60h



Blanco mate
Matt white
Blanc mate



Blanco brillo
Gloss white
Blanc brillat

+ Rondo series





Lavabo
Washbasin
Vasque



 Rondo 170 gloss

 Rondo 150 matt



 Rondo 170 matt +  BNE001MG

Rondo





 Rondo 170 gloss

Rondo

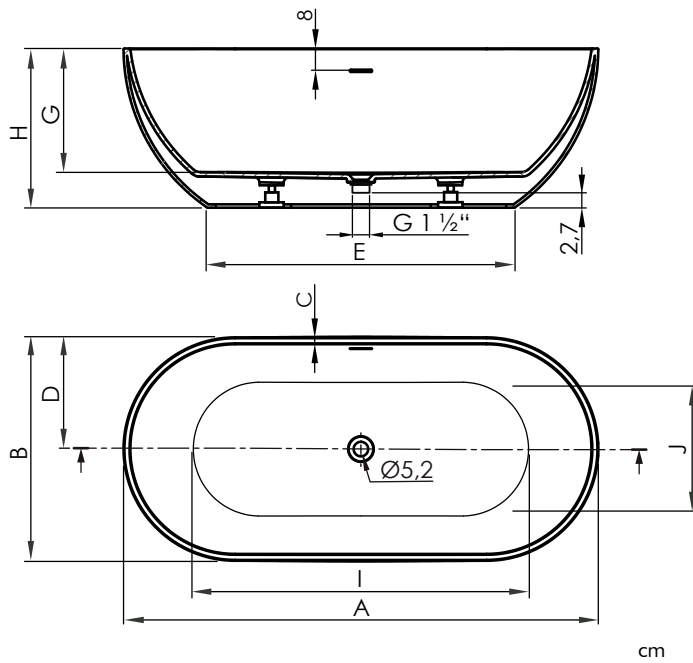



dim.cm	A	B	C	D	E	G	H	I	J	CA
150x75	150	75	2,4	37,5	95	45	57	105	44	239 L
170x80	170	80	2,4	40	110	48	60	117	44	314 L

CA: Contenido agua / Water content / Contenu d'eau



Desagüe click-clack Sanydur blanco incluido
 White Sanydur pop-up waste included
 Bonde click-clack Sanydur blanc incluse

Bañera / Bathtub / Baignoire

		Blanco mate Matt white Blanc mate		Blanco brillo Gloss white Blanc brillant	
 	 <p>Rondo 150x75</p>	BNFR00815075BM	2.350 €	BNFR00815075BB	2.400 €
	 <p>Rondo 150x75 sanycoat</p>	*	BNFR00815075BMRAL	2.950 €	BNFR00815075BBRAL
 	 <p>Rondo 170x80</p>	BNFR00817080BM	2.400 €	BNFR00817080BB	2.630 €
	 <p>Rondo 170x80 sanycoat</p>	*	BNFR00817080BMRAL	3.100 €	BNFR00817080BBRAL

Opciones / Options / Options

 <p>Tratamiento antideslizante sanygrip Anti-slip treatment sanygrip Traitement antidérapant sanygrip</p>	<p>SGBN002</p> <p>198 €</p>
---	-----------------------------

Opciones bañera p.191

* Especificar el RAL / NCS en el pedido.

Bathtub options p.191

* Specify the RAL / NCS in the order.

Options baignoires p.191

* Spécifiez le RAL / NCS dans la commande



sanitaryacrylic





Tempo



Tempo

sanitaryacrylic

170x75x60h



Blanco mate
Matt white
Blanc mate



Blanco brillo
Gloss white
Blanc brillant

Design by:

jorge herrera
studio.







Tempo

Design by:
jorge herrera
studio.





 Tempo matt Sanycoat half +  CUBN15203NB +  BABN001MA +  BNEX001NB

Tempo

Design by:
jorge herrera
studio.



Tempo matt Sanycoat half + CUBN15203NB + BNEX001NB



Tempo

Design by:
jorge herrera
studio.





 Tempo matt Sanycoat complete +  CUBN15202MG +  BNEX001MG

Tempo

Design by:
jorge herrera
studio.





 Tempo gloss +  CUBN15201RG +  BABN002MA +  BNEX001RG

Tempo

Customise your bathroom

Personaliza tu baño

Personnalisez votre salle de bains



Cuerda de altas prestaciones resistente a la humedad disponible en tres colores. Compuesta por un 70% de Poliéster y un 30% de algodón.

Cierre de latón disponible en seis acabados a combinar con la cuerda elegida.

High performance moisture resistant rope available in three colours. Made of 70% polyester and 30% cotton.

Brass clasp available in six finishes to match the chosen rope.

Corde haute performance résistant à l'humidité, disponible en trois couleurs. Composé de 70% de polyester et 30% de coton.

Fermeur en laiton disponible en six finitions pour s'harmoniser avec la corde choisie.



Tempo

Personalization on every detail...

Personalización en cada detalle...

Personnalisation sur chaque détail..

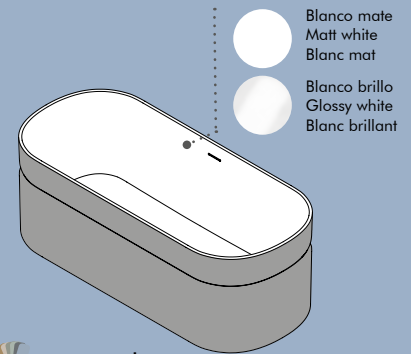
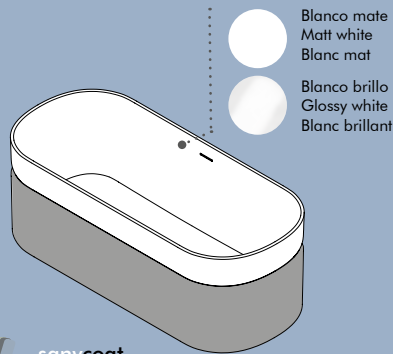
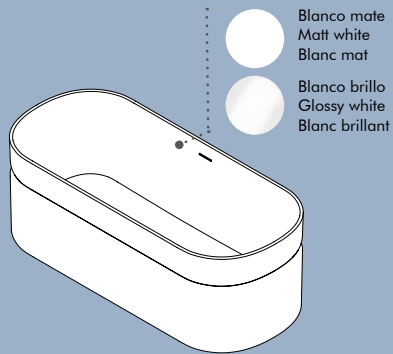

sanycoat
Lacada en color
Lacquered in color
Laqué de couleur

sanycoat
Lacada en color
Lacquered in color
Laqué de couleur

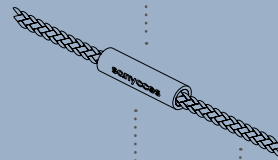

Broche cierre
Fastener clasp
Fermoir de fermeture

Cuerda
Rope
Corde

-  CR - Chrome
-  BM - Black Matt
-  MG Metal Gun
-  NB - Nickel Brushed
-  BG - Brushed Gold
-  RG - Brushed Rose Gold



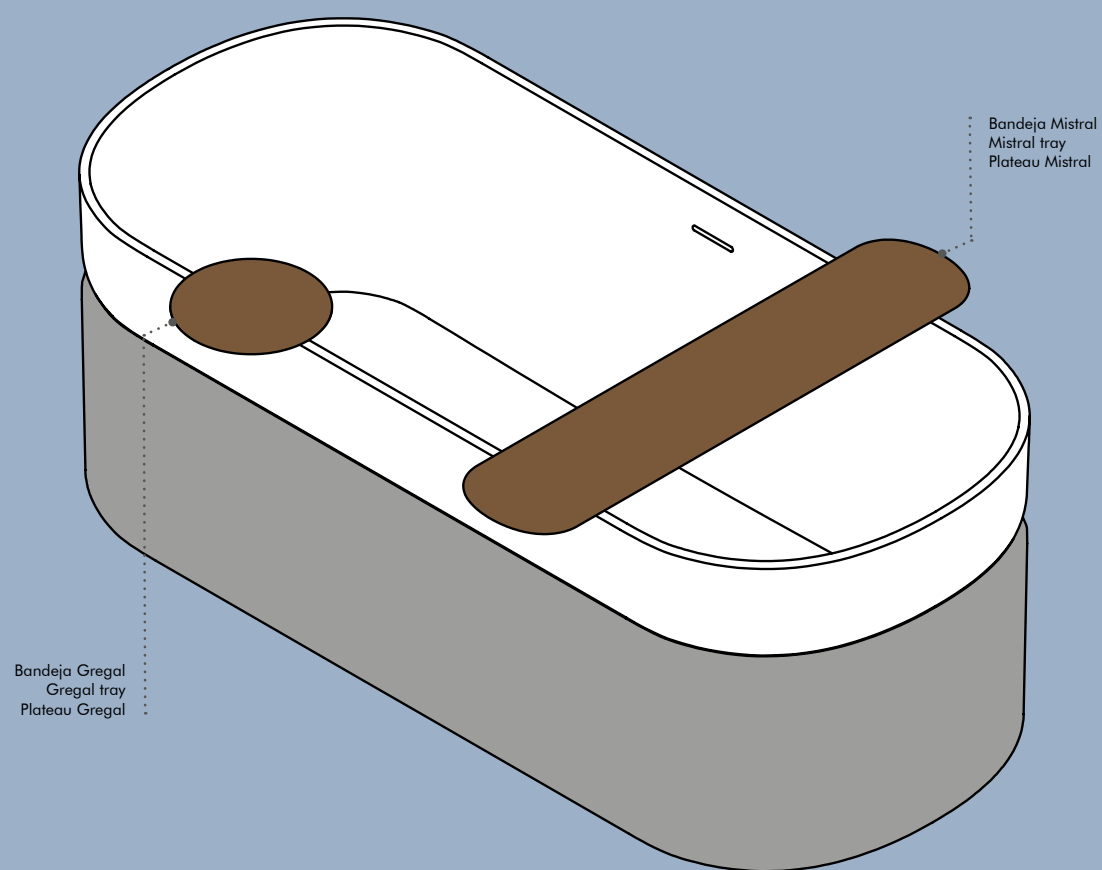

Tempo

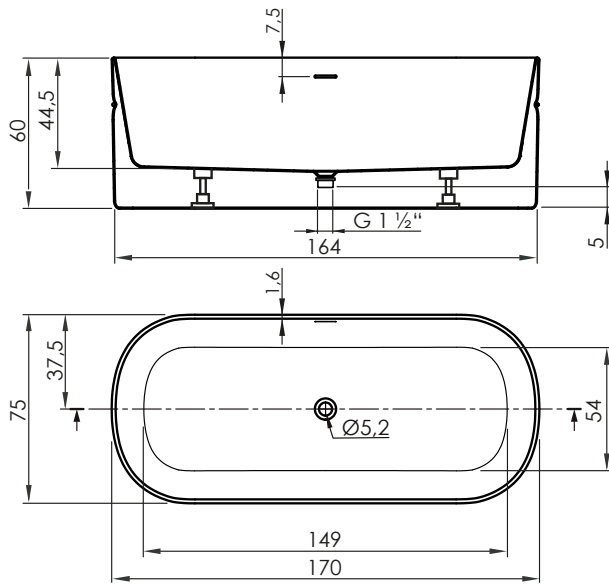

cm

CA





340 L

CA: Contenido agua / Water content / Contenu d'eau



Desagüe click-clack blanco incluido
White pop-up waste included
Bonde click-clack blanc incluse

Bañera / Bathtub / Baignoire



		Blanco mate / Matt white / Blanc mate	Blanco brillo / Gloss white / Blanc brillant
 sanycoat super- matt	 Tempo 170x75	BN15217575BM 2.550 €	BN15217575BB 2.400 €
	 Tempo 170x75 Sanycoat medio / half / moitié *	BN15217575BMMATME 3.150 €	BN15217575BBMATME 3.000 €
	 Tempo 170x75 Sanycoat completo / complete / complet *	BN15217575BMMATCO 3.250 €	BN15217575BBMATCO 3.100 €

sanitary acrylic

Opciones / Options / Options

Broche Fastener Fermeoir Cuerda Rope Cordon	CR	BM	MG	NB	BG	RG
	 Sand	CUBN15201CR 350 €	CUBN15201BM 350 €	CUBN15201MG 350 €	CUBN15201NB 350 €	CUBN15201BG 350 €
 Marengo	CUBN15202CR 350 €	CUBN15202BM 350 €	CUBN15202MG 350 €	CUBN15202NB 350 €	CUBN15202BG 350 €	CUBN15202RG 350 €
 Mix	CUBN15203CR 350 €	CUBN15203BM 350 €	CUBN15203MG 350 €	CUBN15203NB 350 €	CUBN15203BG 350 €	CUBN15203RG 350 €

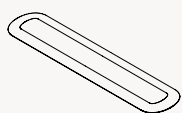
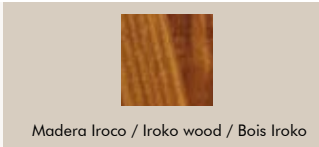
Accesorios / Accessories / Accessoires

 Mistral bandeja de bañera 86x20cm Mistral tray for freestanding bathtub 86x20cm Mistral plateau pour baignoire freestanding 86x20cm	 Madera Iroco / Iroko wood / Bois Iroko	BABN001MA 350 €
 Gregal bandeja portaobjetos Ø30 cm Gregal slide tray Ø30 cm Plateau à glissière Gregal Ø30 cm		BABN002MA 360 €

Opciones bañera p.191

* Especificar el RAL / NCS en el pedido.

Bathtub options p.191

* Specify the RAL / NCS in the order.

Options baignoires p.191

* Spécifiez le RAL / NCS dans la commande



Calma



Calma

sanitary**acrylic**

170x80x60h

170x80x66h



 Blanco brillo
Gloss white
Blanc brillant

Design by:

jorge herrera
studio.



Calma

Design by:
jorge herrera
studio.



Calma + ZOBNI5417080MA + BNEX001NB





Calma + ZOBN15417080MA + BABN1517080MA + BNEX001NB

Calma



Calma

Design by:
jorge herrera
studio.





Calma

Design by:
jorge herrera
studio.





Calma

Design by:
jorge herrera
studio.





Calma + PIBN15417080NM + BABN1517080MA + BNEX001MG

Calma

One design with multiple characters, do it yours

Un diseño con múltiples personalidades, hazlo tuyo

Un design aux multiples personnalités, faites-le vôtre

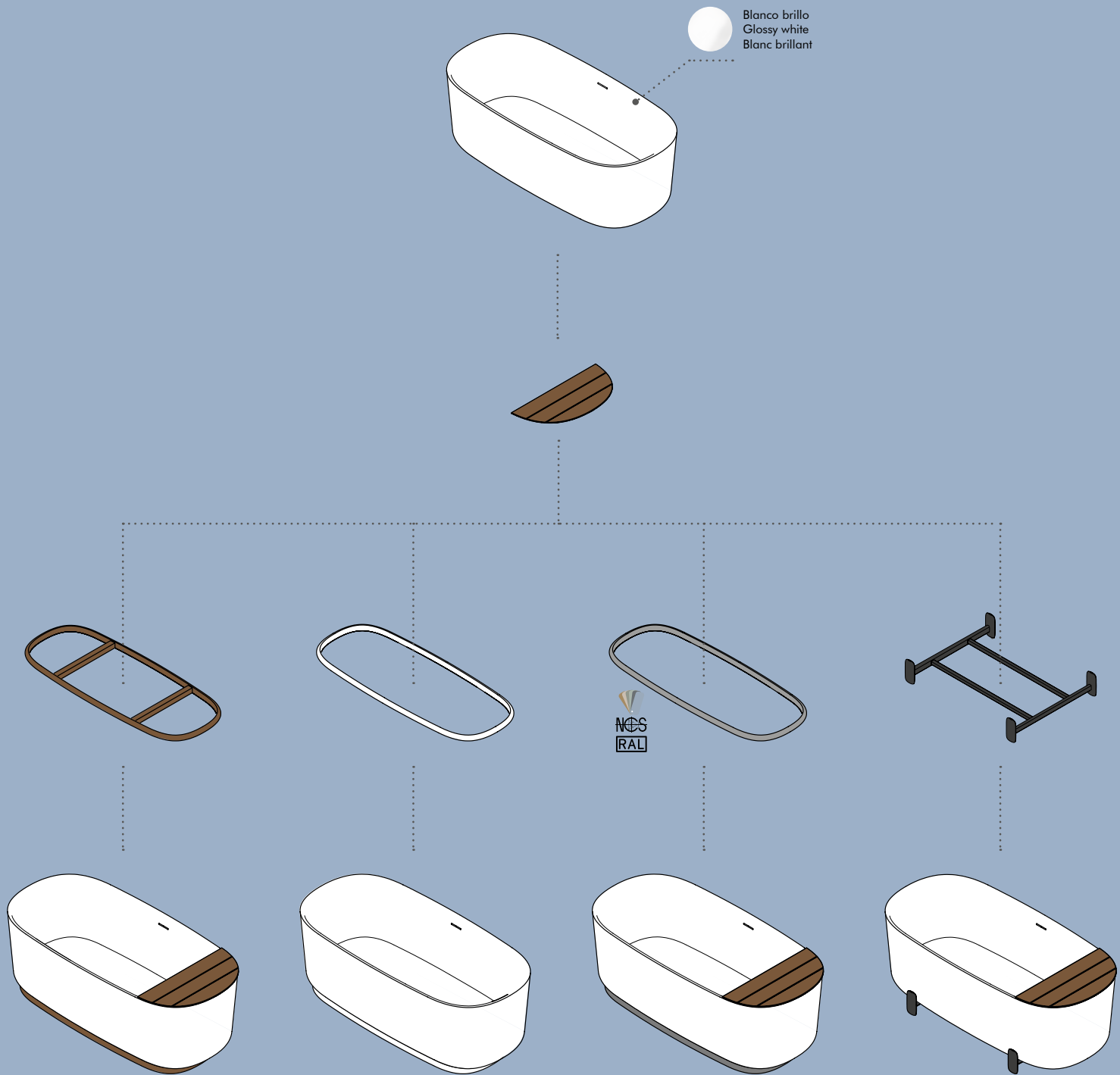

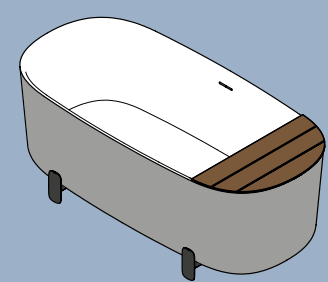
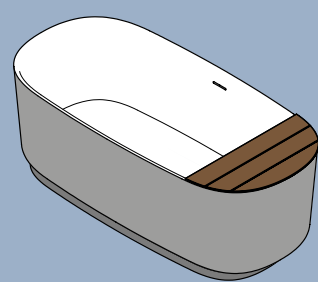
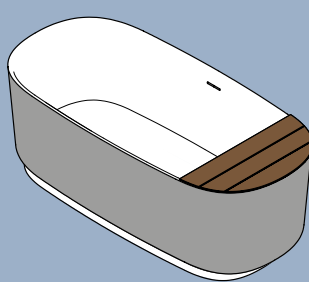
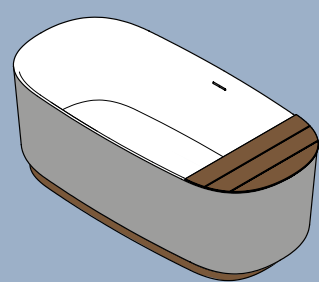
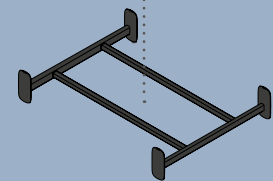
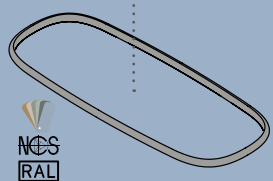
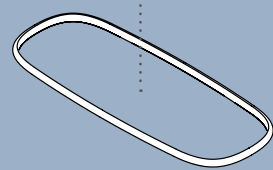
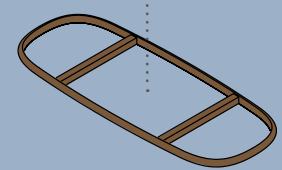
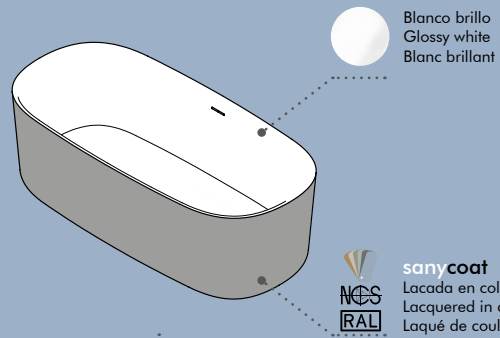

Calma

Accesorise it
Elige accesorios
Accessoirisez-le

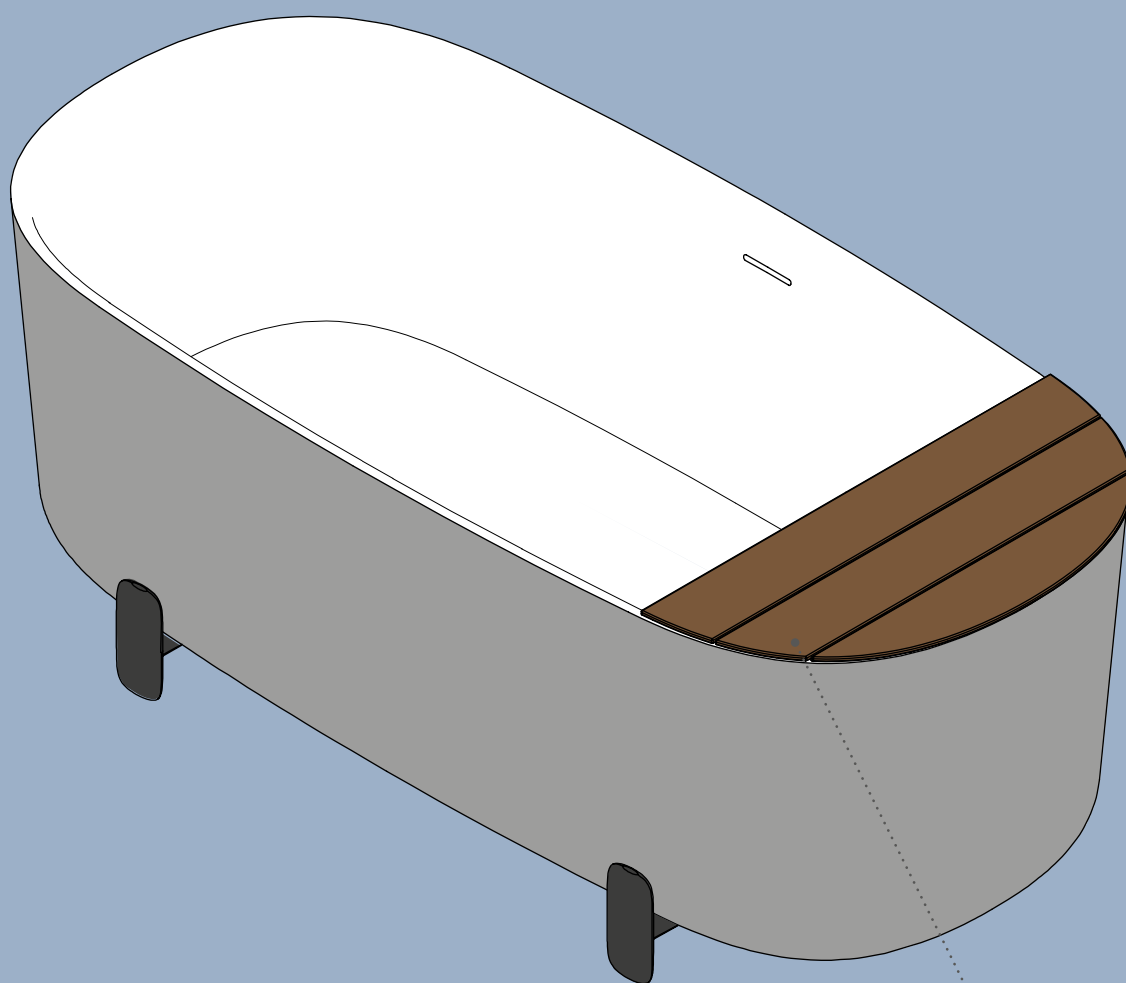

- : Bandeja Calma
- : Calma tray
- : Plateau Calma

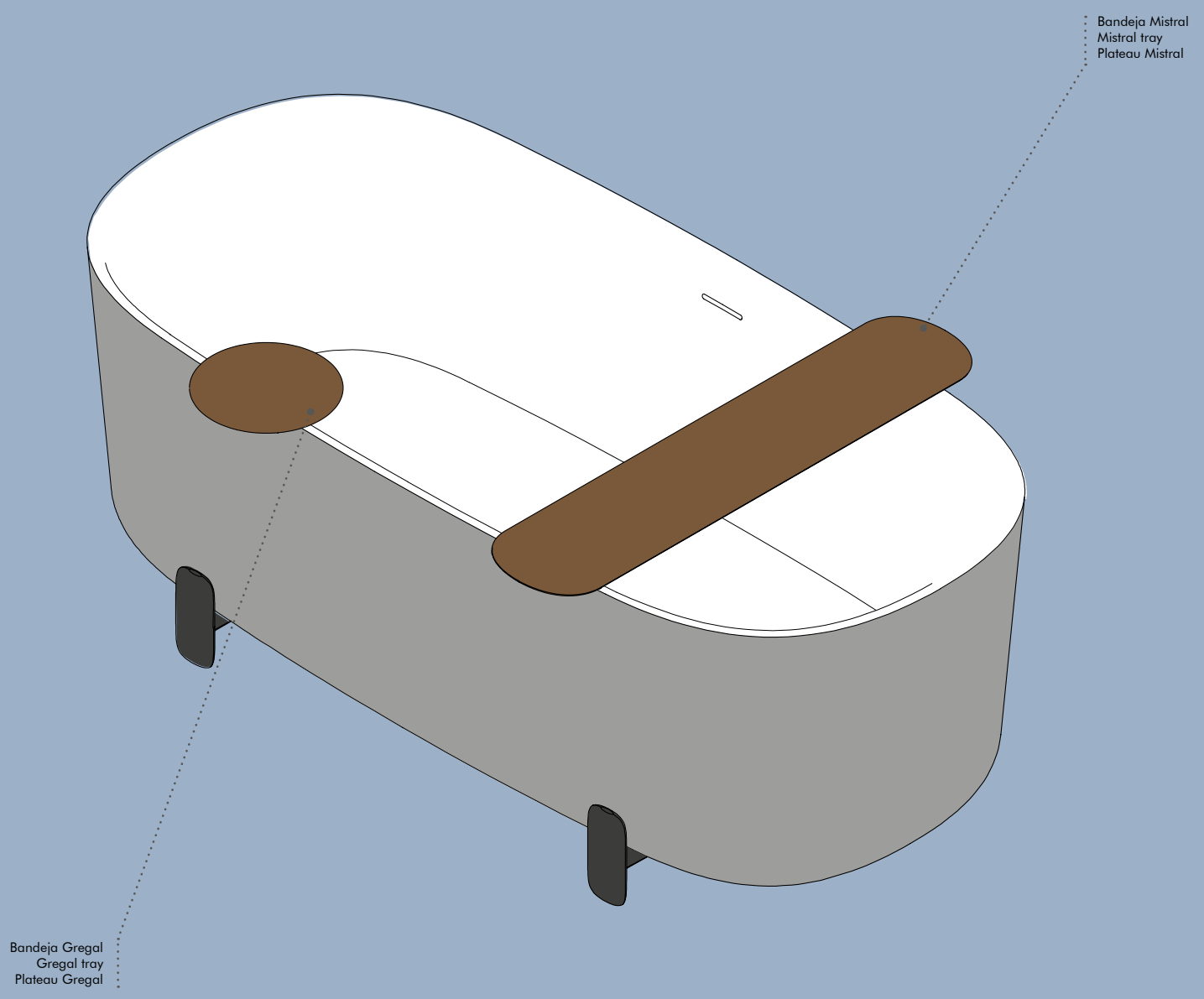

Calma

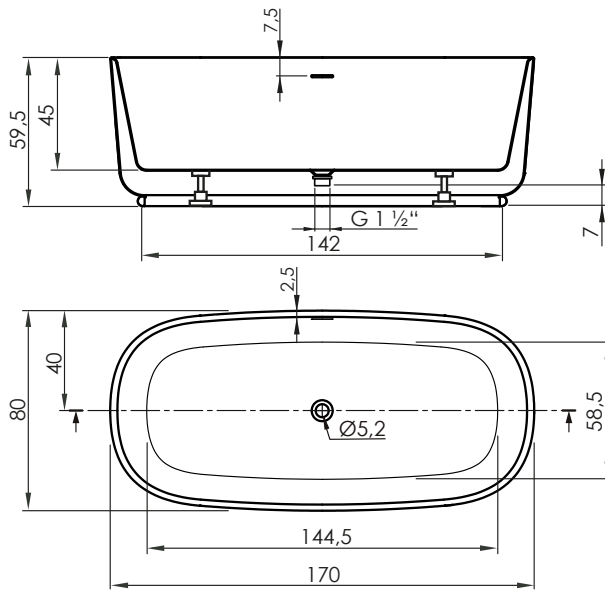

cm

CA
345 L

CA: Contenido agua / Water content / Contenu d'eau

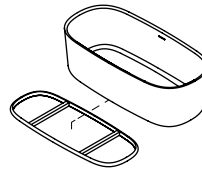

Calma 170x80 + zócalo
Calma 170x80 + plinth
Calma 170x80 + socle

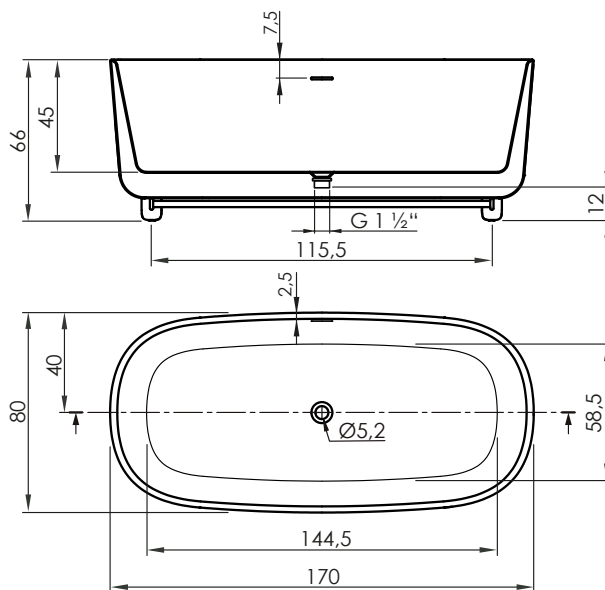

cm

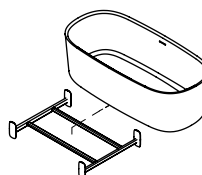











Calma 170x80 + pies
Calma 170x80 + feet
Calma 170x80 + pieds







Desagüe click-clack blanco incluido
White pop-up waste included
Bonde click-clack blanc incluse

Bañera / Bathtub / Baignoire

					Blanco brillo / Gloss white / Blanc brillant
		Calma 170x80		BN15417080BB	2.500 €
 sanycoat		Calma 170x80 sanycoat	*	BN15417080BBRAL	3.300 €
					Blanco brillo / Gloss white / Blanc brillant
					Madera Iroco / Iroko wood / Bois Iroko
		Zócalo acrílico bañera Calma Acrylic plinth for Calma bathtub Acrylique socle baignoire Calma		ZOBN15417080BB	230 €
				ZOBN15417080MA	1.200 €
 sanycoat		Zócalo acrílico bañera Calma Acrylic plinth for Calma bathtub Acrylique socle baignoire Calma sanycoat	*	ZOBN15417080BBRAL	500 €
					Nergo mate / Black Matt / Noir mat
		Pies metal bañera Calma Metal feet for Calma bathtub Métal pieds pour Baignoire		PIBN15417080NM	650 €

Accesorios / Accessories / Accessoires

					Madera Iroco / Iroko wood / Bois Iroko
		Bandeja bañera Calma Tray for Calma bathtub Plateau pour baignoire		BABN15417080MA	370 €
		Mistral bandeja de bañera 86x20cm Mistral tray for freestanding bathtubs 86x20cm Mistral plateau pour baignoire freestanding 86x20cm		BABN001MA	350 €
		Gregal bandeja portaobjetos Ø30 cm Gregal slide tray Ø30 cm Plateau à glissière Gregal Ø30 cm		BABN002MA	360 €

Opciones bañera p.191

* La bañera Calma siempre debe ir acompañada de un zócalo o pies.

Bathtub options p.191

* Calma bathtub must always be accompanied by a plinth or feet.

Options baignoires p.191

* La baignoire Calma doit toujours être accompagnée d'une socle ou de pieds.



Trento

sanitaryacrylic



 Trento gloss 170

Trento

sanitaryacrylic

150x75x57h

170x80x60h





Blanco mate
Matt white
Blanc mate



Blanco brillo
Gloss white
Blanc brillant



 Trento 170 white gloss

 Trento 150 matt



Trento 170 gloss + BNEX001NB

Trento





 Trento matt

Trento

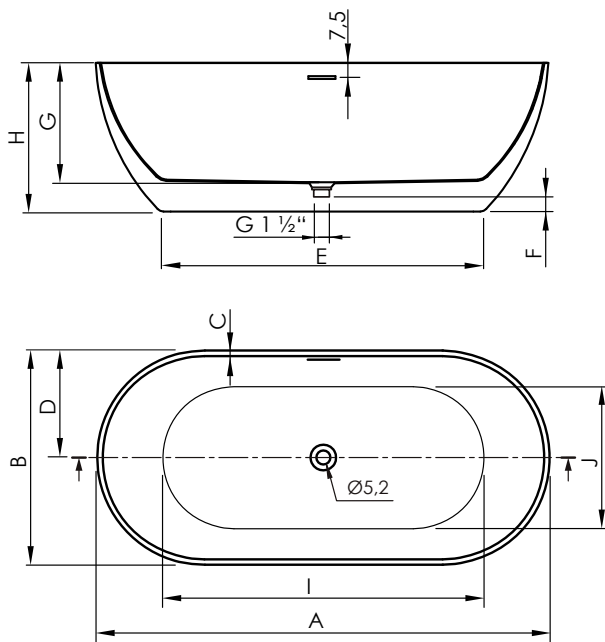

cm

dim.cm	A	B	C	D	E	F	G	H	I	J	CA
150x75	150	75	1,5	37,5	102	7	42	57	104	47	252L
170x80	170	80	1,5	40	124	6	45	60	124	52	305L

CA: Contenido agua / Water content / Contenu d'eau





Desagüe click-clack blanco incluido
 White pop-up waste included
 Bonde click-clack blanc incluse

Bañera / Bathtub / Baignoire

		Blanco mate / Matt white / Blanc mate	Blanco brillo / Gloss white / Blanc brillant
 sanycoat	 Trento 150x75	BN12515075BM 1.950 €	BN12515075 1.850 €
	 Trento 150x75 sanycoat *	BN12515075BMRAL 2.700 €	BN12515075RA 2.420 €
 sanycoat	 Trento 170x80	BN12517080BM 2.180 €	BN12517080 2.080 €
	 Trento 170x80 sanycoat *	BN12517080BMRAL 2.900 €	BN12517080RA 2.640 €

sanitary acrylic

Opciones / Options / Options

 Luz perimetral Perimeter light Lumière périmétrique	BNACC202 352 €
 Tratamiento antideslizante sanygrip Anti-slip treatment sanygrip Traitement antidérapant sanygrip	SGBN001 165 €

Opciones bañera p.191

* Especificar el RAL / NCS en el pedido.

Bathtub options p.191

* Specify the RAL / NCS in the order.

Options baignoires p.191

* Spécifiez le RAL / NCS dans la commande

Trento muro

sanitary **acrylic**

175x80x60h



Blanco brillo
Gloss white
Blanc brillant

Whirlpool

Opcional, hidromasaje
Optional, whirlpool
En option, hidromassage



 Trento Muro +  BNBB001BM



Trento Muro +  BNBB001BM

Trento muro





Trento Muro + BNBB001BM

Trento muro

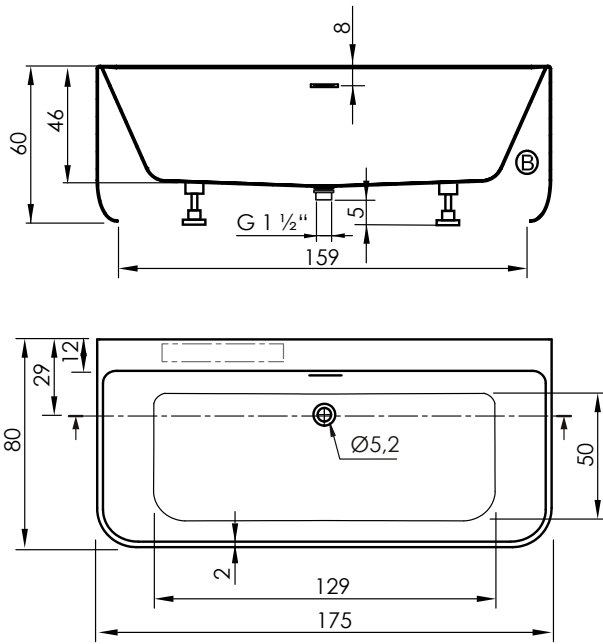

cm



Desagüe click-clack blanco incluido
White pop-up waste included
Bonde click-clack blanc incluse

CA
315 L

CA: Contenido agua / Water content / Contenu d'eau

Posición habitual de la grifería
Usual tap position
Position commune du robinet

Loop
Disposición 1
Mounting 1
assemblage 1

Loop K
Disposición 1
Mounting 1
assemblage 1

Cubo
Disposición 1
Mounting 1
assemblage 1

Air
Disposición 1
Mounting 1
assemblage 1

Kali
Disposición 1
Mounting 1
assemblage 1



SH



Elegance

Izquierda / Left / Gauche

Jets Airpool Jets Whirlpool Cromo LED P

Trento muro elegance 9 - 6 500 W

Bañera / Bathtub / Baignoire



Blanco brillo / Gloss white / Blanc brillant

		Trento muro 175x80 SH*		BN136	2.090 €
 sanycoat		Trento muro 175x80 SH* sanycoat	**	BN136RAL	2.750 €
		Trento muro 175x80 Elegance		BN136E	3.630 €
 sanycoat		Trento muro 175x80 Elegance sanycoat	**	BN136ERAL	4.290 €

Opciones / Options / Options

	Cromoterapia Chromotherapy Chromothérapie		BNACC171	750 €
	Mecanizado para grifería Tap holes Robinet perçage	***	ACRYLMEC	66 €
	Tratamiento antideslizante sanygrip Anti-slip treatment sanygrip Traitement antidérapant sanygrip		SGBN001	165 €

Opciones bañera p.191

Versión por defecto del hidromasaje: izquierdas.

* SH: producto sin hidromasaje.

** Especificar el RAL / NCS en el pedido.

*** Para griferías aportadas por el cliente.

Bathtub options p.191

Hydromassage default version: left.

* SH: product without whirlpool.

** Specify the RAL / NCS in the order.

*** For taps provided by the customer.

Options baignoires p.191

Version par défaut de l'hydromassage: gauche.

* SH: produit sans hydromassage.

** Spécifiez le RAL / NCS dans la comande

*** Pour les robinets fournis par le client.

Trento angolo

sanitary **acrylic**

178x130x60h Right

178x130x60h Left



○ Blanco brillo
Gloss white
Blanc brillant

Whirlpool

Opcional, hidromasaje
Optional, whirlpool
En option, hydromassage





Izquierda
Left
Gauche



Derecha
Right
Droite





 Trento Angolo left +  BNBB001BM

Trento angulo

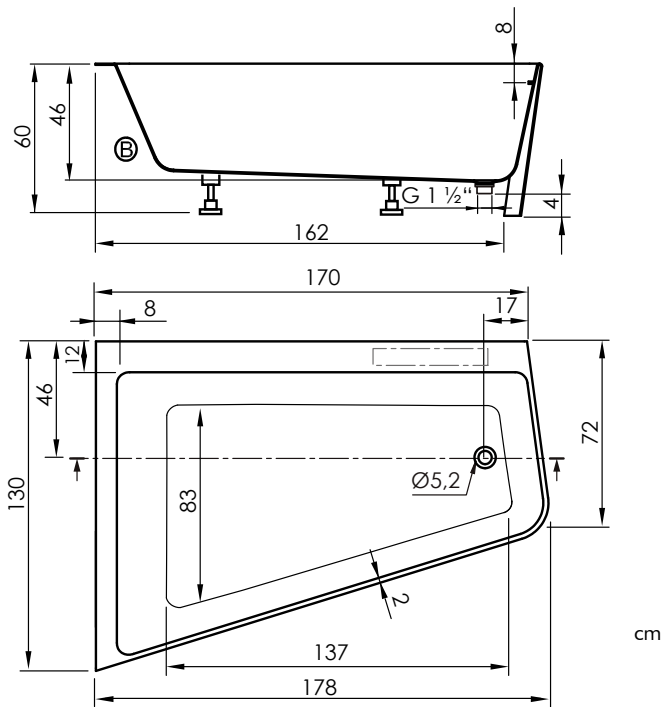

Desagüe click-clack cromado incluido
 Chrome pop-up waste included
 Bonde click-clack chromé incluse



Embellecedor rebosadero cromado
 Chrome overflow trim
 Garniture de trop-plein chromé

CA

400 L

CA: Contenido agua / Water content / Contenu d'eau

Posición habitual de la grifería
 Usual tap position
 Position commune du robinet



Loop
 Disposición 1
 Mounting 1
 assemblage 1



Loop K
 Disposición 1
 Mounting 1
 assemblage 1

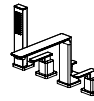

Cubo
 Disposición 1
 Mounting 1
 assemblage 1



Air
 Disposición 1
 Mounting 1
 assemblage 1



Kali
 Disposición 1
 Mounting 1
 assemblage 1



SH



Elegance

Izquierda / Left / Gauche

Jets Airpool

Jets Whirlpool

Cromo LED

P

Trento angulo elegance







10

-

5

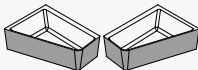

500 W

Bañera / Bathtub / Baignoire



		Blanco brillo Gloss white Blanc brillant		Blanco brillo Gloss white Blanc brillant	
		Izquierda Left Gauche		Derecha Right Droit	
		Trento angolo 178x130 SH*	BN137I	BN137D	2.550 €
		Trento angolo 178x130 SH* sanycoat	BN137IRAL	BN137DRAL	3.245 €
		Trento angolo 178x130 Elegance	BN137EI	BN137ED	4.840 €
		Trento angolo 178x130 Elegance sanycoat	BN137EIRAL	BN137EDRAL	5.500 €

sanitary acrylic

Opciones / Options / Options

	Cromoterapia Chromotherapy Chromothérapie	BNACC171	750 €
	Mecanizado para grifería Tap holes Robinet perçage	ACRYLMEC	66 €
	Tratamiento antideslizante sanygrip Anti-slip treatment sanygrip Traitement antidérapant sanygrip	SGBN001	165 €

Accesorios / Accesories / Accessoires

	Reposacabezas CN1 Head rest CN1 Repose-tête CN1	BNACC161	60 €
	Reposacabezas CN2 Head rest CN2 Repose-tête CN2	BNACC162	45 €

Opciones bañera p.150.
* SH: producto sin hidromasaje.
** Especificar el RAL / NCS en el pedido.
*** Para griferías aportadas por el cliente.

Bathtub options p.150.
* SH: product without whirlpool.
** Specify the RAL / NCS in the order.
*** For taps provided by the customer.

Options baignoires p.150.
* SH: produit sans hydromassage.
** Spécifiez le RAL / NCS dans la commande
*** Pour les robinets fournis par le client.



Dalia

sanitaryacrylic



 Dalia

Dalia

sanitary **acrylic**

180x80x71h



○ Blanco brillo
Gloss white
Blanc brillant





Dalia

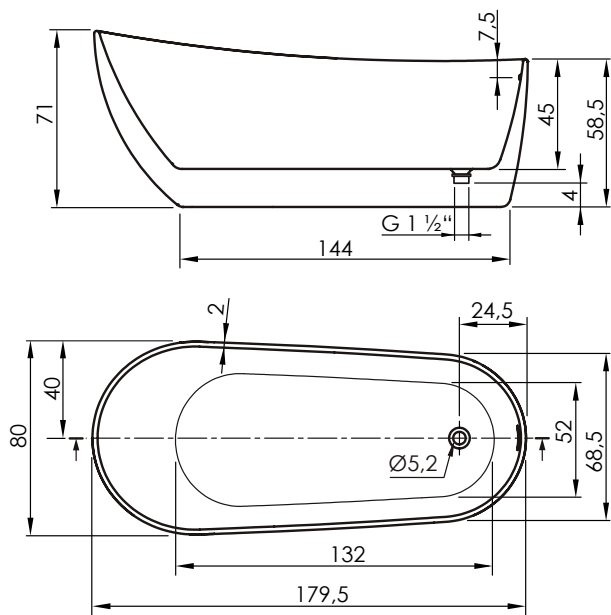

cm

CA





309 L

CA: Contenido agua / Water content / Contenu d'eau





Desagüe click-clack cromado incluido
Chrome plated pop-up waste included
Bonde click-clack chromée incluse

Bañera / Bathtub / Baignoire

 		Dalia 180x80		 Blanco brillo Gloss white Blanc brillant	BN131	2.310 €
		Dalia 180x80 sanycoat	*		BN131RAL	2.915 €

sanitary acrylic

Opciones / Options / Options

	Luz perimetral Perimeter light Lumière périmétrique		BNACC202	352 €
	Tratamiento antideslizante sanygrip Anti-slip treatment sanygrip Traitement antidérapant sanygrip		SGBN001	165 €

Opciones bañera p.191

* Especificar el RAL / NCS en el pedido.

Bathtub options p.191

* Specify the RAL / NCS in the order.

Options baignoires p.191

* Spécifiez le RAL / NCS dans la commande



Torino



Torino

sanitaryacrylic

170x80x58h



○ Blanco brillo
Gloss white
Blanc brillant



Whirlpool

Opcional, hidromasaje
Optional, whirlpool
En option, hidromassage





sanitaryacrylic

 Torino +  BNACC204

Torino

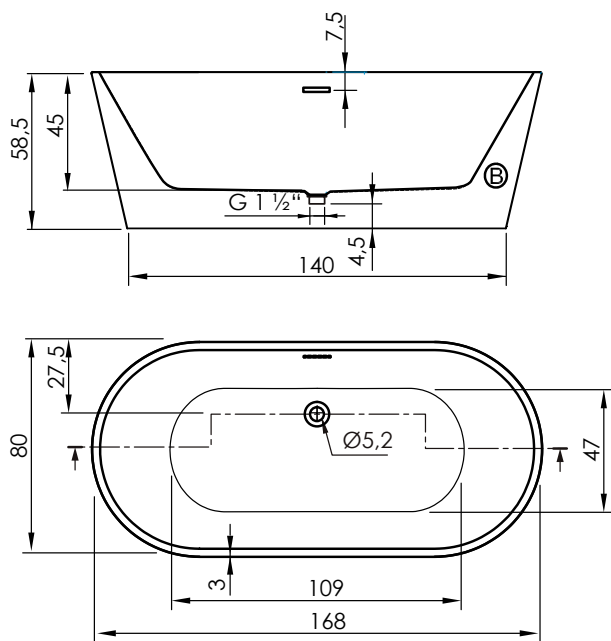

cm

CA

268 L

CA: Contenido agua / Water content / Contenu d'eau



Desagüe click-clack cromado incluido
 Chrome plated pop-up waste included
 Bonde click-clack chromée incluse



Embellecedor rebosadero cromado
 Chrome overflow trim
 Garniture de trop-plein chromé



SH



Elegance

Jets Airpool

Jets Whirlpool

Cromo LED

P

Torino elegance

8

-



-

400 W

Bañera / Bathtub / Baignoire

				 Blanco brillo Gloss white Blanc brillant	
	sanycoat		Torino 170x80 SH*	BN140	1.250 €
			Torino 170x80 SH* sanycoat **	BN140RAL	2.000 €
	sanycoat		Torino 170x80 elegace	BN140E	2.860 €
			Torino 170x80 elegace sanycoat **	BN140RALE	3.520 €

Opciones / Options / Options

	Luz perimetral Perimeter light Lumière périmétrique	BNACC202	352 €
	Cromoterapia Chromotherapy Chromothérapie	BNACC171	750 €
	Tratamiento antideslizante sanygrip Anti-slip treatment sanygrip Traitement antidérapant sanygrip	SGBN001	165 €

Accesorios / Accessories / Accessoires

	Reposacabezas CN3 Head rest CN3 Repose-tête CN3	BNACC163N	40 €
---	---	-----------	------

Opciones bañera p.191

* SH: producto sin hidromasaje.

** Especificar el RAL / NCS en el pedido.

Bathtub options p.191

* SH: product without whirlpool.

** Specify the RAL / NCS in the order.

Options baignoires p.191

* SH: produit sans hydromassage.

** Spécifiez le RAL / NCS dans la commande

Torino muro

sanitaryacrylic

170x80x57h



○ Blanco brillo
Gloss white
Blanc brillant

Whirlpool

Opcional, hidromasaje
Optional, whirlpool
En option, hidromassage





Torino Muro +  BNCA001MG / MH2D001MG / MH2000

Torino muro

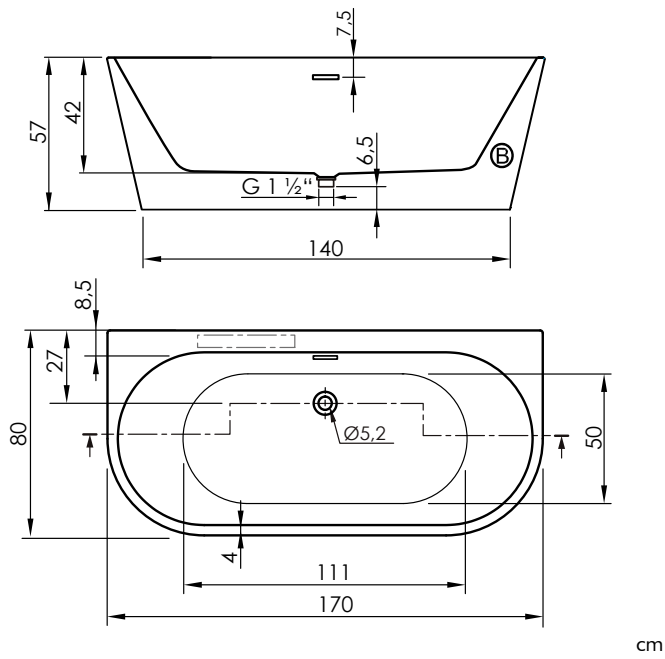

cm



Desagüe click-clack blanco incluido
White pop-up waste included
Bonde click-clack blanc incluse



Embellecedor rebosadero cromado
Chrome overflow trim
Garniture de trop-plein chromé

CA

227 L

CA: Contenido agua / Water content / Contenu d'eau

 Posición habitual de la grifería
Usual tap position
Position commune du robinet



Disposición 1
Mounting 1
assemblage 1



Disposición 1
Mounting 1
assemblage 1

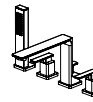

Disposición 1
Mounting 1
assemblage 1



Disposición 1
Mounting 1
assemblage 1



Disposición 1
Mounting 1
assemblage 1



SH



Elegance

Izquierda / Left / Gauche

Jets Airpool

Jets Whirlpool

Cromo LED

P

Torino muro elegance







8

-

-



500 W

Bañera / Bathtub / Baignoire

						 Blanco brillo Gloss white Blanc brillant
			Torino muro 170x80 SH*			BN141
					1.550 €	
	sanycoat		Torino muro 170x80 SH* sanycoat	**		BN141RAL
					2.100 €	
			Torino muro 170x80 elegance			BN141E
					3.080 €	
	sanycoat		Torino muro 170x80 elegance sanycoat	**		BN141ERAL
					3.740 €	

sanitary acrylic

Opciones / Options / Options

	Cromoterapia Chromotherapy Chromothérapie			BNACC171
				750 €
	Mecanizado para grifería Tap holes Robinet perçage		***	ACRYLMEC
				66 €
	Tratamiento antideslizante sanygrip Anti-slip treatment sanygrip Traitement antidérapant sanygrip			SGBN001
				165 €

Accesorios / Accessories / Accessoires

	Reposacabezas CN3 Head rest CN3 Repose-tête CN3			BNACC163N
				40 €

- | | | |
|---|--|--|
| Opciones bañera p.191
Versión por defecto del hidromasaje: izquierdas.
* SH: producto sin hidromasaje.
** Especificar el RAL / NCS en el pedido.
*** Para griferías aportadas por el cliente. | Bathtub options p.191
Hydromassage default version: left.
* SH: product without whirlpool.
** Specify the RAL / NCS in the order.
*** For taps provided by the customer. | Options baignoires p.191
Version par défaut de l'hydromassage: gauche.
* SH: produit sans hydromassage.
** Spécifiez le RAL / NCS dans la comande
*** Pour les robinets fournis par le client. |
|---|--|--|

Torino angolo

sanitaryacrylic

170x70x55h Right

170x70x55h Left



○ Blanco brillo
Gloss white
Blanc brillant

Whirlpool

Opcional, hidromasaje
Optional, whirlpool
En option, hydromassage



Izquierda
Left
Gauche



Derecha
Right
Droite



 Torino Angolo right

Torino angolo

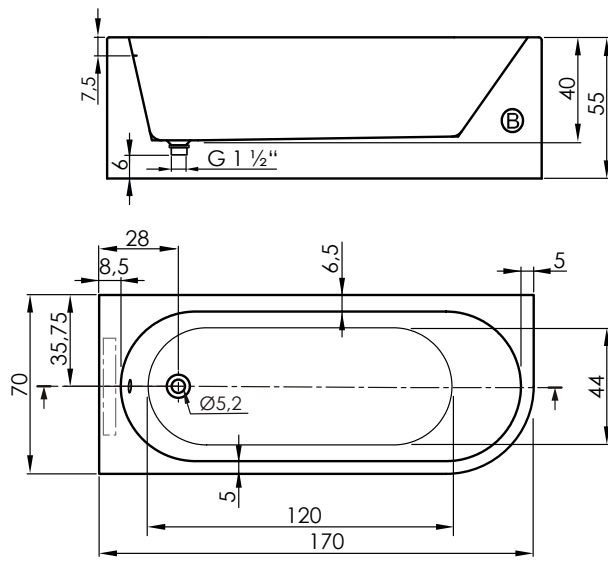

cm



Desagüe click-clack blanco incluido
White pop-up waste included
Bonde click-clack blanc incluse



Embellecedor rebozadero cromado
Chrome overflow trim
Garniture de trop-plein chromé

CA

182 L

CA: Contenido agua / Water content / Contenu d'eau

Posición habitual de la grifería
Usual tap position
Position commune du robinet



Disposición 1
Mounting 1
assemblage 1



Disposición 1
Mounting 1
assemblage 1

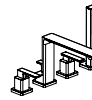

Disposición 1
Mounting 1
assemblage 1

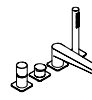

Disposición 1
Mounting 1
assemblage 1



Disposición 1
Mounting 1
assemblage 1



SH



Elegance

Izquierda / Left / Gauche

Jets Airpool

Jets Whirlpool

Cromo LED

P

Trento angolo elegance









8

-

-



500 W

Bañera / Bathtub / Baignoire

		Blanco brillo Gloss white Blanc brillant		Blanco brillo Gloss white Blanc brillant	
		Izquierda Left Gauche		Derecha Right Droit	
 sanycoat		Torino angulo 170x70 SH*			
			1.475 €		1.475 €
 sanycoat		Torino angulo 170x70 SH* sanycoat	**		
			2.100 €		2.100 €
 sanycoat		Torino angulo 170x70 Elegance			
			2.970 €		2.970 €
 sanycoat		Torino angulo 170x70 Elegance sanycoat	**		
			3.630 €		3.630 €

sanitary acrylic

Opciones / Options / Options

	Cromoterapia Chromotherapy Chromothérapie		BNACC171
			750 €
	Mecanizado para grifería Tap holes Robinet perçage	***	ACRYLMEC
			66 €
	Tratamiento antideslizante sanygrip Anti-slip treatment sanygrip Traitement antidérapant sanygrip		SGBN001
			165 €

Accesorios / Accessories / Accessoires

	Reposacabezas CN3 Head rest CN3 Repose-tête CN3		BNACC163N
			40 €

Opciones bañera p.191

* SH: producto sin hidromasaje.

** Especificar el RAL / NCS en el pedido.

*** Para griferías aportadas por el cliente.

Bathtub options p.191

* SH: product without whirlpool.

** Specify the RAL / NCS in the order.

*** For taps provided by the customer.

Options baignoires p.191

* SH: produit sans hydromassage.

** Spécifiez le RAL / NCS dans la commande

*** Pour les robinets fournis par le client.



Noa

sanitaryacrylic



 Noa Ø190 DS Confort +  BNACC195

Noa

sanitary **acrylic**

Ø160

Ø180

Ø190



Blanco brillo
Gloss white
Blanc brillant

Whirlpool

Opcional, hidromasaje
Optional, whirlpool
En option, hidromassage





Noa Ø190 DS Confort +

BNACC195

Noa

sanitary **acrylic**

Ø160

Ø180

Ø190



Blanco brillo
Gloss white
Blanc brillant

Whirlpool

Opcional, hidromasaje
Optional, whirlpool
En option, hidromassage





Noa Ø190-DS Confort + Faldón + BNACC204

Noa

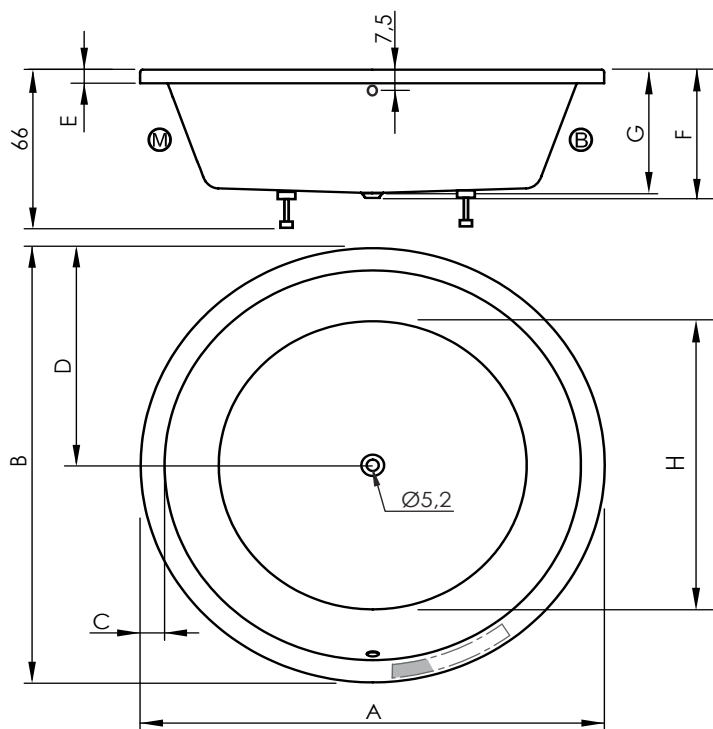

dim.cm	A	B	C	D	E	F	G	H	CA
$\varnothing 160$	160	160	10	80	5	52,5	50	100	411 L
$\varnothing 180$	180	180	10	90	5	52,5	50	120	563 L
$\varnothing 190$	190	190	10	95	5	52,5	50	130	647 L

CA: Contenido agua / Water content / Contenu d'eau

Posición habitual de la grifería
 Usual tap position
 Position commune du robinet



Disposición 1
Mounting 1
assemblage 1



Disposición 1
Mounting 1
assemblage 1

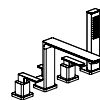

Disposición 1
Mounting 1
assemblage 1

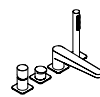

Disposición 1
Mounting 1
assemblage 1



Disposición 1
Mounting 1
assemblage 1



Posición habitual de la grifería
 Usual tap position
 Position commune du robinet



SH



B Confort



Confort



DS Confort





T Confort



Elegance

Bañera / Bathtub / Baignoire

	 Bañera Bathtub Baignoire			 Bañera con faldón Bathtub with panel Baignoire avec tablier		
	Ø160	Ø180	Ø190	Ø160	Ø180	Ø190
SH*	BN155D160 1.710 €	BN155D180 1.995 €	BN155D190 2.280 €	BN155D160FD 3.332 €	BN155D180FD 3.928 €	BN155D190FD 4.161 € **
Confort	BN155D160B 2.604 €	BN155D180B 3.179 €	BN155D190B 3.420 €	BN155D160BF 3.610 €	BN155D180BF 4.180 €	BN155D190BF 4.764 €
T Confort	BN155D160TT 3.610 €	BN155D180TT 3.990 €	BN155D190TT 4.503 €	BN155D160TTF 4.845 €	BN155D180TTF 5.130 €	BN155D190TTF 5.605 €
B Confort	BN155D160BW 3.800 €	BN155D180BW 4.218 €	BN155D190BW 4.674 €	BN155D160BWF 4.959 €	BN155D180BWF 5.244 €	BN155D190BWF 5.814 €
DS Confort	BN155D160DS 4.788 €	BN155D180DS 5.358 €	BN155D190DS 5.814 €	BN155D160DSF 5.928 €	BN155D180DSF 6.498 €	BN155D190DSF 7.200 €
Elegance	BN155D160E 6.384 €	BN155D180E 6.713 €	BN155D190E 7.320 €	BN155D160EF 7.524 €	BN155D180EF 8.094 €	BN155D190EF 8.394 €

	Jets Airpool	Jets Whirlpool	Cromo LED	P
	Ø160 / Ø180 / Ø190	Ø160 / Ø180 / Ø190	Ø160 / Ø180 / Ø190	Ø160 / Ø180 / Ø190
Confort	- / - / -	8 / 12 / 12	- / - / -	560 W
T Confort	- / - / -	8 / 12 / 12	- / - / -	560 W
B Confort	8 / 12 / 12	- / - / -	- / - / -	900 W
DS confort	8 / 12 / 12	8 / 12 / 12	- / - / -	1650 W
Elegance	12 / 24 / 24	12 / 12 / 12	12 / 12 / 12	1650 W

Opciones bañera p.191

Versión por defecto del hidromasaje: izquierdas.

* SH: producto sin hidromasaje.

** Desagüe incluido

Bathtub options p.191

Hydromassage default version: left.

* SH: product without whirlpool.

** Drain included

Options baignoires p.191

Version par défaut de l'hydromassage: gauche.

* SH: produit sans hydromassage.

** Bondé inclus



Loft

sanitaryacrylic



Loft 180x80 +  BNCA001MG / MH2B001MG / MH2000

Loft

sanitaryacrylic

180x80



○ Blanco brillo
Gloss white
Blanc brillant

Whirlpool

Opcional, hidromasaje
Optional, whirlpool
En option, hydromassage





Loft 180x80 +  BNCA001MG / MH2B001MG / MH2000

Loft



Bañera
Bathtub
Baignoire



Bañera con faldón
Bathtub with panel
Baignoire avec tablier



Loft

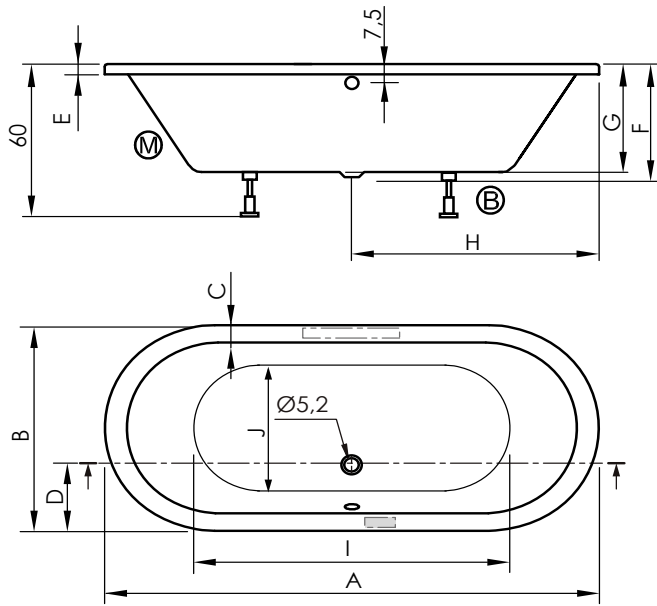

dim.cm	A	B	C	D	E	F	G	H	I	J	CA
180x80	180	80	9	26	3,5	44	42	90	115	49	209 L

CA: Contenido agua / Water content / Contenu d'eau

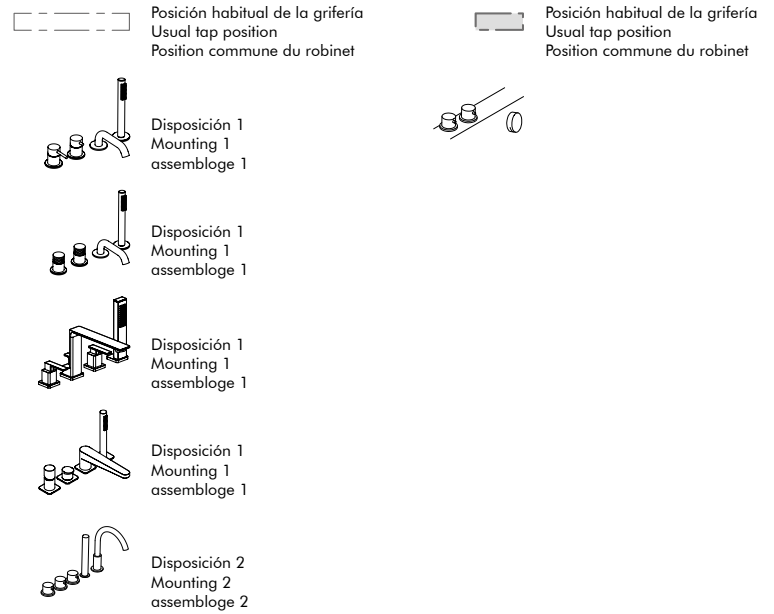

SH



B Confort



Confort



DS Confort



T Confort



Elegance

Izquierda / Left / Gauche

Bañera / Bathtub / Baignoire

	 Bañera Bathtub Baignoire	 Bañera con faldón Bathtub with panel Baignoire avec tablier
	BN120	BN120FALDES **
SH*	693 €	1.375 €
	BN120B	BN120BFAL
Confort	1.209 €	1.815 €
	BN120TT	BN120TFAL
T Confort	1.791 €	2.396 €
	BN120BW	BN120BWFAL
B Confort	1.918 €	2.523 €
	BN120DS	BN120DSFAL
DS Confort	2.074 €	2.624 €
	BN120E	BN120EFAL
Elegance	4.290 €	4.840 €

	Jets Airpool	Jets Whirlpool	Cromo LED	P
Confort	-	6	-	370 W
T Confort	-	6	-	560 W
B Confort	9	-	-	500 W
DS confort	9	6	-	1250 W
Elegance	9	10	10	1250 W

Opciones bañera p.191

Versión por defecto del hidromasaje: izquierdas.

* SH: producto sin hidromasaje.

** Desagüe incluido

Bathtub options p.191

Hydromassage default version: left.

* SH: product without whirlpool.

** Drain included

Options baignoires p.191

Version par défaut de l'hydromassage: gauche.

* SH: produit sans hydromassage.

** Bondé inclus



Cube

sanitaryacrylic



Cube

sanitaryacrylic

170x80x53,5h

180x80x53,5h

180x90x53,5h

190x90x53,5h

190x120x66h





○ Blanco brillo
Gloss white
Blanc brillant

Whirlpool

Opcional, hidromasaje
Optional, whirlpool
En option, hydromassage





 Cube 180x80 Confort +  FALREC180 / FALLAT80 +  BNCA001MG / MH2D001MG / MH2000

Cube





 Cube 190x120 Confort +  FALREC190 / FALLAT121120 +  BNBB001CR

Cube





 Cube 190x120 Confort +  FAL121190120 +  BNBB001CR

Cube

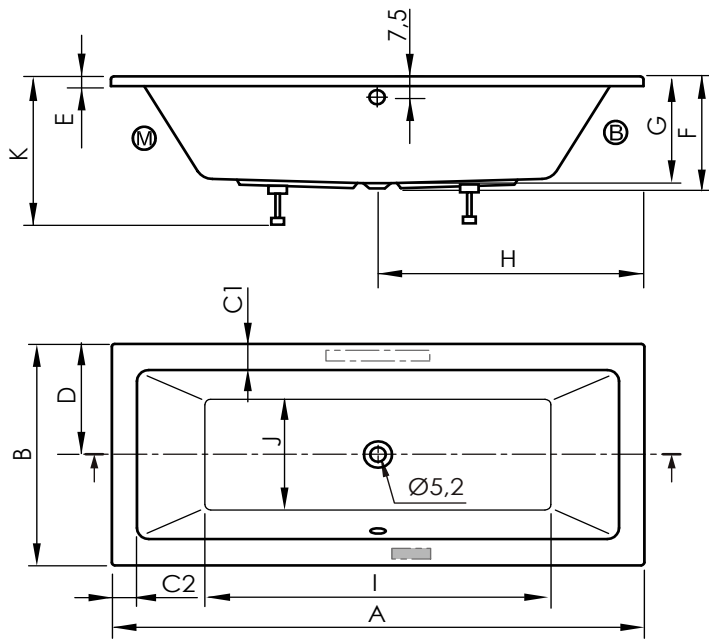

dim.cm	A	B	C1	C2	D	E	F	G	H	I	J	K	CA
170x80	170	80	9,5	8,5	40	3,5	40,5	38,5	85	107	40	53,3	178 L
180x80	180	80	9,5	8,5	40	3,5	40,5	38,5	90	117	40	53,3	185 L
180x90	180	90	9,5	8,5	45	3,5	40,5	38,5	90	117	50	53,3	212 L
190x90	190	90	9,5	8,5	45	3,5	40,5	38,5	95	127	50	53,3	240 L
190x120	190	120	9,5	8,5	60	3,5	52	50	95	127	75	66	485 L

CA: Contenido agua / Water content / Contenu d'eau

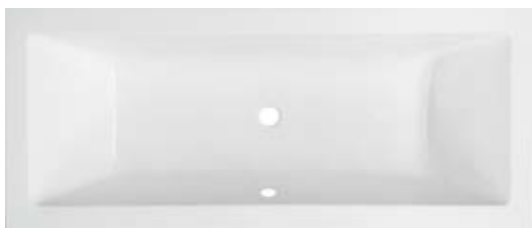
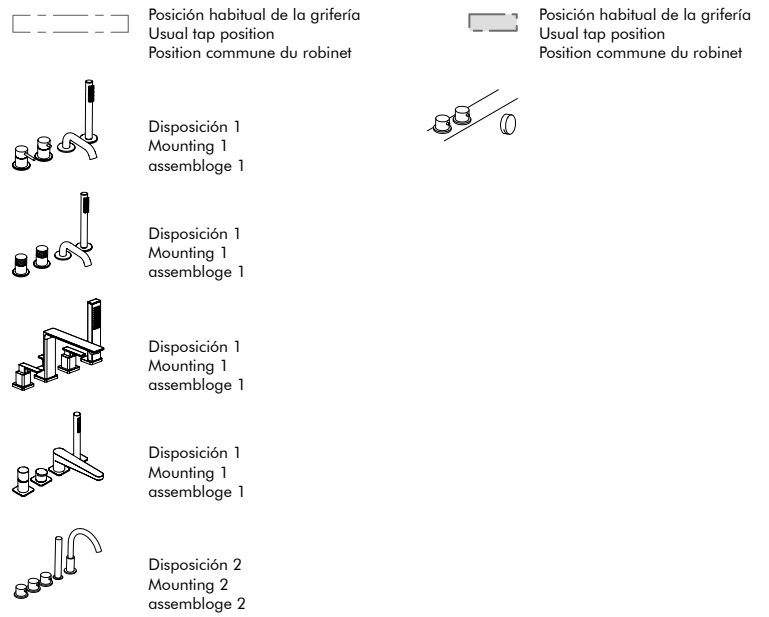

SH



B Confort



Confort



DS Confort



T Confort



Elegance

Izquierda / Left / Gauche

Bañera / Bathtub / Baignoire

	170x80	180x80	180x90	190x90	190x120
SH*	BN12117080 402 €	BN12118080 435 €	BN12118090 550 €	BN12119090 572 €	BN121190120 1.180 €
Confort	BN12117080B 950 €	BN12118080B 1.000 €	BN12118090B 1.100 €	BN12119090B 1.200 €	BN121190120B 1.815 €
T Confort	BN12117080TT 1.282 €	BN12118080TT 1.350 €	BN12118090TT 1.529 €	BN12119090TT 1.573 €	BN121190120TT 2.145 €
B Confort	BN12117080BW 1.471 €	BN12118080BW 1.580 €	BN12118090BW 1.730 €	BN12119090BW 1.936 €	BN121190120BW 2.335 €
DS Confort	BN12117080DS 1.980 €	BN12118080DS 2.002 €	BN12118090DS 2.169 €	BN12119090DS 2.200 €	BN121190120DS 3.740 €
Elegance	BN12117080E 4.180 €	BN12118080E 4.290 €	BN12118090E 4.345 €	BN12119090E 4.378 €	BN121190120E 5.940 €

	Jets Airpool B<120 / 190X120	Jets Whirlpool B<120 / 190X120	Cromo LED B<120 / 190X120	P B<120 / 190X120
Confort	- / -	6 / 8	- / -	370 W / 560 W
T Confort	- / -	6 / 8	- / -	560 W / 560 W
B Confort	10 / 16	- / -	- / -	500 W / 900 W
DS confort	10 / 16	6 / 8	- / -	1250 W / 1650 W
Elegance	10 / 20	10 / 10	10 / 10	1250 W / 1650 W

Opciones / Options / Options



Faldón acrílico Cube 190x120 cm freestanding
Freestanding Cube acrylic panel 190x120 cm
Freestanding tabier acrilique Cube 190x120 cm

FAL121190120

896 €

Opciones bañera p.191

Versión por defecto del hidromasaje: izquierdas.

* SH: producto sin hidromasaje.

Bathtub options p.191

Hydromassage default version: left.

* SH: product without whirlpool.

Options baignoires p.191

Version par défaut de l'hydromassage: gauche.

* SH: produit sans hydromassage.



Bali 170x75 + MDB001MGK

Bali



Bali

sanitaryacrylic

160x70

170x70

170x75

180x80



○ Blanco brillo
Gloss white
Blanc brillant



Whirlpool

Opcional, hidromasaje
Optional, whirlpool
En option, hidromassage





sanitaryacrylic

 Bali 170x75 +  MDB001CRK

Bali

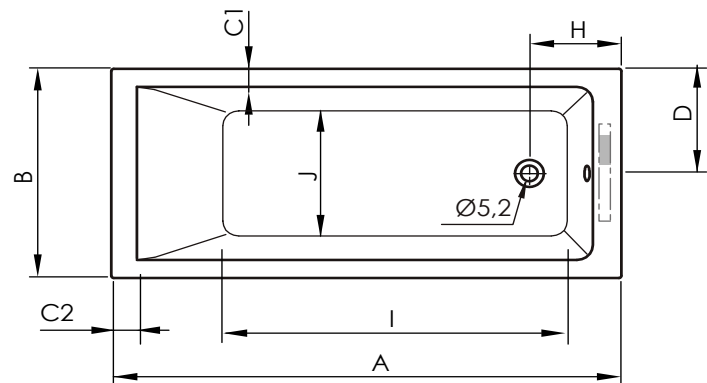
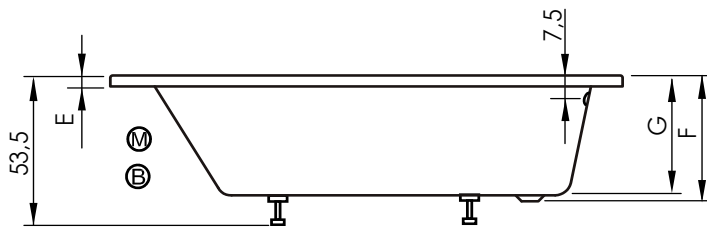

dim.cm	A	B	C1	C2	D	E	F	G	H	I	J	CA
160x70	160	70	6	9	35	3,5	42	40	29	108	42	170 L
170x70	170	70	6	9	35	3,5	42	40	29	118	42	185 L
170x75	170	75	6	9	37,5	3,5	42	40	29	118	47	201 L
180x80	180	80	6	9	40	3,5	42	40	29	128	52	223 L

CA: Contenido agua / Water content / Contenu d'eau



SH



B Confort



Confort



DS Confort



T Confort



Elegance

Bañera / Bathtub / Baignoire

	160x70	170x70	170x75	180x80
	BN12216070	BN12217070	BN12217075	BN12218080
SH*	322 €	334 €	345 €	380 €
	BN12216070B	BN12217070B	BN12217075B	BN12218080B
Confort	875 €	890 €	925 €	975 €
	BN12216070TT	BN12217070TT	BN12217075TT	BN12218080TT
T Confort	1.142 €	1.152 €	1.180 €	1.217 €
	BN12216070BW	BN12217070BW	BN12217075BW	BN12218080BW
B Confort	1.319 €	1.350 €	1.370 €	1.398 €
	BN12216070DS	BN12217070DS	BN12217075DS	BN12218080DS
DS Confort	1.771 €	1.800 €	1.830 €	1.871 €
	BN12216070E	BN12217070E	BN12217075E	BN12218080E
Elegance	3.960 €	3.990 €	4.015 €	4.070 €

	Jets Airpool	Jets Whirlpool	Cromo LED	P
	A<170 / A>170 cm / 190X120	A<170 / A>170 cm / 190X120	A<170 / A>170 cm / 190X120	A<170 / A>170 cm / 190X120
Confort	- / - / -	6 / 6 / 8	- / -	370 W / 370 W / 560 W
T Confort	- / - / -	6 / 6 / 8	- / -	560 W / 560 W / 560 W
B Confort	8 / 10 / 16	- / - / -	- / -	500 W / 500 W / 900 W
DS confort	8 / 10 / 16	6 / 6 / 8	- / -	1250 W / 1250 W / 1650 W
Elegance	8 / 10 / 20	8 / 10 / 10	8 / 10	1250 W / 1250 W / 1650 W

Opciones bañera p.191

Versión por defecto del hidromasaje: izquierdas.

* SH: producto sin hidromasaje.

Bathtub options p.191

Hydromassage default version: left.

* SH: product without whirlpool.

Options baignoires p.191

Version par défaut de l'hydromassage: gauche.

* SH: produit sans hydromassage.



Project

sanitaryacrylic



Project

sanitary acrylic

170x70

180x80



Blanco brillo
Gloss white
Blanc brillant

Whirlpool

Opcional, hidromasaje
Optional, whirlpool
En option, hidromassage





Project

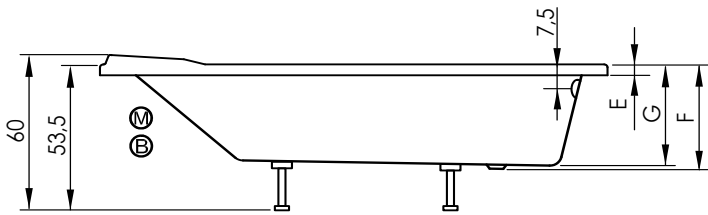

dim.cm	A	B	C1	C2	C3	D	E	F	G	H	I	J	CA
170x70	170	70	7	3,5	8	35	4,5	40,5	38,5	27	117	38	149 L
180x80	180	80	7	3,5	8	40	4,5	40,5	38,5	27	127	45	212 L

CA: Contenido agua / Water content / Contenu d'eau

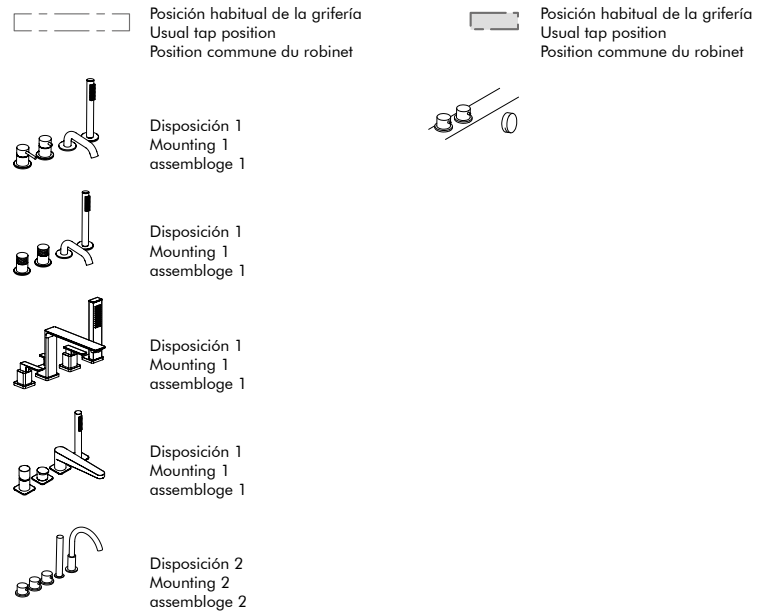
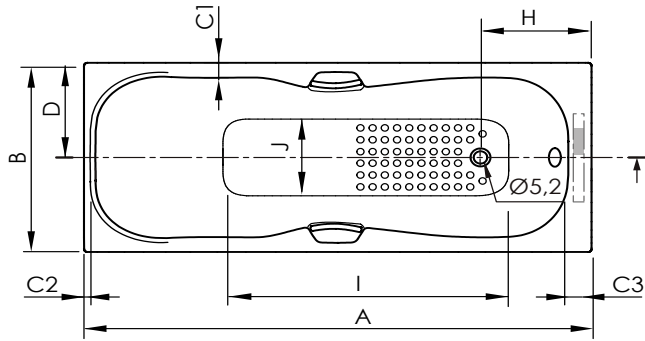

SH



B Confort



Confort



DS Confort



T Confort



Elegance

Izquierda / Left / Gauche

Bañera / Bathtub / Baignoire

	170x70	180x80
SH*	BN13217070 385 €	BN13218080 462 €
Confort	BN13217070B 990 €	BN13218080B 1.029 €
T Confort	BN13217070TT 1.353 €	BN13218080TT 1.430 €
B Confort	BN13217070BW 1.452 €	BN13218080BW 1.705 €
DS Confort	BN13217070DS 1.870 €	BN13218080DS 1.980 €
Elegance	BN13217070E 3.520 €	BN13218080E 3.575 €

	Jets Airpool	Jets Whirlpool	Cromo LED	P
Confort	-	6	-	370 W
T Confort	-	6	-	560 W
B Confort	10	-	-	500 W
DS confort	10	6	-	1250 W
Elegance	10	10	10	1250 W

Opciones bañera p.191

Versión por defecto del hidromasaje: izquierdas.

* SH: producto sin hidromasaje.

Bathtub options p.191

Hydromassage default version: left.

* SH: product without whirlpool.

Options baignoires p.191

Version par défaut de l'hydromassage: gauche.

* SH: produit sans hydromassage.



Serena



Serena

sanitaryacrylic

140x70

150x70

160x70

160x75

170x70

170x75

180x80







Blanco brillo
Gloss white
Blanc brillant

Whirlpool

Opcional, hidromasaje
Optional, whirlpool
En option, hydromassage





 Serena 170x75 Confort +  FALREC170 / FALLAT75+  BNACC163N  BNBB001CR

Serena

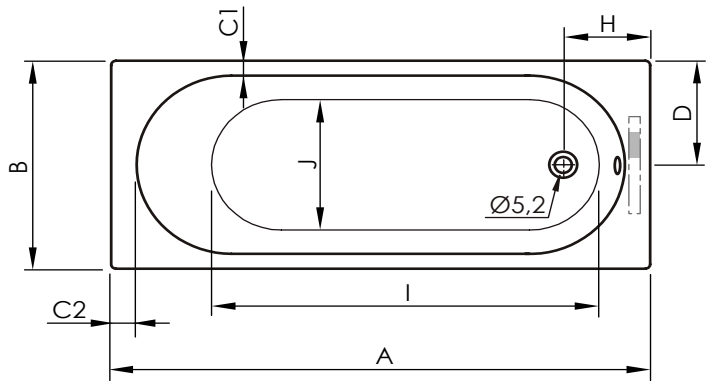
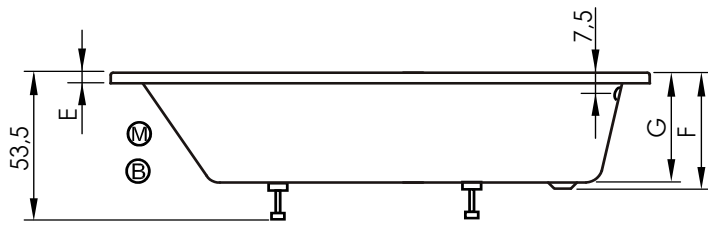

dim.cm	A	B	C1	C2	D	E	F	G	H	I	J	CA
140x70	140	70	5	8	35	3,5	40	37	27,5	92	44	127 L
150x70	150	70	5	8	35	3,5	40	37	27,5	101	44	140 L
160x70	160	70	5	8	35	3,5	40	37	27,5	112	44	146 L
160x75	160	75	5	8	37,5	3,5	40	37	27,5	112	47	150 L
170x70	170	70	5	8	35	3,5	40	37	27,5	122	44	157 L
170x75	170	75	5	8	37,5	3,5	40	37	27,5	122	47	184 L
180x80	180	80	5	8	40	3,5	40	37	27,5	132	50	200 L

CA: Contenido agua / Water content / Contenu d'eau



SH



B Confort



Confort



DS Confort



T Confort



Elegance

Izquierda / Left / Gauche

Bañera / Bathtub / Baignoire

	140x70	150x70	160x70	160x75	170x70	170x75	180x80
SH*	BN11814070 279 €	BN11815070 283 €	BN11816070 286 €	BN11816075 292 €	BN11817070 288 €	BN11817075 308 €	BN11818080 347 €
Confort	BN11814070B 790 €	BN11815070B 790 €	BN11816070B 790 €	BN11816075B 825 €	BN11817070B 790 €	BN11817075B 825 €	BN11818080B 875 €
T Confort	BN11814070TT 985 €	BN11815070TT 985 €	BN11816070TT 985 €	BN11816075TT 999 €	BN11817070TT 985 €	BN11817075TT 999 €	BN11818080TT 1.056 €
B Confort	BN11814070BW 1.113 €	BN11815070BW 1.113 €	BN11816070BW 1.113 €	BN11816075BW 1.130 €	BN11817070BW 1.113 €	BN11817075BW 1.130 €	BN11818080BW 1.160 €
DS Confort	BN11814070DS 1.485 €	BN11815070DS 1.485 €	BN11816070DS 1.485 €	BN11816075DS 1.595 €	BN11817070DS 1.485 €	BN11817075DS 1.595 €	BN11818080DS 1.815 €
Elegance	BN11814070E 3.025 €	BN11815070E 3.025 €	BN11816070E 3.025 €	BN11816075E 3.135 €	BN11817070E 3.025 €	BN11817075E 3.135 €	BN11818080E 3.300 €

	Jets Airpool A<170 / A>170 cm	Jets Whirlpool A<170 / A>170 cm	Cromo LED A<170 / A>170 cm	P
Confort	- / -	6 / 6	- / -	370 W
T Confort	- / -	6 / 6	- / -	560 W
B Confort	8 / 10	- / -	- / -	500 W
DS confort	8 / 10	6 / 6	- / -	1250 W
Elegance	8 / 10	8 / 10	8 / 10	1250 W

Opciones bañera p.191

Versión por defecto del hidromasaje: izquierdas.

* SH: producto sin hidromasaje.

Bathtub options p.191

Hydromassage default version: left.

* SH: product without whirlpool.

Options baignoires p.191

Version par défaut de l'hydromassage: gauche.



* SH: produit sans hydromassage.



Brisa

sanitaryacrylic



 Brisa 150x150 +  FAL153150 +  TDB001CRK

Brisa

sanitaryacrylic

130x130

140x140

150x150

160x160



○ Blanco brillo
Gloss white
Blanc brillant

Whirlpool

Opcional, hidromasaje
Optional, whirlpool
En option, hidromassage





 Brisa SH 150x150 +  FAL153150 +  TDB001MGK

Brisa

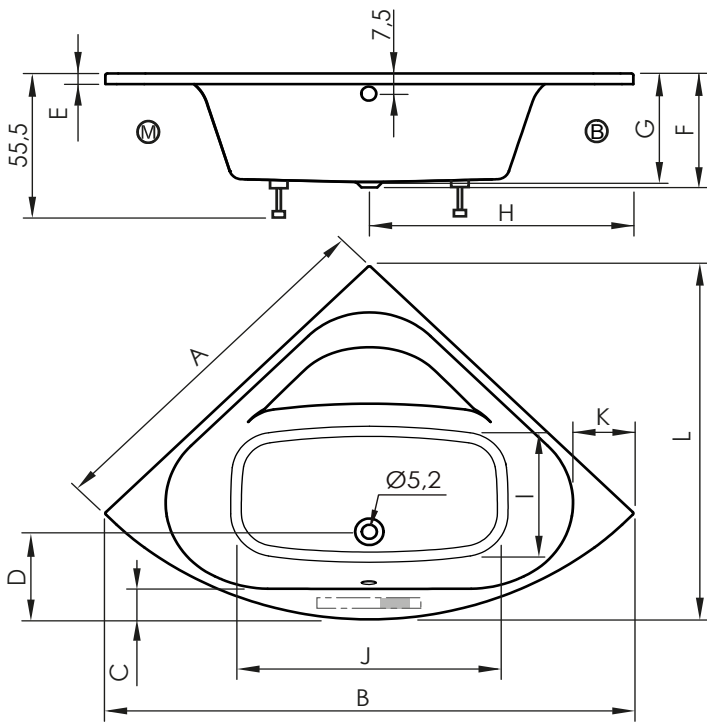

dim.cm	A	B	C	D	E	F	G	H	I	J	K	L	CA
130x130	130	183	11	32,5	4	42,5	40	91,5	47	93	21	131	150
140x140	140	197	11	32,5	4	42,5	40	99	58	107	18,5	145	200
150x150	150	212	11	32,5	4	42,5	40	106	67	121	20	159	146
160x160	160	226	11	32,5	4	42,5	40	113	76	136	19	173	301

CA: Contenido agua / Water content / Contenu d'eau

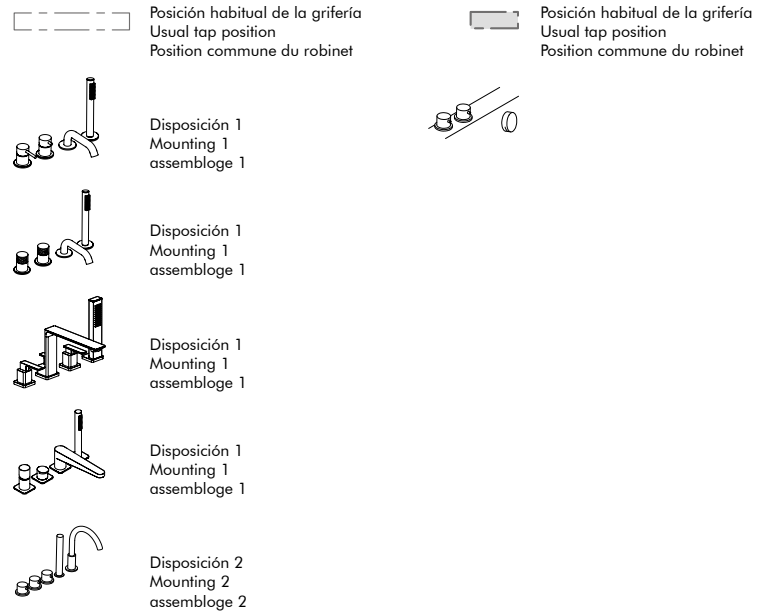

SH



B Confort



Confort



DS Confort



T Confort



Elegance

Izquierda / Left / Gauche

Bañera / Bathtub / Baignoire

	130x130	140x140	150x150	160x160
SH*	BN153130 520 €	BN153140 573 €	BN153150 851 €	BN153160 994 €
Confort	BN153130B 1.300 €	BN153140B 1.400 €	BN153150B 1.500 €	BN153160B 1.600 €
T Confort	BN153130TT 1.808 €	BN153140TT 1.900 €	BN153150TT 2.000 €	BN153160TT 2.120 €
B Confort	BN153130BW 1.995 €	BN153140BW 2.010 €	BN153150BW 2.170 €	BN153160BW 2.290 €
DS Confort	BN153130DS 2.200 €	BN153140DS 2.250 €	BN153150DS 2.320 €	BN153160DS 2.400 €
Elegance	BN153130E 3.000 €	BN153140E 3.100 €	BN153150E 3.300 €	BN153160E 3.500 €

Accesorios / Accessories / Accessoires



	130X130	140X140	150X150	160X160
Faldón Panel Tablier	FAL153130 200 €	FAL153140 230 €	FAL153150 323 €	FAL153160 372 €

	Jets Airpool 130 / 140 / 150 / 160	Jets Whirlpool 130 / 140 / 150 / 160	Cromo LED 130 / 140 / 150 / 160	P 130-140 / 150-160
Confort	- / - / - / -	6 / 6 / 6 / 6	- / - / - / -	370 W / 560 W
T Confort	- / - / - / -	6 / 6 / 6 / 6	- / - / - / -	560 W / 560 W
B Confort	9 / 10 / 10 / 10	- / - / - / -	- / - / - / -	500 W / 900 W
DS confort	9 / 10 / 10 / 10	6 / 6 / 6 / 6	- / - / - / -	1250 W / 1650 W
Elegance	9 / 10 / 14 / 14	6 / 6 / 10 / 10	6 / 6 / 10 / 10	1250 W / 1650 W

Opciones bañera p.191

Versión por defecto del hidromasaje: izquierdas.

* SH: producto sin hidromasaje.

Bathtub options p.191

Hydromassage default version: left.

* SH: product without whirlpool.

Options baignoires p.191

Versión par défaut de l'hydromassage: gauche.

* SH: produit sans hydromassage.



Tripoli



Tripoli

sanitaryacrylic

160x90 Right

160x90 Left



○ Blanco brillo
Gloss white
Blanc brillant

Whirlpool

Opcional, hidromasaje
Optional, whirlpool
En option, hidromassage



Izquierda
Left
Gauche



Derecha
Right
Droite





Tripoli Left Elegance + FAL108 MDB001CR

Tripoli

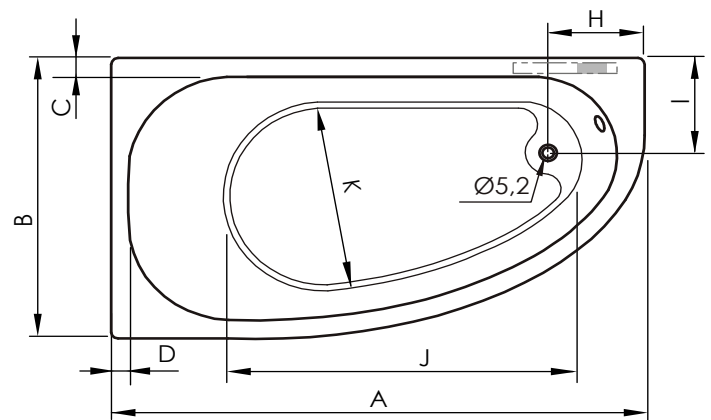
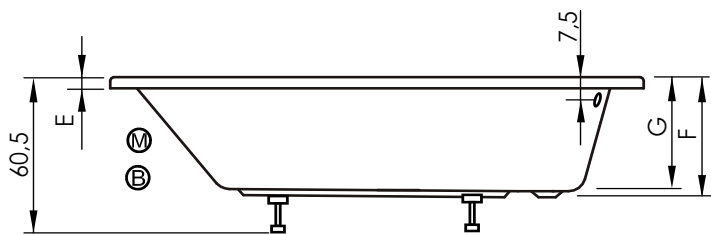

dim.cm	A	B	C1	D	E	F	G	H	I	J	K	CA
160x90	160	90	60	50	3,5	39	37	29	30,5	109	61	175 L

CA: Contenido agua / Water content / Contenu d'eau

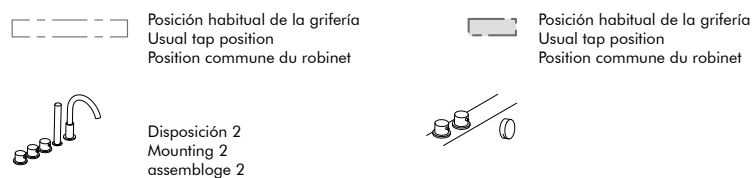

SH



B Confort



Confort



DS Confort





T Confort



Elegance

Izquierda / Left / Gauche

Bañera / Bathtub / Baignoire

	 Izquierda / Left / Gauche	 Derecha / Right / Droite
SH*	BN129I 495 €	BN129D 495 €
Confort	BN129BI 1.073 €	BN129BD 1.073 €
T Confort	BN129TI 1.716 €	BN129TD 1.716 €
B Confort	BN129BWI 1.960 €	BN129BWD 1.960 €
DS Confort	BN129DSI 2.200 €	BN129DSD 2.200 €
Elegance	BN129EI 4.290 €	BN129ED 4.290 €

Accesorios / Accessories / Accessoires



Faldón Panel Tablier	FAL108 255 €
----------------------------	-----------------

	Jets Airpool	Jets Whirlpool	Cromo LED	P
Confort	-	6	-	370 W
T Confort	-	6	-	560 W
B Confort	10	-	-	500 W
DS confort	10	6	-	1250 W
Elegance	10	6	6	1250 W

Opciones bañera p.191

* SH: producto sin hidromasaje.

Bathtub options p.191

* SH: product without whirlpool.

Options baignoires p.191

* SH: produit sans hydromassage.



Whirlpool bathtubs

Bañeras hidromasaje

Balneo

Los equipamientos de hidromasaje de nuestras bañeras las transforman en un potente aliado anti-estrés. Sumérgete y disfruta de sus múltiples beneficios.

The hydromassage equipments of our bathtubs transform them into a powerful anti-stress ally. Immerse yourself and enjoy its multiple benefits.

L'équipement d'hydromassage de nos baignoires les transforme en un puissant allié anti-stress. Plongez-vous et profitez de ses multiples avantages.

Relaja la tensión muscular
Fortalece los músculos
Activa la circulación sanguínea
Reduce la celulitis
El agua caliente abre los poros, lo que facilita la eliminación de toxinas

Relaxes muscle tension
Strengthens muscles
Activates blood circulation.
Reduces cellulite
Hot water opens the pores, which facilitates the elimination of toxins.

Détend la tension musculaire
Renforce les muscles
Active la circulation sanguine
Réduit la cellulite
L'eau chaude ouvre les pores, ce qui facilite l'élimination des toxines

Sistema de hidromasaje lateral por efecto venturi. Bomba de hidromasaje con encendido neumático.

Lateral whirlpool system by Ventury effect. Neumatic ignition whirlpool pump.

Système d'hydromassage latéral par effet Venturi. Système pneumatique de mise en marche de la pompe d'hydromassage.



Sistema de hidromasaje lateral por efecto venturi. Bomba de hidromasaje con encendido electrónico, pulsador táctil y sensor de nivel.

Lateral whirlpool system by Ventury effect. Electronic ignition whirlpool pump, tactile display and level sensor.

Système d'hydromassage latéral par effet Venturi. Système électronique de mise en marche à l'aide d'un bouton tactile de la pompe d'hydromassage et capteur de niveau.



Inyección de aire en el fondo de la bañera. Soplante con encendido electrónico, pulsador táctil, sensor de nivel y vaciado automático de tuberías.

Air injection in to the bathtub bottom. Blower with electronic ignition, tactile display, level sensor and authomatic drain pipes function.

Injection d'air dans le fond de la baignoire. Souffleur avec mise en marche électronique, bouton tactile, capteur de niveau et système de bonde automatique de la tuyauterie.



Whirlpool bathtubs

Bañeras hidromasaje

Balneo

SH

casco
bastidor y patas

body
frame and legs

corps
cadre et pattes



Confort

casco
bastidor y patas
motor hidro
jets hidro Confort orientables
pulsador neumático
regulador de aire
desagüe

body
frame and legs
whirlpool pump
orientable hydro Confort jets
pneumatic button
air regulator
waste

corps
cadre et pattes
pompe hydro
buses hydro Confort orientables
commande pneumatique
régulateur d'air
bonde

Whirlpool



T Confort

casco
bastidor y patas
motor hidro
jets hidro Confort orientables
panel táctil retroiluminado
sensor de nivel
desagüe

body
frame and legs
whirlpool pump
orientable hydro Confort jets
tactile display with light
level sensor
waste

corps
cadre et pattes
pompe hydro
buses hydro Confort orientables
clavier de commande tactile rétroéclairé
détecteur de niveau
bonde



B Confort

casco
bastidor y patas
motor blower
jets blower Confort
panel táctil retroiluminado
sensor de nivel
sistema autovaciado
blower
desagüe

body
frame and legs
blower pump
Confort blower jets
tactile display with light
level sensor
self-emptying blower system
waste

corps
cadre et pattes
pompe blower
buses blower Confort
clavier de commande tactile rétroéclairé
détecteur de niveau
système auto-bonde «blower»
bonde

Sistema de hidromasaje lateral por efecto venturi. Sistema de inyección de aire en el fondo de la bañera. Encendidos electrónicos, pulsadores táctiles, sensor de nivel y vaciado automático de tuberías (solo las del sistema de inyección de aire)

Lateral whirlpool system by Ventury effect. Air injection in to the bathtub bottom. Electronic ignitions, tactile display, level sensor and authomatic drain pipes function (only in air injection system).

Système d'hydromassage latéral par effet Venturi. Système d'injection d'air dans le fond de la baignoire. Mises en marche électronique, boutons tactiles, capteur de niveau et système de bonde automatique de la tuyauterie (seulement celle relie au système d'injection d'air)



Sistema de hidromasaje lateral por efecto venturi. Sistema de inyección de aire en el fondo de la bañera. Cromoterapia perimetral. Encendidos electrónicos, pulsadores inox, sensor de nivel y vaciado automático de tuberías (solo las del sistema de inyección de aire). Jets aire e hidro en latón cromado.

Lateral whirlpool system by Ventury effect. Air injection in to the bathtub bottom. Perimetral cromoteraphy. Electronic ignitions, stainless steel puSH buttons, level sensor and authomatic drain pipes function (only in air injection system). Air and hydro jets in chromed brass

Système d'hydromassage latéral par effet Venturi. Système d'injection d'air dans le fond de la baignoire. Chromothérapie sur le périmètre. Mises en marche électroniques, boutons poussoir inox, capteur de niveau et système de bonde automatique de la tuyauterie (seulement celle relie au système d'injection d'air). Les jets air et hydro sont en laiton chromée



Whirlpool bathtubs

Bañeras hidromasaje

Balneo

DS Confort



casco
bastidor y patas
motor hidro
jets hidro Confort
orientables
motor blower
jets blower Confort
panel táctil
retroiluminado
sensor de nivel
sistema autovaciado
blower
desagüe

body
frame and legs
whirlpool pump
orientable hydro
Confort jets
blower pump
Confort blower jets
tactile display with light
level sensor
self-emptying blower
system
waste

corps
cadre et pattes
pompe hydro
buses hydro Confort
orientables
pompe blower
buses blower Confort
clavier de commande
tactile rétroéclairé
détecteur de niveau
système auto-bonde
«blower»
bonde

Elegance



casco
bastidor y patas
motor hidro
jets hidro Elegance
orientables
motor blower
jets blower Elegance
pulsadores On-Off
inox y retroiluminados
sensor de nivel
sistema autovaciado
blower
cromoterapia LED
desagüe

body
frame and legs
whirlpool pump
orientable hydro
Elegance jets
blower pump
Elegance blower jets
puSH On-Off
inox with light
level sensor
self-emptying blower
system
LED chromoterapie
waste

corps
cadre et pattes
pompe hydro
buses hydro Elegance
orientables
pompe blower
buses blower Elegance
bouton poussoir On-Off
inox et rétroéclairé
détecteur de niveau
système auto-bonde
«blower»
chromothérapie LED
bonde



Bathtubs options

Opciones de bañeras

Options pur baignoires



Loop

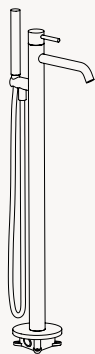
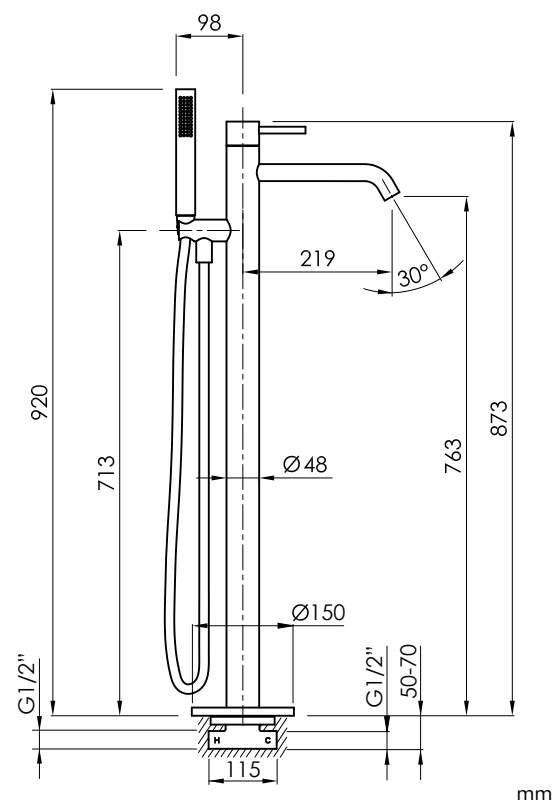

	CR	BM	MG	NB	BG	RG
	BNACC204	BNACC205	BNEX001MG	BNEX001NB	BNEX001BG	BNEX001RG
	1.040 €	1.210 €	1.595 €	1.595 €	1.595 €	1.595 €



Options

 BNACC205

Loop K

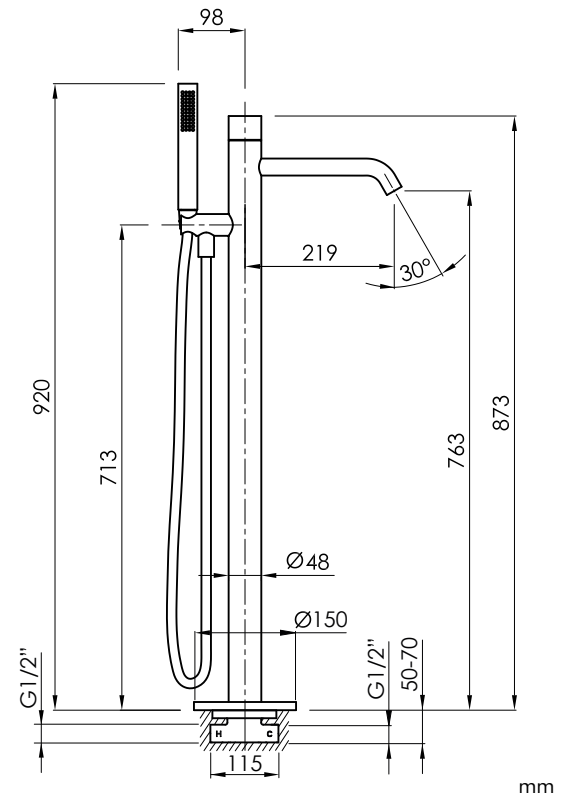

A \ B	CR	BM	MG	NB	BG	RG
CR	BNEX011CRCR 1.111 €	BNEX011CRBM 1.276 €	BNEX011CRMG 1.430 €	BNEX011CRNB 1.430 €	BNEX011CRBG 1.430 €	BNEX011CRRG 1.430 €
BM	BNEX011BMCR 1.276 €	BNEX011BMBM 1.282 €	BNEX011BMMG 1.650 €	BNEX011BMNB 1.650 €	BNEX011BMBG 1.650 €	BNEX011BMRG 1.650 €
MG	BNEX011MGCR 1.650 €	BNEX011MGBM 1.650 €	BNEX011MGMG 1.650 €	BNEX011MGNB 1.650 €	BNEX011MGBG 1.650 €	BNEX011MGRG 1.650 €
NB	BNEX011NBCR 1.650 €	BNEX011NBBM 1.650 €	BNEX011NBMG 1.650 €	BNEX011NBNB 1.650 €	BNEX011NBBG 1.650 €	BNEX011NBRG 1.650 €
BG	BNEX011BGCR 1.650 €	BNEX011BGBM 1.650 €	BNEX011BGMG 1.650 €	BNEX011BGNB 1.650 €	BNEX011BGBG 1.650 €	BNEX011BGRG 1.650 €
RG	BNEX011RGCR 1.650 €	BNEX011RGBM 1.650 €	BNEX011RGMG 1.650 €	BNEX011RGNB 1.650 €	BNEX011RGBG 1.650 €	BNEX011RGRG 1.650 €

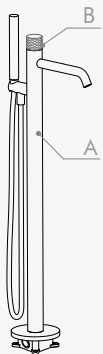



Options

 BNEX011BGBG

Cubo

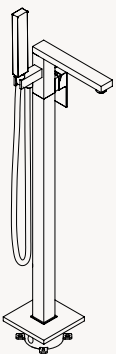
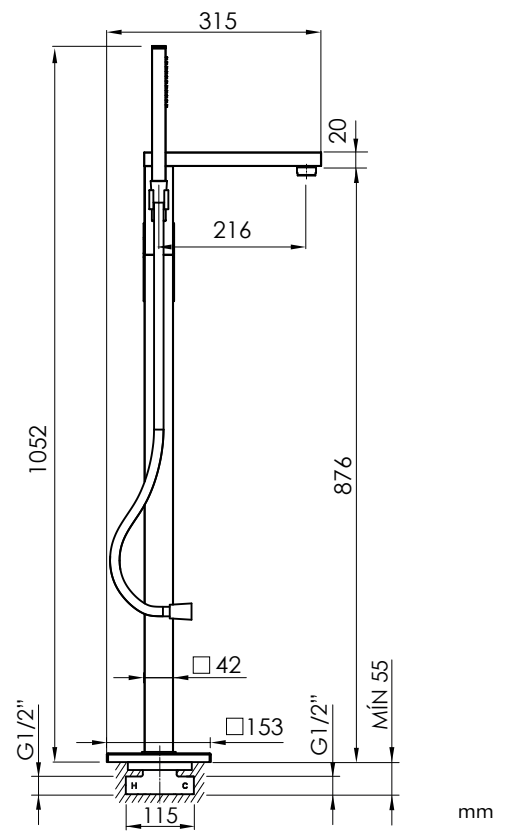

BNEX002CR

1.067 €

BNEX002BM

1.276 €



Options

 BNEX002CR

Nira

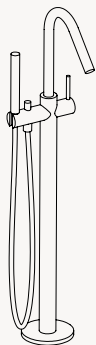
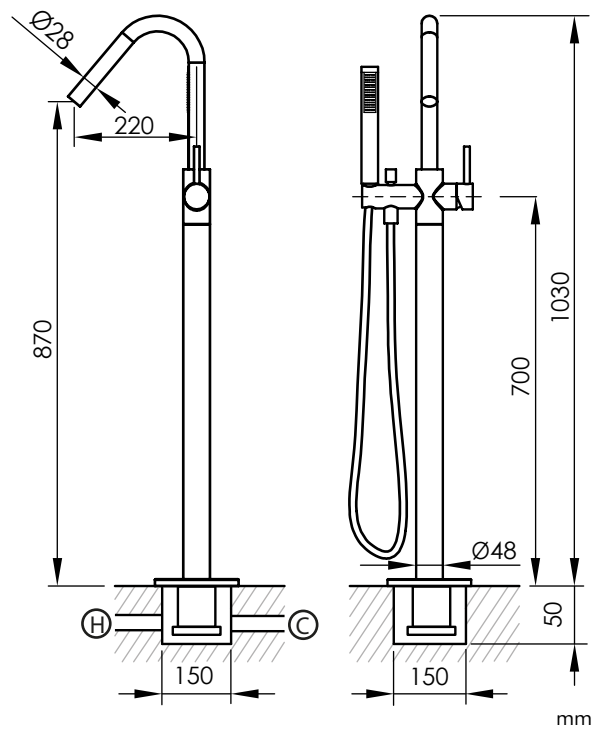

BNACC159

1.029 €



Loop



 BNBB001CR

Loop K



 BNBB011CRCR

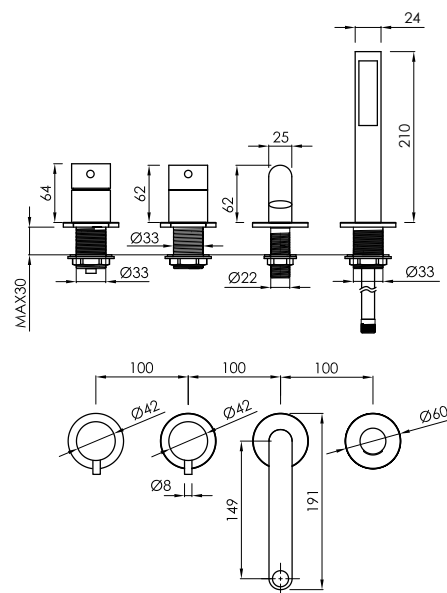

mm

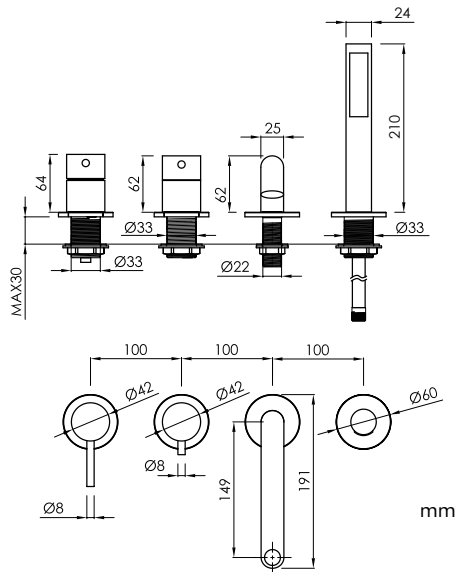

CR	BM	MG	NB	BG	RG
BNBB001CR	BNBB001BM	BNBB001MG	BNBB001NB	BNBB001BG	BNBB001RG
468 €	528 €	550 €	550 €	550 €	550 €

A \ B						
	CR	BM	MG	NB	BG	RG
	BNBB011CRCR 539 €	BNBB011CRBM 594 €	BNBB011CRMG 627 €	BNBB011CRNB 627 €	BNBB011CRBG 627 €	BNBB011CRRG 627 €
	BNBB011BMCR 594 €	BNBB011BMBM 600 €	BNBB011BMMG 627 €	BNBB011BMNB 627 €	BNBB011BMBG 627 €	BNBB011BMRG 627 €
	BNBB011MGCR 627 €	BNBB011MGBM 627 €	BNBB011MGMG 627 €	BNBB011MGNB 627 €	BNBB011MGBG 627 €	BNBB011MGRG 627 €
	BNBB011NBCR 627 €	BNBB011NBBM 627 €	BNBB011NBMG 627 €	BNBB011NBNB 627 €	BNBB011NBBG 627 €	BNBB011NBRG 627 €
	BNBB011BGCR 627 €	BNBB011BGBM 627 €	BNBB011BGMG 627 €	BNBB011BGNB 627 €	BNBB011BGBG 627 €	BNBB011BGRG 627 €
	BNBB011RGCR 627 €	BNBB011RGBM 627 €	BNBB011RGMG 627 €	BNBB011RGNB 627 €	BNBB011RGBG 627 €	BNBB011RGRG 627 €

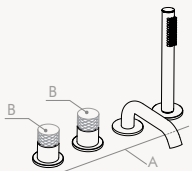

Cubo



Air



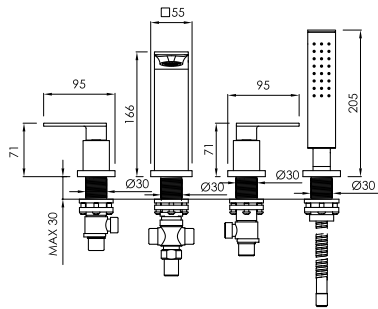

mm

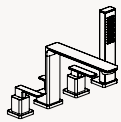

CR	BM
BNBB002CR	BNBB002BM
578 €	660 €

Options

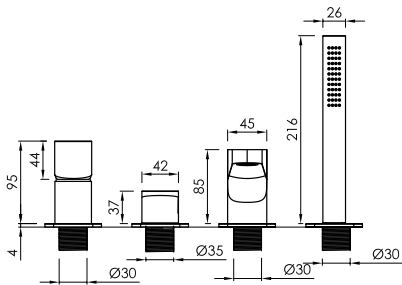

mm

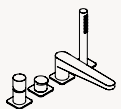

CR	BM
BNBB003CR	BNBB003BM
600 €	711 €

Kali



Sky



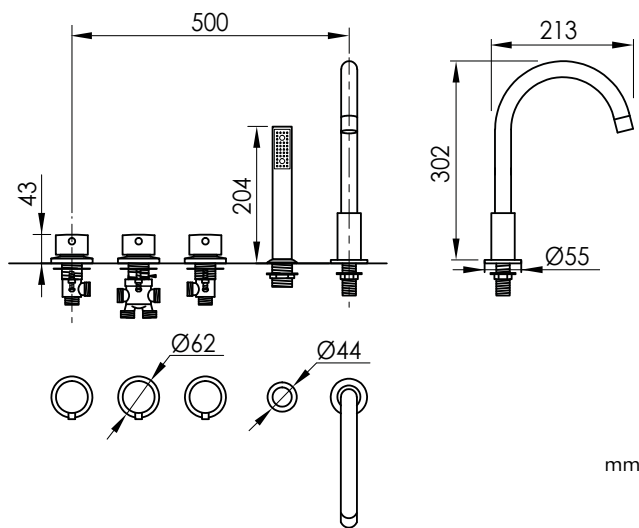

mm



Disposición 1
Mounting 1
Assemblage 1



Disposición 2
Mounting 2
Assemblage 2



Disposición 3
Mounting 3
Assemblage 3



Grifería Kali
Kali tap
Robinet Kali



BNACC188

432 €

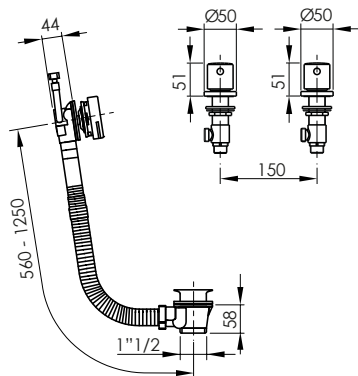

mm

Grifería repisa + desagüe con llenado
Over rim tap + waste with filling
Robinet sur plage + bonde avec remplissage par trop plein



Grifería Sky
Sky tap
Robinet Sky

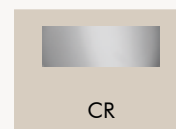

BNACC195

480 €

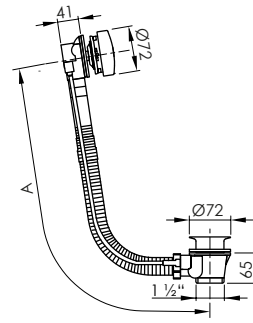

mm

A 800 mm

A 1100 mm

Desagüe automático
Waste automatic
Bonde automatique

BNACC170R

BNACC170RT

50 €

88 €

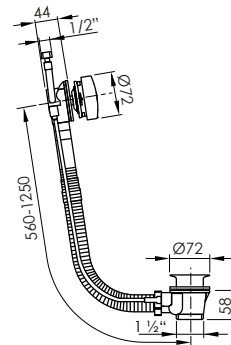

mm

Desagüe Click-Clack con llenado
Pop-up Waste with filling
Bonde Click-Clack avec remplissage

BNACC187

198 €

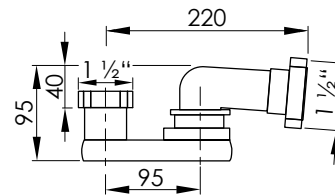

mm

Sifón
Siphon
Siphon

BNACC194

25 €

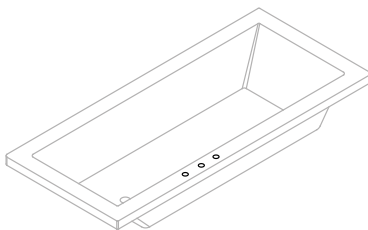

Mecanizado para grifería especial en bañera acrílica, para griferías aportadas por el cliente.
Holes for special faucet in acrylic bathtub, for taps provided by the customer.
Perçage pour robinets spéciaux baignoire acrylique, pour les robinets fournis par le client.

Mecanizado
Holes
Perçage

ACRYLMEC

66 €

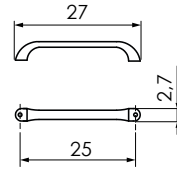

Kit 2 unidades
2 Units kit
Kit 2 unités

cm

Asas cromo
Chrome handles
Poignées chromées

BNACC206

150 €

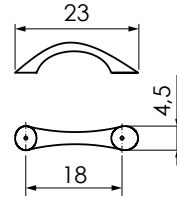

Kit 2 unidades
2 Units kit
Kit 2 unités

cm

Asas
Handles
Poignées

BNACC165

90 €

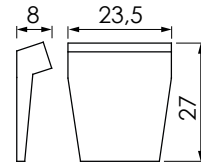

cm

Reposacabezas CN1
Headrest CN1
Repose tête CN1

BNACC161

60 €

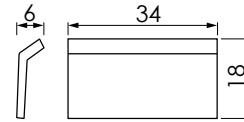

cm

Reposacabezas CN2
Headrest CN2
Repose tête CN2

BNACC162

45 €

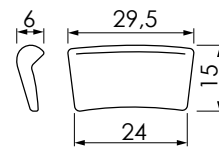

cm

Reposacabezas CN3
Headrest CN3
Repose tête CN3

BNACC163N

40 €

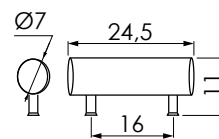

cm

Reposacabezas CN4
Headrest CN4
Repose tête CN4

BNACC164

90 €



Tratamiento antideslizante sanygrip p. 516
 sanygrip anti-slip treatment p. 516
 Traitement anti-glisserment sanygrip p. 516

sanygrip sanitaryacrylic

SGBN001

165 €

sanygrip Solid Sanycces®

SGBN002

198 €



4 m, Fittings, recortable, instalación con silicona
 4 m, Fittings, cut to fit, installation with silicone
 4 m, Fittings, recoupable, installation avec silicone

Perfil ABS
 ABS profile
 Profil ABS

BNACC166

92 €



* El kit de microjets y el calefactor solo se podrán instalar en los modelos equipados con sistema Confort, T Confort, DS Confort o Elegance.

* Microjets kit and heater can only be installed in models equipped with Confort, T Confort, DS Confort or Elegance systems.

* Le kit de microjets et réchauffeur pourra seulement être installé dans les modèles où le produit est équipé d'un système Confort, T Confort, DS Confort ou Elegance.

** Los modelos Cube 190x120 y Noa deben incorporar como primer kit de microjets la referencia BNACC176 y son los únicos modelos que pueden llevar un segundo kit de microjets, usando esta vez la referencia BNACC184.

** The Cube 190x120 and Noa models must incorporate the reference BNACC176 as the first microjets kit and are the only models that can have a second kit of microjets, using the BNACC184 reference this time.

** Les modèles Cube 190x120 et Noa doivent intégrer la référence BNACC176 comme premier kit de microjets et sont les seuls modèles pouvant porter un deuxième kit de microjets, utilisant cette fois la référence BNACC184.

6 Microjets lumbares
 6 Lumbar microjets
 6 Microjets lombaires

6 Microjets lumbares + motor extra
 6 Lumbar microjets + extra pump
 6 Microjets lombaires + pompe extra

Microjets*
 Microjets*
 Microjets*

BNACC184

BNACC176

462 €

723 €



* Solamente para bañeras con equipamiento hidro
* Only for whirlpool bathtubs
* Seulement avec équipement hydro

Calefactor*
Heather*
Réchauffeur*

BNACC189

528 €



6 LEDs RGB

Cromoterapia
Cromotherapy
Chromothérapie

BNACC171

750 €



6000K

Listo para conectar a red, interruptor no incluido
Ready to connect to power supply, switch not included
Prêt à être branché sur le secteur, interrupteur non incluse

Luz LED perimetral bajo faldón
Under panel perimetral LED light
Lumière périmétrale LED, sous panneau

BNACC202

352 €

Faldones / panels / tabliers

sanitaryacrylic



Acrílico
Acrylic
Acrilique



* Los faldones acrílicos permiten cubrir un máximo de tres lados, uno largo y dos cortos

* Acrylic panels allow covering maximum three sides, one long side and two short sides

* Les tabliers acryliques permettent la couverture sur trois côtés maximum, un côté long et deux côtés courts

Faldones / panels / tabliers

Faldones acrílicos para bañeras rectangulares / Rectangular bathtubs acrylic panels / Tabliers acriliques pour baignoires rectangulaires



140X50	FALREC140	142 €
150X50	FALREC150	144 €
160X50	FALREC160	147 €
170X50	FALREC170	150 €
180X50	FALREC180	176 €
190X50	FALREC190	188 €
190X61 BN126	FALREC121190	215 €
70X50	FALLAT70	90 €
75X50	FALLAT75	95 €
80X50	FALLAT80	100 €
90X50	FALLAT90	105 €
120X61 BN126	FALLAT121120	165 €

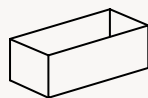
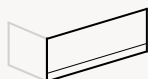

Faldón acrílico Cube 190x120 cm freestanding Freestanding Cube acrylic panel 190x120 cm Freestanding tabier acrilique Cube 190x120 cm	FAL121190120	896 €
---	--------------	-------

OP

Options

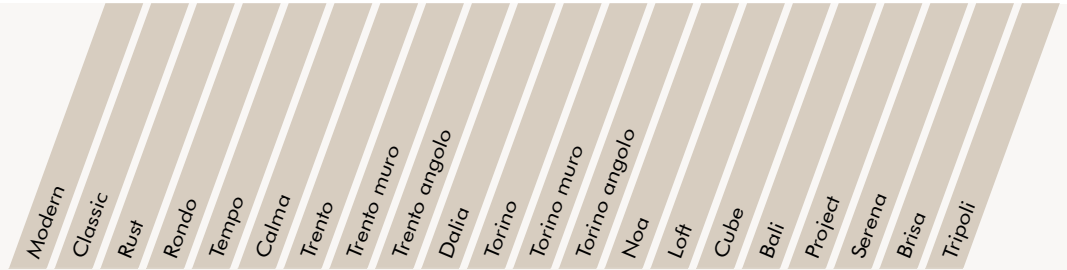

Modern
Classic
Rust
Rondo
Tempo
Calma
Trento
Trento muro
Trento angelo
Dalia
Torino
Torino muro
Torino angelo
Noa
Loft
Cubo
Bali
Project
Serena
Brisa
Tripoli

sanycoat

Lacada exterior en color
External color lacquered
Laqué de couleur exterior

Grifería de pie para bañera
Freestanding faucet for bathtub
Robinetterie sur pied pour baignoire
Loop / Loop K / Cubo / Nira



Grifería borde bañera
Deck mounted faucet for bathtub
Robinetterie au bord pour baignoire
Loop / Loop K / Cubo / Air



Grifería borde bañera
Deck mounted faucet for bathtub
Robinetterie au bord pour baignoire
Kali



Grifería Sky
Sky tap
Robinet Sky



Desagüe 80 cm
Waste
Bonde 110 cm



Desagüe con llenado
Waste with filling
Bonde avec remplissage



Sifón
Siphon
Siphon



Mecanizado SOLIDMECBN
Holes
Perçage ACRYLMEC



Asas BNACC206
Handles
Poignés BNACC165



Mistral bandeja de bañera 86x20cm
Mistral tray for freestanding bathtubs 86x20cm
Mistral plateau pour baignoire freestanding 86x20cm



Gregal bandeja portaobjetos Ø30 cm
Gregal slide tray Ø30 cm
Plateau à glissière Gregal Ø30 cm



Compatibility options-model

Compatibilidad opciones-modelo

Compatibilité des options-modèle

	Modern	Classic	Rust	Rondo	Tempo	Calma	Trento	Trento muro	Trento angulo	Dalia	Torino	Torino muro	Torino angulo	Noa	Loff	Cube	Bali	Project	Serena	Brisa	Tripoli
Reposacabezas CN1 Headrest CN1 Repose tête CN1								●								●	●				
Reposacabezas CN2 Headrest CN2 Repose tête CN2								●								●	●				
Reposacabezas CN3 Headrest CN3 Repose tête CN3										●	●	●	●	●				●	●	●	●
Reposacabezas CN4 Headrest CN4 Repose tête CN4														●	●		●		●	●	●
sanygrip	●	●	●	●	●	●	●	●	●	●	●	●	●	●	●	●	●	●	●	●	●
Microjets* BNACC184														●	●	●	●	●	●	●	●
Microjets* BNACC176**														●							
Calefactor* Heather* Réchauffeur*														●	●	●	●	●	●	●	●
Cromoterapia Cromotherapy Chromothérapie							●	●		●	●	●	●	●	●	●	●	●	●	●	●
Luz LED perimetral Perimetral LED light Lumière périmétrale LED						●			●	●											
Faldones rectangulares Rectangular panels Tabliers rectangulaires																●	●	●	●		
Faldones bañeras especiales Special panels Tabliers spéciaux														●	●					●	●

Options

* El kit de microjets y el calefactor solo se podrán instalar en los modelos equipados con sistema Confort, T Confort, DS Confort o Elegance.

** Los modelos Cube 190x120 y Noa deben incorporar como primer kit de microjets la referencia BNACC176 y son los únicos modelos que pueden llevar un segundo kit de microjets, usando esta vez la referencia BNACC184.

* Microjets kit and heater can only be installed in models equipped with Confort, T Confort, DS Confort or Elegance systems.

** The Cube 190x120 and Noa models must incorporate the reference BNACC176 as the first microjets kit and are the only models that can have a second kit of microjets, using the BNACC184 reference this time.

* Le kit de microjets et réchauffeur pourra seulement être installé dans les modèles où le produit est équipé d'un système Confort, T Confort, DS Confort ou Elegance.

** Les modèles Cube 190x120 et Noa doivent intégrer la référence BNACC176 comme premier kit de microjets et sont les seuls modèles pouvant porter un deuxième kit de microjets, utilisant cette fois la référence BNACC184.

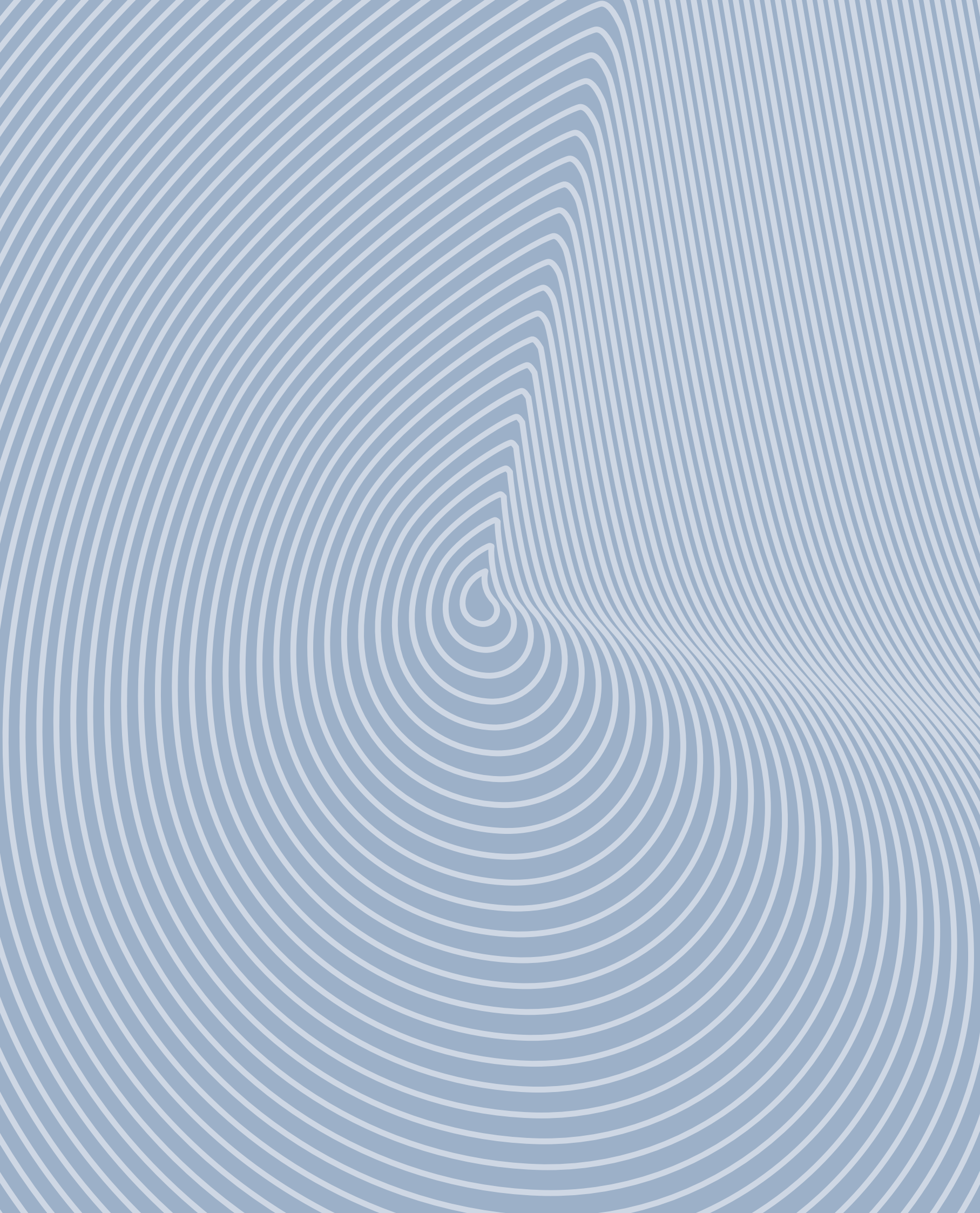

Hot tubs

Spas

Spas



Hot tubs

Hot tubs

Spas

Spas

Mikonos

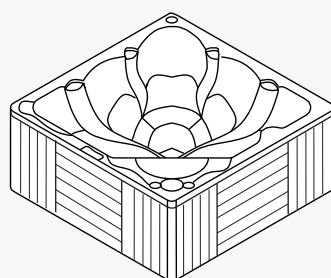

p. 218

Delos

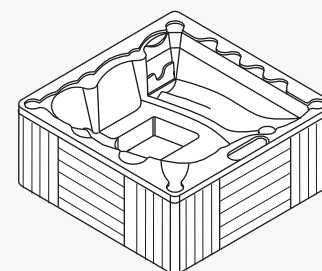

p. 220

Mikonos

213x213x89h

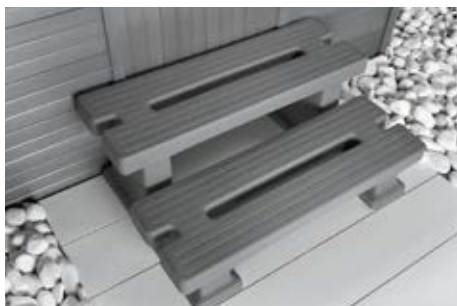

Escalera incluida
Stairs included
Inclus escalier



Cubierta isotérmica incluida
Isothermic cover included
Incluse couverture isothermique



Delos

199x199x82h

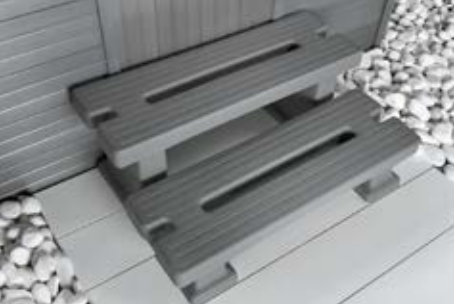

Escalera incluida
Stairs included
Inclus escalier



Cubierta isotérmica incluida
Isothermic cover included
Incluse couverture isothermique



Mikonos

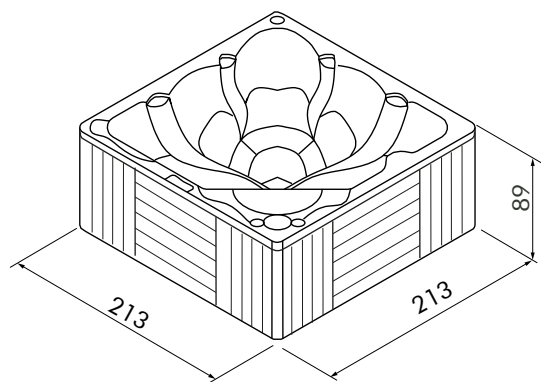

Delos

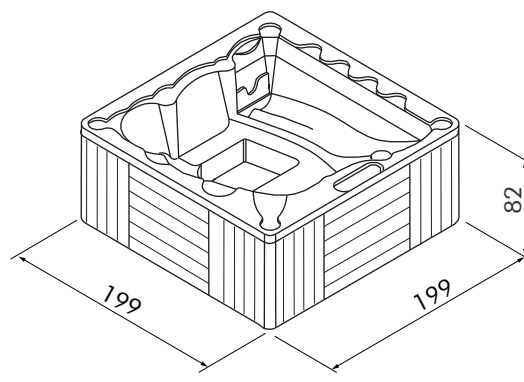

Equipamiento de serie Standard equipments Équipements standard	Delos	Mikonos	Características técnicas Technical data Caractéristiques techniques	Delos	Mikonos
Protector de cubierta Protectiv cover Couverture de protection	●	●	U(V)	230	230
Ozono Ozone Ozone	●	●	P(Kw)	4.5	6.4
Filtración programable Programmable filter Filtration programmable	●	●	I(A)	20	30
Jets multifunción Multifunction jets Jets multifonctions	21	51	f(Hz)	50	50
Reposacabezas Headrest Repose-tête	1	3	S(m ²)	4	4.54
Foco Spotlight Spot	1	1	W ₀ (Kg)	260	300
Cromoterapia Chromotherapy Chromothérapie	-	●	C _{H₂O} (L)	1240	1600
Cascada Waterfall Cascade	-	1	W _{TOTAL} (Kg)	1500	1800
Revestimiento aislante Insulative coating Revêtement isolant	●	●	W/S(Kg/ m ²)	375	392
Recirculación Recirculation Recirculation	●	●	Bomba hidro Whirlpool pump Pompe hydraulique	1 (2V*) *V _i : low Recirculación Recirculation Recirculation *V _j : high Hidromasaje Whirlpool Balneo	2
Desviador Deviator Inverseur	1	1	Bomba recirculación Recirculation pump Pompe de recirculation	-	1
Controlador de aire Air controller Contrôleur d'air	2	4	Calefactor Heater Chauffage	1	1
Regulador cascada Waterfall regulator Régulateur de cascade	-	1	Conexión Connection Connexion	mono	mono
Filtros Filters Filtres	1	1			

Spa / Hot tub / Spa

	SPA409
Mikonos	13.250 €
	SPA407
Delos	11.000 €



Hot tubs

Preguntas frecuentes

¿Dónde voy a ubicar mi Spa?

- a) En exterior: Nuestros Spas están ideados para permanecer en exteriores con materiales resistentes a las inclemencias meteorológicas.
- b) En interior muy ventilado: Con una ventilación adecuada se puede instalar en interiores. **IMPORTANTE:** ¿Cabe el Spa por la puerta?
- c) En interior poco ventilado: Se desaconseja, pues un Spa genera mucha humedad a elevada temperatura que puede afectar a los acabados de los interiores. **IMPORTANTE:** ¿Cabe el Spa por la puerta?

¿Sobre que superficie voy a ubicar mi Spa?

- a) Bien nivelado: Hormigón, pavimento cerámico, o similar.
- b) Césped: Si el terreno está bien compactado y nivelado no hay problema, pero es preferible una superficie dura y nivelada.
- c) Grava: Bien compactada y nivelada, pero es preferible nivelar la superficie con hormigón o losas.

¿Qué instalación eléctrica necesita mi Spa?

- 1) Una toma de corriente individual conectada a la puesta a tierra de la instalación, que soporte la potencia requerida por el Spa.
- 2) La sección del cable de alimentación del Spa, no será inferior a 2.5 mm².
- 3) Protección mediante un interruptor diferencial de 30mA y un magnetotérmico que sea adecuado para la potencia del Spa.

¿Qué precauciones eléctricas debo tener?

- 1) Situar el Spa mínimo a dos metros de cualquier enchufe o conexión eléctrica.
- 2) No conectar ningún aparato eléctrico a menos de dos metros del Spa.
- 3) La instalación eléctrica debe estar certificada para soportar la máxima potencia absorbida por el Spa y realizada por un instalador cualificado.

¿Qué instalación hidráulica necesita mi Spa?

- 1) Una toma de agua próxima al Spa con una manguera para llenarla.
- 2) Se recomienda conectar el desagüe del Spa a un sumidero mediante una llave de paso.

¿Cómo mantener en perfectas condiciones el agua de mi Spa?

- 1) Regulando el Ph: El Ph ideal para el agua del Spa se situará entre 7.2 y 7.8.
- 2) Regulando el Bromo: Los niveles de bromo residual deben estar entre 3 y 6 ppm.
- 3) Para controlar estos parámetros cuenta con nuestro kit de mantenimiento y de análisis del agua.

¿Cómo debo llenar mi Spa?

- 1) El Spa debe estar desconectado de la red eléctrica cuando vaya a llenarse y se debe llenar siempre con agua a temperatura ambiente.
- 2) Retire la tapa del skimer y extraiga el filtro.
- 3) Conecte una manguera a la toma de agua y llene el Spa a través del hueco que ha dejado el filtro.

¿Cuántas veces debo renovar el agua de mi Spa?

- 1) Realizando un mantenimiento correcto del agua del Spa, se calcula renovarla una o dos veces al año.
- 2) El tiempo entre las renovaciones de agua estará sujeto al uso del Spa.
- 3) Controlando el Ph y el Bromo de tu Spa será suficiente para asegurar que el agua está en condiciones óptimas.

¿Cómo debo vaciar mi Spa?

- 1) El primer paso es desconectar el Spa de la red eléctrica.
- 2) El Spa posee un desagüe en una de las esquinas exteriores en la parte inferior, ábralo.
- 3) Si has instalado el Spa conectando el desagüe de éste, a un sumidero mediante una llave de paso, como se recomienda, abre la llave de paso y tu Spa se vaciará.

¿Cómo salvar barreras arquitectónicas para ubicar mi Spa?

- a) Sortear una valla: Con la pluma de un camión de transporte debería ser suficiente.
- b) Elevar a un primer piso: Deberá contar con la intervención de un camión grúa.
- c) Sortear un edificio, elevar hasta un ático: Será necesaria la intervención de una grúa de grandes dimensiones.

¿Cómo puedo tener mi Spa en perfecto estado?

- 1) No sitúes el Spa cerca de árboles o focos de polvo. Las hojas podrían embozar el filtro y el polvo estropear la calidad del agua.
- 2) Tapa siempre el Spa con la cubierta isotérmica cuando no lo uses. Supone un ahorro energético e impide que los rayos del sol deterioren el interior del mismo, sobretudo en el caso de estar vacío.
- 3) El Spa está diseñado para contener agua a elevada temperatura, no programes una temperatura inferior a la temperatura ambiente puesto que el Spa nunca la alcanzará y puede ser perjudicial.

¿Cómo puedo mantener limpio mi Spa?

- 1) Utilizar detergentes líquidos y agua, con una esponja blanda.
- 2) Nunca utilices detergentes abrasivos, alcohol, acetona u otros disolventes.
- 3) No utilizar detergentes que produzcan espumas, preparados vegetales o sales de baño no solubles, ni productos no específicos para hidromasaje.

¿Bajo qué conceptos no debo usar un Spa?

- 1) En caso de embarazo, enfermedades cardiovasculares, problemas de tensión, desordenes circulatorios o diabetes, estas personas deben consultar previamente al uso del Spa con su médico.
- 2) En caso de haber consumido medicamentos, drogas o alcohol.
- 3) En el caso de niños o adultos con capacidades físicas, sensoriales o mentales reducidas deben ser acompañados o supervisadas por un adulto responsable.

Frequent questions

Where to install my spa?

- a) Outdoors: Our spas are built to be installed outdoors made with materials resistant to the inclement weather.
- b) Indoors and well ventilated: Can be installed indoors in a well ventilated room.
IMPORTANT: Are my doors bigger size than the spa?
- c) Indoors and with few ventilation: It's not a good advice, because a spa generates a lot of moisture at a high temperature which can damage the interior of the house.
IMPORTANT: Are my doors bigger size than the spa?

Which is the best surface?

- a) Leveled concrete, ceramic floor, or similar.
- b) Grass if it is well leveled and compacted, though a hard and leveled surface is much better.
- c) Gravel if it is well leveled and compacted, though a hard and leveled surface is much better.

Which is the electrical installation needed by my spa?

- a) An individual electrical outlet connected to the grounding of the electrical installation which withstands the power needed by the spa.
- b) The section of the cable which feeds the spa will not be inferior to 2,5 mm².
- c) Protection with a differential switch of 30 MA and an adequate circuit breaker for the spa power.

Which are the electrical precautions I must bear in mind?

- a) Install the spa not closer than 2m. from any plug or connection.
- b) Do not connect any electrical device closer than 2m. from the spa.
- c) The electrical installation must be certified by a qualified professional and in order to withstand the maximum input power.

Which is the water installation needed?

- a) A water hose close to the spa in order to fill it.
- b) Don't connect any electrical machine closer than 2m from the spa.
- c) The electrical installation must be certified in order to keep the

maximum power absorbed by the spa, and made by a qualified professional.

How to keep clean my spa water?

- a) Regulating the Ph (between 7,2 and 7,8).
- b) Regulating Bromine (between 3 and 6).
- c) To control these parameters you can be helped by our maintenance kit and water analyzer .

How to fill my spa?

- a) Disconnect it from the power and fill it with normal temperature water.
- b) Remove the skimmer cover and the filter.
- c) Connect a hose through the free space that the filter left when was removed.

How many times should I change water in the spa?

- a) If maintenance is correct, just once or twice per year.
- b) Depends on use.
- c) Controlling the Ph and Bromine will be enough to keep water clean.

How should I empty my spa?

- 1) Disconnect it from power.
- 2) It has a waste in a corner. Open it.
- 3) If you have installed as we advice you (with a stopcock) just open it.

How to manage with possible obstacles to install my spa?

- a) With a little crane-truck.
- b) To lift it to a first floor. With a bigger crane-truck.
- c) Lift to a 5th floor or pass over a building. With a big dimensions crane.

How can I keep my spa perfect?

- a) Don't install it under the trees or close to the dust. It can easily dirt the water.
- b) Use the isothermic cover to keep the water clean and at a good temperature. Also avoids the sun rays to damage the spa , especially if it is empty.
- c) It is designed to keep water at a certain temperature. Don't decrease temperature lower than

the air because it will never reach it and can damage the system.

How can I keep my spa clean?

- a) Use liquid detergents and water with a soft sponge.
- b) Never use abrasive detergents, alcohol, acetone or other solvents.
- c) Never use detergents which produce foam, vegetal preparations, non soluble salts, or other products non specific for the whirlpool.

When should I not use my spa?

- a) Pregnancy, heart and tension, circulation problems or diabetes. You should ask your doctor.
- b) If you have taken medicin, drugs or alcohol.
- c) Children with sensorial, mental or physical disabilities must be under supervision of an adult responsible of their safety.

Questions fréquentes

Où installer mon Spa?

- a) À l'extérieur: Nos Spas sont conçus pour rester à l'extérieur grâce aux matériaux résistants aux conditions météorologiques extrêmes.
- b) Intérieur très ventilé: Avec un bon système de ventilation, les spas peuvent être installés à l'intérieur.
IMPORTANT: Le Spa passe par la porte?.
- c) Intérieur peu ventilé: Totalemment déconseillé, car le Spa génère beaucoup d'humidité à une température élevée qui peut favoriser la dégradation des murs ou certains matériaux adjacents.
IMPORTANT: Le Spa passe par la porte?.

Sur quelle surface dois-je installer mon Spa?

- a) L'emplacement doit être bien plat, lisse et stable: Sur une dalle en béton armé, une terrasse, ou similaire.
- b) Herbe: Si le terrain est nivelé et bien compacte, il ne devrait pas y avoir de souci, néanmoins nous conseillons une surface dure et nivelée.
- c) Gravier: Bien compacts et nivelés, mais il est conseillé de niveler la surface avec du béton ou des dalles.

Avec quelle installation électrique fonctionne mon Spa?

- 1) L'alimentation électrique sera faite par un câble connecté sur un boîtier électrique relié à la terre et qui accepte la puissance nécessaire pour le fonctionnement du Spa.
- 2) La section du câble d'alimentation du Spa ne sera pas inférieure à 2.5 mm².
- 3) Protection à travers un disjoncteur différentiel de 30mA et un autre magnétothermique qui soient suffisants pour le Spa.

Quelles précautions électriques dois-je tenir?

- 1) Placez votre Spa à plus de deux mètres de toute prise ou interrupteurs électriques.
- 2) Ne pas brancher d'appareil électrique à moins de deux mètres du Spa.
- 3) L'installation électrique doit être certifiée pour accepter la puis-

sance maximale nécessaire pour le Spa et doit être effectuée par un électricien agréé.

Quelle installation hydraulique a besoin mon Spa?

- 1) Le Spa doit être proche d'une prise d'eau munie d'un tuyau d'arrosage pour le remplir.
- 2) Il est conseillé de raccorder la vidage du Spa au système d'égout de la propriété et d'installer un robinet d'arrêt.

Comment maintenir l'eau de mon Spa en bonnes conditions?

- 1) Ajuster le Ph: Le Ph idéal de l'eau du Spa se situe entre 7.2 et 7.8.
- 2) Maintenir un niveau de Brome résiduel entre 3 y 6 ppm.
- 3) Un kit de maintenance et d'analyse d'eau est inclu pour contrôler ces paramètres.

Comment dois-je remplir mon Spa?

- 1) L'alimentation électrique doit être coupée avant et pendant le remplissage du Spa. L'eau doit être à température ambiante.
- 2) Retirez le panneau d'accès du skimer et retirez le filtre.
- 3) Raccordez un tuyau d'arrosage à la prise d'eau, placez-le dans le creux du filtre et remplissez votre Spa.

Avec quelle fréquence dois-je changer l'eau du Spa?

- 1) Si l'entretien de l'eau est fait correctement, il est possible de changer l'eau une ou deux fois par an.
- 2) La fréquence dépendra de l'utilisation du spa.
- 3) Le contrôle du Ph et du Brome est suffisant pour garantir que l'eau soit dans les meilleures conditions.

Comment dois-je vider mon Spa?

- 1) Avant tout, débrancher tous les circuits d'alimentation de votre Spa.
- 2) Localisez la valve de purge dans un des coins extérieurs sur la partie inférieure et ouvrez-la.
- 3) Si, suivant notre conseil, la vidange du Spa est connectée au système d'égout, il suffira d'ouvrir le robinet d'arrêt pour le vider.

Comment puis-je surmonter les barrières architectoniques pour installer mon Spa?

- a) Passer une clôture: Un camion muni d'une flèche télescopique devrait suffire.
- b) Monter à un premier étage: La livraison devra être effectuée par un camion grue.
- c) Surmonter un bâtiment ou l'élever jusqu'au dernier étage: L'intervention d'un camion grue de grande dimension sera nécessaire.

Comment conserver mon Spa en parfait état?

- 1) Veillez à ne pas mettre votre Spa auprès d'arbres ou autres zones spot de poussières. Les feuilles pourraient boucher le filtre et abîmer la qualité de l'eau.
- 2) Utiliser la couverture isothermique pour couvrir le Spa quand il n'est pas en marche, cela suppose une grande économie d'énergie et protégera votre Spa des rayons U.V qui détériorent son intérieur, surtout quand il est vide.
- 3) Le Spa est conçu pour contenir de l'eau à une température élevée, merci de ne pas programmer votre Spa avec une température inférieure à la température ambiante car le Spa ne pourra pas l'atteindre et cela pourrait nuire au bon fonctionnement de votre Spa.

Que dois-je faire pour maintenir mon Spa propre?

- 1) Utiliser une éponge non abrasive avec un nettoyant et de l'eau.
- 2) Il est déconseillé d'utiliser des nettoyants abrasifs, de l'alcool ou des solvants.
- 3) Il est déconseillé d'utiliser des détergents moussants, des huiles végétales ou des sels de bain non solubles, ni d'autres produits qui soient pas conçus pour les hydromassages.

Dans quel cas je ne devrais pas utiliser le Spa?

- 1) Les personnes ayant des antécédents de maladie cardiaque, des problèmes de tension artérielle, des problèmes du système circulatoire ou de diabète, ainsi que les femmes enceintes doivent consulter un médecin avant de l'utiliser.

- 2) En cas d'avoir consommée de drogues, médicaments ou alcool
- 3) Les enfants ou les personnes avec des limitations physiques, sensorielles ou mentales doivent être accompagnées et surveillées par un adulte responsable.



Hot tubs

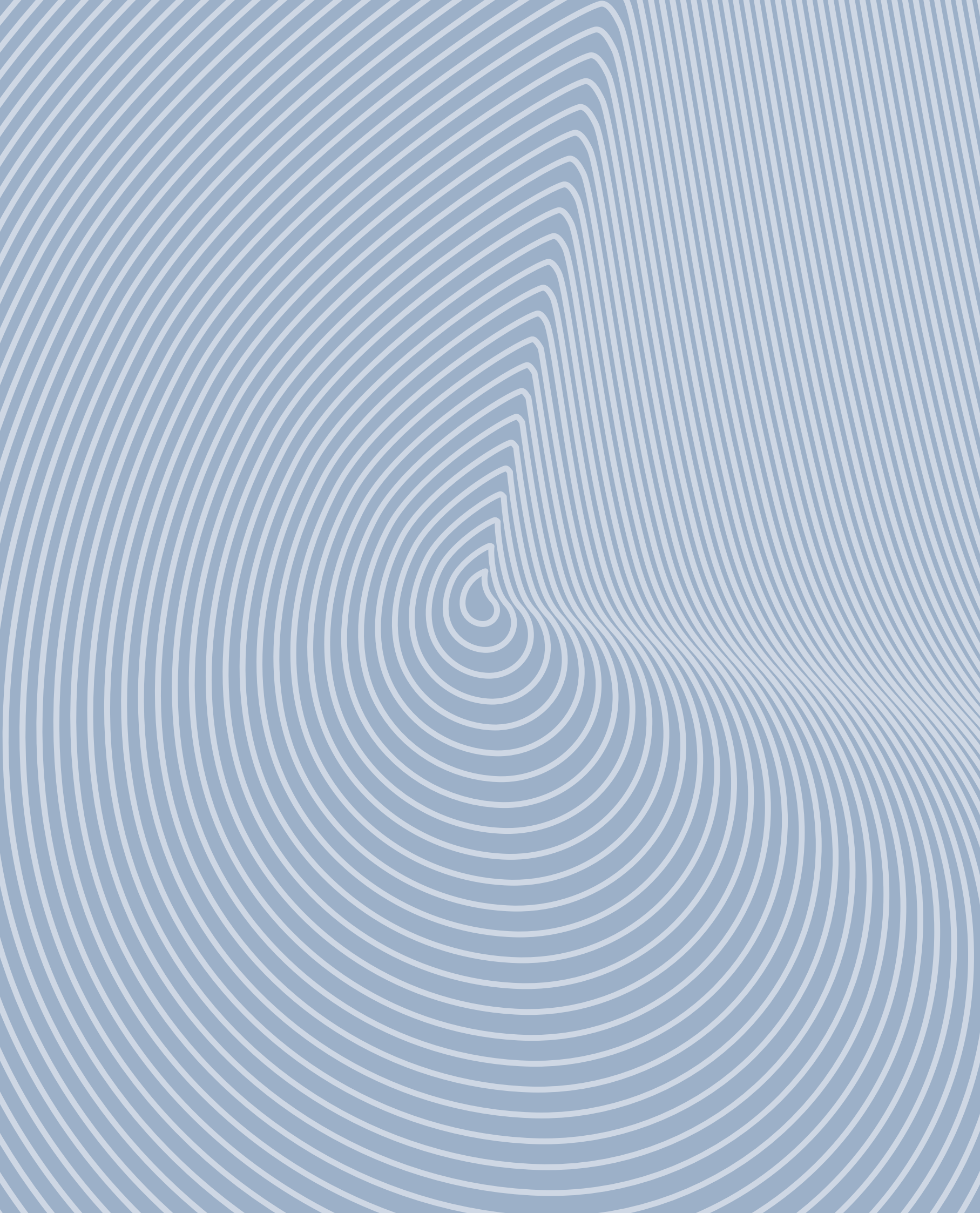

Shower trays

Platos de ducha

Receveurs

sanydur gel coat

Clever

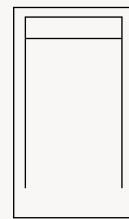

p. 234

Strato

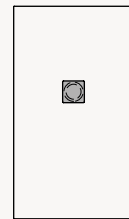
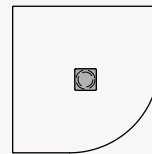

p. 240

Shower trays

Platos de ducha

Receveurs

sanylite gel coat

New York

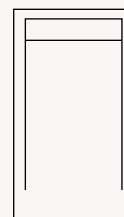

p. 254

Logic

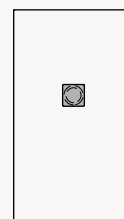
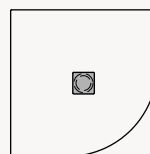

p. 260

Logic marco

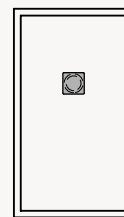
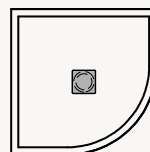

p. 266

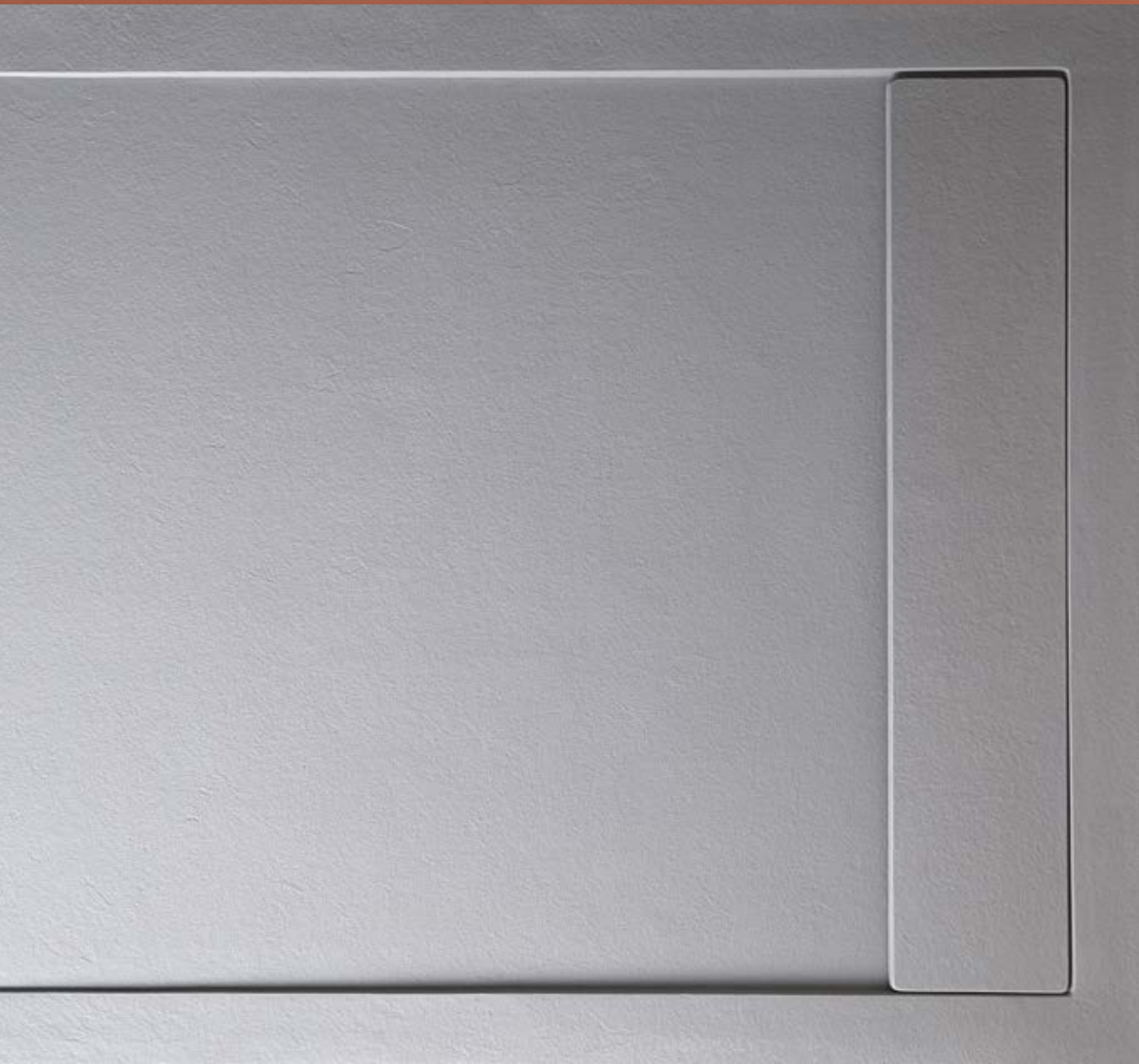

sanydur



Clever

sanydur gel coat slate



Antideslizante Clase III
Anti-slip Class III
Antidérapant Class III



Incluye rejilla sanydur gel coat
Sanydur gel coat grate included
Comprend grille en sanydur gel coat

+ Clever series



Lavabo
Washbasin
Vasque





scandur

— Clever 120x90 anthracite

Cappuccino NCS 6010 – Y30R

Cream RAL1013

White RAL9016

Anthracite RAL7016

Les couleurs des photos peuvent être légèrement différentes. Pour une meilleure identification de la couleur, consultez les nuanciers RAL ou NCS.

Concrete RAL7030

The colors of the photographs are not binding, for a better identification of the color, consult RAL or NCS card.

Light concrete RAL7035

Los colores de las fotografías no son vinculantes, para una mejor identificación del color, consultar carta RAL o NCS.

Elephant grey NCS 5005 – Y50R

Clever

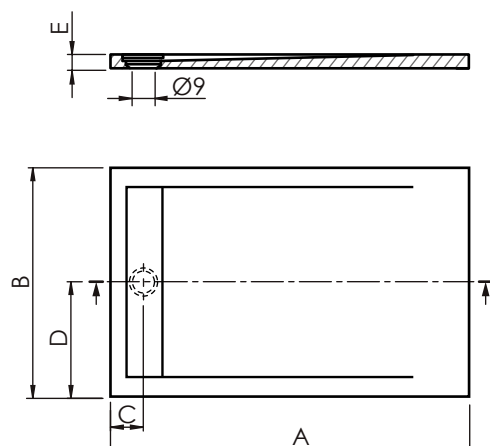

dim.cm	A	B	C	D	E
100x70	100	70	12	35	4
120x70	120	70	12	35	4
140x70	140	70	12	35	4
160x70	160	70	12	35	4
180x70	180	70	12	35	4
210x70	210	70	12	35	4
100x80	100	80	12	40	4
120x80	120	80	12	40	4
140x80	140	80	12	40	4
160x80	160	80	12	40	4
180x80	180	80	12	40	4
210x80	210	80	12	40	4
100x90	100	90	12	45	4
120x90	120	90	12	45	4
140x90	140	90	12	45	4
160x90	160	90	12	45	4
180x90	180	90	12	45	4
210x90	210	90	12	45	4
100x100	100	100	12	50	4
120x100	120	100	12	50	4
140x100	140	100	12	50	4
160x100	160	100	12	50	4
180x100	180	100	12	50	4
210x100	210	100	12	50	4

Accesorios / Accessories / Accessoires



Desagüe Ø90 h74 mm
Waste Ø90 h74 mm
Bonde Ø90 h74 mm

ACC655

33 €



Desagüe vertical Ø90 h100 mm
Vertical waste Ø90 h100 mm
Bonde verticale Ø90 h100 mm

ACC656

38 €









Desagüe extraplano Ø90 h53 mm
Superslim waste Ø90 h53 mm
Bonde superslim Ø90 h53 mm

ACC657

39 €

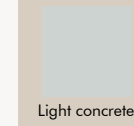
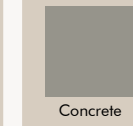
Plato de ducha / Shower tray / Receveur de douche

	 White	 Cream	 Cappuccino	 Elephant grey	 Light concrete	 Concrete	 Anthracite	
100x70	PL92010070	PL92110070	PL92210070	PL92310070	PL92410070	PL92510070	PL92610070	504 €
120x70	PL92012070	PL92112070	PL92212070	PL92312070	PL92412070	PL92512070	PL92612070	583 €
140x70	PL92014070	PL92114070	PL92214070	PL92314070	PL92414070	PL92514070	PL92614070	659 €
160x70	PL92016070	PL92116070	PL92216070	PL92316070	PL92416070	PL92516070	PL92616070	748 €
180x70	PL92018070	PL92118070	PL92218070	PL92318070	PL92418070	PL92518070	PL92618070	818 €
210x70	PL92021070	PL92121070	PL92221070	PL92321070	PL92421070	PL92521070	PL92621070	938 €
100x80	PL92010080	PL92110080	PL92210080	PL92310080	PL92410080	PL92510080	PL92610080	530 €
120x80	PL92012080	PL92112080	PL92212080	PL92312080	PL92412080	PL92512080	PL92612080	610 €
140x80	PL92014080	PL92114080	PL92214080	PL92314080	PL92414080	PL92514080	PL92614080	713 €
160x80	PL92016080	PL92116080	PL92216080	PL92316080	PL92416080	PL92516080	PL92616080	814 €
180x80	PL92018080	PL92118080	PL92218080	PL92318080	PL92418080	PL92518080	PL92618080	867 €
210x80	PL92021080	PL92121080	PL92221080	PL92321080	PL92421080	PL92521080	PL92621080	1.044 €
100x90	PL92010090	PL92110090	PL92210090	PL92310090	PL92410090	PL92510090	PL92610090	610 €
120x90	PL92012090	PL92112090	PL92212090	PL92312090	PL92412090	PL92512090	PL92612090	668 €
140x90	PL92014090	PL92114090	PL92214090	PL92314090	PL92414090	PL92514090	PL92614090	787 €
160x90	PL92016090	PL92116090	PL92216090	PL92316090	PL92416090	PL92516090	PL92616090	938 €
180x90	PL92018090	PL92118090	PL92218090	PL92318090	PL92418090	PL92518090	PL92618090	1.031 €
210x90	PL92021090	PL92121090	PL92221090	PL92321090	PL92421090	PL92521090	PL92621090	1.164 €
100x100	PL920100100	PL921100100	PL922100100	PL923100100	PL924100100	PL925100100	PL926100100	624 €
120x100	PL920120100	PL921120100	PL922120100	PL923120100	PL924120100	PL925120100	PL926120100	726 €
140x100	PL920140100	PL921140100	PL922140100	PL923140100	PL924140100	PL925140100	PL926140100	810 €
160x100	PL920160100	PL921160100	PL922160100	PL923160100	PL924160100	PL925160100	PL926160100	938 €
180x100	PL920180100	PL921180100	PL922180100	PL923180100	PL924180100	PL925180100	PL926180100	1.063 €
210x100	PL920210100	PL921210100	PL922210100	PL923210100	PL924210100	PL925210100	PL926210100	1.209 €



100x70	*
120x70	*
140x70	*
160x70	*
180x70	*
210x70	*
100x80	*
120x80	*
140x80	*
160x80	*
180x80	*
210x80	*
100x90	*
120x90	*
140x90	*
160x90	*
180x90	*
210x90	*
100x100	*
120x100	*
140x100	*
160x100	*
180x100	*
210x100	*



CP10070RAL	630 €
CP12070RAL	720 €
CP14070RAL	815 €
CP16070RAL	925 €
CP18070RAL	1.010 €
CP21070RAL	1.160 €
CP10080RAL	655 €
CP12080RAL	755 €
CP14080RAL	880 €
CP16080RAL	1.005 €
CP18080RAL	1.070 €
CP21080RAL	1.290 €
CP10090RAL	755 €
CP12090RAL	825 €
CP14090RAL	975 €
CP16090RAL	1.160 €
CP18090RAL	1.275 €
CP21090RAL	1.440 €
CP100100RAL	770 €
CP120100RAL	895 €
CP140100RAL	1.000 €
CP160100RAL	1.160 €
CP180100RAL	1.315 €
CP210100RAL	1.495 €

* Especificar el RAL en pedido.

* Specify the RAL in the order.

* Spécifiez le RAL dans l'ordre.

Strato

sanydur gel coat slate



sanysize



Platos de ducha a la medida
Made to measure shower trays
Receveurs sur mesure



Antideslizante Clase III
Anti-slip Class III
Antidérapant Class III



Incluye rejilla inox
Stainless steel grate included
Comprend grille en acier inoxydable

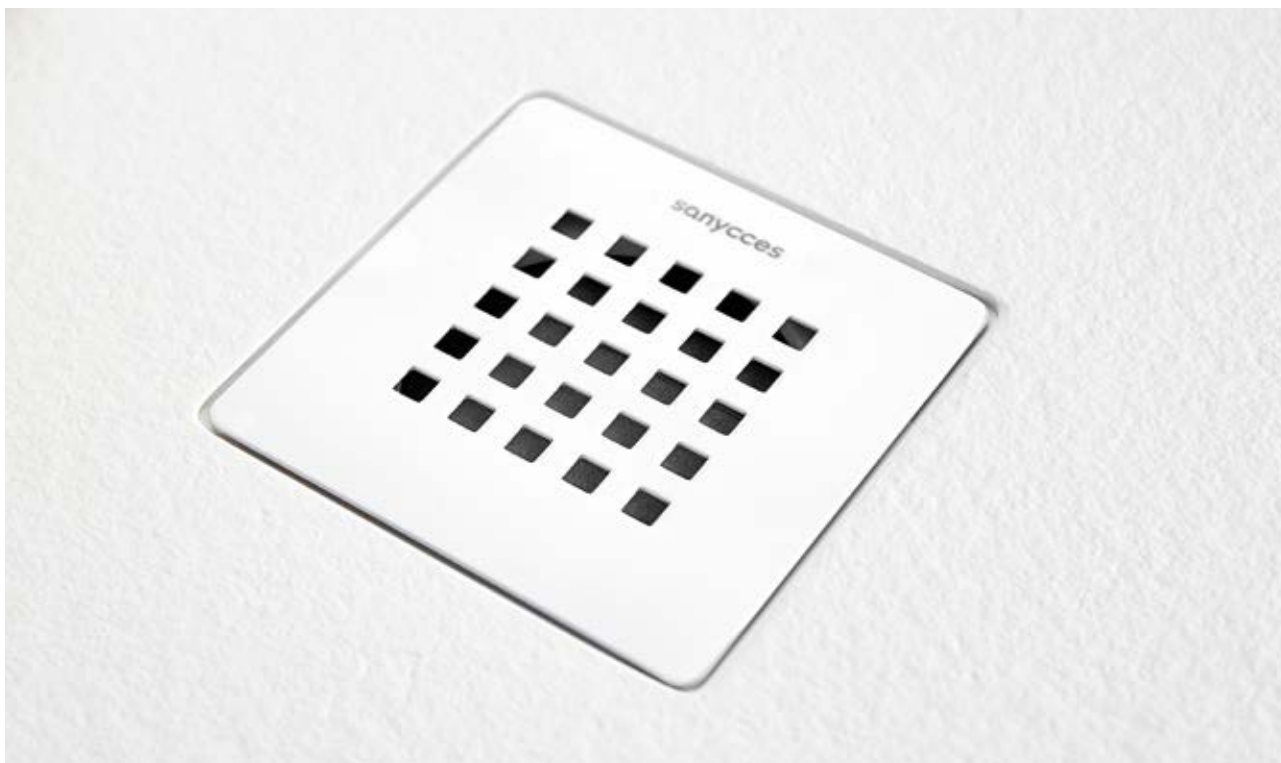



Strato 140x90 white + REJILL9003

Strato

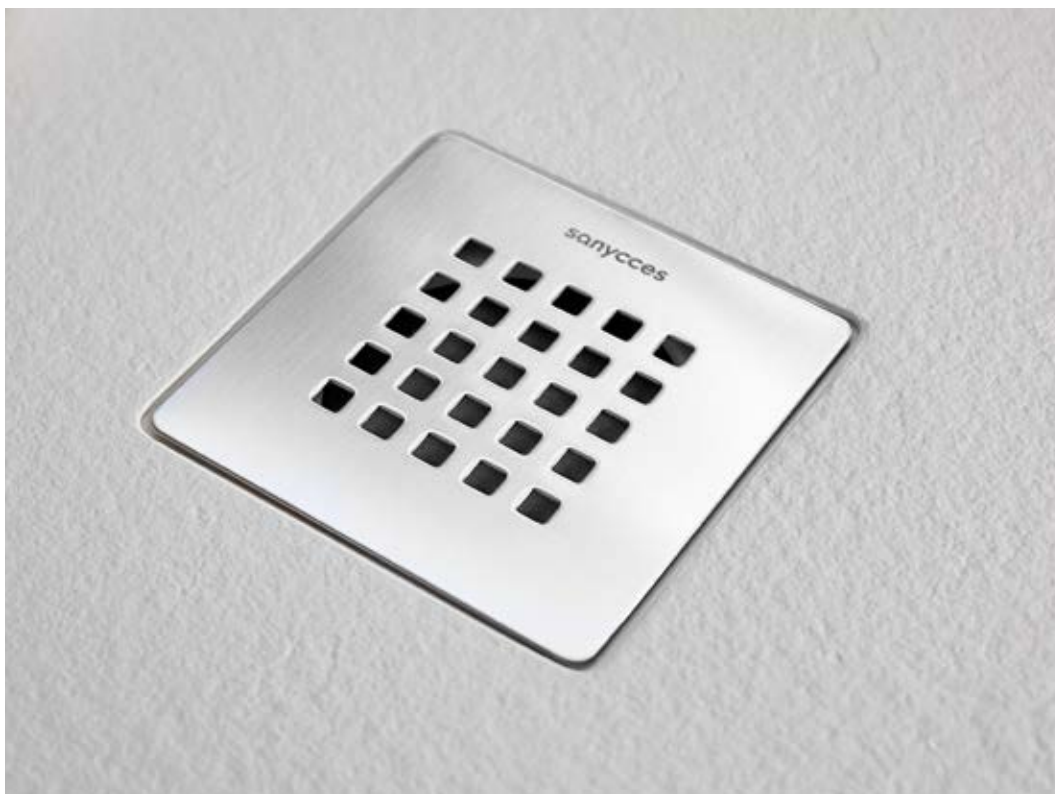



sanydur

Strato 140x90 grey

Strato



— Strato 140x90 cream +  REJILL1015



Strato 140x90 cocoa + REJILL7006

White RAL9003

Grey RAL7036

Black RAL7021

Cocoa RAL7006

Les couleurs des photos peuvent être légèrement différentes. Pour une meilleure identification de la couleur, consultez les nuanciers RAL.

Moka RAL1019

The colors of the photographs are not binding, for a better identification of the color, consult RAL card.

Sand RAL7032

Los colores de las fotografías no son vinculantes, para una mejor identificación del color, consultar carta RAL.

Cream RAL1015

Strato

rejilla color
color grate
grille en colour



White RAL9003



Grey RAL7036



Black RAL7021



Cream RAL1015



Sand RAL7032



Moka RAL1019



Cocoa RAL7006

Los colores de las fotografías no son vinculantes,
para una mejor identificación del color, consultar
carta RAL.

The colors of the photographs are not binding,
for a better identification of the color, consult RAL
card.

Les couleurs des photos peuvent être légèrement
différentes. Pour une meilleure identification de la
couleur, consultez les nuanciers RAL.



customcut



Strato

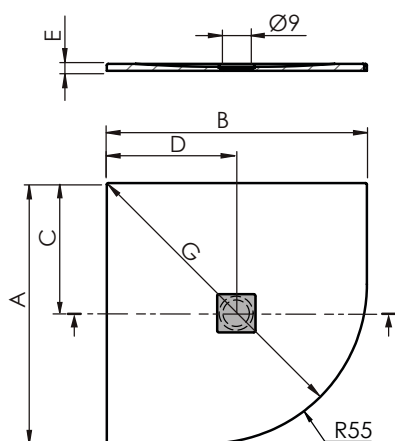

dim.cm	A	B	C	D	E
90x90	90	90	45	45	2,4

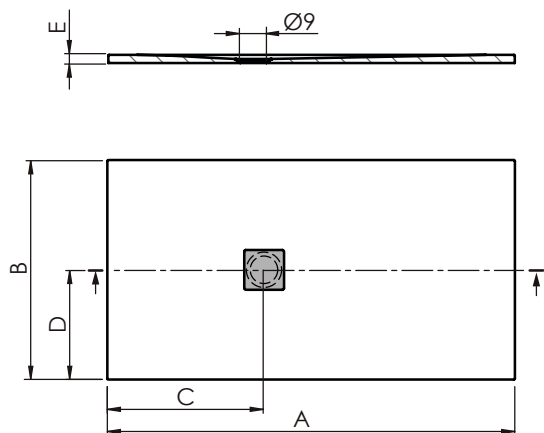

dim.cm	A	B	C	D	E
90x70	90	70	40	35	2,4
100x70	100	70	40	35	2,4
120x70	120	70	45	35	2,4
140x70	140	70	50	35	2,5
160x70	160	70	52	35	2,5
180x70	180	70	52	35	2,7
90x80	90	80	40	40	2,4
100x80	100	80	40	40	2,4
110x80	110	80	45	40	2,4
120x80	120	80	45	40	2,5
130x80	130	80	50	40	2,5
140x80	140	80	50	40	2,5
150x80	150	80	52	40	2,7
160x80	160	80	52	40	2,7
170x80	170	80	52	40	2,7
180x80	180	80	52	40	2,7
190x80	190	80	52	40	2,7
90x90	90	90	40	45	2,4
100x90	100	90	45	45	2,4
120x90	120	90	45	45	2,4
140x90	140	90	50	45	2,5
160x90	160	90	52	45	2,7
180x90	180	90	52	45	2,7
140x100	140	100	50	50	2,7
160x100	160	100	50	50	2,7
180x100	180	100	50	50	2,7

Plato de ducha / Shower tray / Receveur de douche



r= 55cm

90x90	PL9039090SB	PL9039090SG	PL9039090SN	PL9039090SBE	PL9039090SSA	PL9039090SMO	PL9039090SCO	346 €
90x70	PL9039070B	PL9039070G	PL9039070N	PL9039070BE	PL9039070SA	PL9039070MO	PL9039070CO	249 €
100x70	PL90310070B	PL90310070G	PL90310070N	PL90310070BE	PL90310070SA	PL90310070MO	PL90310070CO	251 €
120x70	PL90312070B	PL90312070G	PL90312070N	PL90312070BE	PL90312070SA	PL90312070MO	PL90312070CO	315 €
140x70	PL90314070B	PL90314070G	PL90314070N	PL90314070BE	PL90314070SA	PL90314070MO	PL90314070CO	370 €
160x70	PL90316070B	PL90316070G	PL90316070N	PL90316070BE	PL90316070SA	PL90316070MO	PL90316070CO	436 €
180x70	PL90318070B	PL90318070G	PL90318070N	PL90318070BE	PL90318070SA	PL90318070MO	PL90318070CO	514 €
90x80	PL9039080B	PL9039080G	PL9039080N	PL9039080BE	PL9039080SA	PL9039080MO	PL9039080CO	271 €
100x80	PL90310080B	PL90310080G	PL90310080N	PL90310080BE	PL90310080SA	PL90310080MO	PL90310080CO	288 €
110x80	PL90311080B	PL90311080G	PL90311080N	PL90311080BE	PL90311080SA	PL90311080MO	PL90311080CO	343 €
120x80	PL90312080B	PL90312080G	PL90312080N	PL90312080BE	PL90312080SA	PL90312080MO	PL90312080CO	359 €
130x80	PL90313080B	PL90313080G	PL90313080N	PL90313080BE	PL90313080SA	PL90313080MO	PL90313080CO	408 €
140x80	PL90314080B	PL90314080G	PL90314080N	PL90314080BE	PL90314080SA	PL90314080MO	PL90314080CO	421 €
150x80	PL90315080B	PL90315080G	PL90315080N	PL90315080BE	PL90315080SA	PL90315080MO	PL90315080CO	450 €
160x80	PL90316080B	PL90316080G	PL90316080N	PL90316080BE	PL90316080SA	PL90316080MO	PL90316080CO	505 €
170x80	PL90317080B	PL90317080G	PL90317080N	PL90317080BE	PL90317080SA	PL90317080MO	PL90317080CO	558 €
180x80	PL90318080B	PL90318080G	PL90318080N	PL90318080BE	PL90318080SA	PL90318080MO	PL90318080CO	591 €
190x80	PL90319080B	PL90319080G	PL90319080N	PL90319080BE	PL90319080SA	PL90319080MO	PL90319080CO	642 €
90x90	PL9039090B	PL9039090G	PL9039090N	PL9039090BE	PL9039090SA	PL9039090MO	PL9039090CO	292 €
100x90	PL90310090B	PL90310090G	PL90310090N	PL90310090BE	PL90310090SA	PL90310090MO	PL90310090CO	317 €
120x90	PL90312090B	PL90312090G	PL90312090N	PL90312090BE	PL90312090SA	PL90312090MO	PL90312090CO	397 €
140x90	PL90314090B	PL90314090G	PL90314090N	PL90314090BE	PL90314090SA	PL90314090MO	PL90314090CO	463 €
160x90	PL90316090B	PL90316090G	PL90316090N	PL90316090BE	PL90316090SA	PL90316090MO	PL90316090CO	557 €
180x90	PL90318090B	PL90318090G	PL90318090N	PL90318090BE	PL90318090SA	PL90318090MO	PL90318090CO	654 €
140x100	PL903140100B	PL903140100G	PL903140100N	PL903140100BE	PL903140100SA	PL903140100MO	PL903140100CO	493 €
160x100	PL903160100B	PL903160100G	PL903160100N	PL903160100BE	PL903160100SA	PL903160100MO	PL903160100CO	604 €
180x100	PL903180100B	PL903180100G	PL903180100N	PL903180100BE	PL903180100SA	PL903180100MO	PL903180100CO	669 €



Opciones / Options / Options



Corte a la medida
Cut to fit
Coupe sur mesure

CORTE

55 €

Accesorios / Accessories / Accessoires



rejilla color
color grate
grille en colour

REJILL1015	REJILL7032	REJILL1019	REJILL7006
REJILL9003	REJILL7036	REJILL7021	33 €



Desagüe Ø90 h74 mm
Waste Ø90 h74 mm
Bonde Ø90 h74 mm

ACC655

33 €



Desagüe vertical Ø90 h100 mm
Vertical waste Ø90 h100 mm
Bonde verticale Ø90 h100 mm

ACC656

38 €



Desagüe extraplano Ø90 h53 mm
Superslim waste Ø90 h53 mm
Bonde superslim Ø90 h53 mm

ACC657

39 €



sanylite

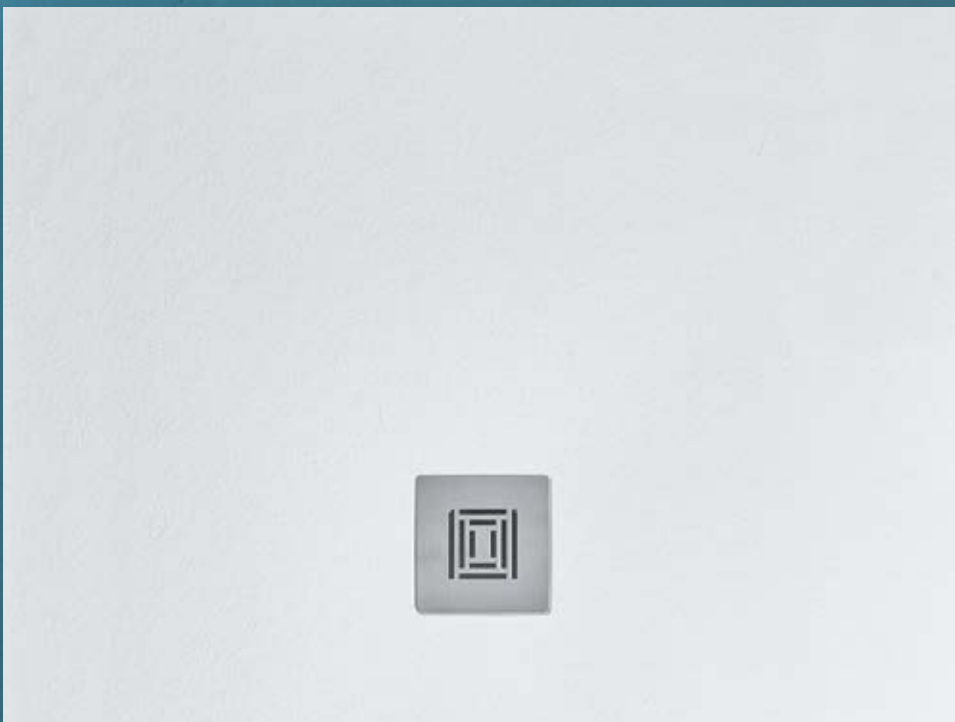

New York

sanylite gel coat slate



Antideslizante Clase III
Anti-slip Class III
Antidérapant Class III



Incluye rejilla sanylite gel coat
Sanylite gel coat grate included
Comprend grille en sanylite gel coat



← New York grey 120x90



⇒ New York white 120x90

New York



Blanco / White / Blanc
RAL9003



Gris / Grey / Gris
RAL7036

Los colores de las fotografías no son vinculantes,
para una mejor identificación del color, consultar
carta RAL.

The colors of the photographs are not binding,
for a better identification of the color, consult RAL
card.

Les couleurs des photos peuvent être légèrement
différentes. Pour une meilleure identification de la
couleur, consultez les nuanciers RAL.



Negro / Black / Noir
RAL7021

New York

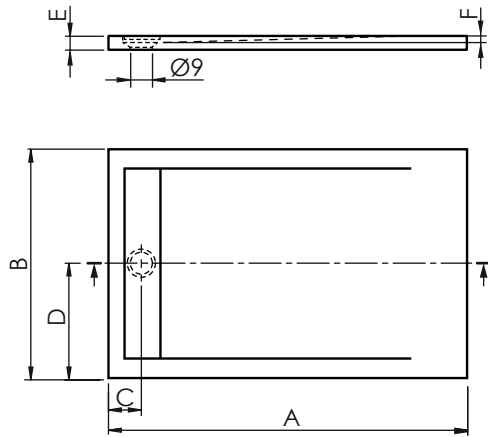

dim.cm	A	B	C	D	E	F
90x70	90	70	12,5	35	4,5	2,5
100x70	100	70	12,5	35	4,5	2,5
120x70	120	70	12,5	35	4,5	2,5
140x70	140	70	12,5	35	4,5	2,5
160x70	160	70	12,5	35	4,5	2,5
170x70	170	70	12,5	35	4,5	2,5
100x80	100	80	12,5	40	4,5	2,5
120x80	120	80	12,5	40	4,5	2,5
140x80	140	80	12,5	40	4,5	2,5
160x80	160	80	12,5	40	4,5	2,5
100x90	100	90	12,5	45	4,5	2,5
120x90	120	90	12,5	45	4,5	2,5
140x90	140	90	12,5	45	4,5	2,5
160x90	160	90	12,5	45	4,5	2,5

Plato de ducha / Shower tray / Receveur de douche

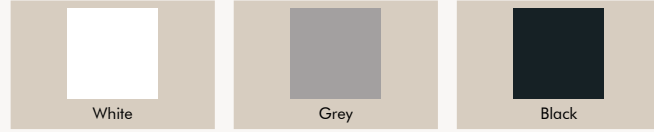

	White	Grey	Black	
90x70	PL9089070B	PL9089070G	PL9089070N	232 €
100x70	PL90810070B	PL90810070G	PL90810070N	238 €
120x70	PL90812070B	PL90812070G	PL90812070N	257 €
140x70	PL90814070B	PL90814070G	PL90814070N	290 €
160x70	PL90816070B	PL90816070G	PL90816070N	344 €
170x70	PL90817070B	PL90817070G	PL90817070N	390 €
100x80	PL90810080B	PL90810080G	PL90810080N	254 €
120x80	PL90812080B	PL90812080G	PL90812080N	276 €
140x80	PL90814080B	PL90814080G	PL90814080N	314 €
160x80	PL90816080B	PL90816080G	PL90816080N	368 €
100x90	PL90810090B	PL90810090G	PL90810090N	282 €
120x90	PL90812090B	PL90812090G	PL90812090N	297 €
140x90	PL90814090B	PL90814090G	PL90814090N	337 €
160x90	PL90816090B	PL90816090G	PL90816090N	386 €

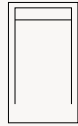

Accesorios / Accessories / Accessoires



Desagüe Ø90 h74 mm
Waste Ø90 h74 mm
Bonde Ø90 h74 mm

ACC655
33 €



Desagüe vertical Ø90 h100 mm
Vertical waste Ø90 h100 mm
Bonde verticale Ø90 h100 mm

ACC656
38 €



Desagüe extraplano Ø90 h53 mm
Superslim waste Ø90 h53 mm
Bonde superslim Ø90 h53 mm

ACC657
39 €

No admite corte

It can not be cut

Ne peut pas être coupé

Logic

sanylite slate



Antideslizante Clase III
Anti-slip Class III
Antidérapant Class III



Incluye rejilla inox
Stainless steel grate included
Comprend grille en acier inoxydable





Logic 140x90

Logic



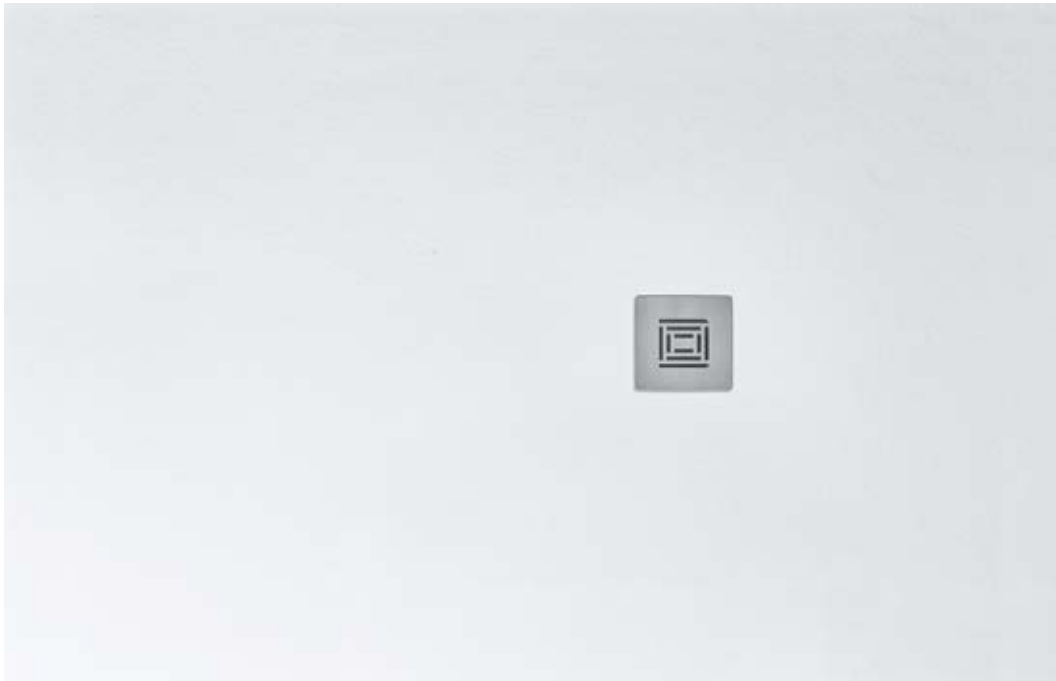

Logic

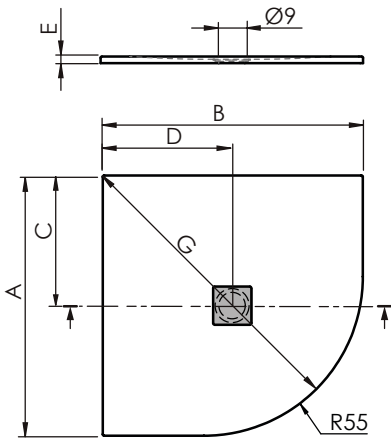

dim.cm	A	B	C	D	E
80x80	80	80	40	40	3
90x90	90	90	45	45	3

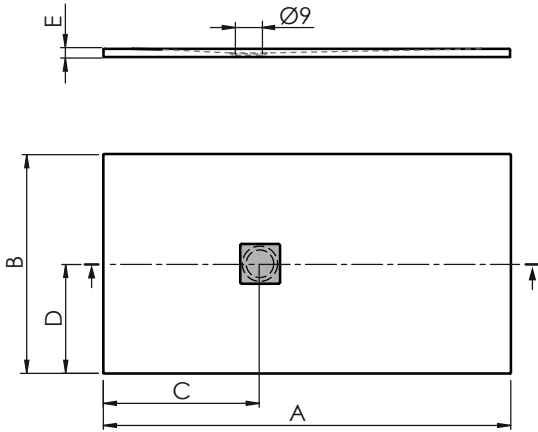

dim.cm	A	B	C	D	E
90x70	90	70	40	35	3
100x70	100	70	40	35	3
120x70	120	70	45	35	3
140x70	140	70	50	35	3
160x70	160	70	52	35	3
170x70	170	70	52	35	3
180x70	180	70	52	35	3
80x80	80	80	40	40	3
90x80	90	80	40	40	3
100x80	100	80	40	40	3
110x80	110	80	45	40	3
120x80	120	80	45	40	3
130x80	130	80	50	40	3
140x80	140	80	50	40	3
150x80	150	80	52	40	3
160x80	160	80	52	40	3
170x80	170	80	52	40	3
180x80	180	80	52	40	3
190x80	190	80	52	40	3
90x90	90	90	40	45	3
100x90	100	90	45	45	3
120x90	120	90	45	45	3
140x90	140	90	50	45	3
160x90	160	90	52	45	3
180x90	180	90	52	45	3
140x100	140	100	52	50	3
160x100	160	100	52	50	3
180x100	180	100	52	50	3

Plato de ducha / Shower tray / Receveur de douche



r= 55cm

80x80	PL9048080SB	159 €
90x90	PL9049090SB	179 €
90x70	PL9049070B	155 €
100x70	PL90410070B	159 €
120x70	PL90412070B	175 €
140x70	PL90414070B	226 €
160x70	PL90416070B	248 €
170x70	PL90417070B	263 €
180x70	PL90418070B	273 €
80x80	PL9048080B	159 €
90x80	PL9049080B	164 €
100x80	PL90410080B	174 €
110x80	PL90411080B	186 €
120x80	PL90412080B	193 €
130x80	PL90413080B	206 €
140x80	PL90414080B	231 €
150x80	PL90415080B	259 €
160x80	PL90416080B	280 €
170x80	PL90417080B	282 €
180x80	PL90418080B	299 €
190x80	PL90419080B	303 €
90x90	PL9049090B	179 €
100x90	PL90410090B	192 €
120x90	PL90412090B	210 €
140x90	PL90414090B	246 €
160x90	PL90416090B	289 €
180x90	PL90418090B	329 €
140x100	PL904140100B	319 €
160x100	PL904160100B	361 €
180x100	PL904180100B	396 €



Accesorios / Accessories / Accessoires



Desagüe Ø90 h74 mm
Waste Ø90 h74 mm
Bonde Ø90 h74 mm

ACC655

33 €



Desagüe vertical Ø90 h100 mm
Vertical waste Ø90 h100 mm
Bonde verticale Ø90 h100 mm

ACC656

38 €



Desagüe extraplano Ø90 h53 mm
Superslim waste Ø90 h53 mm
Bonde superslim Ø90 h53 mm

ACC657

39 €

No admite corte

It can not be cut

Ne peut pas être coupé

Logic marco

sanylite slate



Antideslizante Clase III
Anti-slip Class III
Antidérapant Class III



Incluye rejilla inox
Stainless steel grate included
Comprend grille en acier inoxydable





sanylite

Logic marco 140x90

Logic marco





Logic marco

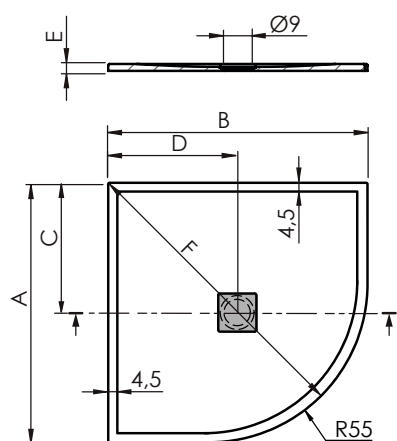

dim.cm	A	B	C	D	E	F
80x80	80	80	45	45	4,5	92,7
90x90	90	90	45	45	4,5	104,3

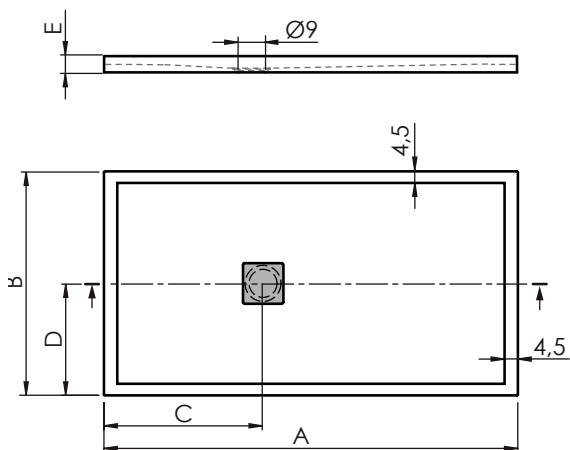

dim.cm	A	B	C	D	E
90x70	90	70	40	35	4,5
100x70	100	70	40	35	4,5
120x70	120	70	45	35	4,5
140x70	140	70	50	35	4,5
160x70	160	70	52	35	4,5
170x70	170	70	52	35	4,5
180x70	180	70	52	35	4,5
80x80	80	80	40	40	4,5
90x80	90	80	40	40	4,5
100x80	100	80	40	40	4,5
110x80	110	80	45	40	4,5
120x80	120	80	45	40	4,5
130x80	130	80	50	40	4,5
140x80	140	80	50	40	4,5
150x80	150	80	52	40	4,5
160x80	160	80	52	40	4,5
170x80	170	80	52	40	4,5
180x80	180	80	52	40	4,5
190x80	190	80	52	40	4,5
90x90	90	90	40	45	4,5
100x90	100	90	40	45	4,5
120x90	120	90	45	45	4,5
140x90	140	90	50	45	4,5
160x90	160	90	52	45	4,5
180x90	180	90	52	45	4,5
140x100	140	100	52	50	4,5
160x100	160	100	52	50	4,5
180x100	180	100	52	50	4,5

Plato de ducha / Shower tray / Receveur de douche



r= 55cm

80x80	PL9098080SB	191 €
90x90	PL9099090SB	207 €
90x70	PL9099070B	185 €
100x70	PL90910070B	190 €
120x70	PL90912070B	207 €
140x70	PL90914070B	243 €
160x70	PL90916070B	294 €
170x70	PL90917070B	323 €
180x70	PL90918070B	334 €
80x80	PL9098080B	191 €
90x80	PL9099080B	195 €
100x80	PL90910080B	205 €
110x80	PL90911080B	219 €
120x80	PL90912080B	229 €
130x80	PL90913080B	244 €
140x80	PL90914080B	263 €
150x80	PL90915080B	306 €
160x80	PL90916080B	331 €
170x80	PL90917080B	340 €
180x80	PL90918080B	355 €
190x80	PL90919080B	360 €
90x90	PL9099090B	207 €
100x90	PL90910090B	227 €
120x90	PL90912090B	249 €
140x90	PL90914090B	292 €
160x90	PL90916090B	342 €
180x90	PL90918090B	391 €
140x100	PL909140100B	376 €
160x100	PL909160100B	427 €
180x100	PL909180100B	468 €



Accesorios / Accessories / Accessoires



Desagüe Ø90 h74 mm
Waste Ø90 h74 mm
Bonde Ø90 h74 mm

ACC655

33 €



Desagüe vertical Ø90 h100 mm
Vertical waste Ø90 h100 mm
Bonde verticale Ø90 h100 mm

ACC656

38 €



Desagüe extraplano Ø90 h53 mm
Superslim waste Ø90 h53 mm
Bonde superslim Ø90 h53 mm

ACC657

39 €

No admete corte.

It can not be cut.

Ne supporte pas la coupe.

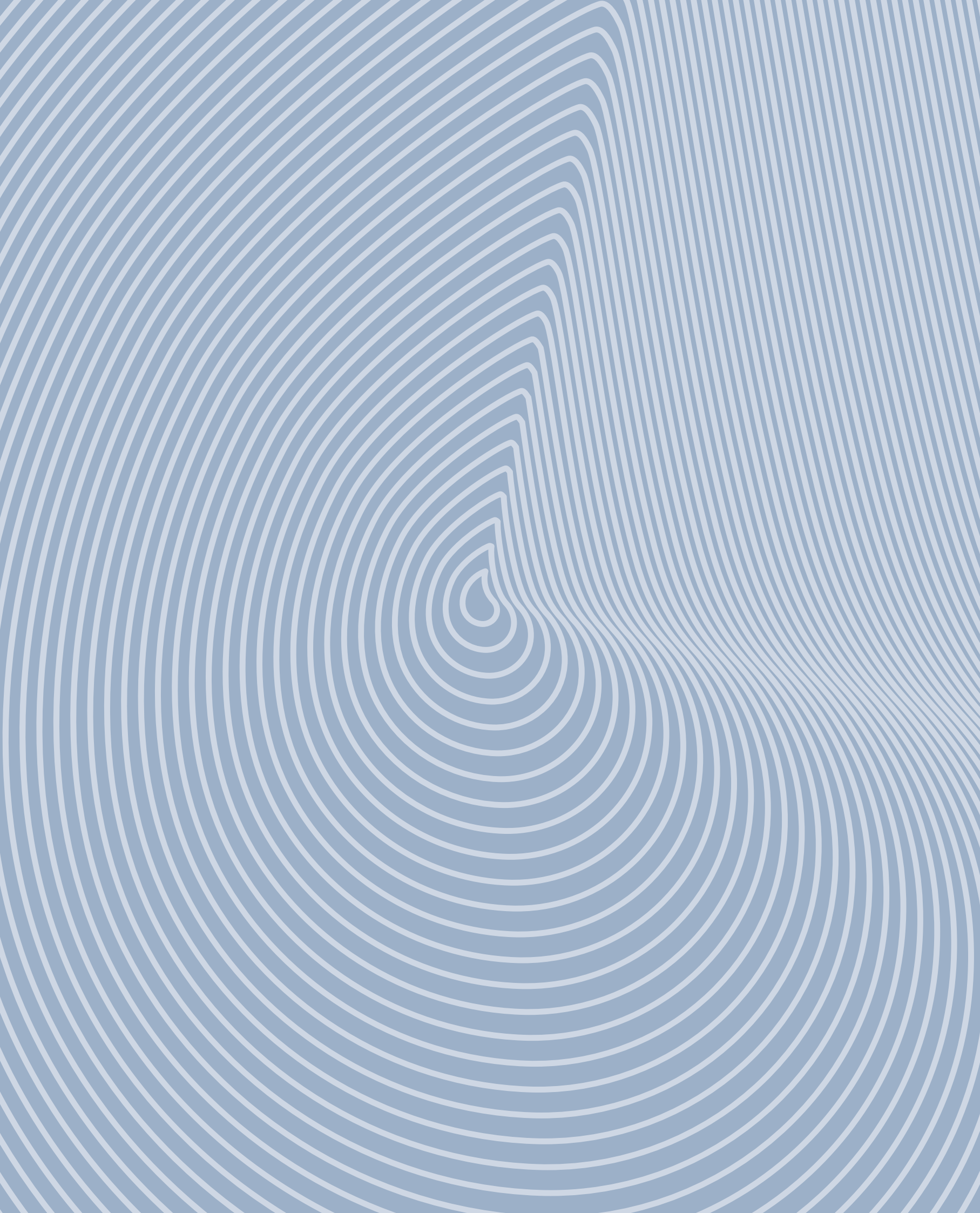



Displays

Expositores

Presentoirs

Platos

Shower trays
Receveurs



Caja de muestras colores platos Sanydur Sanylite
Sample box Sanydur Sanylite shower tray colours
Boîte d'échantillons de couleurs Sanydur Sanylite
de receveurs de douche

EXPLTCOL

*



Logic



Logic con marco



New York

Expositor plato de ducha sanylite
sanylite shower trays display
Presentoir receveurs sanylite

EXPMUNY

*

* Consulte condiciones con nuestro departamento comercial.

* See conditions with our sales department.

* Consultez les conditions avec notre département commercial.



Bandeja expositora platos con trasera
 Shower trays display with back
 Bande d'exposant receveurs avec logo

EXPPLTRAY

*

* No incluye muestras, se complementa con la caja de muestras de colores EXPLTCOL.

* No samples included, complemented by the EXPLTCOL colour sample box.

* Aucun échantillon inclus, complété par la boîte d'échantillons de couleurs EXPLTCOL.



Strato



Clever

Expositor plato de ducha sanydur / sanitaryacrylic
 sanydur / sanitaryacrylic shower trays display
 Presentoir receveur sanydur / sanitaryacrylic

EXPSGRSTR

*

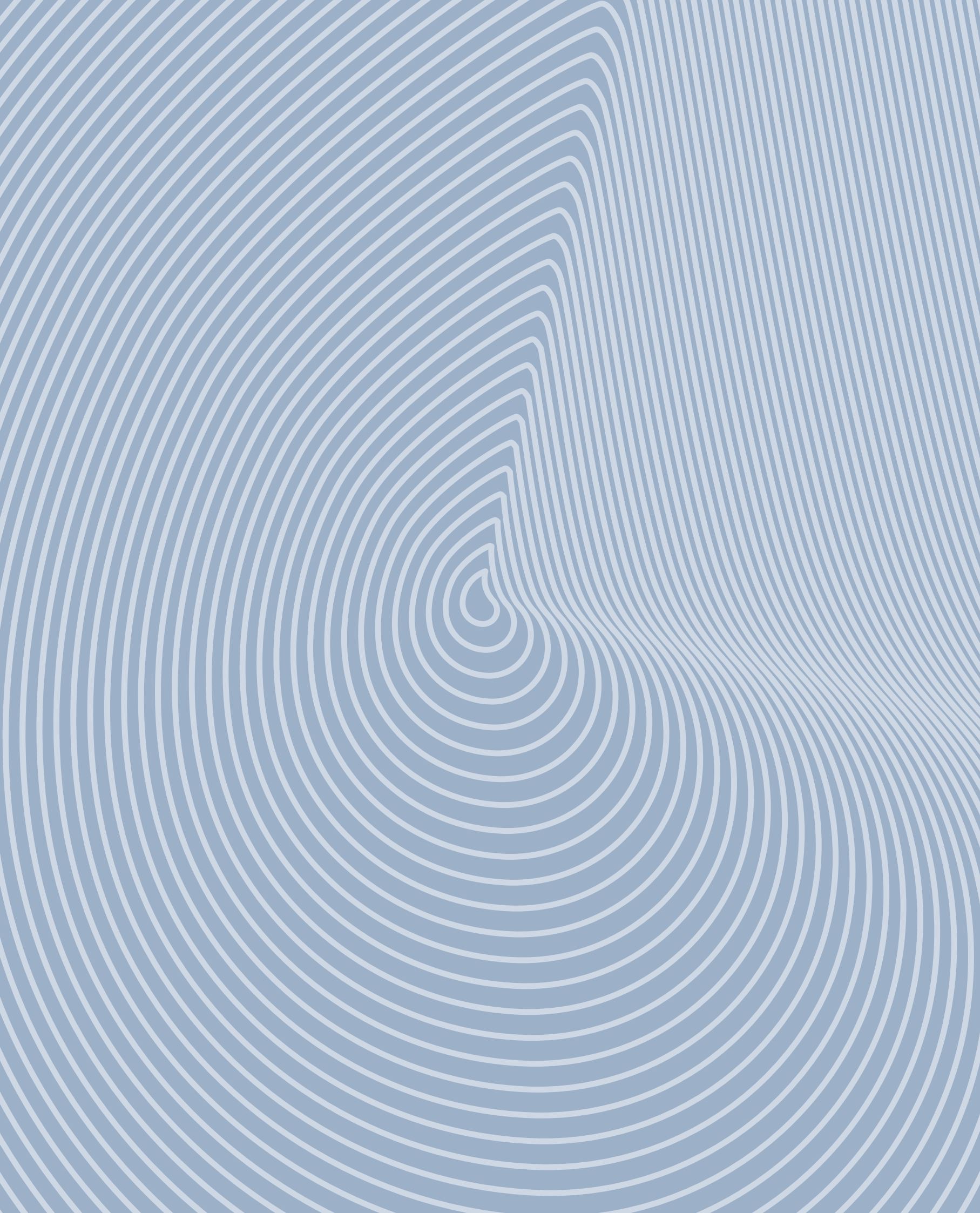

Materials

Al final, toda la calidad es percibida a través del material...

In the end, quality is perceived through the material...

A la fin, toute la qualité est perçue à travers de la matière...

sanysize

Nuestros conceptos

Sanysize abarca cualquier fabricación con formato a medida. Los productos con sanysize establecen un rango de medida cm a cm permitiendo el ajuste o la fabricación del producto dentro de ese rango.

Our concepts

Sanysize covers any manufacturing with custom format. The products with sanysize establish a range of measurement cm to cm allowing the adjustment or manufacture of the product within that range.

Nos concepts

Sanysize couvre toute fabrication avec un format personnalisé. Les produits avec sanysize établissent une gamme de mesure cm à cm permettant s'ajuster ou la fabrication du produit dans cette gamme de mesures.

sanycoat

Los recubrimientos **sanycoat** sobre productos **Solid Sanycces®** permiten personalizar el exterior del producto con colores fácilmente combinables entre sí. El recubrimiento es de alta resistencia apto para su uso en baños.

Sanycoat coatings on **Solid Sanycces®** products allow to personalize the exterior of the product with colors easily combinable with each other. The coating is of high resistance suitable for use in bathrooms.

Les revêtements **sanycoat** sur les produits **Solid Sanycces®** permettent de personnaliser l'extérieur du produit avec des couleurs facilement combinables. Le revêtement est de haute résistance adapté pour une utilisation dans les salles de bains

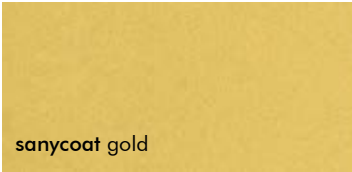

sanycoat gold

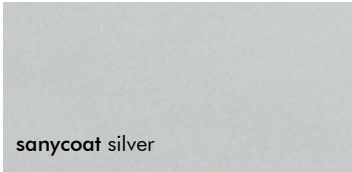

sanycoat silver

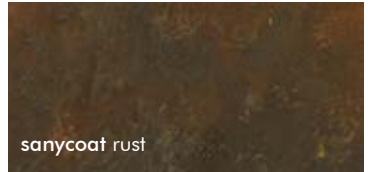

sanycoat rust

Los colores de las fotografías no son vinculantes, para una mejor identificación del color, consultar carta RAL o NCS.

The colors of the photographs are not binding, for a better identification of the color, consult RAL or NCS card.

Les couleurs des photos peuvent être légèrement différentes. Pour une meilleure identification de la couleur, consultez les nuanciers RAL o NCS.

customral customncs

Los productos con **customral** y **customncs** ofrecen la posibilidad de fabricarse con los colores de dichas cartas, convirtiéndose en grandes aliados para arquitectos, interioristas y decoradores.

Customral and **customncs** products offer the possibility of being manufactured with the colors of these letters, becoming great allies for architects, interior designers and decorators.

Les produits **customral** et **customncs** peuvent être fabriqués avec toutes les couleurs de ces nuanciers. Ils se constituent comme de grands alliés des architectes, interioristes, decorateurs

sanygrip

Es nuestro tratamiento antideslizante para platos y bañeras. Consulte sus propiedades en las páginas siguientes.

Is our antislip treatment for shower trays and bathtubs. See its properties in the following pages.

C'est notre traitement antidérapant pour les receveurs et les baignoires. Voir leurs propriétés sur les pages suivantes.

	Nuestros materiales:	Our materials	Nos matériaux:
Solid Sanycces®	Es nuestro material solid surface, consulte sus ventajas, propiedades y métodos de limpieza en las páginas siguientes.	Is our solid surface material, see its advantages, properties and cleaning methods in the following pages.	Notre matériel en solid surface, vérifiez ses avantages, propriétés et méthodes de nettoyage dans les pages suivantes
sanydur gel coat	Es un material compuesto por un núcleo de cargas minerales y resina y una superficie de gel coat sanitario. Consulte sus ventajas y métodos de limpieza en las páginas siguientes.	Is a material composed of a core of mineral fillers with resin and a surface of sanitary gel coat. See its advantages, properties and cleaning methods in the following pages.	Matériel composé d'un noyau de charges minérales et de résine et d'une surface de gel coat sanitaire. Voir ses avantages et méthodes de nettoyage dans les pages suivantes.
sanylite gel coat	Es una evolución del sanydur pues presenta una superficie de gel coat sanitario idéntica a éste, pero su núcleo está fabricado de GRP, con lo que el ahorro en peso es significativo. Consulte sus ventajas y métodos de limpieza en las páginas siguientes.	Is an evolution of sanydur because it has a surface of sanitary gel coat identical to this one, but its core is made of GRP, with which the saving of weight is significant. See its advantages, properties and cleaning methods in the following pages.	C'est une évolution de sanydur car elle présente une surface de gel coat identique à celle-ci, mais son noyau est en GRP, par lequel le poids est moindre. Voir ses avantages et méthodes de nettoyage dans les pages suivantes.
sanitaryacrylic	La lámina acrílica sanitaria con que se producen algunos modelos de bañeras y de platos de ducha. Consulte sus ventajas en las páginas siguientes.	The sanitary acrylic sheet with which some bathtubs and shower tray models are produced. See its advantages in the following pages.	La feuille d'acrylique sanitaire avec laquelle sont fabriqués certains modèles de baignoires et de receveurs de douche. Voir ses avantages dans les pages suivantes.

solid[®]

sanycces

A la vanguardia de los materiales compuestos, **Solid Sanycces[®]** es nuestro material solid surface. Esta familia de materiales ofrece al diseño un abanico ilimitado de posibilidades técnicas y estéticas. Su tacto sedoso y cálido junto con su apariencia mineral y su índice de reflexión de la luz lo convierten en un material capaz de transformar cualquier pieza en la protagonista del baño.

At the forefront of composite materials, **Solid Sanycces[®]** is our solid surface material. This family of materials offers to design an unlimited range of technical and aesthetic possibilities. Its silky and warm touch with its stone-like appearance and reflectivity of light make it a material capable of transforming any bathroom piece in protagonist.

A la pointe des matériaux composés, **Solid Sanycces[®]** est notre matière Solid Surface. Cette famille offre un éventail illimité de possibilités de conceptions techniques et esthétiques. Tant son apparence minérale comme son toucher soyeux et chaud et son indice de réflexion de la lumière le convertisse en un matériel capable de transformer n'importe quelle pièce en protagoniste de la salle de bain.



Desarrollado y producido completamente por y para Sanycces. La fórmula del **Solid Sanycces®**, fruto de una profunda investigación en materiales composites Solid Surface, es única.

Developed and produced entirely by and for Sanycces. The formula of **Solid Sanycces®** results of thorough research into Solid Surface composite materials, it is unique.

Développée et produite dans son intégralité par et pour Sanycces, la formule du **Solid Sanycces®**, résultat d'une intense recherche dans les matériaux composite Solid Surface, est unique.

Propiedades:

Properties:

Propriétés:

Fácil limpieza



Su superficie no porosa facilita la limpieza.

Easy cleaning

Its non-porous surface makes cleaning easy.

Nettoyage facile

Sa surface non poreuse facilite son nettoyage.

Agradable al tacto



Su superficie es suave y cálida.

Pleasant to the touch

Its surface is smooth and warm.

Agréable au toucher

Sa surface est douce et chaude.

Homogéneo



Material compacto y uniforme en todo su espesor.

Homogeneous

Compact and uniform material throughout its thickness.

Homogène

Matériel compacte et uniforme dans toute son épaisseur.

Color



Su color es estable.

Color

Its color is stable.

Couleur

Sa couleur est stable.

Resistente a químicos.



Su exclusiva formulación lo hace resistente a productos de limpieza de uso habitual en el baño.

Chemical Resistant

Its unique formulation makes it resistant to cleaning agents commonly used in the bathroom.

Résistant aux produits chimiques.

Sa formule exclusive lui permet de résister aux produits de nettoyage habituels de salle de bain.

Higiénico



Su composición y no porosidad resulta en un material altamente higiénico.

Hygienic

Its composition without porosity turns in a highly hygienic material.

Hygénique

Sa composition et sa surface non poreuse en fait de lui un matériel hautement hygiénique.

Sanysize



Permite el corte a medida y configuraciones especiales.

Sanysize

It allows cutting to size and Special configurations.

Sanysize

Il permet la découpe sur mesure et les configurations spéciales.

Sanycoat



Permite tratamientos cromáticos y texturizados.

Sanycoat

Allows chromatic treatments and textured.

Sanycoat

Il permet les traitements chromatiques et de texture.

Recuperable



Su superficie permite recuperar el aspecto del primer día con el uso de esponjas abrasivas suaves.

Renewable

Its surface allows recovering the appearance of the first day with the use of soft-abrasive sponges.

Récupérable

Sa surface permet de récupérer l'aspect du premier jour grâce à l'utilisation d'éponges abrasives douces.

Reparable



Pequeños accidentes en la superficie pueden restaurarse.

Reparable

Scratches or small accidents on the surface can be restored.

Réparable

Les petits incidents en surface peuvent se récupérer.

Alta dureza



Las cargas minerales aportan una elevada dureza y resistencia al desgaste haciendo la superficie duradera.

High hardness

Mineral fillers provide high hardness and wear resistance making a long-lasting surface.

Haute solidité

Les charges minérales apportent un indice élevé de solidité et résistance à l'usure créant une surface longévive.

Technical characteristics

Las características mecánicas y físicas de Solid Sanycces® así como su idoneidad para la fabricación de equipamiento para el baño han sido testeadas bajo los más rigurosos estándares europeos e internacionales.

The mechanical and physical Solid Sanycces® features, as well as its suitability for the manufacture of bathroom equipment have been tested under the most stringent European and International standards.

Les caractéristiques mécaniques et physiques de Solid Sanycces® ainsi que son adéquation à la fabrication d'équipements pour la salle de bain ont été testées suivant les standards européens et internationaux les plus rigoureux.

Property	Standard	Test Method	Result	Units	Requirement
Densidad Density Densité	DIN ISO 1183-1	Inmersión Immersion Immersion	1,927	g/cm3	-
Resistencia al impacto Impact resistance Résistance aux chocs	ISO 19712	Bola (324g 0,61m) Large ball (324g 0,61m) Grosse boule (324g 0,61m)		-	Sin roturas ni desconches No breaks or chips Aucune fissure ou écaillage
Dureza superficial Hardness Dureté	UNE 53270	Bárcol	65	Escala bárcol Barcol scale échelle Barcol	-
Resistencia a la abrasión Abrasion resistance Résistance à l'abrasion	ISO 5470-1	-	166	mg/100 cycles	-
Resistencia al choque térmico (65-10°C) Thermal shock resistance (65-10°C) Résistance aux chocs thermiques (65-10°C)	ISO 19712-3	B (500 cycles)		-	Sin roturas ni desconches No breaks or chips Aucune fissure ou écaillage
Resistencia al calor húmedo Resistance to wet heat Résistance à la chaleur humide	ISO 19712-3	A	5 (sin cambios visibles) 5 (no visible changes) 5 (aucun changement visible)	Escala cualitativa (1-5) Qualitative scale (1-5) échelle qualitative (1-5)	>3 (ligeros cambios en brillo y/o color) >3 (Slight changes in brightness and / or color) >3 (De légères variations de luminosité et / ou couleur)
Resistencia a químicos y manchas Resistance to chemicals and stains Résistance chimique et aux taches	ISO 19712-3	A	5 (sin cambios visibles) 5 (no visible changes) 5 (aucun changement visible)	Escala cualitativa (1-5) Qualitative scale (1-5) échelle qualitative (1-5)	>3 (ligeros cambios en brillo y/o color) >3 (Slight changes in brightness and / or color) >3 (De légères variations de luminosité et / ou couleur)
Resistencia a la quemadura del cigarrillo Cigarette burn resistance Résistance à la brûlure de cigarette	ISO 19712-3	A	5 (sin cambios visibles) 5 (no visible changes) 5 (aucun changement visible)	Escala cualitativa (1-5) Qualitative scale (1-5) échelle qualitative (1-5)	>3 (ligeros cambios en brillo y/o color) >3 (Slight changes in brightness and / or color) >3 (De légères variations de luminosité et / ou couleur)
Solidez del color a la luz Lightfastness Solide couleur à la lumière	ISO 19712-3	A	4,5-5 (muy buena) 4,5-5 (very good) 4,5-5 (très bonne)	Escala de grises (1-5) Grey scale (1-5) Niveaux de gris (1-5)	4-5 (de buena a excelente) 4-5 (From good to excellent) 4-5 (Bon à excellent)
Test superficial Surface test Test de surface	ISO 19712-3		0,7	mm2	Superficie afectada max 1 mm2/m2 Affected area Max 1 mm2 / m2 Zone touchée max 1 mm2 / m2
Conformidad marcado CE CE marking conformity Conformité marquage CE	EN 14527 EN 14688 EN 14516			-	

Chemical resistance and cleaning

Nuestra preocupación por el comportamiento del material va más allá de los requisitos normativos basados en tests estandarizados. Conocemos lo que ocurre en condiciones de uso y mantenimiento habituales y definimos los siguientes protocolos de limpieza para que su producto en Solid Sanycces® luzca como el primer día.

Our concern for the material behaviour goes beyond bathroom regulatory requirements based on standardized tests. We know what happens in the Terms of regular use and maintenance, and define the following cleaning protocols so that your product in Solid Sanycces® looks like the first day.

Notre constante préoccupation pour le comportement du matériel va au-delà des normes requises basées sur des tests standardisés. Connaisseurs de son devenir suivant des conditions d'utilisation et de maintenance habituelles, nous définissons les protocoles suivants de nettoyage afin que votre produit en Solid Sanycces® reste comme au premier jour.

Agents	Cleaning method
Aguarrás Turpentine White spirit	1
Acetona Acetone Acétone	3
Disolvente universal Universal solvent Dissolvant universel	1
Alcohol metílico Methylated Spirits Alcool méthylique	1
Lejía Bleach Eau de javel	4
Amoniaco Ammonia Ammoniac	2
Ácido clorhídrico Hydrochloric acid acide chlorhydrique	3
Desatacadór doméstico Domestic Toilet plunger Déboucheur domestique	4
Cillit BANG	2
Vinagre Vinegar Vinaigre	2
Limpiador de WC WC cleaner Liquide nettoyant de WC	2
Quitamanchas Stain remover Antitâches	1

Agents	Cleaning method
Limpiador multiusos Multipurpose cleaner Gel nettoyant multi tâches	2
Betadine Betadine (Type mercure au chrome)	4
Peróxido de hidrógeno Hydrogen peroxide Eau oxygénée	1
Alcohol Etilico 96° Ethyl alcohol 96° Alcool éthylique 96°	1
Tinte para cabello Hair colour Coloration capillaire	5
Esmalte de uñas Nail Polish Vernis à ongles	6
Maquillaje Make up Maquillage	4
Betún calzado Shoe Polish Cirage à chaussures	4
Rotulador permanente Permanent marker Marqueur permanent	7
Limón Lemon Citron	2
Café Coffee Café	5
Vino tinto Red wine Vin rouge	5

1. Retirar con un trapo seco.
2. Aclarar con agua.
3. Esponja de fibra blanca.
4. Esponja de fibra blanca + limpiador en crema abrasivo.
5. Esponja de fibra verde + limpiador en crema abrasivo.
6. Eliminar con quitaesmalte de uñas.
7. Eliminar con alcohol.

1. Remove with dry cloth.
2. Rinse with water.
3. White fiber scrubber.
4. White fiber scrubber + abrasive creamy cleaner.
5. Green fiber scrubber + abrasive creamy cleaner.
6. Remove with nail polish remover.
7. Remove with alcohol.

1. Enlever à l'aide d'un linge sec.
2. Rincer à l'eau.
3. Éponge à récurer de fibres blanches
4. Éponge à récurer de fibres blanches + gel nettoyant en crème avec agent abrasif.
5. Éponge à récurer de fibres vertes + gel nettoyant en crème avec agent abrasif.
6. Enlever à l'aide de dissolvant.
7. Enlever avec alcool méthylique.

sanydur gel coat

Sanydur gel coat es un material compuesto por un núcleo de cargas minerales y resina y una superficie de gel coat que le concede propiedades sanitarias a los productos fabricados con este material.

Sanydur gel coat is a material composed of a core of mineral fillers and resin and a gel coat surface that brings sanitary properties to the products made with this material.

Sanydur gel coat est un matériau composé d'un noyau de charges minérales et de résine et d'une surface de revêtement de gel qui confère des propriétés sanitaires aux produits fabriqués avec ce matériau.



sanydur Clever colors

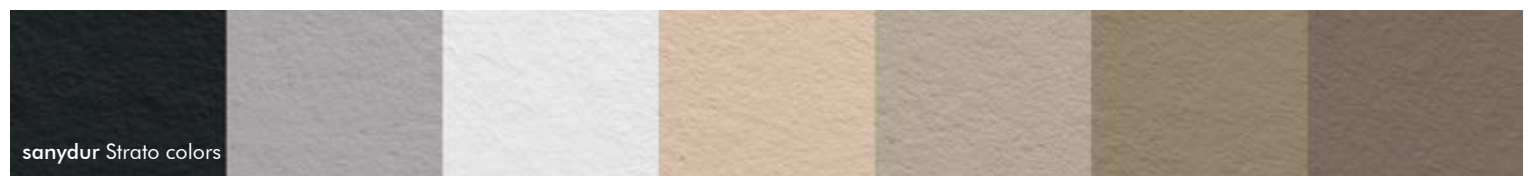

sanydur Strato colors

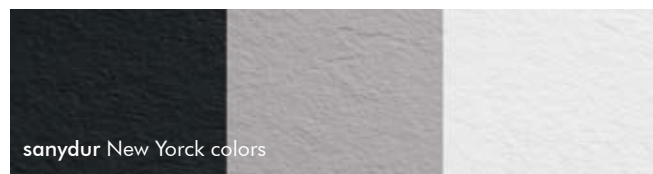

sanydur New Yorck colors

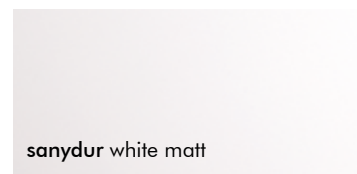

sanydur white matt

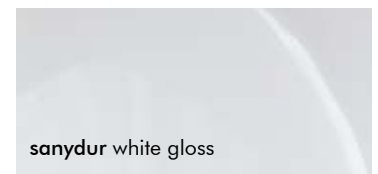

sanydur white gloss

Los colores de las fotografías no son vinculantes, para una mejor identificación del color, consultar carta RAL o NCS.

The colors of the photographs are not binding, for a better identification of the color, consult RAL or NCS card.

Les couleurs des photos peuvent être légèrement différentes. Pour une meilleure identification de la couleur, consultez les nuanciers RAL ou NCS.



Sanysize

Permite el corte a medida y configuraciones especiales.

Sanysize

It allows cutting to size and Special configurations.

Sanysize

Il permet la découpe sur mesure et les configurations spéciales.

sanylite gel coat

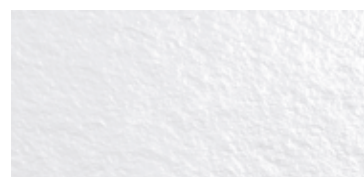

Sanylite gel coat es un material compuesto por un núcleo de GRP y una superficie de gel coat. Los productos fabricados con **sanylite gel coat** tienen un peso cuatro veces menor que el de productos equivalentes en **sanydur gel coat** u otros composites.

Ligero

Su bajo peso optimiza el transporte y facilita la instalación.

Sanylite gel coat is a GRP and gel coat composed material. Products made with **sanylite gel coat** have a weight four times less than equivalent products in **sanydur gel coat** or other composites.

Lightweight

Its low weight optimizes the transport and facilitates the installation.

Sanylite gel coat est un matériau composé d'un noyau de GRP et d'une surface de couche de gel. Les produits fabriqués avec **sanylite gel coat** ont un poids quatre fois moins que des produits équivalents à **sanydur gel coat** ou à d'autres composites.

Légère

Su bajo peso optimise le transport et facilite l'installation.



Sanydur gel coat y sanylite gel coat comparten propiedades y prestaciones.

Propiedades:

Fácil limpieza

Su superficie no porosa facilita la limpieza.



Agradable al tacto

Su superficie es suave y cálida.



Color

Su color es estable.



Resistente a químicos

Su exclusiva formulación lo hace resistente a productos de limpieza de uso habitual en el baño.



Higiénico

Su composición y no porosidad resulta en un material altamente higiénico.



Reparable

Pequeños accidentes en la superficie pueden restaurarse.



Alta dureza

Las cargas minerales aportan una elevada dureza y resistencia al desgaste haciendo la superficie duradera.



Antideslizante

La textura pizarra está clasificada como clase 3 conforme al CTE (código técnico de la edificación y ensayo ENV12633).



Garantía

Los platos de ducha fabricados con **sanydur gel coat** y **sanylite gel coat** tienen una garantía de 5 años.



Sanydur gel coat and sanylite gel coat share properties and benefits.

Properties:

Easy cleaning

Its non-porous surface makes cleaning easy.

Pleasant to the touch

Its surface is smooth and warm.

Color

Its color is stable.

Chemical resistant

Its unique formulation makes it resistant to cleaning agents commonly used in the bathroom.

Hygienic

Its composition without porosity turns in a highly hygienic material.

Reparable

Scratches or small accidents on the surface can be restored.

High hardness

Mineral fillers provide high hardness and wear resistance making a long-lasting surface.

Antislip

Slate texture is classified as class 3 according to the CTE (spanish technical code for building and test ENV12633).

Warranty

Shower trays made with **sanydur gel coat** and **sanylite gel coat** have a 5 year warranty.

Sanydur gel coat et sanylite gel coat partagent des propriétés et des avantages.

Propriétés:

Nettoyage facile

Sa surface non poreuse facilite son nettoyage.

Agréable au toucher

Sa surface est douce et chaude.

Couleur

Sa couleur est stable.

Résistant aux produits chimiques

Sa formule exclusive lui permet de résister aux produits de nettoyage habituels de salle de bain.

Hygénique

Sa composition et sa surface non poreuse en fait de lui un matériel hautement hygiénique.

Réparable

Les petits incidents en surface peuvent se récupérer.

Haute solidité

Les charges minérales apportent un indice élevé de solidité et résistance à l'usure créant une surface longévive.

Antidérapant

La texture de l'ardoise est classée en classe 3 selon le CTE (code technique du bâtiment espagnol et test ENV12633).

Garantie

Les plateaux de douche fabriqués avec **sanydur gel coat** et **sanylite gel coat** bénéficient d'une garantie de 5 ans.

sanydur gel coat

sanylite gel coat

Definimos los siguientes protocolos de limpieza para que su producto en **sanydur gel coat** y **sanylite gel coat** luzcan como el primer día.

We define the following cleaning protocols so that your product in **sanydur gel coat** and **sanylite gel coat** look like the first day.

nous définissons les protocoles suivants de nettoyage afin que votre produit en **sanydur gel coat** et **sanylite gel coat** reste comme au premier jour.

Agents	Cleaning method
Aguarrás Turpentine White spirit	1
Acetona Acetone Acétone	2
Disolvente universal Universal solvent Dissolvant universel	1
Alcohol metílico Methylated Spirits Alcool méthylique	1
Lejía Bleach Eau de javel	2
Amoniaco Ammonia Ammoniac	2
Ácido clorhídrico Hydrochloric acid acide chlorhydrique	2
Desatacadador doméstico Domestic Toilet plunger Déboucheur domestique	2
Cillit BANG	2
Vinagre Vinegar Vinaigre	2
Limpiador de WC WC cleaner Liquide nettoyant de WC	2
Quitamanchas Stain remover Anti-tâches	1

- 1.Retirar con un trapo seco.
- 2.Aclarar con agua.
- 3.Aclarar con lejía en gel.
- 4.Esponja de fibra blanca + lejía.
- 5.Esponja de fibra verde + limpiador en crema abrasivo.
- 6.Eliminar con quitaesmalte de uñas.
- 7.Eliminar con alcohol.

Agents	Cleaning method
Limpiador multiusos Multipurpose cleaner Gel nettoyant multi tâches	2
Betadine Betadine (Type mercure au chrome)	3
Peróxido de hidrógeno Hydrogen peroxide Eau oxygénée	2
Alcohol Etílico 96º Ethyl alcohol 96º Alcool éthylique 96º	2
Tinte para cabello Hair colour Coloration capillaire	4
Esmalte de uñas Nail Polish Vernis à ongles	6
Maquillaje Make up Maquillage	4
Betún calzado Shoe Polish Cirage à chaussures	4
Rotulador permanente Permanent marker Marqueur permanent	7
Limón Lemon Citron	2
Café Coffee Café	5
Vino tinto Red wine Vin rouge	4

- 1.Remove with dry cloth.
- 2.Rinse with water.
- 3.Rinse with bleach in gel.
- 4.White fiber scrubber + bleach.
- 5.Green fiber scrubber + abrasive creamy cleaner.
- 6.Remove with nail polish remover.
- 7.Remove with alcohol.

- 1.Enlever à l'aide d'un linge sec.
- 2.Rincer à l'eau.
- 3.Rincer avec de l'eau de javel en gel.
- 4.Éponge à récurer de fibres blanches + eau de Javel.
- 5.Éponge à récurer de fibres vertes + gel nettoyant en crème avec agent abrasif.
- 6.Enlever à l'aide de dissolvant.
7. Enlever avec alcool méthylique.

sanitaryacrylic

En Sanycces empezamos nuestro proyecto en 1993 con bañeras fabricadas con lámina acrílica sanitaria reforzada con resina y fibra de vidrio. Durante toda nuestra trayectoria el acrílico ha demostrado ser un material robusto y atemporal.

- Fácil limpieza.
- Uso sanitario.
- Color estable.
- Estable con la temperatura.
- Resistencia a químicos.

In Sanycces we started our project in 1993 with bathtubs made of sanitary acrylic sheet reinforced with resin and fiberglass. Throughout our history the acrylic has proven to be a robust and timeless material.

- Easy cleaning.
- Health use.
- Stable color.
- Stable with temperature.
- Resistance to chemicals.

Chez Sanycces, notre projet a commencé en 1993 par la fabrication de baignoires en feuille d'acrylique sanitaire renforcée avec de la résine et de la fibre de verre. Pendant toute notre trajectoire, l'acrylique a démontré être un matériel robuste et intemporel.

- Nettoyage facile.
- Utilisation sanitaire.
- Couleur stable.
- Constant avec la température.
- Résistance aux éléments chimiques.



sanygrip

Sanygrip es un tratamiento antideslizante e incoloro para platos de ducha y bañeras, que le permite un mejor agarre en superficies lisas y evita resbalones en materiales como el **Solid Sanycces®** o el acrílico. Con **sanygrip** las superficies adquieren un nivel antideslizante Clase III o Clase C internacional.

- Fácil limpieza.
- Antideslizante.
- Garantizado 3 años.
- Certificado por el ITC.

Sanygrip is a colorless and antislip treatment for shower trays and bath tubs, which allows a better grip on smooth surfaces and avoid slipping on materials such as **Solid Sanycces®** or acrylic. With **sanygrip** surfaces acquire antislip level Class III or International Class C.

- Easy cleaning.
- Anti-slip.
- Guaranteed 3 years.
- Certified by ITC.

Sanygrip est un revêtement antidérapant et incolore pour receveurs de douche et baignoires qui permet une meilleure grippe sur les surfaces lisses et évite de possibles glissades sur les matériaux comme le **Solid Sanycces®** ou l'acrylique. Avec **sanygrip** les surfaces obtiennent un niveau antidérapant de Classe III ou Classe C Internationale.

- Nettoyage facile.
- Antidérapant.
- Garantie 3 ans.
- Certifié par ITC.



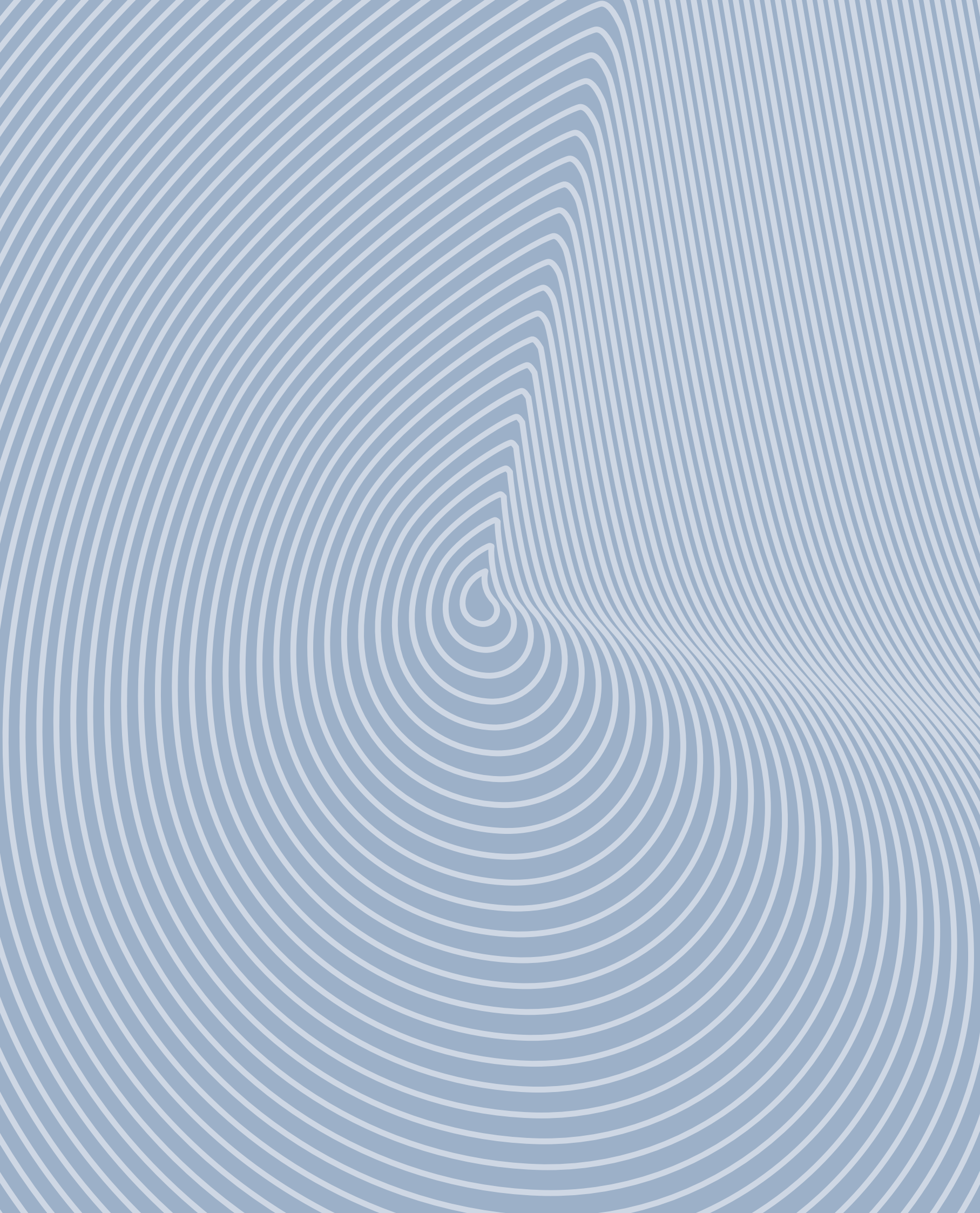

General info

Información general

Informations générales

GARANTÍA

Los productos Sanycces® están garantizados según la normativa europea vigente. Dicha garantía comprende los tres años siguientes a partir de la fecha de factura del producto emitida por Sanycces. Se considerarán válidas aquellas reclamaciones que sean realizadas por escrito. La garantía cubre los defectos de fabricación. La garantía no cubre deterioros no imputables al producto, materiales consumibles que pierden su efectividad con el uso, defectos derivados de negligencia en su manipulación, defectos derivados de la presión del agua excesiva en la red, al igual que los cuerpos extraños en el agua.

Sanycces asume la garantía de sus productos, quedando entendido y expresamente convenido que dicha garantía se limitará a la sustitución de los productos que resultasen defectuosos por fabricación, con exclusión de cualquier otra compensación, daños o interés.

MATERIAL EXPOSICIÓN

Todo el material con destino a la exposición y precios especiales, tiene que mantenerse en exposición mínimo 12 meses, de no ser así, se procedería a emitir una nueva factura por el diferencial entre el descuento habitual del cliente y el que se le haya concedido por descuento especial para exposición.

CONDICIONES GENERALES

Los embalajes están incluidos en los precios, excepto en la compra de la bañera acrílicas por unidad sin hidromasaje.

En exportación, si su pedido no llega al valor mínimo pactado en sus condiciones de trabajo. Se le facturarán los portes indicados en las mismas.

COBERTURA DE RIESGO

Serán aceptados sólo aquellos pedidos que queden cubiertos por la compañía de riesgo con la que estamos operando. Para los pedidos, que no amparados por la compañía de aseguradora, deberán ofrecerse otras medidas de pago garantizado.

PEDIDOS

Todos los pedidos deberán cursarse siempre por escrito, bien por fax o correo electrónico y en caso de cursarse por teléfono, deberán confirmarse por cualquiera de los medios citados. Los pedidos se considerarán en firme desde el primer momento de su recepción, no admitiéndose posibles cambios, modificaciones posteriores ni anulaciones. Los descuentos que

deban aplicarse a las ventas de nuestros productos se efectuarán según las condiciones pactadas con el cliente.

DEVOLUCIONES

Transcurridas 24 horas desde que el pedido se recibió en Sanycces, no se admitirán anulaciones. Una vez suministrado el pedido, no se admitirán devoluciones. En el caso de que se aceptara alguna devolución, se aplicaría una quita del 15 % sobre el valor de la mercancía. Rogamos revisen el material a su entrega. No se admitirán devoluciones sobre el material que haya sido instalado. Por roturas. La mercancía que se envía por transporte ordinario viaja asegurada, por lo que en caso de reclamación por roturas esta deberá hacerse antes de las 24 horas siguientes a la recepción de la misma. En caso de que no puede revisar la mercancía en el momento de la entrega realizada por el transportista se deberá hacer constar en el albarán de entrega del transporte pendiente de revisión. En caso de que el cliente verifique la rotura fuera de plazo, deberá ponerse en contacto con su representante al objeto de subsanar la incidencia producida. De todas formas insistimos en hacer hincapié de que revise todo el material a la recepción del mismo.

PREINSTALACIÓN ELÉCTRICA

Requisitos Indispensables:

La responsabilidad sobre la contratación de suministro eléctrico es exclusiva del propietario de la vivienda. Dicha Instalación eléctrica, tiene que ser llevada a cabo por un técnico electricista cualificado y teniendo en cuenta las normativas vigentes de cada país. Puede que haya ciertas restricciones y/o requisitos que sean específicos de su localidad. Si tiene dudas, compruébelo en su Ayuntamiento. Habrá de obtenerse un certificado del electricista que verifique que se ha testado todo el circuito eléctrico que afecte o pueda afectar al funcionamiento de la cabina, bañera, Spa o sauna.

El suministro eléctrico para una bañera o Spa debe ser realizado por una línea exclusiva que no deberá compartirse con otros elementos. Dicho suministro eléctrico será de 230 V y deberá llegar al emplazamiento de instalación de la bañera, Spa .

AVISO: En caso de no suministrar la potencia recomendada, quedará sin vigencia la garantía del fabricante. Los equipos de instalación solamente

podrían realizar la conexión en aquella red eléctrica que haya sido instalada de manera profesional y debidamente comprobada. Es obligatoria la conexión a un interruptor magneto térmico adecuado al consumo del equipo y a un diferencial magneto térmico de máximo 30mA. Las secciones de los conductores deben tener en cuenta no sólo la absorción de la instalación, sino también el recorrido de los cables y sus distancias. Los sistemas de protección elegidos y las normas correspondientes a las instalaciones eléctricas estables vigentes en el país donde se va a instalar la bañera o Spa. El electricista tendrá que cumplir dichas disposiciones. También tendrá que utilizar empalmes estancos en los puntos de unión. Así como garantizar que se ha cumplido con las normas correspondientes a instalaciones vigentes del país de emplazamiento y verificar con un certificado, que el circuito se ha testado convenientemente.

ASISTENCIA TÉCNICA Y POSTVENTA

Una red de asistencia técnica distribuida por todo el territorio nacional y portugués les garantiza la tranquilidad de tener siempre cerca un profesional de Sanycces.

Nuestro estricto control de calidad hace que confiemos en lo que ofrecemos. Aún así y completando nuestra garantía, ponemos a su disposición nuestro propio servicio de asistencia postventa donde encontrará un gran equipo de profesionales dispuesto a ayudarle, informarle y solucionar cualquier incidencia que tenga.

La estratégica situación de nuestras bases de asistencia postventa nos permite una ágil y rápida respuesta coordinada desde nuestras oficinas centrales. Disponemos de todos los medios necesarios para hacerle llegar nuestros productos en las mejores condiciones. Con el fin de facilitarles la atención a sus consultas y necesidades con la mayor agilidad posible, hemos incluido en nuestro servicio postventa una dirección de correo electrónico y un número exclusivo:

postventa@sanycces.es

Tel. (+34) 964 51 82 02

NOTA: Sanycces, S.L. se reserva el derecho de cambiar alterar o retirar cualquier producto o componentes del mismo sin previo aviso. Estar en posesión de nuestro Catálogo o Tarifa no otorga el derecho a compra de ninguno de nuestros productos.

NOTA: El fabricante recuerda la obligatoriedad de colocar paneles o

registros para poder acceder a los dispositivos del interior de la bañera. En el material acrílico las medidas son aproximadas y pueden variar en base a una tolerancia de ± 5 mm.

NOTA: Los colores de las fotografías no son vinculantes, para una mejor identificación del color, consultar carta RAL o NCS.

NORMAS

Y CERTIFICACIONES

- Bañeras:
UNE-EN 14516

- Bañeras con hidromasaje y spas:
UNE-EN 12764

- Platos de ducha
UNE-EN 14527

WARRANTY

Sanycces® products are guaranteed under existing European legislation. This guarantee covers the following three years from the Sanycces invoice date of the product. Will be considered valid those claims that are made in writing. The guarantee covers manufacturing defects. The warranty does not cover damage not attributable to the product. consumible parts, products which cease to function through use, damage attributable to negligence handling, damage attributable to excessive water pressure in the water network as well as foreign bodies in the water.

Sanycces assumes the warranty of its products, being expressly understood and agreed that such warranty is limited to replacement of the products that were defective in manufacture, and no other compensation, damages or interest.

SHOWROOM PRODUCTS

All material destined for the showroom with special prices, has to be kept minimum 12 months in the showroom, otherwise, would proceed to issue a new invoice for the difference between the regular customer discount and the discount which has been granted by special discount for showroom.

GENERAL CONDITIONS

The packages are included in the prices, except for the purchase of the unit acrylic bath, without whirlpool.

For export, if your order does not reach the minimum value agreed in your conditions of work. You will be invoiced for the shipping costs indicated in the terms and conditions.

RISK COVERAGE COMPANY

Will only be accepted those which are covered by the risk coverage company with which we operate. Orders not underwritten by the insurance company must offer other guaranteed means of payment.

ORDERS

All orders should be made whenever writing or by fax or e-mail, and if filled by telephone, must be confirmed by any of the means listed. Orders are considered firm at the outset of their receipt, not admitting possible changes, posterior modifications or cancellations. The discounts to be applied to sales of our products are made in accordance with the set conditions agreed with the customer.

RETURNS

No devolution will be accepted after 24 hours since the material was received by the customer. In the case in which a devolution was accepted, a 15% on the value of the material would be paid by the customer. Please, we beg you revise the material the day you receive it. No devolutions will be accepted on the already installed material.

For breakage. The merchandise that travels by regular transportation is insured, so if there is a claim for breakage must be made within 24 hours after receipt thereof. If you can not inspect the goods at the time of delivery by the carrier must be recorded in the transport delivery order pending review. If the client verifies the breaking out of time, should contact their representative in order to overcome the impact produced. However we insist that all the material to check the receipt.

ELECTRIC PREINSTALLATION

Essential requirements:

The responsibility for the hiring of electricity supply is for the sole owner of the house. The electrical installation has to be conducted by a qualified electrician, and taking into account the regulations of each country. There may be certain restrictions and/or requirements that are specific to their location. When in doubt, check in his City Hall. It should obtain a certificate from the electrician that verifies that has been tested throughout the electrical circuit which affect or may affect the operation of the bathtub or Spa.

The power supply for this cabin, tub or spa will be performed by a dedicated line that must not be shared with other elements. That electricity supply will be 230 V and must arrive at the site of installation of the cabine, bathtub, spa or sauna.

NOTE: In case of not being supplied by the recommended power supply, the manufacturer's warranty will remain invalid. Installation teams could only make the connection on that electrical grid that has been installed in a professional manner and rightly tested. Is mandatory the connection to a switch magnet adequate to the heat consumption of equipment and a thermal magnet differential of maximum 30mA. Sections of the conductors must take into account not only the absorption of the facility, but also the route of the cables and their distances. The elected protection systems and standards for electrical installations stable force in the country where

the project is to install the cabine, bathtub, spa or sauna. The electrician will have to comply with those provisions. You will also need to use watertight joints at the points of unity. Just as guarantee that the installation has been complied with the standards for the existing facilities of the country of deployment and with a certificate verifying that the circuit has been tested adequately.

TECHNICAL ASSISTANCE AND POST SALE

A network of technical assistance distributed throughout the country and Portugal guarantees you the safety of always having near a professional of Sanycces. Our strict quality control means that we trust what we offer. Even so, and completing our guarantee, we offer our own after-sales service for assistance to find a great team of professionals willing to help, inform and solve any incidence you may have.

The strategic position of our after-sales assistance bases, enables us to a fast and coordinated response from our headquarters. We have all the necessary means to convey to you our products in the best possible conditions.

In order to provide care to their queries and needs with the greatest flexibility the possible, we have included in our after-sales service an e-mail address and an exclusive telephone number:

postventa@sanycces.es

Int. (+34) 964 51 82 02

NOTE: Sanycces, S.L. The manufacturer reserves the right to change, alter or withdraw any products or components thereof without previous notice. Possessing our catalog or price list does not give the right to purchase any of our products.

NOTE: The manufacturer recalls the obligation to put panels or registers to access to the devices inside the bathtub. In Acrylic materials measures are approximate and may vary. Dimensional tolerances ± 5 mm. Measures for the placement of the faucets are indicative.

NOTE: The colors of the photographs are not binding, for a better identification of the color, consult RAL or NCS card.

STANDARDS AND CERTIFICATIONS:

- Bathtubs:
UNE-EN 14516
- Whirlpool bathtubs and spas:
UNE-EN 12764
- Shower enclosures:
UNE-EN 14428
- Shower trays:
UNE-EN 14527

GARANTIES

Les produits Sanycces® sont garantis selon la législation européenne en vigueur. La garantie débute à la date de facture du produit émise par Sanycces, commandé et la période de validité est 3 ans. Seules les réclamations écrites seront prises en compte. Les garanties couvrent les défauts de fabrication. La garantie ne couvre pas les dommages non attribuables au produit, le renouvellement des produits qui perdent leurs fonctionnalités avec l'usage, sont les appelés consommables, les défauts consécutifs à une utilisation anormale du produit, les défauts consécutifs à une pression d'eau excessive du réseau ou à la présence de corps étrangers dans l'eau.

Sanycces garantit ses produits, étant sous entendu et expressément convenu que cette garantie couvre uniquement le remplacement des produits qui présentent des défauts de fabrication, et exclut toute autre indemnisation, dommages et intérêts.

PRODUITS POUR EXPOSITIONS

Tout le matériel qui sera destiné pour expositions et prix spéciaux, doit rester en exposition durant au moins 12 mois, dans le cas contraire, on devra refacturer entre la remise habituelle du client et la remise spéciale faite pour l'exposition.

CONDITIONS GÉNÉRALES DE VENTE

Les frais d'emballages sont inclus, à exception de l'emballage des baignoires acryliques sans hydromassage.

Pour l'exportation, si votre commande n'atteint pas la valeur minimale convenue dans vos conditions de travail. Les frais d'expédition indiqués dans les conditions générales vous seront facturés.

RECOUVREMENT

Seules les commandes couvertes par notre société de recouvrement seront acceptées. Pour les commandes non couvertes par notre société de recouvrement, une garantie alternative de paiement devra être donnée.

COMMANDES

Les commandes doivent nous être adressées soit par fax ou par e-mail. Si la commande a été effectuée par téléphone, elle devra obligatoirement faire l'objet d'une confirmation écrite par fax ou

e-mail afin d'éviter tout problème d'interprétation de quantités, références et prix. Les commandes sont considérées comme fermes et définitives dès réception, et aucune modification, total ou partielle, ou annulation ne sera acceptée. Toute remise applicable sur le montant de nos produits sera établie selon les accords pactés au préalable avec le client.

RETOURS

Passé un délai de 24 heures après réception de la commande chez Sanycces, aucune annulation ne sera acceptée. Aucun retour de marchandise ne sera accepté une fois la commande livrée. En cas d'acceptation de retour d'une marchandise, le matériel retourné sera crédité sur la base de 85% du prix initial.

Important: Merci de bien vouloir vérifier le produit acheté à sa réception. Aucun retour ne sera admis sur un produit installé. Casse. La marchandise fait l'objet d'un envoi sécurisé par transport ordinaire. Tout problème de casse devra être signalé dans les 24 heures après réception. Dans le cas où il ne vous serait pas possible de vérifier la marchandise au moment de la livraison réalisée par le transporteur, il vous faudra mentionner "Sous réserve de contrôle de l'état du contenu" sur le bordereau de réception. Passé le délai de 24 heures, le client devra contacter son représentant afin de résoudre l'incidence. Il est très important de vérifier la marchandise lors de sa réception.

INSTALLATION ÉLECTRIQUE

Conditions fondamentales: Le propriétaire est responsable de vérifier la puissance électrique disponible. L'installation électrique doit être réalisée par un électricien agréé et ceci suivant les normes en vigueur. En cas de doute, contacter votre mairie pour déterminer toute restriction locale. L'électricien qualifié devra émettre un certificat attestant avoir contrôlé tout le circuit électrique affectant ou pouvant affecter le fonctionnement de la baignoire ou spa. L'alimentation électrique pour cette cabine, balnéo ou Spa doit être réalisée par un câblage exclusif qui ne devra pas être partagé avec d'autres éléments. L'alimentation sera de 230 V et devra rejoindre l'emplacement de la baignoire ou spa.

ATTENTION: Le non respect de la puissance électrique à fournir indiquée entraînera l'annulation de la garantie. Les équipes d'installation réaliseront uniquement la connexion à un réseau électrique ayant été installée de manière professionnelle et ayant été correctement contrôlée. La connexion à un interrupteur magnéto-thermique conforme pour la consommation de l'équipement et à un disjoncteur magnéto-thermique de 30mA maximum est obligatoire. Les sections des conducteurs doivent tenir compte de l'absorption de l'installation ainsi que du parcours des câbles et les distances. Les systèmes de protection choisis doivent être conformes aux normes en vigueur du pays où sera installé la cabine, balnéo, spa ou sauna. L'électricien devra suivre les indications et les normes en vigueur. Il devra aussi utiliser des joints étanches dans les points de jonction. L'électricien qualifié devra garantir que toutes les normes et législation en vigueur soient respectées et devra émettre un certificat confirmant que le circuit a été vérifié correctement.

ASSISTANCE TECHNIQUE ET SERVICE APRÈS-VENTE

Un réseau d'assistance technique distribué sur tout le territoire national et portugais vous proportionne la tranquillité d'avoir toujours près de vous un professionnel de Sanycces. L'excellente qualité de nos produits est assurée par une gestion très stricte de notre service qualité. Cependant et en accord avec notre garantie, nous avons un service après-vente à votre disposition composé par une grande équipe de professionnels prêts à vous aider, à vous informer et à résoudre toute incidence. La situation stratégique de nos centres d'assistance après-vente nous permet une réponse agile et rapide, coordonnée par nos bureaux centraux. Nous disposons des moyens nécessaires pour vous faire parvenir nos produits dans les meilleures conditions. Notre Service après-vente met à votre disposition une adresse email et un numéro de téléphone exclusif pour répondre à vos attentes:

postventa@sanycces.es
Int. (+34) 964 51 82 02

NOTICE: Sanycces, S.L., le fabricant, se réserve le droit, à tout moment, de modifier ou de supprimer tout produit, équipement ou composant présent dans ce catalogue et ce, sans préavis. Être en possession de notre Catalogue ou Tarif ne constitue en aucun cas un droit d'achat sur nos produits. **NOTICE:** Le fabricant vous rappelle l'obligation de poser des panneaux ou des boîtiers pour faciliter l'accès aux dispositifs en cas d'intervention. Dans le matériel acrylique, les dimensions sont approximatives et peuvent varier. Tolérance ± 5 mm. Les dimensions pour la pose de la robinetterie sont orientatives.

NOTICE: Les couleurs des photographies ne sont pas contractuelles, pour une meilleure identification de la couleur, consultez la carte RAL ou NCS.

NORMES ET CERTIFICATIONS

- Baignoires:
UNE-EN 14516

- Balneo et spas:
UNE-EN 12764

- Paroi de douche:
UNE-EN 14428

- Receveur:
UNE-EN 14527

Art direction and graphic design

Sanycces design team

Photography

Vicent Clausell (Clausell studio)
Ángel Segura foto

Print

Imedisa

Special thanks to

Nadis Design

Naturtex

Cerámica a mano alzada

Orac Decor



Pol. Ind. Carabona
C/ Coure P-11 Apdo. 158
12530 Burriana (Castellón) SPAIN
Tel. +34 964 518 202
info@sanycces.es
www.sanycces.es

Sanycces se reserva el derecho a anular o modificar los productos o cualquiera de sus atributos que aparecen en este catálogo. La reproducción de los colores es aproximada.

Sanycces reserves the right to cancel or modify the products or any of their attributes appearing in this catalogue. Colour reproduction is approximate.

Sanycces se réserve le droit d'annuler ou de modifier les produits ou l'un de leurs attributs figurant dans ce catalogue. La reproduction des couleurs est approximative.