



Sobime
ABRIL 2022

RACORES DE LATÓN
RACCORDS EN LAITON
BRASS FITTINGS
ЛАТУННЫХ ФИТИНГОВ И АКЦЕССУАРОВ
KSZTAŁTKI MOSIĘŻNE I AKCESORIA



SOB-RAC 22-04-1





MATERIALES UTILIZADOS

Fabricación por estampación en caliente con latón según norma UNE-EN-12165 CW617N Cumple con los requisitos de composición química especificados por el Enfoque Común 4MS, 5ª Revisión de fecha 7 de marzo de 2016 (enfoque para materiales metálicos en contacto con agua potable) Fabricación por fundición con latón según norma EN-1982 CB753S

MATERIAUX UTILISÉS

Fabrication pour étampage en chaud avec laiton selon norme UNE-EN-12165 CW617N Conforme aux exigences des compositions chimiques visées par l' « Approche Commune 4MS », 5ème Révision du 7 Mars 2016 (approche des matériaux métalliques en contact avec l'eau potable) Fabrication pour fonte avec laiton selon norme EN-1982 CB753S

MATERIALS USED

Manufacture by hot stamping with brass according to regulation UNE-EN-12165 CW617N Complies with the requirements of chemical composition specified by the 4MS Common Approach, 5th Revision dated 07th March 2016: (approach for metallic materials in contact with drinking water) Manufacture by with brass according to regulation EN-1982 CB753S

ИСПОЛЬЗУЕМЫЕ МАТЕРИАЛЫ

Метод производства - горячая штамповка Высококачественная латунь, согласно норме UNE-EN-12165 CW617N Химический состав соответствует требованиям указанных 4МС, 5 пересмотров 7марта 2016 года (фокусировка для металлических материалов в контакте с питьевой водой) Метод производства - литье Высококачественная латунь, согласно норме EN-1982 CB753S

UŻYTE MATERIAŁY

Produkowane w procesie odkuwania na gorąco z mosiądzu zgodnie z normami UNE-EN-12165 CW617N Zgodność z wymogami dot. składu chemicznego określonego przez zrzeczenie 4 państw członkowskich, 5-ta poprawka z dnia 7 marca 2016 (dopuszczenie materiałów metalowych do kontaktu z wodą pitną). Produkowane w procesie odlewania z mosiądzu zgodnie z normami EN-1982 CB753S

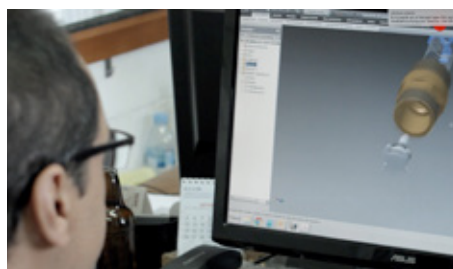
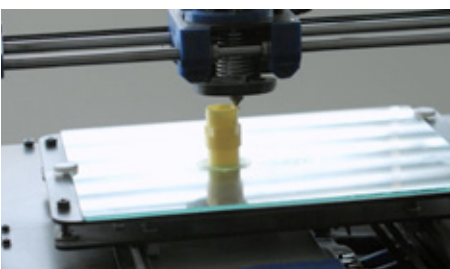



Sobime

Todas las empresas del grupo SOBIME, que incluyen refinera y estampación en caliente, trabajamos para que nuestros clientes tengan a su alcance una gama de productos con un alto nivel de calidad.

Los productos SOBIME son reconocidos por su excelencia, conseguida gracias al esfuerzo y la autoexigencia de todo nuestro personal en cada uno de los niveles de producción y comercialización.

En SOBIME hemos apostado por la tecnología más avanzada puesta al servicio de nuestros clientes para hacer frente a un mercado cada vez más exigente.

La intensa labor de nuestro equipo de I+D consigue que los productos de SOBIME estén en primera línea del mercado por su gran resistencia y durabilidad.

La obtención de la certificación ISO 9001 en Diseño, Fabricación y Comercialización de Racorería de Latón y Grifería Sanitaria, es un

reconocimiento a la madurez y eficacia de nuestro Sistema de Gestión de la Calidad.

En SOBIME S.A. ejercemos un control absoluto sobre todos los procesos de fabricación de nuestros productos, desde la elaboración de la materia prima hasta la distribución del artículo final.

Nuestras existencias de racores y grifería nos permiten responder a cualquier pedido con total rapidez y con la garantía de SOBIME S.A.



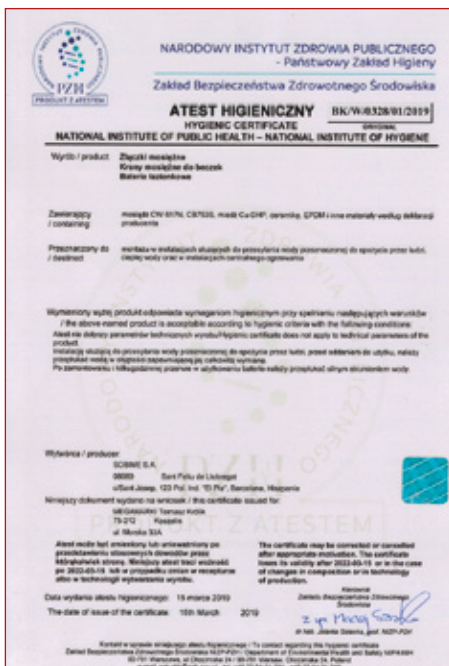



- 8 Índice de imágenes - index d'images - table of pictures
Индекс изображений - Zestawienie rysunków
- 15 Racores de latón para roscar
Raccords en laiton pour fileter · Threaded brass fittings
Латунные фитинги · Gwintowane kształtki mosiężne
- 41 Accesorios de latón para riego
Accessoires pour arrosage · Irrigation connectors
Соединители шлангов для полива · Łączniki irygacyjne
- 46 Colectores
Collecteurs · Manifolds
Коллекторы · Rozdzielacze
- 48 Válvulas y accesorios
Clapets et accessoires · Valves and accessoires
Вентили и аксессуары · Zawory i akcesoria
- 52 Bebederos cerdos
Robinet abreuvoir pour porcs · Drinking spouts for pigs
Поилки для поросят · Poidelko dla świń
- 53 Grifos varios
Robinetterie variée · Various taps
Специальные краны · Krany różne
- 59 Accesorios varios
Complements divers · Assorted accessories
Аксессуары разные · Akcesoria różne
- 70 Accesorios para tubería de cobre
Raccords en laiton pour tube de cuivre
End feed fittings for copper tube
Фитинги для медных труб
Złączki do rur miedzianych
- 78 Racores de compresión para tubo de cobre
Raccords à compression pour tube de cuivre
Compression fittings for copper tube
Компрессионные фиттинги для медной трубы
Złączki skręcane do rur miedzianych
- 85 Racores para tubo pex y multicapa
Raccords pour tube pex et multicouche
Fittings for pex and multilayer tube
Фитинги для металлопластиковых труб
Złączki do rur pex oraz rur wielowarstwowych
- 89 Racores de latón para tubo de polietileno
Raccords laiton pour tube polyéthylène · Brass fittings for polyethylene pipes
Латунные фитинги для полиэтиленовых труб
Złączki mosiężne do rur z polietylenu
- 90 Índice por código
Index de codes · Code index
индекс Код · Kod Głównaa
- 92 Condiciones de venta
Conditions de vente · Terms of sale
Условия продажи · Zasady sprzedaży

· Racores de latón para roscar · Raccords en laiton pour fileter · Threaded brass fittings
 · Латунные фитинги · Gwintowane kształtki mosiężne

							
pag: 15			pag: 16				
							
pag: 17							
							
pag: 18			pag: 19		pag: 20		
							
pag: 21			pag: 22		pag: 23		
							
pag: 24			pag: 25			pag: 26	
							
pag: 27				pag: 28			
							
pag: 29							

· Racores de latón para roscar · Raccords en laiton pour fileter · Threaded brass fittings
 · Латунные фитинги · Gwintowane kształtki mosiężne

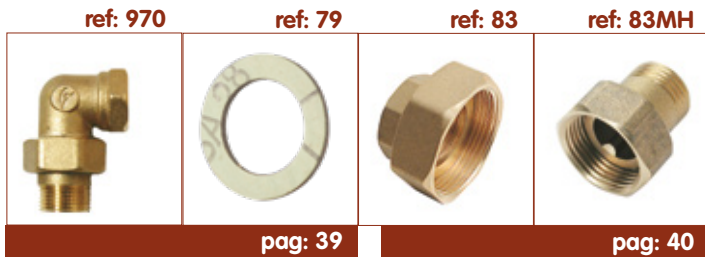

· Accesorios de latón para riego · Accessoires pour arrosage · Irrigation connectors
· Соединители шлангов для полива · łączniki irygacyjne

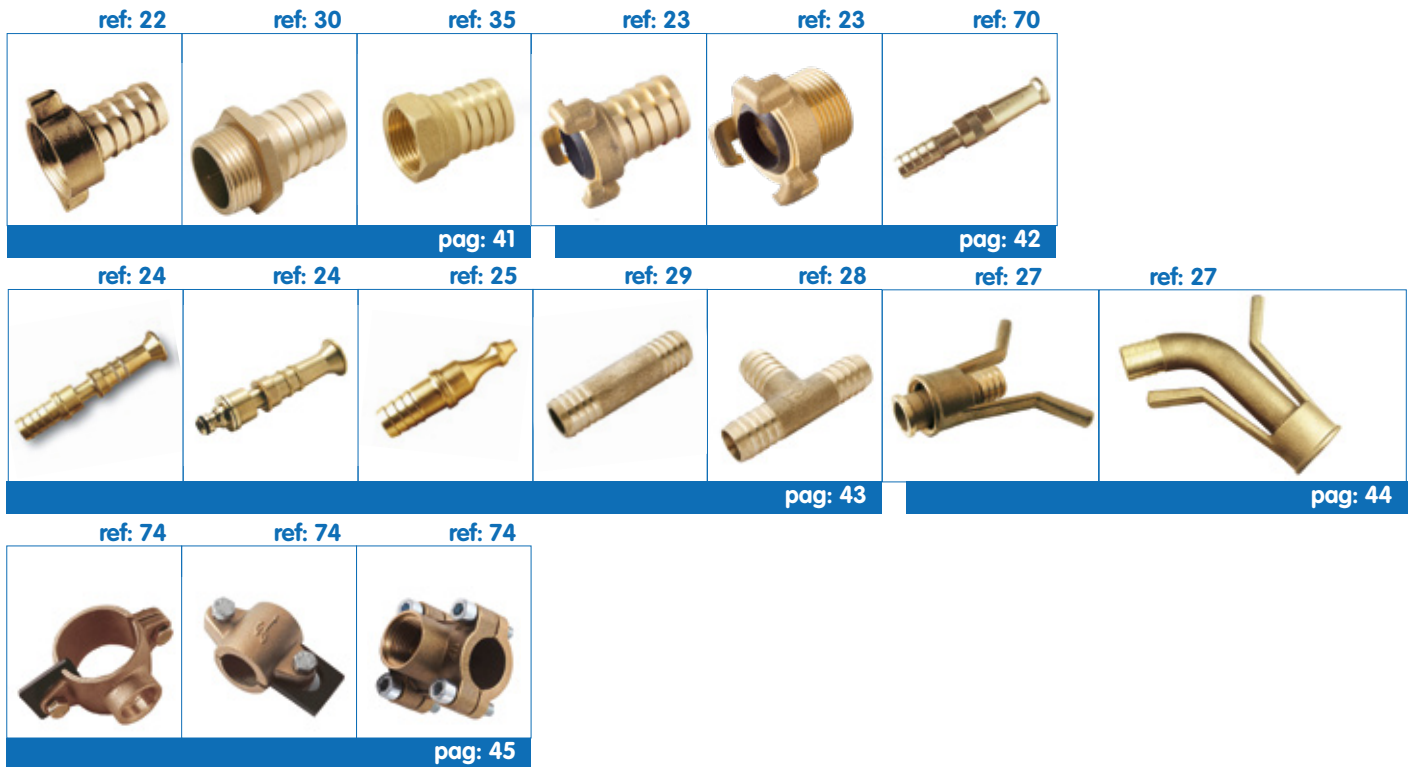

· Colectores · Collecteurs · Manifolds
· Коллекторы · Rozdzielacze



· Válvulas y accesorios · Clapets et accessoires · Valves and accessories
· Вентили и аксессуары · Zawory i akcesoria



· Bebederos cerdos · Robinet abreuvoir pour porcs · Drinking spouts for pigs
 · Поилки для поросят · Poidełko dla świń



· Grifos varios · Robinetterie variée · Various taps
 · Специальные краны · Krany różne



· Accesorios varios · Complements divers · Assorted accessories
 · Аксессуары разные · Akcesoria różne

















· Accesorios varios · Complements divers · Assorted accessories
 · Аксессуары разные · Akcesoria różne



· Accesorios para tubería de cobre · Raccords en laiton pour tube de cuivre · End feed fittings for copper tube
 · Фитинги для медных труб · Złączki do rur miedzianych

ref: 90GCu	ref: 90GCu	ref: 90GCu	ref: 92GCu	ref: 98GCu	ref: 130GCu	ref: 180Cu
						
pag: 70				pag: 71		
ref: 243 GCu	ref: 270GCu	ref: 301Cu	ref: 340Cu	ref: 340GCu	ref: 341GCu	ref: 472GCu
						
pag: 72	pag: 73			pag: 74		
ref: 471GCu	ref: 2AGCu	ref: 359GLCu	ref:1003(85Cu)			
						
pag: 75		pag: 76	pag: 77			

· Racores de compresión para tubo de cobre
 · Raccords à compression pour tube de cuivre · Compression fittings for copper tube
 · Компрессионные фитинги для медной трубы · Złączki skręcane do rur miedzianych

ref: 350	ref: 350R	ref: 352	ref: 354	ref: 356	ref: 356R
					
pag: 78			pag: 79		
ref: 358	ref: 360	ref: 362			
					
pag: 80					
ref: 364	ref: 368	ref: 369	ref: 345	ref: 346	
					
pag: 81			pag: 82		

- Racores para tubo PEX y multicapa
- Raccords pour tube PEX et multicouche · Fittings for PEX and multilayer tube
- Фитинги для металлопластиковых труб · Złączki do rur PEX oraz rur wielowarstwowych

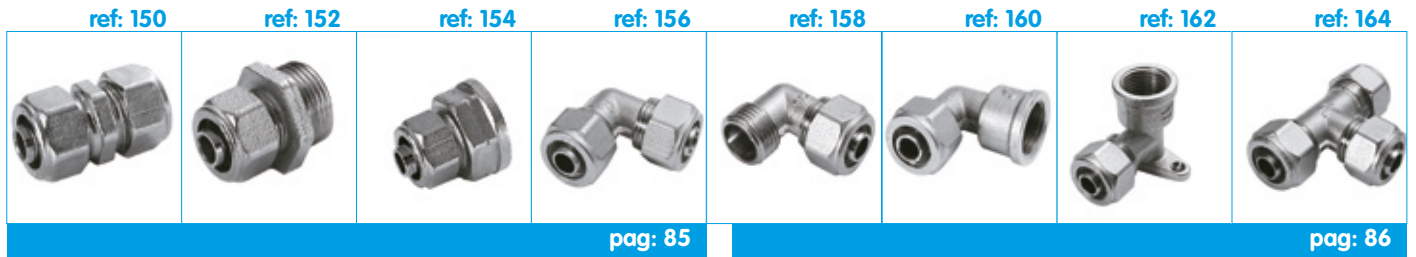

- Racores de latón para tubo de polietileno
- Raccords laiton pour tube polyéthylène · Brass fittings for polyethylene pipes
- Латунные фитинги для полиэтиленовых труб · Złączki mosiężne do rur z polietylenu



Importante - Important - Important - Важно - Ważne

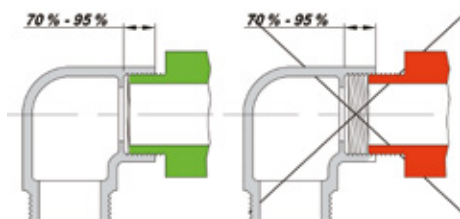

Roscado correcto
 Visage correcte - correct threading
 Правильное соединение - Właściwe nagwintowanie

SIMBOLOGÍA

SYMBOLOLOGIE · SYMBOLOGY
 SYMBOLOGIA · СИМВОЛОГИЯ

CODE	Codigo - Code - Code - Код - Kod
←→	Medida - Measure - Size - Размер - Rozmiar
	EAN13 Bolsa / Caja int. EAN13 Sac / Int. Boîte - EAN13 Bag / Int.Box EAN13 Сумка / Внутр. Коробка EAN13 Opakowanie / Karton wew.
□	Bolsa - Sac - Bag - Пакет - Woreczku
□	Caja int. - Carton int - Внутр. Коробка - Kartonie wewn
□	Caja ext. - Carton ext - Вншн. Коробка - Kartonie zewn



13

- ALARGO CON TUERCA LOCA
- RALLONGE AVEC ÉCROU PRISONNIER · EXTENSION WITH SLIDING NUT
- УДЛИНИТЕЛЬ С ДВИЖНОЙ ГАЙКОЙ · PÓŁSRUBUNEK Z RUCHOMĄ NAKRĘTKĄ



CODE



€

013202	M 1/2" - T.L. 1/2"	8431977214619	10			4,8591
013303	M 3/4" - T.L. 3/4"	8431977214176	10	200		6,5768
013404	M 1" - T.L. 1"			100		9,5189

15

- CONO CONTADOR CON TUERCA LOCA
- CONE COMPTEUR AVEC ÉCROU PRISONNIER · METER CONE WITH SLIDING NUT
- КОНУСНЫЙ ПЕРЕХОДНИК С ГАЙКА ХОДОВОГО ВИНТА
- PÓŁSRUBUNEK DO WODOMIERZA Z RUCHOMĄ NAKRĘTKĄ



CODE



€

015303	M 3/4" - T.L. 3/4"	8431977213704	10	250		7,7482
015404	M 1" - T.L. 1"					10,3115

72

- CODO CON TUERCA LOCA
- COUDE AVEC ECROU PRISONNIER · ELBOW WITH SLIDING NUT
- УГОЛОК С ПЕРЕДВИЖНОЙ ГАЙКОЙ · KOLANO GW/GZ Z RUCHOMĄ NAKRĘTKĄ



CODE



€

072003-HH	T.L. 3/4" - T.L. 3/4"	8431977213698	10	150		9,8372
072004-HH	T.L. 1" - T.L. 1"			100		14,3317



Nuevo · Nouvelle
New · новый · Nowy



72 MH

- CODO MACHO CON TUERCA LOCA
- COUDE MÂLE AVEC ÉCROU PRISONNIER · MALE ELBOW WITH SLIDING NUT
- УГОЛОК С ПЕРЕДВИЖНОЙ ГАЙКОЙ · KOLANO GW/GZ Z RUCHOMĄ NAKRĘTKĄ

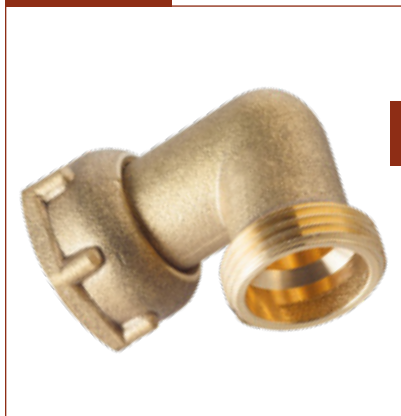

CODE	↔	Barcode	🔗	□	📦	€
072002-MH	M 1/2" - T.L. 1/2"	8431977213674	10		300	3,6860
072003-MH	M 3/4" - T.L. 3/4"	8431977213681	10		150	5,5658
072004-MH	M 1" - T.L. 1"				100	10,2958



CODE	↔	Barcode	🔗	□	📦	€
· NÍQUEL · Niquel · Nickel · Никелированный · Nikiel						
072002-MHN	M 1/2" - T.L. 1/2"	8431977202692	10		300	4,0513
072003-MHN	M 3/4" - T.L. 3/4"	8431977213100	10		150	7,1546



CODE	↔	Barcode	🔗	□	📦	€
· REDUCIDO · Réduit · Reducing · Редукционный · Redukcyjny						
072203-MH	M 1/2" - T.L. 3/4"	8431977214688	10			5,4113



Nuevo · Nouvelle
New · новый · Nowy



98

· TE MACHO CON TUERCA LOCA
· TÉ MÂLE AVEC ECROU PRISONNIER · MALE TEE WITH SLIDING NUT
· ТРОЙНИК С ГАЙКА ХОДОВОГО ВИНТА · TRÓJNIK GW/GZ Z RUCHOMYMI NAKRĘTKAMI



CODE



0980013	M 3/4" - M 3/4" - T.L. 3/4"	8431977213711	5	150	7,4505
0980014	M 1" - M 1" - T.L. 1"			65	12,0732

0980103	M 3/4" - T.L. 3/4" - M 3/4"	8431977213728	5	150	7,4505
0980104	M 1" - T.L. 1" - M 1"			100	12,0732

0980113	M 3/4" - T.L. 3/4" - T.L. 3/4"	8431977213735	5	150	10,9723
0980114	M 1" - T.L. 1" - T.L. 1"			60	16,3122

0981013	T.L. 3/4" - M 3/4" - T.L. 3/4"	8431977213742	5	150	10,9723
0981014	T.L. 1" - M 1" - T.L. 1"			60	16,3122

0981113	T.L. 3/4" - T.L. 3/4" - T.L. 3/4"	8431977213759	5	150	13,5933
0981114	T.L. 1" - T.L. 1" - T.L. 1"			50	19,4621



· COLECTOR MODULAR

· Collecteur modulaire · Modular manifold · Модульный патрубков · Modułowy kolektor

098130203	M3/4"-M1/2" eurocono-T.L.3/4"	8431977214169	5	120	7,8230
098130203-JP	M3/4"-M1/2" j.plana-T.L.3/4"	8431977214152	5	120	7,8230



· JUNTA PLANA · Joint plat · Flat seal · Плоское уплотнение · Uszczelką płaską

099002	T.L. 1/2" (18,5x11x2,5 mm)	8431977215487	100		0,5191
099003	T.L. 3/4" (24x16x3 mm)	8431977215494	100		0,7198



Nuevo · Nouvelle
New · новый · Nowy



33

· ENLACE CONTRA ROSCA MM
· MAMELON DOUBLE ÉGAL MM · HEXAGONAL NIPPLE MM · ПЕРЕХОДНИК Н-Н · NYPEL



CODE	↔	Barcode	Ø	□	田	€
033012	1/8"	8431977200247	25		1000	1,0221
033011	1/4"	8431977200230	25		1000	1,0582
033001	3/8"	8431977200162	25		1000	1,2813
033002	1/2"	8431977200179	25		800	1,3923
033003	3/4"	8431977200209	25		400	2,3612
033004	1"	8431977200216	10		200	4,1195
033005	1.1/4"	8431977200223	10		120	7,0826
033006	1.1/2"	8431977204306	5		80	9,2619
033007	2"				50	14,8575
033008	2.1/2"				30	23,6202
033009	3"				20	34,7757
033040	4"				10	116,4184



· PARA JUNTA PLANA · Pour joint plat · For flat seal
· Для плоского уплотнения · Do uszczelki płaskiej

033003-JPF	3/4"	8431977215371	10		300	2,3508
033004-JPF	1"	8431977215364	10		150	3,7588
033005-JPF	1.1/4"	8431977215401	10		100	6,3094
033006-JPF	1.1/2"	8431977215418	5		75	7,8942
033007-JPF	2"				50	14,4256



· REFORZADO · Renforcé · Heavy duty · Усиленный · Wzmacniany

033022	1/2"	8431977200254	25		500	1,8340
--------	------	---------------	----	--	-----	--------

· REFORZADO PARA JUNTA PLANA · Renforcé pour joint plat · Heavy duty for flat seal
· Усиленный для плоского уплотнения · Wzmacniany do uszczelki płaskiej

033003-JP	3/4" - int.D17	8431977208441	10		300	3,7539
033004-JP	1" - int.D23	8431977213766	10		150	6,0111
033005-JP	1.1/4" - int.D31					10,4369

· CROMO · Chromé · Chrome · Хромированный · Chrom

033011-C	1/4"	8431977210147	25		1000	1,5447
033001-C	3/8"	8431977203293	25		1000	1,7822
033002-C	1/2"	8431977202074	25		800	1,8631
033003-C	3/4"	8431977202456	25		400	3,1035
033004-C	1"	8431977205662	10		200	5,6455
033005-C	1.1/4"	8431977208564	10		120	9,2171
033006-C	1.1/2"				80	11,6113
033007-C	2"				50	18,5689

· ROSCA LARGA · Vis large · Long thread · С удлиненной резьбой · Długi gwint

033002-L	1/2" x 31 mm	8431977200193	25		450	1,8193
033002-L40	1/2" x 40 mm	8431977211328	10		400	2,3272



Nuevo · Nouvelle
New · новый · Nowy



- ENLACE CONTRA ROSCA REDUCIDO MM
· MAMELON DOUBLE RÉDUIT MM · REDUCING HEXAGONAL NIPPLE MM
· ПЕРЕХОДНИК Н-Н РЕДУКЦИОННЫЙ · NYPEL REDUKCYJNY

33R



CODE	←→					€
0331211	1/8" x 1/4"	8431977203316	25		1000	1,0736
033121	1/8" x 3/8"	8431977203415	25		1000	1,3958
033111	1/4" x 3/8"	8431977200278	25		1000	1,2724
033112	1/4" x 1/2"	8431977200285	25		1000	1,5601
033102	3/8" x 1/2"	8431977200261	25		800	1,4010
033203	1/2" x 3/4"	8431977200292	25		500	1,9192
033213	1/2" x 7/8"					3,1425
033204	1/2" x 1"	8431977200308	10		300	3,3826
033205	1/2" x 1.1/4"	8431977200315	10		200	5,7961
033206	1/2" x 1.1/2"	8431977200322	10		150	7,4181
033207	1/2" x 2"	8431977206577	5		80	11,1821
033313	3/4" x 7/8	8431977200360	25		300	3,2580
033304	3/4" x 1"	8431977200339	10		250	3,5070
033305	3/4" x 1.1/4"	8431977200346	10		200	5,2668
033306	3/4" x 1.1/2"	8431977200353	10		150	7,0817
033307	3/4" x 2"	8431977208403	5		80	11,3203
033134	7/8" x 1"	8431977214510	10			4,3149
033405	1" x 1.1/4"	8431977200377	10		180	5,6385
033406	1" x 1.1/2"	8431977200384	10		120	7,1507
033407	1" x 2"	8431977205440	5		80	11,9765
033506	1.1/4" x 1.1/2"	8431977203491	10		100	8,2062
033507	1.1/4" x 2"	8431977206584	5		70	11,8723
033607	1.1/2" x 2"	8431977205945	5		70	12,3851
033609	1.1/2" x 3"					35,5354
033708	2" x 2.1/2"				35	23,9502
033709	2" x 3"				30	37,0289
033809	2.1/2" x 3"				25	36,2298
033840	2.1/2" x 4"				20	120,2403
033940	3" x 4"				15	127,5245

· CROMO · Chromé · Chrome · Хромированный · Chrom

0331211-C	1/8" x 1/4"				1000	1,6183
033121-C	1/8" x 3/8"				1000	1,9183
033111-C	1/4" x 3/8"	8431977210154	25		1000	1,7848
033102-C	3/8" x 1/2"	8431977203200	25		800	1,9404
033203-C	1/2" x 3/4"	8431977204498	25		500	2,5223
033204-C	1/2" x 1"	8431977205686	10		300	4,8224
033206-C	1/2" x 1.1/2"				150	9,3758
033304-C	3/4" x 1"	8431977205709	10		250	5,0056
033305-C	3/4" x 1.1/4"				200	7,0931
033506-C	1.1/4" x 1.1/2"				100	9,6923
033607-C	1.1/2" x 2"				70	14,2989



- REFORZADO PARA JUNTA PLANA
· Renforcé pour joint plat · Heavy duty for flat seal
· Усиленный для плоского уплотнения · Wzmacniany do uszczelki płaskiej

033304-JP	3/4" x 1" - diam. in. 17-23	8431977210796	10		200	4,3736
033305-JP	3/4" x 1.1/4" - diam. in. 17-34	8431977214718	5		100	5,9014
033405-JP	1" x 1.1/4" - diam. in. 23-34				125	6,8802



Nuevo · Nouvelle
New · новый · Nowy



62

- RACOR MARSELLA
- MAMELON ÉGAL MF · HEXAGONAL UNION MF
- ПЕРЕХОДНИК Н-В · PRZEDŁUŻKA SZEŚCIOKĄTNA GZ/GW



CODE	↔					€
062001	3/8"	8431977200599	25		1000	1,1551
062002	1/2"	8431977200605	25		750	1,5236
062003	3/4"	8431977202784	25		400	2,4129
062004	1"	8431977200629	10		200	3,7398
062005	1.1/4"	8431977200636	10		150	6,0393
062006	1.1/2"	8431977204399	5		100	8,6478
062007	2"	8431977208007	5		60	12,6496
062008	2.1/2"				32	25,3348
062222	1/2" x 2 cm	8431977200711	25		500	1,9642
062322	1/2" x 3 cm	8431977200735	25		400	2,4054

- REFORZADO · Renforcé · Heavy duty · Усиленный · Wzmacniany

062022	1/2"	8431977200643	25		500	1,8358
--------	------	---------------	----	--	-----	--------

- CROMO · Chromé · Chrome · Хромированный · Chrom

062001-C	3/8"	8431977204801	25		1000	1,6002
062002-C	1/2"	8431977204610	25		750	2,0287
062003-C	3/4"	8431977207666	25		400	3,0598
062004-C	1"	8431977207741	10		200	5,2131
062005-C	1.1/4"				150	7,9374
062006-C	1.1/2"				100	11,3655
062222-C	1/2" x 2 cm	8431977204771	25		500	2,6076
062322-C	1/2" x 3 cm	8431977208571	25		400	3,1611



- PARA JUNTA PLANA · POUR JOINT PLAT · FOR FLAT SEAL
- ДЛЯ ПЛОСКОГО УПЛОТНЕНИЯ · DO USZCZELKI PŁASKIEJ

062001-JPF	3/8"	8431977211021	10		500	1,1551
062002-JPF	1/2"	8431977210949	10		500	1,5166
062003-JPF	3/4"	8431977210994	10		300	2,4129
062004-JPF	1"	8431977211014	10		150	3,7398



62R

- RACOR MARSELLA REDUCIDO
- MAMELON RÉDUIT MF · REDUCING HEX UNION MF
- ПЕРЕХОДНИК Н-В РЕДУКЦИОННЫЙ · PRZEDŁUŻKA SZEŚCIOKĄTNA GZ/GW REDUKCYJNA



CODE



€

· M REDUCIDO

· M Réduit · Reduction M · Н редуционный · Z redukcijne

0621211	M 1/8" x H 1/4"	8431977200681	25	1000	1,2889
062121	M 1/8" x H 3/8"	8431977202241	25	1000	1,9787
062111	M 1/4" x H 3/8"	8431977200667	25	1000	1,4361
062112	M 3/8" x H 1/2"	8431977200674	25	800	1,3861
062233	M 1/2" x H 3/4"	8431977200728	25	500	1,9973
062204	M 1/2" x H 1"	8431977200698	10	300	3,1503
062205	M 1/2" x H 1.1/4"				10,3860
062354	M 3/4" x H 1"	8431977200759	10	250	3,5010
062305	M 3/4" x H 1.1/4"	8431977203422	10	200	5,3672
062307	M 3/4" x H 2"	8431977209677	15	75	11,0162
062405	M 1" x H 1.1/4"	8431977200766	10	150	5,5047
062406	M 1" x H 1.1/2"	8431977203286	10	120	7,7591
062407	M 1" x H 2"	8431977209684	15	75	11,9193
062506	M 1.1/4" x H 1.1/2"	8431977204405	5	120	8,3866
062507	M 1.1/4" x H 2"	8431977209660	15	75	12,0327
062607	M 1.1/2" x H 2"	8431977205525	5	80	11,6840
062609	M 1.1/2" x H 3"				30,5884
062708	M 2" x H 2.1/2"	8431977213940	6	30	23,4168

· M REDUCIDO CROMADO

· M Réduit Chromé · Reduction M Chrome · В редуционный хром · Z redukcijne chrom



062112-C	M 3/8" x H 1/2"	8431977204788	25	800	1,9019
062233-C	M 1/2" x H 3/4"	8431977204795	25	500	2,6252
062204-C	M 1/2" x H 1"	8431977207758	10	300	4,6009
062354-C	M 3/4" x H 1"	8431977205693	10	250	4,9551
062506-C	M 1.1/4" x H 1.1/2"			120	10,7588

· M REDUCIDO PARA JUNTA PLANA

· M Réduit pour joint plat · Reduction M for flat seal

· Н редуционный для плоского уплотнения · Z redukcijne do uszczelki płaskiej

062112-JPF	M 3/8" x H 1/2"	8431977210956	10	500	1,3861
062103-JPF	M 3/8" x H 3/4"	8431977212530	10		1,8530
062233-JPF	M 1/2" x H 3/4"	8431977210932	10	400	1,9973
062204-JPF	M 1/2" x H 1"				3,1503
062354-JPF	M 3/4" x H 1"	8431977211007	10	200	3,5010



· H REDUCIDO

· F Réduit · Reduction F · В редуционный · W redukcijne

0621112	M 1/4" x H 1/8"	8431977203439	25	1000	1,1921
062100	M 3/8" x H 1/4"	8431977200650	25	1000	1,5693
062221	M 1/2" x H 3/8"	8431977200704	25	800	1,4131
062342	M 3/4" x H 1/2"	8431977200742	25	500	2,5157
062463	M 1" x H 3/4"	8431977200773	10	250	3,9200

· H REDUCIDO CROMADO

· F Réduit chromé · Reduction F chrome · В редуционный хром · W redukcijne chrome

062221-C	M 1/2" x H 3/8"	8431977210314	25	800	1,9395
062342-C	M 3/4" x H 1/2"	8431977207673	25	500	3,1588
062463-C	M 1" x H 3/4"			250	5,4673



63

- ALARGO CILÍNDRICO MH CON ALETAS
- RALLONGE CILINDRIQUE MF À AILETTE · CYLINDRICAL EXTENSION MF WITH RIDGES
- УДЛИНИТЕЛЬНАЯ ГАЙКА Н-В С ВЫСТУПАМИ · PRZEDŁUŻKA GZ/GW



CODE	←→					€
06300112	M3/8" x H3/8" x 12	8431977204337	25		750	1,5310
06300210	M1/2" x H1/2" x 10	8431977204344	25		600	1,3680
06300215	M1/2" x H1/2" x 15	8431977204351	25		500	1,5816
06300220	M1/2" x H1/2" x 20	8431977204382	25		500	1,8702
06300225	M1/2" x H1/2" x 25	8431977204436	25		300	2,0375
06300230	M1/2" x H1/2" x 30	8431977204443	10		300	2,3971
06300240	M1/2" x H1/2" x 40	8431977204450	10		250	2,7993
06300250	M1/2" x H1/2" x 50	8431977204467	10		200	3,4485
06300315	M3/4" x H3/4" x 15	8431977204368	25		300	2,5265
06300330	M3/4" x H3/4" x 30	8431977204412	10		200	3,4239
06300420	M1" x H1" x 20	8431977204429	10		150	3,9884

- CROMO · Chromé · Chrome · Хромированный · Chrom

06300112-C	M3/8" x H3/8" x 12				750	2,3634
06300210-C	M1/2" x H1/2" x 10	8431977209127	25		600	2,2125
06300215-C	M1/2" x H1/2" x 15	8431977209134	25		500	2,5085
06300220-C	M1/2" x H1/2" x 20	8431977209141	25		500	2,7893
06300225-C	M1/2" x H1/2" x 25	8431977209158	25		300	2,9281
06300230-C	M1/2" x H1/2" x 30	8431977209165	10		300	3,3504
06300240-C	M1/2" x H1/2" x 40	8431977209172	10		250	3,7737
06300250-C	M1/2" x H1/2" x 50	8431977209189	10		200	4,4796
06300315-C	M3/4" x H3/4" x 15	8431977210161	25		300	3,4898
06300330-C	M3/4" x H3/4" x 30	8431977210178	10		200	4,4604

39

- ALARGO CILÍNDRICO MH REFORZADO
- RALLONGE CILINDRIQUE MF RENFORCÉ · CYLINDRICAL EXTENSION MF HEAVY DUTY
- УДЛИНИТЕЛЬ ЦИЛИНДРИЧЕСКИЙ УКРЕПЛЕННЫЙ НР - ВР · PRZEDŁUŻKA GZ/GW, WZMOCNIONA



CODE	←→					€
03900212	M1/2" x H1/2" x 12,5	8431977213230	30		360	2,9934
03900220	M1/2" x H1/2" x 20	8431977213247	30		360	3,5907
03900225	M1/2" x H1/2" x 25	8431977213254	15		180	5,1099
03900230	M1/2" x H1/2" x 30	8431977213261	15		180	5,5152
03900240	M1/2" x H1/2" x 40	8431977213278	15		180	6,4327
03900250	M1/2" x H1/2" x 50	8431977213285	10		120	7,7811
03900265	M1/2" x H1/2" x 65	8431977213292	10		120	9,6404
03900280	M1/2" x H1/2" x 80	8431977213308	10		120	11,3336

- CROMO · Chromé · Chrome · Хромированный · Chrom



03900212-C	M1/2" x H1/2" x 12,5	8431977213315	30		360	4,0213
03900220-C	M1/2" x H1/2" x 20	8431977213322	30		360	4,6741
03900225-C	M1/2" x H1/2" x 25	8431977213339	15		180	6,3456
03900230-C	M1/2" x H1/2" x 30	8431977213346	15		180	6,7816
03900240-C	M1/2" x H1/2" x 40	8431977213353	15		180	7,7878
03900250-C	M1/2" x H1/2" x 50	8431977213360	10		120	9,2918
03900265-C	M1/2" x H1/2" x 65	8431977213377	10		120	11,3871
03900280-C	M1/2" x H1/2" x 80	8431977213384	10		120	13,3644



- ARO REDUCIDO MH CON VALONA HEXAGONAL
- BAGUE RÉDUCTION MF À COLLERETTE · REDUCING HEX. BUSH MF
- ФУТОРКА · REDUKCJA SZEŚCIOKĄTNA GZ/GW

75

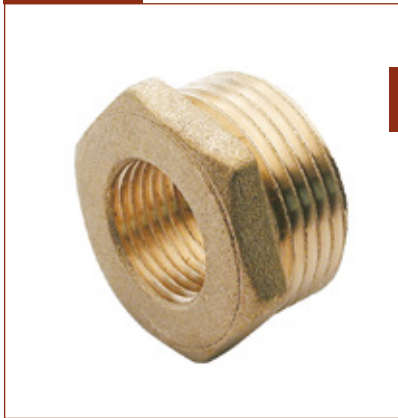

CODE	↔	Barcode	⊗	□	⊞	€
0751112	1/4" x 1/8"	8431977201244	25		1000	1,2869
075112	3/8" x 1/8"	8431977201251	25		1000	1,1208
075111	3/8" x 1/4"	8431977201237	25		1000	0,9988
075212	1/2" x 1/8"	8431977201282	25		1000	1,8031
075211	1/2" x 1/4"	8431977201275	25		1000	1,3724
075201	1/2" x 3/8"	8431977201268	25		1000	1,2354
075301	3/4" x 3/8"	8431977208472	25		400	1,7805
075302	3/4" x 1/2"	8431977201299	25		750	1,5287
075402	1" x 1/2"	8431977201305	25		400	3,0423
075403	1" x 3/4"	8431977202029	25		400	2,5420
075502	1.1/4" x 1/2"	8431977201329	10		250	5,6628
075503	1.1/4" x 3/4"	8431977203637	10		250	5,5311
075504	1.1/4" x 1"	8431977201343	10		250	4,6046
075602	1.1/2" x 1/2"	8431977201350	10		150	6,8346
075603	1.1/2" x 3/4"	8431977201367	10		150	6,5727
075604	1.1/2" x 1"	8431977201374	10		150	6,7529
075605	1.1/2" x 1.1/4"	8431977201381	10		150	5,1514
075702	2" x 1/2"	8431977205518	5		100	12,0479
075703	2" x 3/4"	8431977205549	5		100	12,8330
075704	2" x 1"	8431977205471	5		100	12,3201
075705	2" x 1.1/4"	8431977205488	5		60	12,7097
075706	2" x 1.1/2"	8431977205495	5		100	10,0024
075804	2.1/2" x 1"					26,8024
075805	2.1/2" x 1.1/4"					25,2297
075806	2.1/2" x 1.1/2"				50	23,3384
075807	2.1/2" x 2"				50	21,4335
075905	3" x 1.1/4"					49,5067
075906	3" x 1.1/2"					47,5956
075907	3" x 2"				30	40,9831
075908	3" x 2.1/2"				30	33,1295
075407	4" x 2"				15	85,5320
075408	4" x 2.1/2"				15	81,8037
075409	4" x 3"				15	79,5597

- CROMO · Chromé · Chrome · Хромированный · Chrom

075111-C	3/8" x 1/4"				1000	1,5062
075212-C	1/2" x 1/8"				1000	2,3697
075211-C	1/2" x 1/4"				1000	1,8593
075201-C	1/2" x 3/8"	8431977204276	25		1000	1,6545
075302-C	3/4" x 1/2"	8431977205716	25		750	2,0093
075402-C	1" x 1/2"	8431977206461	25		400	4,4416
075403-C	1" x 3/4"	8431977205723	25		400	3,9370
075704-C	2" x 1"				100	15,9556

77

- ANILLO ROSCADO
- ANNEAU FILETÉ · THREADED RING · РЕЗЬБОВОЕ КОЛЬЦО · PIERŚCIEŃ GWINTOWANY



CODE	↔	Barcode	⊗	□	⊞	€
077133	7/8" x 3/4"					4,2279



Nuevo · Nouvelle
New · новый · Nowy



69

· TAPÓN MACHO
· BOUCHON MÂLE · FLANGED PLUG HEX. HEAD · ЗАГЛУШКА НР · KOREK Z KOŁNIERZEM

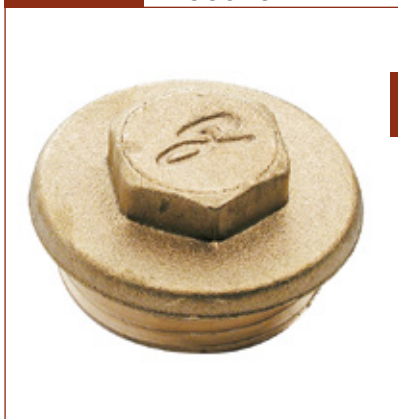

CODE	↔	Barcode	⊘	□	⊞	€
069012	1/8"	8431977201176	25		1000	0,7843
069011	1/4"	8431977201169	25		1000	0,8884
069001	3/8"	8431977201077	25		1000	0,9650
069002	1/2"	8431977201084	25		1000	1,1468
069003	3/4"	8431977201107	25		600	1,8039
069004	1"	8431977201138	25		400	2,8257
069005	1.1/4"	8431977201145	10		250	4,0911
069006	1.1/2"	8431977201152	10		180	5,9736
069007	2"	8431977204856	5		100	8,5718
069008	2.1/2"				55	18,5325
069009	3"				50	24,4435
069040	4"				20	85,0863

· CROMO · Chromé · Chrome · Хромированный · Chrom

069001-C	3/8"	8431977202937	25		1000	1,4228
069002-C	1/2"	8431977202616	25		1000	1,6263
069003-C	3/4"	8431977201114	25		600	2,3554
069004-C	1"	8431977203057	25		400	4,3900
069005-C	1.1/4"	8431977214107	10		250	5,6559
069006-C	1.1/2"	8431977214534	10		180	8,3259



· CON PRECINTO · Avec trou pour scellé · With seal hole · С пломбой · Z otworem na plombę

069001-P	3/8"				1000	1,5173
069002-P	1/2"	8431977201091	25		1000	1,8293
069003-P	3/4"	8431977201121	25		600	2,1281
069013-P	7/8"	8431977201183	25		400	2,3573
069004-P	1"	8431977205730	25		400	4,0611
069005-P	1.1/4"	8431977205747	10		250	4,5099
069006-P	1.1/2"				180	6,4572
069007-P	2"				100	9,4575

76

· TAPÓN MACHO SIN VALONA
· BOUCHON MÂLE SANS COLLERETTE · PLUG WITHOUT FLANGE
· ЗАГЛУШКА С НАРУЖНОЙ РЕЗЬБОЙ БЕЗ УПОРА · KOREK BEZ KOŁNIERZA



CODE	↔	Barcode	⊘	□	⊞	€
076001	3/8"	8431977210673	10		1100	0,9203
076002	1/2"	8431977210680	10		1000	1,0573
076003	3/4"	8431977210697	10		600	1,4618
076004	1"	8431977210703	10		400	2,2363

· CROMO · Chromé · Chrome · Хромированный · Chrom

076001-C	3/8"					1,3564
076002-C	1/2"					1,5316
076003-C	3/4"					1,9877



44

· TAPÓN HEMBRA
· BOUCHON FEMELLE · BLANKING CAP · ЗАГЛУШКА ВР · ZAŚLEPKA



CODE	↔	Barcode	⊖	□	⊞	€
044001	3/8"	8431977200445	25		1000	0,8259
044002	1/2"	8431977200452	25		1000	1,1195
044003	3/4"	8431977200476	25		700	1,5161
044004	1"	8431977200490	10		400	2,5020
044005	1.1/4"	8431977200506	10		250	4,1118
044006	1.1/2"	8431977200513	10		200	5,0856
044007	2"	8431977205969	5		120	8,9866
044008	2.1/2"				75	15,2917
044009	3"				45	24,5599
044040	4"					98,2039

· CROMO · Chromé · Chrome · Хромированный · Chrom

044001-C	3/8"	8431977206515	25		1000	1,2737
044002-C	1/2"	8431977206522	25		1000	1,6013
044003-C	3/4"	8431977206508	25		800	2,0325
044004-C	1"	8431977210185	10		400	3,8518



· CON PRECINTO · Avec trou pour scellé · With seal hole · С пломбой · Z otworem na plombę

044002-P	1/2"	8431977200469	25		1000	1,3994
044003-P	3/4"	8431977200483	25		800	1,7929
044013-P	7/8"	8431977209028	25			2,4679
044004-P	1"	8431977208755	10		400	2,9651
044005-P	1.1/4"	8431977208762	10		250	4,5128
044006-P	1.1/2"	8431977209011	10		200	5,9249
044007-P	2"	8431977210833	5		120	9,9151

441

· TUERCA
· ECROU · NUT · ГАЙКА · НАКРĘТКА



CODE	↔	Barcode	⊖	□	⊞	€
044101	3/8"					0,8382
044102	1/2"					1,1883
044103	3/4"	8431977210079	25		750	1,5508
044113	7/8"					2,2036
044104	1"	8431977210086	25		500	2,2726
044105	1.1/4"	8431977210000	10		300	3,4178
044106	1.1/2"	8431977210017	10		250	4,9834
044107	2"	8431977210093	10		150	7,2457
044108	2.1/2"				75	13,7587
044109	2.1/4"					9,9274
044132	3.1/2"					35,3400
044140	4"					77,6437

· CROMO · Chromé · Chrome · Хромированный · Chrom

044101-C	3/8"					1,2112
044102-C	1/2"				750	1,6729
044103-C	3/4"				500	2,0384



Nuevo · Nouvelle
New · новый · Nowy



49

· TUERCA CORREDERA CON VALONA
· ECROU À COLLERETTE · FLANGED BACK NUT · КОНТРАГАЙКА · NAKRĘTKA KOŁNIERZOWA



CODE	↔		○	□	☒	€
049001	3/8"	8431977205419	100		1500	0,6060
049002	1/2"	8431977205426	50		1200	0,7220
049003	3/4"	8431977205433	50		700	1,2460
049004	1"	8431977205150	25		600	1,3636
049005	1.1/4"	8431977205631	25		400	2,2989
049006	1.1/2"	8431977205457	10		200	2,9163
049007	2"	8431977205464	10		125	9,4839
049008	2.1/2"					21,8716
049009	3"					24,8367

· CROMO · Chromé · Chrome · Хромированный · Chrom

049001-C	3/8"	8431977214695	100			1,1134
049002-C	1/2"	8431977209325	50		1200	1,2338
049003-C	3/4"	8431977209332	50		700	1,7876
049004-C	1"	8431977209349	25		600	2,4843
049005-C	1.1/4"	8431977209356	25		400	3,5248

14

· TUERCA CON PRECINTO PARA CONO CONTADOR
· ECROU AVEC TROU POUR SCELLÉ POUR CONE COMPTEUR · NUT WITH SEAL HOLE FOR METER CONE
· ГАЙКА С ПЛОМБОЙ · NAKRĘTKA DO PÓŁSRUBUNKU Z OTWOREM NA PLOMBĘ



CODE	↔		○	□	☒	€
014003	3/4"	8431977204504	25		750	1,7739
014013	7/8"	8431977208496	25		400	2,2474
014004	1"	8431977205754	10		500	2,3575
014005	1.1/4"				300	3,9463
014006	1.1/2"				250	5,0469
014007	2"				150	8,5572



15

· RACOR CONTADOR

· RACCORD COMPTEUR · METER SET · КОМПЛЕКТ ПЕРЕХОДНИК · KOMPLET PÓŁSRUBUNKU



CODE



€

· CONO CONTADOR · Cone compteur · Meter cone · Конусный переходник · Trzpień półsrubunku

015003	1/2" para tuerca 3/4"	8431977204511	25	500	2,1696
015013	1/2" para tuerca 7/8"	8431977208502	25		2,2559
015004	3/4" para tuerca 1"	8431977205761	10		3,3440
015005	1" para tuerca 1.1/4"				4,7585



· JUNTA · Joint · Rubber joint · Прокладка · Uszczelka gumowa

015003-G	3/4"				0,1964
015013-G	7/8"				0,2257
015004-G	1"				0,3433
015005-G	1.1/4"				0,5442

· CON JUNTA Y TUERCA CON PRECINTO

· Cone compteur, joint et ecrou compteur · Meter cone, joint and meter nut

· Комплект: гайка, конусный переходник, прокладка · Zestaw: nakrętka, trzpień, uszczelka



015203	1/2" x 3/4"			200	4,3099
015213	1/2" x 7/8"			200	4,9818
015304	3/4" x 1"			150	6,7067
015405	1" x 1.1/4"				9,1244

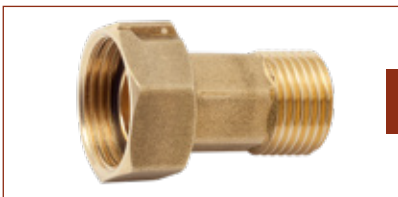

· ECONÓMICO · Economique · Light pattern · Эконом. · Wersja ekonomiczna

015203-E	1/2" x 3/4"				3,9958
----------	-------------	--	--	--	--------



· CONO CONTADOR JUNTA PLANA · Cone comteur à joint plat · Meter cone with flat seal

· Конусный переходник с плоским уплотнением · Trzpień półsrubunku na uszczelkę płaską

015003-JP	1/2" para tuerca 3/4"	8431977712894	25	500	2,1696
015013-JP	1/2" para tuerca 7/8"	8431977701591	25		2,4231
015004-JP	3/4" para tuerca 1"	8431977701539	10		3,3440
015005-JP	1" para tuerca 1.1/4"				4,7585

· CONO CONTADOR JUNTA PLANA, JUNTA Y TUERCA CON PRECINTO

· Cone compteur joint plat, joint et ecrou compteur · meter cone flat seal, joint and meter nut

· Гайка, прокладка, конусный переходник с плоским уплотнением

· Półsrubunek do wodomierza na płaską uszczelkę



015203-JP	1/2" x 3/4"			200	4,3099
015213-JP	1/2" x 7/8"			200	4,9818
015304-JP	3/4" x 1"			150	6,7067
015405-JP	1" x 1.1/4"			75	9,2935
015506-JP	1.1/4" x 1.1/2"				20,9694

· CON VÁLVULA ANTIRRETORNO

· Avec clapet de retenue · With non-return valve · С обратным клапаном · Z zaworem zwrotnym



015023	1/2" para tuerca 3/4"				7,1444
015034	3/4" para tuerca 1"				10,4062





131

· RACOR NÁUTICO PASACASCOS
· PASSE COQUES POUR BATEAU · MARINE THRU-HULL FITTING
· СУДОВОЙ ПАТРУБОК · PRZEJŚCIE KADŁUBOWE



CODE	↔		⊖	□	⊞	€
131001	3/8" - 55 mm					9,2715
131002	1/2" - 65 mm					10,2427
131003	3/4" - 68 mm					15,4034
131004	1" - 84 mm					20,7794
131005	1.1/4" - 84 mm					27,5187
131006	1.1/2" - 85 mm					33,1423
131007	2" - 90 mm					53,0565



· JUNTA PLANA · Joint plat · Flat seal · Плоское уплотнение · Uszczelką płaską						
131001-G	3/8" (16x30x2 mm)					1,0886
131002-G	1/2" (20x45x2 mm)					1,2530
131003-G	3/4" (25x59x2 mm)					1,2885
131004-G	1" (30x70x2 mm)					1,4611
131005-G	1.1/4" (36x70x2 mm)					1,5294
131006-G	1.1/2" (40x77x2 mm)					1,8537
131007-G	2" (54x77x2 mm)					1,7512



31

· RACOR PARA DEPÓSITO
· RACCORD PASSAGE À LA CUVE · TANK CONNECTOR · ПЕРЕХОДНИК · ZŁĄCZKA ZBIORNIKOWA



CODE



· CUERPO CON TUERCA CORREDERA

· Corps avec écrou à collerette · Body with flanged back nut

· Переходник с контрагайкой · Korpus, vxznakrętka kołnierзова

031001-M	3/8"	8431977205952	10	500	2,9271
031002-M	1/2"	8431977205556	10	300	3,7120
031003-M	3/4"	8431977205501	10	200	5,5895
031004-M	1"	8431977205563	10	120	7,2637
031005-M	1.1/4"			80	11,8938
031006-M	1.1/2"			50	17,5870
031007-M	2"			20	32,1597
031008-M	2.1/2"				57,3517
031009-M	3"				86,9216



· CUERPO · Corps · Body · Переходник · Korpus

031101	3/8"				2,0181
031102	1/2"				2,7870
031103	3/4"				3,8961
031104	1"				5,5860
031105	1.1/4"				9,3145
031106	1.1/2"				13,5117
031107	2"				22,6788
031108	2.1/2"				34,8051
031109	3"				62,0562



· ARANDELA DE LATÓN · Rondelle en laiton · Brass washer

· Латунная кольцевая прокладка · Podkładka miedziana

031001-AL	3/8"	8431977215807	100		0,9330
031002-AL	1/2"	8431977215821	100		1,1717
031003-AL	3/4"	8431977215845	100		1,1954
031004-AL	1"	8431977215869	100		2,0805
031005-AL	1.1/4"	8431977215883	50		3,0329
031006-AL	1.1/2"	8431977215906	25		3,9497
031007-AL	2"	8431977215913	25		3,9485



· ARANDELA DE HIERRO GALVANIZADA · Rondelle fer galvanisé · Galvanised iron washer

· Металлическая кольцевая прокладка · Podkładka stalowa galvanizowana

031001-AG	3/8"	8431977215791	100		0,2474
031002-AG	1/2"	8431977215814	100		0,2734
031003-AG	3/4"	8431977215838	100		0,3236
031004-AG	1"	8431977215852	100		0,4927
031005-AG	1.1/4"	8431977215876	50		0,5783
031006-AG	1.1/2"	8431977215890	25		0,7516
031007-AG	2"	8431977215784	25		1,0662



66

· MANGUITO HH
· MANCHON FF · SOCKET F.I. F.I. · МУФТА · MUFA



CODE	↔	Barcode	⊗	□	⊞	€
066001	3/8"	8431977200834	25		500	1,9052
066002	1/2"	8431977200841	25		500	2,2068
066003	3/4"	8431977200858	10		250	3,1830
066004	1"	8431977200865	10		150	4,6994
066005	1.1/4"	8431977204290	5		100	8,3061
066006	1.1/2"	8431977205372	5		70	11,5631
066007	2"				30	20,7590
066008	2.1/2"				25	41,8740
066009	3"				15	68,2283
066040	4"				10	128,8652

· CROMO · Chromé · Chrome · Хромированный · Chrom

066001-C	3/8"	8431977204818	25		500	2,7126
066002-C	1/2"	8431977205099	25		500	3,0299
066003-C	3/4"	8431977205679	10		250	4,1210
066004-C	1"	8431977206492	10		150	6,3198
066005-C	1.1/4"	8431977207802	5		100	10,4962
066006-C	1.1/2"				70	14,7238
066007-C	2"				30	24,8598

· ECONÓMICO · Economique · Light pattern · Эконом. · Wersja ekonomiczna

066002-E	1/2"	8431977203682	25		300	1,8586
----------	------	---------------	----	--	-----	--------

65

· MANGUITO REDUCIDO HH
· MANCHON RÉDUIT FF · REDUCING SOCKET F.I. - F.I. · МУФТА ПЕРЕХОДНАЯ · MUFA REDUKCYJNA



CODE	↔	Barcode	⊗	□	⊞	€
065102	3/8" x 1/2"	8431977200797	25		500	1,9861
065203	1/2" x 3/4"	8431977200803	10		300	3,3266
065204	1/2" x 1"	8431977200810	10		200	3,5823
065304	3/4" x 1"	8431977200827	10		200	3,8819
065405	1" x 1.1/4"	8431977201718	10		120	6,2093
065407	1" x 2"				60	11,7641
065506	1.1/4" x 1.1/2"	8431977204283	5		75	8,9447
065507	1.1/4" x 2"				50	12,5187
065607	1.1/2" x 2"				50	13,9541

· CROMO · Chromé · Chrome · Хромированный · Chrom

065102-C	3/8" x 1/2"	8431977207765	25		500	2,7039
065203-C	1/2" x 3/4"	8431977207772	10		300	4,2886
065204-C	1/2" x 1"	8431977207789	10		200	5,0881
065304-C	3/4" x 1"	8431977207796	10		200	5,4838
065405-C	1" x 1.1/4"				120	8,4522

· ECONÓMICO · Economique · Light pattern · Эконом. · Wersja ekonomiczna

065102-E	3/8" x 1/2"	8431977206423	25		500	1,9472
065203-E	1/2" x 3/4"	8431977204559	25		300	2,6668
065204-E	1/2" x 1"	8431977205297	10		150	3,4031
065304-E	3/4" x 1"	8431977205303	10		150	3,6878

· CON ALETAS · À ailette · With ridges · С выступами · Z nadlewami pod narzędzie

065203-PL	1/2" x 3/4"	8431977204474	25		300	1,9303
-----------	-------------	---------------	----	--	-----	--------





8

· MANGUITO HEXAGONAL
· HEXAGONAL MANCHON FF · HEXAGONAL SOCKET FF
· МУФТА · MUFA SZEŚCIOKĄTNA



CODE	↔	Barcode	🔗	📏	🏠	€
008001	3/8"	8431977214824	10	600	1,2003	
008002	1/2"	8431977214831	10	500	1,4885	
008003	3/4"	8431977214848	10	300	2,2603	
008004	1"	8431977214855	10	200	3,4375	

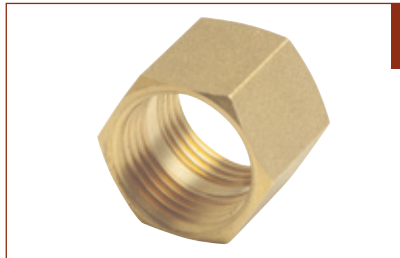

· SIN TOPE · Sans Butée · Without stop · Без остановки · Bez stopu

008011-ST	1/4"				3,0382
-----------	------	--	--	--	--------

● Nuevo · Nouvelle
New · новый · Nowy

67

· CODO HH
· COUDE FF · ELBOW FF · УГОЛОК BP - BP · KOLANO GW/GW



CODE	↔	Barcode	🔗	📏	🏠	€
067011	1/4"	8431977215449	10		1,9908	
067001	3/8"	8431977200872	25	500	2,1953	
067002	1/2"	8431977200896	25	300	3,3442	
067003	3/4"	8431977200933	10	200	5,0162	
067004	1"	8431977200964	10	100	9,1608	
067005	1.1/4"			65	15,0113	
067006	1.1/2"			45	21,2691	
067007	2"			25	31,4903	
067008	2.1/2"			12	65,1616	
067009	3"			8	107,9465	
067040	4"			3	185,1352	

· CROMO · Chromé · Chrome · Хромированный · Chrom

067001-C	3/8"	8431977204832	25	500	3,1237
067002-C	1/2"	8431977204757	25	300	4,3952
067003-C	3/4"	8431977205648	10	200	6,2739
067004-C	1"	8431977206485	10	100	12,0398
067005-C	1.1/4"			65	18,5034
067006-C	1.1/2"			45	25,6358
067007-C	2"			25	36,6137
067008-C	2.1/2"			12	72,7506
067009-C	3"			8	117,8003



· ECONÓMICO · Economique · Light pattern · Эконом. · Wersja ekonomiczna

067002-E	1/2"	8431977200902	25	250	2,7683
----------	------	---------------	----	-----	--------

93

· CODO REDUCIDO HH
· COUDE RÉDUIT FF · REDUCING ELBOW FF · УГОЛОК ПЕРЕХОДНОЙ BP - BP · KOLANO REDUKCYJNE GW/GW



CODE	↔	Barcode	🔗	📏	🏠	€
093102	3/8" x 1/2"	8431977201398	10	250	3,1851	
093203	1/2" x 3/4"	8431977201404	10	200	5,0579	
093204	1/2" x 1"	8431977201411	10	120	6,3316	
093304	3/4" x 1"	8431977201428	10	120	7,2111	



94

· CODO MM
· COUDE MM · ELBOW MM · УГОЛОК HP · KOLANO GZ/GZ



CODE	↔	Barcode	Ø	□	田	€
094001	3/8"	8431977203019	10		750	1,9424
094002	1/2"	8431977203026	10		500	2,4038
094003	3/4"	8431977203033	10		200	3,3513
094004	1"	8431977203040	10		150	6,3254
094005	1.1/4"				80	17,9924
094006	1.1/2"				60	19,6489
094007	2"				40	31,0812

· ECONÓMICO · Economique · Light pattern · Эконом. · Wersja ekonomiczna

094001-E	3/8"	8431977210840	10			1,7062
094002-E	1/2"	8431977210857	10		300	2,1524
094003-E	3/4"	8431977210802	10		200	3,0939
094004-E	1"	8431977210864	10		150	5,8661

67MH

· CODO MH
· COUDE MF · ELBOW MF · УГОЛОК HP - BP · KOLANO GW/GZ



CODE	↔	Barcode	Ø	□	田	€
067011-MH	1/4"	8431977210741	10			1,8063
067001-MH	3/8"	8431977200889	25		500	2,1264
067002-MH	1/2"	8431977200919	25		300	3,4087
067003-MH	3/4"	8431977200940	10		150	5,4350
067004-MH	1"	8431977200971	10		100	8,9665
067005-MH	1.1/4"				65	14,6281
067006-MH	1.1/2"				45	22,2317
067007-MH	2"				25	30,1770
067008-MH	2.1/2"				12	79,2923
067009-MH	3"				8	116,5001
067040-MH	4"				3	202,8937

· CROMO · Chromé · Chrome · Хромированный · Chrom

067001-MHC	3/8"	8431977204825	25		500	3,1364
067002-MHC	1/2"	8431977204627	25		300	4,4803
067003-MHC	3/4"	8431977205655	10		150	6,8241
067004-MHC	1"	8431977206478	10		100	11,7846
067005-MHC	1.1/4"				65	18,0977
067006-MHC	1.1/2"				45	27,1470
067007-MHC	2"				25	35,0566
067008-MHC	2.1/2"				12	86,8286
067040-MHC	4"				3	218,6144

· ECONÓMICO · Economique · Light pattern · Эконом. · Wersja ekonomiczna

067002-MHE	1/2"	8431977200926	25		250	2,7508
------------	------	---------------	----	--	-----	--------



67MHR

· CODO REDUCIDO MH · COUDE RÉDUIT MF · REDUCING ELBOW MF
· УГОЛОК ПЕРЕХОДНОЙ РЕДУКЦ. НР - ВР · KOLANO GW/GZ REDUKCYJNE



CODE	↔		○	□	☐	€
· M REDUCIDO · M réduit · Reduction M · Наружная резьба меньше, чем внутр · Z redukcijne						
067203	M 1/2" x H 3/4"	8431977200988	10		200	5,1290
067304	M 3/4" x H 1"	8431977200995	10		120	8,7272
067405	M 1" x H 1.1/4"				80	15,2922



· ECONÓMICO · Economique · Light pattern · Эконом. · Wersja ekonomiczna						
067203-E	M 1/2" x H 3/4"	8431977203699	10		200	3,8180



· H REDUCIDO · F réduit · Reduction F · Внутренняя резьба меньше, чем нар · W redukcijne						
067302	M 3/4" x H 1/2"					4,8672
067403	M 1" x H 3/4"					8,2906

91

· CODO MURAL HH
· APPLIQUE COUDE FF · FF WALL PLATE ELBOW · УГОЛОК НАСТЕННЫЙ ВР · KOLANO GW/GW ZE STOPĄ



CODE	↔		○	□	☐	€
· ECONÓMICO · Economique · Light pattern · Эконом. · Wersja ekonomiczna						
091002-E	1/2" x 1/2"	8431977202708	10		200	3,5901

58

· CODO TRES BOCAS
· COUDE À TROIS SORTIES · CORNER ELBOW F.I. · ТРОЙНИК ТРЕХОСЕВОЙ (90°) · TRÓJNIK NAROŻNIKOWY GW



CODE	↔		○	□	☐	€
058002	1/2"	8431977204528	10		200	7,0050
058003	3/4"	8431977204535	10		100	11,8512



64

· CURVA HH
· COURBE FF · BEND F.I. - F.I. · УГОЛОК ДУГА ВР - ВР · ŁUK GW/GW



CODE	↔	Barcode	⊗	□	⊞	€
064002	1/2"	8431977200780	10		200	7,8224
064003	3/4"	8431977211625	10		100	11,9400
064004	1"				60	19,5664
064005	1.1/4"				30	39,0543
064006	1.1/2"				20	47,4685
064007	2"				10	80,1357

67U

· CURVA MH
· COURBE MF · MF BEND · УГОЛОК ДУГА ВР - НР · ŁUK GW/GZ

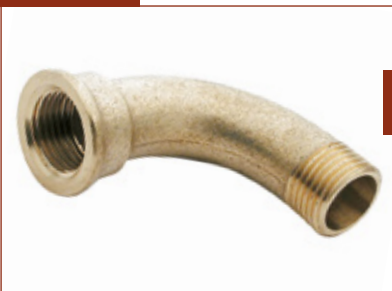

CODE	↔	Barcode	⊗	□	⊞	€
067002-U	1/2"	8431977203675	10		200	6,6452
067003-U	3/4"	8431977201312	10		125	10,7526
067004-U	1"				75	17,9590
067005-U	1.1/4"				30	35,3152
067006-U	1.1/2"				20	41,7053
067007-U	2"				10	81,8765

59

· CRUZ
· CROIX FEMELLE · EQUAL CROSS F.I. · КРЕСТОВИНА ВР · CZWÓRNIK GW



CODE	↔	Barcode	⊗	□	⊞	€
059011	1/4"	8431977200582	10			5,3991
059001	3/8"	8431977203668	10		250	4,7293
059002	1/2"	8431977200551	10		200	5,1429
059003	3/4"	8431977200568	10		80	9,8736
059004	1"	8431977200575	5		60	15,5601
059005	1.1/4"				30	30,9582
059006	1.1/2"				20	37,2374
059007	2"				12	54,4202

· CROMO · Chromé · Chrome · Хромированный · Chrom

059002-C	1/2"	8431977207734	10		200	6,7595
----------	------	---------------	----	--	-----	--------

59R

· CRUZ REDUCIDA
· CROIX RÉDUIT · REDUCING CROSS F.I. · КРЕСТОВИНА РЕДУКЦИОННАЯ · CZWÓRNIK REDUKCYJNY GW



CODE	↔	Barcode	⊗	□	⊞	€
0593322	3/4" x 3/4" x 1/2" x 1/2"				60	10,1379



38

CRUZ MACHO

CROIX MÂLE - EQUAL CROSS M.I. · КРЕСТОВИНА НР · CZWÓRNIK GZ



CODE	↔	Barcode	Ø	□	田	€
038003	3/4"	8431977213612	10		100	14,2900

4

· RACOR Y

· RACCORD Y · Y FITTING · ТРОЙНИК Y-ОБРАЗНЫЙ · ZŁĄCZKA "Y"



CODE	↔	Barcode	Ø	□	田	€
· HHH · FFF · FFF · BBB · WWW						
004001	H 3/8"	8431977209394	10			6,2930
004002	H 1/2"	8431977701140	10		200	7,3273



CODE	↔	Barcode	Ø	□	田	€
· MHH · MFF · MFF · HBB · ZWW						
004222	M 1/2"	8431977205327	10		200	5,7363



68

· TE HEMBRA
· TÉ ÉGAL FFF · EQUAL TEE F.I. · ТРОЙНИК ВР · TRÓJNIK GW



CODE	↔	Barcode	Ø	□	⊞	€
068011	1/4"	8431977210772	10			2,6239
068001	3/8"	8431977201008	25	400		2,7602
068002	1/2"	8431977201015	10	200		4,0461
068003	3/4"	8431977201039	10	150		5,7188
068004	1"	8431977204573	5	75		10,1825
068005	1.1/4"			40		17,3119
068006	1.1/2"			30		28,6876
068007	2"			22		43,2078
068008	2.1/2"			10		91,4563
068009	3"			5		147,8742
068040	4"			3		240,0749

· CROMO · Chromé · Chrome · Хромированный · Chrom



068001-C	3/8"	8431977204849	25	400		4,0104
068002-C	1/2"	8431977204764	10	200		5,3178
068003-C	3/4"	8431977205341	10	150		7,5162
068004-C	1"	8431977207635	5	75		13,3827
068005-C	1.1/4"			40		21,0543
068006-C	1.1/2"			30		33,7198
068007-C	2"			22		49,4891
068008-C	2.1/2"			10		102,4260

· ECONÓMICO · Economique · Light pattern · Эконом. · Wersja ekonomiczna

068002-E	1/2"	8431977201022	10	150		3,2434
----------	------	---------------	----	-----	--	--------



· HMH · FMF · FMF · BHB · WZW

068222	H 1/2" x M 1/2" x H 1/2"	8431977203705	10	250		3,3385
--------	--------------------------	---------------	----	-----	--	--------

68R

· TE HEMBRA REDUCIDA
· TÉ RÉDUIT FFF · TEE F.I. REDUCED BRANCH · ТРОЙНИК РЕДУКЦ. ВР · TRÓJNIK REDUKCYJNY GW



CODE	↔	Barcode	Ø	□	⊞	€
068212	1/2" x 3/8" x 1/2"	8431977201749	10	250		3,6815
068323	3/4" x 1/2" x 3/4"	8431977203446	10	120		6,0089
068332	3/4" x 3/4" x 1/2"	8431977201046	10	65		9,0995
068424	1" x 1/2" x 1"	8431977204870	5	80		8,0861
068434	1" x 3/4" x 1"	8431977204887	5	80		8,6747
068525	1.1/4" x 1/2" x 1.1/4"			50		19,9174
068535	1.1/4" x 3/4" x 1.1/4"			50		18,3237
068545	1.1/4" x 1" x 1.1/4"			40		18,0826
068626	1.1/2" x 1/2" x 1.1/2"			45		20,3442
068636	1.1/2" x 3/4" x 1.1/2"			45		19,0725
068646	1.1/2" x 1" x 1.1/2"			40		19,1156
068656	1.1/2" x 1.1/4" x 1.1/2"			30		31,1485
068727	2" x 1/2" x 2"			25		34,3720
068737	2" x 3/4" x 2"			25		28,2733
068747	2" x 1" x 2"			25		27,6320
068757	2" x 1.1/4" x 2"			20		37,8172
068767	2" x 1.1/2" x 2"			18		46,2331

· MHH · MFF · MFF · HBB · ZWW

068200011	M 1/2" x H 3/8" x H 3/8"	8431977214206	10			4,3256
-----------	--------------------------	---------------	----	--	--	--------



95

· TE MMM
· TÉ ÉGAL MMM · EQUAL TEE M.I. · ТРОЙНИК НР - НР - НР · TRÓJNIK GZ



CODE	↔	Barcode	Ø	□	☒	€
095001	3/8"	8431977201473	10		500	2,3442
095002	1/2"	8431977201480	10		350	2,9464
095003	3/4"	8431977202760	10		150	4,6508
095004	1"	8431977203453	10		100	8,9701
095005	1.1/4"				40	25,9492
095006	1.1/2"				30	29,3766
095007	2"				20	43,3774

· ECONÓMICO · Economique · Light pattern · Эконом. · Wersja ekonomiczna

095001-E	3/8"	8431977210826	10		500	2,2354
095002-E	1/2"	8431977210734	10		350	2,5927
095003-E	3/4"	8431977210819	10		150	3,9491
095004-E	1"	8431977210871	10		100	7,3596

81

· TUERCA UNIÓN TRES PIEZAS HH
· RACCORD UNION 3 PIÈCES FF · CONE UNION F.I. - F.I. · ГАЙКА "АМЕРИКАНКА" BP · ŚRUBUNEK GW/GW



CODE	↔	Barcode	Ø	□	☒	€
· ESTÁNDAR CÓNICA · Standard conique - Standard conical						
· Переходник стандартный конический · Standardowy stożkowy						
081002	1/2" - tuerca 1"	8431977202609	25		125	7,7457
081003	3/4" - tuerca 1.1/4"	8431977207697	15		75	12,7359
081004	1" - tuerca 1.1/2"	8431977206614	10		50	16,0944
081005	1.1/4" - tuerca 2"	8431977208786	6		30	25,8881
081006	1.1/2" - tuerca 2.1/4"	8431977208793	5		25	32,7754
081007	2" - tuerca 2.1/2"	8431977208823	3		15	34,7026
081008	2.1/2" - tuerca 3.1/2"				10	116,4210
081009	3" - tuerca 4"				8	233,2100



· REDUCIDA CÓNICA · Réduit conique - Reducing conical						
· Переходник редукционный конический · Redukcyjny stożkowy						
081202	1/2" - tuerca 7/8"	8431977210918	10			6,3912
081203	3/4" - tuerca M38x150					10,5708
· ESTÁNDAR JUNTA PLANA · Standard joint plat - Standard flat seal						
· Стандартный с уплотнением · Standardowy uszczelka płaska						
081002-JP	1/2" - tuerca 1"					7,7457
081003-JP	3/4" - tuerca 1.1/4"					12,7359
081004-JP	1" - tuerca 1.1/2"					16,0944
081005-JP	1.1/4" - tuerca 2"					25,8881



81MH

· TUERCA UNIÓN TRES PIEZAS MH

· RACCORD UNION 3 PIÈCES MF · CONE UNION M.I. - F.I. · АМЕРИКАНКА НР - ВР · ŚRUBUNEK GW/GZ



CODE	↔	Barcode	⊖	□	⊞	€
081001-MH	3/8"	8431977210307	10			7,1740
081002-MH	1/2" - tuerca 1"	8431977208892		25	125	8,1821
081003-MH	3/4" - tuerca 1.1/4"	8431977204023		12	60	13,0270
081004-MH	1" - tuerca 1.1/2"	8431977207567		10	50	17,6114
081005-MH	1.1/4" - tuerca 2"	8431977208717		6	30	28,3663
081006-MH	1.1/2" - tuerca 2.1/4"	8431977208809		5	25	35,9219
081007-MH	2" - tuerca 2.1/2"	8431977208816		3	15	40,2039
081008-MH	2.1/2" - tuerca 3.1/2"				10	119,3418
081009-MH	3" - tuerca 4"				8	235,7586



· REDUCIDA CÓNICA · Réduit conique - Reducing conical

· Переходник редуционный конический · Redukcyjny stożkowy

081202-MH	1/2" - tuerca 7/8"	8431977210925	10			6,7386
081203-MH	3/4" - tuerca M38x150					10,8125



· ECONÓMICO CÓNICA · Economique conique · Light pattern conical

· Эконом. Коническая · Stożkowy - wersja ekonomiczna

081002-MHE	1/2" - tuerca 3/4"	8431977205167	10		200	6,1613
081003-MHE	3/4" - tuerca 1"	8431977205174	10		150	8,6889
081004-MHE	1" - tuerca 1.1/4"	8431977205181	5		75	13,6762
081005-MHE	1.1/4" - tuerca 1.1/2"	8431977212585	5			19,8710



· ECONÓMICO JUNTA PLANA · Economique joint plat · Light pattern flat seal

· Эконом. Для плоского соединения · Wersja ekonomiczna - Płaska uszczelka

081002-MHEJP	1/2" - tuerca 3/4"	8431977206539	10		200	6,1613
081003-MHEJP	3/4" - tuerca 1"	8431977206546	10		150	8,6889
081004-MHEJP	1" - tuerca 1.1/4"	8431977206553	5		75	13,6762
081005-MHEJP	1.1/4" - tuerca 1.1/2"	8431977212592	5			19,8710

81MM

· TUERCA UNIÓN TRES PIEZAS MM

· RACCORD UNION 3 PIÈCES MM · CONE UNION M.I. - M.I.

· АМЕРИКАНКА НР - НР · ŚRUBUNEK GZ/GZ



CODE	↔	Barcode	⊖	□	⊞	€
081001-MM	3/8"				200	5,6619
081002-MM	1/2"				150	6,4797
081003-MM	3/4"	8431977214862	10			9,3315
081004-MM	1"					13,6105



- CODO UNIÓN 3 PIEZAS MH
- COUDE UNION 3 PIÈCES MF · ELBOW UNION M.I.-F.I.
- АМЕРИКАНКА УГЛОВАЯ ВР-НР · KOLANO ZE ŚRUBUNKIEM GW/GZ

970



CODE



€

· CÓNICO · Conique · Conical · Коническая · Stożkowy

097002	1/2"	8431977207895	20	100	9,3619
097003	3/4"	8431977207918	15	75	13,1272
097004	1"	8431977207932	10	50	22,9253

· JUNTA PLANA · Joint plat · Flat seal · Плоское уплотнение · Z uszczelką płaską

097002-JP	1/2"	8431977207901	20	100	9,3619
097003-JP	3/4"	8431977207925	15	75	13,1272
097004-JP	1"	8431977207949	10	50	22,9253



- JUNTA PLANA BELPA
- FLAT JOINT BELPA - BELPA FLAT SEAL
- ПЛОСКОЕ УПЛОТНЕНИЕ BELPA · USZCZELKA PŁASKA BELPA

79



CODE



€

079233	1/2" (CSA-28 10x19x1,5 mm)				0,3787
079250	3/4" (16x24x1,5 mm)				0,3509
079254	1" (CSA-28 20/30x2 mm)				0,4905
079257	1.1/4" (31/39x2 mm)				0,6907
079258	1.1/2" (35/45x2 mm)				1,2691
079262	2" (40x56,5x2 mm)				2,6935
079264	2.1/4" /CSA-28 45x60x1,5 mm)				2,4368
079261	2.1/2" CSA-28 57x70x2				5,1094



Nuevo · Nouvelle
New · новый · Nowy



- RACOR UNIÓN 2 PIEZAS HH JUNTA PLANA
- RACCORD UNION 2 PIÈCES FF JOINT PLAT · FF 2 PIECES UNION COUPLER FLAT SEAL
- ПЕРЕХОДНИК ВР РАЗЪЕМН. 2Ч. · PÓŁSRUBUNEK GW/GW DO USZCZELKI PŁASKIEJ

83



CODE	↔	Barcode	⊖	□	⊞	€
083204	1/2" x 1"	8431977213667	10		300	5,3172
083305	3/4" x 1.1/4"	8431977209004	5		175	7,9116
083406	1" x 1.1/2"	8431977206928	5		120	8,8660
083507	1.1/4" x 2"	8431977210291	5		75	15,8019
083621	1.1/2" x 2.1/4"					22,9348
083708	2" x 2.1/2"					26,4131
083832	2.1/2" x 3.1/2"					116,4022

- RACOR UNIÓN 2 PIEZAS MH JUNTA PLANA
- RACCORD UNION 2 PIÈCES MF JOINT PLAT · CONE UNION M.I. - F.I. FLAT SEAL
- ПЕРЕХОДНИК - СОЕДИНИТЕЛЬ НР - ВР · PÓŁSRUBUNEK GZ/GW DO USZCZELKI PŁASKIEJ

83MH







CODE	↔	Barcode	⊖	□	⊞	€
083102-MH	M 3/8" x H 1/2"					2,8894
083203-MH	M 1/2" x H 3/4"	8431977207703	10		400	3,3844
083304-MH	M 3/4" x H 1"	8431977208991	10		250	4,9924
083405-MH	M 1" x H 1.1/4"	8431977206119	5		125	7,9016

22

- RACOR DOS PIEZAS PARA MANGUERA
- RACCORD D'ARROSAGE 2 PIÈCES À AILETTE · 2 PART HOSE CONNECTOR
- СОЕДИНИТЕЛЬ ДЛЯ ШЛАНГОВ (РЕЗЬБА ВНУТР. /ШЛАНГ) · ZŁĄCZKA DO WĘŻA NAKRĘTKA



CODE	↔					€
022002	1/2" - 14 mm*				500	2,8592
022010	5/8" - 16 mm					3,3635
022003	3/4" - 20 mm				350	3,7835
022004	1" - 25 mm				250	5,2646
022005	1.1/4" - 30 mm				100	8,4523
022006	1.1/2" - 35 mm				70	12,2318
022007	2" - 50 mm				40	29,5602

· CROMO · Chromé · Chrome · Хромированный · Chrom





022002-C	1/2" - 14 mm*				500	3,8733
022003-C	3/4" - 20 mm				350	4,9727
022004-C	1" - 25 mm				250	6,6986

*DIÁMETRO MANGUERA · Diamètre tuyau · Hose diameter · Диаметр шланга · Średnica węży

30

- ENTRONQUE MACHO PARA MANGUERA
- RACCORD D'ARROSAGE M · HOSE UNION M.I. - HOSE
- СОЕДИНИТЕЛЬ ДЛЯ ШЛАНГОВ (НР /ШЛАНГ) · ZŁĄCZKA DO WĘŻA GZ







CODE	↔					€
030012	1/8" - 9 mm*	8431977203460	25			1,7549
030111	1/4" - 10 mm	8431977200087	25			1,7883
030112	1/4" - 12 mm	8431977203477	25			1,9207
030001	3/8" - 13 mm	8431977200063	25		1000	1,9649
030210	1/2" - 10 mm	8431977204634	25		500	1,9605
030212	1/2" - 12 mm	8431977204641	25		500	1,9591
030214	1/2" - 14 mm	8431977204597	25		500	1,9665
030216	1/2" - 16 mm	8431977204603	25		500	2,3009
030218	1/2" - 18 mm	8431977204733	25		500	2,1684
030220	1/2" - 20 mm	8431977204740	25		500	2,3769
030320	3/4" - 20 mm	8431977200094	10		300	3,0363
030325	3/4" - 22,5 mm	8431977200100	10		250	3,2096
030425	1" - 25 mm	8431977200117	10		200	5,1646
030430	1" - 30 mm	8431977200124	10		150	5,8227
030005	1.1/4" - 35 mm	8431977210130	5		100	9,0654
030006	1.1/2" - 47 mm				50	16,1692
030007	2" - 58 mm				30	23,6600

35

- ENTRONQUE HEMBRA PARA MANGUERA
- RACCORD D'ARROSAGE F · HOSE UNION F.I. - HOSE
- СОЕДИНИТЕЛЬ ДЛЯ ШЛАНГОВ (ВР /ШЛАНГ) · ZŁĄCZKA DO WĘŻA GW



CODE	↔					€
035210	1/2" - 10 mm	8431977209554	25		500	2,1116
035212	1/2" - 12 mm	8431977209561	25		500	2,1437
035214	1/2" - 14 mm	8431977209578	25		500	2,1116
035216	1/2" - 16 mm	8431977209585	25		500	2,1116
035218	1/2" - 18 mm	8431977209592	25		500	2,3141
035220	1/2" - 20 mm	8431977209608	25		500	2,3141
035325	3/4" - 25 mm	8431977209615	10		250	3,3619

23

- RACOR BARCELONA ENCHUFE RÁPIDO
- RACCORD EXPRESS D'ARROSAGE · QUICK RELEASE HOSE CONNECTOR
- ПЕРЕХОДНИК · SZYBKOWŁĄCZKA DO WĘŻA



CODE								
· UNIONES MANGUERA								
· Connexions tuyau · Hose connections · Соединитель для шлангов разъемный (шланг) · Wąż								
023020-M	20 mm (combinable u.rosca 1/2")						450	4,1292
023025-M	25 mm (combinable u.rosca 3/4")						300	6,0844
023030-M	30 mm (combinable u.rosca 1")						160	7,1481
023035-M	35 mm (combinable u.rosca 1.1/4")						100	16,2335
023040-M	40 mm						60	35,8085
023045-M	45 mm (combinable u.rosca 1.1/2")						50	20,9485
023050-M	50 mm						50	45,5932
023060-M	60 mm (combinable u.rosca 2")						30	48,3944



CODE								
· UNIONES ROSCA								
· Connexions vis · M.I. Connections · Соединитель для шлангов разъемный нр · GZ								
023202-M	1/2" (combinable u.manguera 20)						600	3,6634
023303-M	3/4" (combinable u.manguera 25)						400	5,3726
023404-M	1" (combinable u.manguera 30)						250	7,2207
023505-M	1.1/4" (combinable u.manguera 35)						150	11,3847
023606-M	1.1/2" (combinable u.manguera 45)						70	17,5162
023707-M	2" (combinable u.manguera 60)						40	25,2032
· JUNTA · Joint · Rubber joint · Прокладка · Uszczelka gumowa								
023020-G	20 mm							0,8972
023025-G	25 mm							0,7917
023030-G	30 mm							0,8341
023035-G	35 mm							1,1903
023040-G	40 mm							1,2706
023045-G	45 mm							1,7802
023050-G	50 mm							1,7813
023060-G	60 mm							3,3033

- TABLA DE COMBINACIONES · TABLEAU DE COMBINAISON · TABLEAU OF COMBINATIONS
- ТАБЛИЦА КОМБИНАЦИЙ · MOŻLIWE ROZWIĄZANIA

			UNIONES MANGUERA / HOSE CONNECTIONS							
			20	25	30	35	40	45	50	60
			023020-M	023025-M	023030-M	023035-M	023040-M	023045-M	023050-M	023060-M
UNIONES ROSCA TH-READ CONNECTIONS	"1/2"	023202-M	X							
	"3/4"	023303-M		X						
	"1"	023404-M			X					
	"1.1/4"	023505-M				X				
	"1.1/2"	023606-M						X		
	"2"	023707-M								X

70

- LANZA MANGUERA TRES EFECTOS
- MINI LANCE D'ARROSAGE · 3 JET-HOSE SPRAY
- НАКОНЕЧНИК ДЛЯ ШЛАНГОВ (НАСАДКА РАСПЫЛИТЕЛЬ ДЛЯ ВОДЫ) · KOŃCÓWKA DO WĘŻA 3-FUNKCYJNA



CODE								
070016	16 mm							10,9473
070020	20 mm							11,3948

- LANZA GRADUABLE TRES EFECTOS PARA MANGUERA
- LANCE D'ARROSAGE REGABLE 3 JETS · 3 JET-HOSE SPRAY WITH ADJUSTABLE NOZZLE
- НАКОНЕЧНИК ДЛЯ ШЛАНГА С РАСПЫЛИТЕЛЕМ (ТРИ ЭФФЕКТА РЕГУЛИРУЕМЫЙ)
- KOŃCÓWKA DO WĘŻA 3-FUNKCYJNA REGULOWANA

24



CODE	↔	Barcode	⊖	□	⊞	€
· CON RACOR MANGUERA						
· Avec raccord tuyau · With hose fitting · Со шланговым штуцером · Ze złączką do węża						
024016	16 mm					36,6699
024020	20 mm					38,2999
024025	25 mm					36,1727



· CON ENCHUFE RÁPIDO MODELO "GARDEN"						
· Avec raccord express · With quick release · Быстроразъемный · Z szybkozłączką						
024100						39,0756

- PITONES RIEGO PARA MANGUERA
- BEC D'ARROSAGE POUR TUYAU SOUPLE · HOSE SPRAY JET NOZZLE
- НАСАДКА ДЛЯ ШЛАНГА · KOŃCÓWKA DO WĘŻA

25

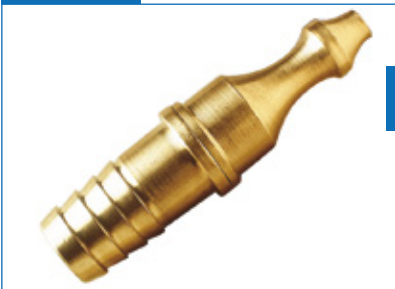

CODE	↔	Barcode	⊖	□	⊞	€
025016	16 mm*	8431977207727	10			9,9809
025020	20 mm	8431977206836	10			8,3318
025025	25 mm	8431977207956	10			13,6769
025030	29 mm	8431977213179	5			19,3096
025035	35 mm					49,7098

*Diámetro manguera · Diamètre tuyau · Hose diameter · Диаметр шланга · Średnica węża

- EMPALME UNIÓN PARA MANGUERA
- RACCORD UNION D'ARROSAGE · STRAIGHT HOSE CONNECTOR
- СОЕДИНИТЕЛЬ ДЛЯ ШЛАНГОВ · ZŁĄCZKA DO WĘŻA

29



CODE	↔	Barcode	⊖	□	⊞	€
029001	3/8" - 13 mm*	8431977205600	10		700	3,2584
029002	1/2" - 16 mm	8431977205617	10		400	4,6080
029003	3/4" - 21 mm	8431977205624	10		300	6,2061
029004	1" - 25 mm	8431977209219	10		150	10,6302
029005	1.1/4" - 31 mm				75	15,6562
029006	1.1/2" - 47 mm				40	27,1261
029007	2" - 57 mm				25	37,3927

*Diámetro manguera · Diamètre tuyau · Hose diameter · Диаметр шланга · Średnica węża

- TE EMPALME MANGUERA
- TE UNION D'ARROSAGE · HOSE TEE CONNECTOR
- ТРОЙНИК СОЕДИНИТЕЛЬ ДЛЯ ШЛАНГОВ · TRÓJNIK DO WĘŻA

28



CODE	↔	Barcode	⊖	□	⊞	€
028001	3/8" - 13 mm*	8431977205594	10			3,8044
028002	1/2" - 17 mm	8431977202562	10		300	5,8512
028003	3/4" - 21 mm	8431977202579	10		200	7,2905
028004	1" - 25 mm	8431977209196	5		100	15,6963
028005	1.1/4" - 31 mm				50	22,7701

*Diámetro manguera · Diamètre tuyau · Hose diameter · Диаметр шланга · Średnica węża

27

- COLZADA PARA GRIFO BOCA RIEGO TIPO MADRID
- RACCORD POUR ROBINET D'ARROSAGE TYPE MADRID · FITTING FOR MADRID TYPE HOSE TAP
- СОЕДИНИТЕЛИ ДЛЯ ШЛАНГОВ · ZŁĄCZKA DO WĘŻA - TYP MADRID



CODE	↔	▮▮▮▮	○	□	田	€
· RECTA CON OREJA						
· Droit avec ergot · Straight with lug · Прямой (с ушками) · Prosta z uchwytem						
027100						83,3608



· CURVA CON OREJA						
· Cintré avec ergot · Curved with lug · Изогнутый (с ушками) · Zagięta z uchwytem						
027200						97,1132
· BASE MACHO · Base mâle · Base male · Основание с внешней резьбой · Podstawa GZ						
027300						23,0174
· TUERCA OREJAS · Ecrou ergot · Nut lug · Гайка ушки · Nakrętka						
027400						55,7942
· JUNTA · Joint · Rubber joint · Прокладка · Uszczelka gumowa						
027000-G						0,8514

74

· COLLARÍN
· COLLIER · COLLAR · ВОДОУВВОД / ХОМУТ · OBEJMA



CODE



· CON TOMA

· Avec prise d'eau · Draw-off collar with seal · С отверстием · Obejma do trójnikowania z uszczelką

074202	20 x 1/2"	8431977201213	10	200	7,6502
074252	25 x 1/2"	8431977201220	10	150	8,0634
074322	32 x 1/2"	8431977207826	5	100	10,3226
074323	32 x 3/4"	8431977210413	5	80	10,9243
074402	40 x 1/2"			60	16,2458
074403	40 x 3/4"			65	15,4497
074502	50 x 1/2"			55	15,7340
074503	50 x 3/4"			50	15,5859
074504	50 x 1"			50	15,9684
074542	54 x 1/2"				18,7352
074632	63 x 1/2"			35	26,2944
074633	63 x 3/4"			35	25,7389
074634	63 x 1"			35	25,8866
074753	75 x 3/4"			25	49,0925
074754	75 x 1"			25	44,8485
074902	90 x 1/2"			20	67,9674
074903	90 x 3/4"			20	61,5415
074904	90 x 1"			16	60,3488



· CIEGO · Aveuble · Tube repair collar with seal · Хомут · Zestaw naprawczy z uszczelką

074020	20	8431977214596	10	200	6,4808
074025	25	8431977214626	10	200	7,2592
074032	32			100	10,4084
074040	40				13,9204
074050	50			65	17,4988
074054	54				19,6469
074063	63			35	22,1360
074075	75				33,9979
074090	90				56,4328



· CON TOMA Y DOBLE FIJACIÓN

· Avec prise d'eau et double fixations · Draw-off collar with seal and double fixing

· С отверстием и двойной фиксацией · Obejma do trójnikowania z uszczelką i podwójnym mocowaniem

0741212	21 x 1/2"	8431977214794	15	75	8,8349
---------	-----------	---------------	----	----	--------

86

· COLECTOR HH
· COLLECTEUR FF · MANIFOLD FF · КОЛЛЕКТОР ВР - ВР · ROZDZIELACZ GW/GW



CODE



€

· 50 mm ENTRE CENTROS SALIDA HEMBRA
· 50 mm entre centres sortie femelle · 50 mm between centres female outlet
· Расстояние между центрами ВР 50мм · Rozstaw osi wylotów 1/2" GW - 50 mm

0865023	HH 3/4" - 2 SALIDAS H1/2"			60	19,6316
0865033	HH 3/4" - 3 SALIDAS H1/2"			50	26,2062
0865043	HH 3/4" - 4 SALIDAS H1/2"			40	34,2309
0865053	HH 3/4" - 5 SALIDAS H1/2"			25	42,2217
0865063	HH 3/4" - 6 SALIDAS H1/2"			20	51,4850
0865073	HH 3/4" - 7 SALIDAS H1/2"				59,8417
0865083	HH 3/4" - 8 SALIDAS H1/2"				68,3331
0865093	HH 3/4" - 9 SALIDAS H1/2"				76,8869
0865103	HH 3/4" - 10 SALIDAS H1/2"				85,1792
0865113	HH 3/4" - 11 SALIDAS H1/2"				94,0832
0865123	HH 3/4" - 12 SALIDAS H1/2"				105,5891
0865024	HH 1" - 2 SALIDAS H1/2"			50	20,5440
0865034	HH 1" - 3 SALIDAS H1/2"			40	29,3389
0865044	HH 1" - 4 SALIDAS H1/2"			30	38,7108
0865054	HH 1" - 5 SALIDAS H1/2"			25	49,0436
0865064	HH 1" - 6 SALIDAS H1/2"			12	62,5565
0865074	HH 1" - 7 SALIDAS H1/2"				73,8986
0865084	HH 1" - 8 SALIDAS H1/2"				82,4309
0865094	HH 1" - 9 SALIDAS H1/2"				94,5500
0865104	HH 1" - 10 SALIDAS H1/2"				102,9863
0865114	HH 1" - 11 SALIDAS H1/2"				112,9592
0865124	HH 1" - 12 SALIDAS H1/2"				122,0087

861

· TE PARA TERMINAL COLECTOR
· TE POUR TERMINAL COLLECTEUR · TEE FOR END MANIFOLD
· ТРОЙНИК ДЛЯ ВЫХОДА КОЛЛЕКТОРА · TRÓJNIK DO ROZDZIELACZA



CODE



€

0861231	1/2" x 3/4" x 3/8"	8431977209622	5	40	7,1814
0861241	1/2" x 1" x 3/8"	8431977209639	5	60	8,2152

87

· COLECTOR MH
· COLLECTEUR MF · MANIFOLD MF · КОЛЛЕКТОРЫ HP - BP · ROZDZIELACZ GW/GZ



CODE



· 55 mm ENTRE CENTROS SALIDA MACHO
· 55 mm entre centres sortie mâle · 55 mm between centres male outlet
· Расстояние между центрами нр 55мм · Rozstaw osi wylotów GZ - 55 mm

0875524	1" - 2 SALIDAS M3/4"					23,3684
0875534	1" - 3 SALIDAS M3/4"					33,2949



· 55 mm ENTRE CENTROS SALIDA HEMBRA
· 55 mm entre centres sortie femelle · 55 mm between centres female outlet
· Расстояние между центрами BP 55мм · Rozstaw osi wylotów GW - 55 mm

0875033-H	3/4" - 3 SALIDAS H1/2"					31,5116
-----------	------------------------	--	--	--	--	---------



· 50 mm ENTRE CENTROS SALIDA MACHO
· 50 mm entre centres sortie mâle · 50 mm between centres male outlet
· Расстояние между центрами нр 50мм · Rozstaw osi wylotów 1/2" GZ - 50 mm

0875032	1/2" - 3 SALIDAS M1/2"					17,5249
0875023	3/4" - 2 SALIDAS M1/2"			60		15,6772
0875033	3/4" - 3 SALIDAS M1/2"			40		22,8857
0875043	3/4" - 4 SALIDAS M1/2"			40		30,9461
0875053	3/4" - 5 SALIDAS M1/2"			30		37,7895
0875024	1" - 2 SALIDAS M1/2"			50		18,0066
0875034	1" - 3 SALIDAS M1/2"			40		27,2270
0875044	1" - 4 SALIDAS M1/2"			30		36,4689
0875054	1" - 5 SALIDAS M1/2"					43,3237



· 35 mm ENTRE CENTROS SALIDA MACHO
· 35 mm entre centres sortie mâle · 35 mm between centres male outlet
· Расстояние между центрами нр 35мм · Rozstaw osi wylotów 1/2" GZ - 35 mm

087023	3/4" x 2 SALIDAS M1/2"			100		9,8099
087033	3/4" x 3 SALIDAS M1/2"			60		14,6138
087043	3/4" x 4 SALIDAS M1/2"			50		21,9592
087053	3/4" x 5 SALIDAS M1/2"			40		27,8871
087024	1" x 2 SALIDAS M1/2"			60		14,5230
087034	1" x 3 SALIDAS M1/2"			40		19,1233
087044	1" x 4 SALIDAS M1/2"			30		28,6518
087054	1" x 5 SALIDAS M1/2"			30		34,7455



96

· TE CINCO VÍAS
· TÉ À CINQ VOIES · FIVE-WAY TEE · КРЕСТОВИНА С КРАНОМ МАЕВСКОГО · ZŁĄCZKA 5-DROGOWA



CODE	↔	Barcode	⊖	□	⊞	€
096834	1" x 1" x 1" - 83 mm				80	15,2914
096833	1" x 1" x 3/4" - 83 mm				80	15,1780
096924	1" x 1" x 1" - 92 mm				70	17,8264
096923	1" x 1" x 3/4" - 92 mm				70	18,7953
096124	1" x 1" x 1" - 120 mm				60	20,3273
096123	1" x 1" x 3/4" - 120 mm				60	21,9706

52

· VÁLVULA DE PIE
· CLAPET DE RETENUE FF · FOOT VALVE · ОБРАТНЫЙ КЛАПАН · ZAWÓR KŁAPOWY



CODE	↔	Barcode	⊖	□	⊞	€
· COMPLETA · Complete · Whole valve · В сборе · Z koszem ssawnym ze stali nierdzewnej						
052001	3/8"					17,8069
052002	1/2"	8431977210376		25		9,4648
052003	3/4"	8431977210369		12		12,3796
052004	1"	8431977210383		10		15,4838
052005	1.1/4"					32,5524
052006	1.1/2"					45,7421
052007	2"					67,7119
052008	2.1/2"					145,9812
052009	3"					214,2382
052040	4"					329,7044



· FILTRO INOXIDABLE · Filtre inox · Stainless steel filter
· Фильтр для обратного клапана · Kosz ssawny ze stali nierdzewnej

052001-INOX	3/8"					1,8718
052002-INOX	1/2"					1,9329
052003-INOX	3/4"					2,1931
052004-INOX	1"			100		2,6338
052005-INOX	1.1/4"					3,2108
052006-INOX	1.1/2"					4,6594
052007-INOX	2"					5,6114
052008-INOX	2.1/2"					10,0855
052009-INOX	3"					12,3780
052040-INOX	4"					18,0379

53

· VÁLVULA DE RETENCIÓN HH
· CLAPET DE RETENUE FF · F.I. x F.I. NON-RETURN VALVE
· ОБРАТНЫЙ КЛАПАН ВР-ВР · ZAWÓR ZWROTNY GW/GW



CODE	↔	Barcode	⊖	□	⊞	€
053001	3/8"					15,9352
053002	1/2"	8431977214053		14	140	7,5319
053003	3/4"	8431977214060		12	120	10,1867
053004	1"	8431977214121		10	90	12,8500
053005	1.1/4"	8431977214039		8	48	29,3416
053006	1.1/2"	8431977214046		6	36	41,0827
053007	2"	8431977214077		4	24	62,1006
053008	2.1/2"				8	135,8958
053009	3"				4	201,8602
053040	4"				4	311,6665

53MH

- VÁLVULA DE RETENCIÓN MH
- CLAPET DE RETENUE MF · M.I. x F.I. NON-RETURN VALVE
- ОБРАТНЫЙ КЛАПАН НР-ВР · ZAWÓR ZWROTNY GZ/GW



CODE	↔	Barcode	⊗	□	⊞	€
053004-MH	1"	8431977214800		8		10,5967

54

- VÁLVULA DE RETENCIÓN MM
- CLAPET DE RETENUE MM · M.I. x M.I. NON-RETURN VALVE
- ОБРАТНЫЙ КЛАПАН НН · ZAWÓR ZWROTNY GZ/GZ



CODE	↔	Barcode	⊗	□	⊞	€
054002	1/2"	8431977205976		20	400	5,8651
054003	3/4"	8431977205983		12	240	7,0437
054004	1"	8431977205990		8	160	9,2116

VÁLVULA DE 1"

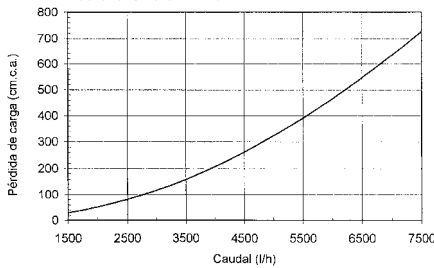

VÁLVULA DE 3/4"

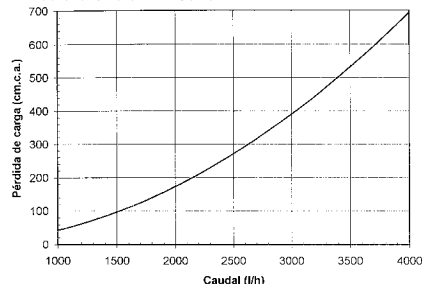

VÁLVULA DE 1/2"

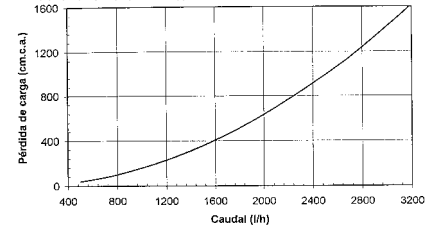

104

- VÁLVULA DE RETENCIÓN HH DOS SALIDAS
- CLAPET DE RETENUE HH 2 SORTIES · F.I. x F.I. NON-RETURN VALVE 2 OUTLETS
- ОБРАТНЫЙ КЛАПАН ДВА ВЫХОДА · ZAWÓR ZWROTNY GW/GW, 2 WYJŚCIA



CODE	↔	Barcode	⊗	□	⊞	€
104022	1/2"	8431977209837		20	160	11,5444
104023	3/4"	8431977209820		25	125	12,8855
104024	1"	8431977209851		15	75	24,1878
104025	1.1/4"	8431977209868		10	50	32,7531

56

- VÁLVULA ANTIRRETORNO MH
- CLAPET DE RETENUE MF · M.I.xF.I. NON-RETURN VALVE
- ОБРАТНЫЙ КЛАПАН НР - ВР · ZAWÓR ZWROTNY GW/GZ







CODE	↔	Barcode	⊗	□	⊞	€
056002	1/2"	8431977214633		40		5,0799

VÁLVULA ANTIRRETORNO PARA BATERÍA BAÑO Y BATERÍA PLATO DUCHA
EVITA EL GOTEYO Y EL RETORNO DE AGUA AL CUERPO DEL GRIFO
MEJORA LA LIMPIEZA Y LA HIGIENE.

- VÁLVULA ESFERA PASO TOTAL
- VANNE À BOISSEAU PASSAGE TOTAL · BALL-VALVE FULL BORE
- КРАН ШАРОВОЙ ПОЛНОПРОХОДНЫЙ · ZAWÓR KULOWY GW

88







CODE	↔					€
088011	1/4"					9,8482
088001	3/8"	8431977213957	30	150		7,0863
088002	1/2"	8431977213964	20	100		7,7350
088003	3/4"	8431977213971	15	60		11,1090
088004	1"	8431977213988	10	50		17,8991
088005	1.1/4"	8431977213995	5	20		24,1280
088006	1.1/2"	8431977214008	4	12		41,8661
088007	2"	8431977214015	2	10		59,0894
088008	2.1/2"				7	134,0365
088009	3"					213,6762
088040	4"					359,3192

- VÁLVULA DE RETENCIÓN CLAPETA CAUCHO
- CLAPET DE RETENUE AVEC JOINT EN CAOUTCHOUC · NON-RETURN VALVE WITH RUBBER SEAL
- КЛАПАН ОБРАТНЫЙ ГОРИЗОНТАЛЬНЫЙ С РЕЗИНОВЫМ УПЛОТНЕНИЕМ
- ZAWÓR ZWROTNY KLAPOWY Z GUMOWĄ USZCZELKĄ

102







CODE	↔					€
102002	1/2" - PN 12	8431977213452	25			16,4067
102003	3/4" - PN 12	8431977213469	12			22,3406
102004	1" - PN 12	8431977213476	10			32,0221
102005	1.1/4" - PN 10	8431977213483	6			42,1975
102006	1.1/2" - PN 10	8431977213490	2			64,4790
102007	2" - PN 10					88,7686
102008	2.1/2" - PN 8					124,6357
102009	3" - PN 8					213,3867
102040	4" - PN 8					376,4472

- VÁLVULA DE FONDO FILTRO LATÓN
- CLAPET DE RETENUE FILTRE LAITON · FOOT VALVE BRASS FILTER
- ФИЛЬТР ЛАТУННЫЙ СЕТЧАТЫЙ · ZAWÓR ZWROTNY Z KOSZEM SSAWNYM

103



CODE	↔					€
103003	3/4" - PN 10	8431977213513	20			24,3194
103004	1" - PN 10	8431977213520	15			29,0995
103005	1.1/4" - PN 8	8431977213537	15			43,1859
103006	1.1/2" - PN 8	8431977213544	10			55,6996
103007	2" - PN 8	8431977213551	5			86,9919
103008	2.1/2" - PN 6					133,4667
103009	3" - PN 6					173,5873
103040	4" - PN 6					320,4490

* CUERPO LATÓN: ESTAMPADO UNE-EN 12165 CW617N / FUNDIDO EN-1982 CB753S
JUNTA: NBR 90 °C TEMPERATURA MÁXIMA - DUREZA 65 SH
ROSCA GAS ISO 228/1 (DIN 259)

Brass body: stamped UNE-EN 12165 CW617N / cast EN -1982 CB753S
Joint: NBR 90 °C maximum temperature - strength 65 SH
gas thread ISO 228/1 (DIN 259)



- FILTRO LATÓN TIPO Y CON TAMIZ INOX
- FILTRE LAITON Y AVEC CRIBLE EN ACIER INOX · BRASS FILTER Y WITH STAINLESS STEEL SIEVE
- ФИЛЬТР "Y" - ОБРАЗНЫЙ СЕТЧАТЫЙ · FILTR KAŹOWY "Y"

101



CODE	↔	Barcode	⊙	□	⊞	€
101002	1/2" - PN 16	8431977213391		25		8,8487
101003	3/4" - PN 16	8431977213407		12		13,5126
101004	1" - PN 16	8431977213414		10		19,9119
101005	1.1/4" - PN 16	8431977213421		6		40,2315
101006	1.1/2" - PN 16	8431977213438		2		53,3103
101007	2" - PN 16					88,3043
101008	2.1/2" - PN 16					160,9977
101009	3" - PN 16					223,0623
101040	4" - PN 16					422,1026

CUERPO LATÓN: ESTAMPADO UNE-EN 12165 CW617N / FUNDIDO EN-1982 CB753S

TAMIZ: INOX AISI 316 / LUZ 300 MICRAS

JUNTA: PTFE 140 °C TEMPERATURA MÁXIMA

ROSCA GAS ISO 228/1 (DIN 259)

Brass body: stamped UNE-EN 12165 CW617N / cast EN-1982 CB753S

Filter: stainless steel AISI 316 / light 300 microns

Joint: PTFE 140 °C maximum temperature

gas thread ISO 228/1 (DIN 259)

VÁLVULA RETENCIÓN PANEL SOLAR

105

- CLAPET DE RETENUE POUR PANNEAU SOLAIRE · NON-RETURN VALVE FOR SOLAR PANEL
- ОБРАТНЫЙ КЛАПАН ДЛЯ СОЛНЕЧНОЙ ПАНЕЛИ · ZAWÓR ZWROTNY DO PANELU SŁONECZNEGO



CODE	↔	Barcode	⊙	□	⊞	€
105003	3/4"	8431977215562		12	144	17,7791



Nuevo · Nouvelle
New · новый · Nowy



41

· BEBEDERO TOLVA PARA CERDOS
· BUVETTE POUR COCHONS · DRINKER FOR PIGS · ПОИЛКИ ДЛЯ ПОРОСЯТ · POIDEŁKO DLA ŚWIŃ



CODE	↔	Barcode	⊗	□	⊞	€
· ROSCA INTERIOR · Vis intérieur · Inner thread · Внутренняя резьба · Gwint wewnętrzny						
041001	3/8"	8431977200391	25			4,9568



· ROSCA EXTERIOR · Vis extérieur · External thread · Наружная резьба · Gwint zewnętrzny						
041002	1/2"	8431977203330	25			4,5290

42

· BEBEDERO AUTOMÁTICO PARA CERDOS
· BUVETTE AUTOMATIC POUR COCHONS · AUTOMATIC DRINKER FOR PIGS
· ПОИЛКИ АВТОМАТИЧЕСКИЕ ДЛЯ ПОРОСЯТ · AUTOMATYCZNE POIDEŁKO DLA ŚWIŃ



CODE	↔	Barcode	⊗	□	⊞	€
· CUERPO DE LATÓN Y PITORRO INOX · Corps en laiton et tige inox · Body of brass and spout of stainless steel · Корпус из латуни носик из нерж. Стали · Korpus mosiężny, końcówka ze stali nierdzewnej						
042000-M	1/2"	8431977200414	25	250		4,1784

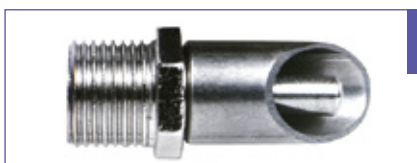

· CUERPO Y PITORRO INOX · Corps et tige en inox · Body and spout of stainless steel · Корпус и носик из нерж. Стали · Korpus i końcówka ze stali nierdzewnej						
042000-N	1/2"	8431977200421	25	250		7,9334

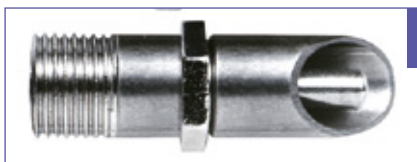

· CUERPO Y PITORRO LARGO INOX. · Corps et tige long en inox · Long body and spout of stainless steel · Корпус и носик удлинённые из нерж. Стали · Wydłużony korpus i końcówka ze stalinierdzewnej						
042000-NL	1/2"	8431977203309	25	250		8,3712



· MUELLE · Ressort · Spring · Пружина · Sprężyna						
042100						0,5831



· JUNTA TÓRICA · Joint de caoutchouc · O'ring gasket · Прокладка · Uszczelka typu o'ring						
042200						0,2257

43

· BEBEDERO AUTOMÁTICO PARA CERDAS DE CRÍA
· ABREUVOIR AUTOMATIQUE POUR TRUIES D'ELEVAGE · AUTOMATIC DRINKER FOR BREEDING SOWS
· ПОИЛКА ДЛЯ СУПОРОСНЫХ СВИНЕЙ · AUTOMATYCZNE POIDEŁKO DLA MACIOR



CODE	↔	Barcode	⊗	□	⊞	€
043000	1/2"	8431977200438	25	250		5,3741
· MUELLE · Ressort · Spring · Пружина · Sprężyna						
043100						0,7182

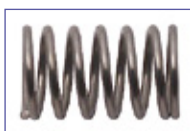

· JUNTA TÓRICA · Joint de caoutchouc · O'ring gasket · Прокладка · Uszczelka typu o'ring						
043200						0,8108



- GRIFO BOCA RIEGO VERTICAL
- BOUCHE D'ARROSAGE VERTICAL · UPRIGHT HOSE TAP
- ВЕНТИЛЬ ВОДРАЗБОРНЫЙ УГЛОВОЙ С НАСАДКОЙ ДЛЯ ШЛАНГА ИЛИ ПЕРЕХОДНИКОМ
- ZAWÓR PIONOWY DO WĘŻA

1



CODE



€

· CON RACOR BARCELONA

· Avec raccord express · With quick release connector

· С быстроразъемным переходником · Z szybkozłączką do węża

001002-B	1/2"				50	30,4625
001003-B	3/4"				30	42,0083
001004-B	1"				15	61,1919
001006-B	1.1/2"				4	203,0582

· CON RACOR MANGUERA

· Avec raccord tuyau · With hose fitting · Со шланговым штуцером · Ze złączką do węża

001002-R	1/2"				50	25,1572
001003-R	3/4"				30	33,2509
001004-R	1"				15	51,7200
001006-R	1.1/2"				6	173,2898

- GRIFO BOCA RIEGO HORIZONTAL
- BOUCHE D'ARROSAGE HORIZONTAL · HORIZONTAL HOSE TAP
- ВЕНТИЛЬ ВОДРАЗБОРНЫЙ УГЛОВОЙ С НАСАДКОЙ ДЛЯ ШЛАНГА ИЛИ ПЕРЕХОДНИКОМ
- ZAWÓR POZIOMY DO WĘŻA

2



CODE



€

· CON RACOR BARCELONA

· Avec raccord express · With quick release connector

· С быстроразъемным переходником · Z szybkozłączką do węża

002002-B	1/2"				50	30,3367
002003-B	3/4"				30	46,5422
002004-B	1"				15	63,0325
002006-B	1.1/2"				4	223,7705

· CON RACOR MANGUERA

· Avec raccord tuyau · With hose fitting · Со шланговым штуцером · Ze złączką do węża

002002-R	1/2"				50	24,5941
002003-R	3/4"				30	37,0945
002004-R	1"				15	53,3684
002006-R	1.1/2"				4	203,0593

- GRIFO PASO ROSCA CON MONTURA 1/2"
- ROBINET D'ARRET AVEC TÊTE ROBINET PUISAGE 1/2" · SCREWDOWN STOPCOCK WITH 1/2" HEADWORK
- НАЖИМАЮЩЕЙ ЗАПОРНЫЙ КРАН С ВЕНТИЛЬНАЯ ГОЛОВКА 1/2"
- ZAWÓR GRZYBKOWY Z GŁOWICĄ ZAWORU 1/2"

3



CODE



€

003022	1/2"	8431977214756		25	125	12,5580
003023	3/4"	8431977214763		20	100	16,0355



Nuevo · Nouvelle
New · новый · Nowy



89

· GRIFO BARRIL MINI

· MINI-ROBINET POUR TONNEAU · MINI-TAP FOR BARREL · КРАН ДЛЯ ЁМКОСТИ МИНИ · KRAN MINI DO BECZEK

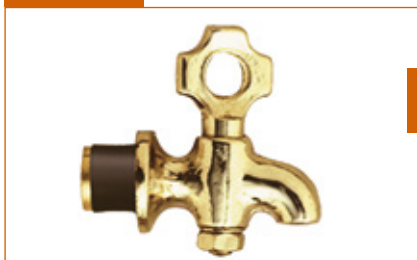

CODE



· ANCLAJE TACO CAUCHO

· Ancrage cheville en caoutchouc · Rubber stopper fastening

· Соединение из каучука · Połączenie z uszczelnieniem gumowym

089000-G	1 a 2 litros			400	14,5020
----------	--------------	--	--	-----	---------



· ANCLAJE ROSCA 7/16"

· Ancrage filet de 7/16" · 7/16" threaded fastening

· Соединение резьбовое 7/16" · Połączenie gwintowane 7/16"

089716	1 a 2 litros			400	13,1382
--------	--------------	--	--	-----	---------

90

· GRIFO PARA BARRIL

· ROBINET POUR TONNEAU · TAP FOR BARREL · КРАН ДЛЯ ЁМКОСТИ · KRAN DO BECZEK



CODE



· ANCLAJE ROSCA 7/16"

· Ancrage filet de 7/16" · 7/16" threaded fastening

· Соединение резьбовое 7/16" · Połączenie gwintowane 7/16"

090716	5 a 10 litros			200	17,4286
--------	---------------	--	--	-----	---------

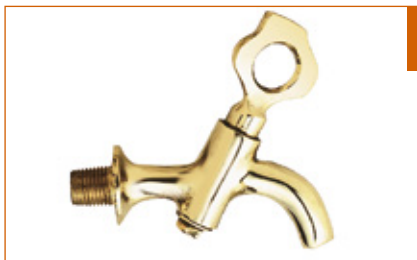

· ANCLAJE ROSCA CÓNICA 1/4"

· Ancrage filet de 1/4" conique · 1/4" conical threaded fastening

· Резьба кон. 1/4" · Połączenie gwintowane stożkowe 1/4"

090011	16 litros			125	27,5058
--------	-----------	--	--	-----	---------



6

· GRIFO CODO PRESIÓN
· ROBINET PUISAGE · BIBCOCK · КРАНИК · ZAWÓR CZERPALNY



CODE	↔	Barcode	⊗	□	⊞	€
006002	1/2"	8431977214183		12	60	18,8663
006003	3/4"	8431977214749		8	40	31,3138

· CROMO · Chromé · Chrome · Хромированный · Chrom

006002-C	1/2"	8431977709733		12	60	23,3121
006003-C	3/4"	8431977712443		8	32	36,5349

· ECONÓMICO · Economique · Light pattern · Эконом. · Wersja ekonomiczna

006002-E	1/2"	8431977210437		15	75	13,1255
006003-E	3/4"	8431977210444		12	60	19,3974

· CROMO ECONÓMICO · Chrome économique · Chrome light pattern

· Хромированный и эконом. · Chrom - wersja ekonomiczna

006002-CE	1/2"	8431977710289		15	75	15,5257
006003-CE	3/4"	8431977712450		12	60	25,0567

7

· GRIFO CODO PRESIÓN CON RACOR MANGUERA
· ROBINET PUISAGE AVEC RACCORD D'ARROSAGE · BIBCOCK WITH HOSE CONNECTOR
· КРАНИК С НАСАДКОЙ ДЛЯ ШЛАНГА · ZAWÓR CZERPALNY ZE ZŁĄCZKĄ DO WĘŻA



CODE	↔	Barcode	⊗	□	⊞	€
007002	1/2"	8431977712504		10	50	25,7113
007003	3/4"	8431977712542		4	20	36,9848
007004	1"				20	60,4182

· CROMO · Chromé · Chrome · Хромированный · Chrom

007002-C	1/2"	8431977712511		10	50	32,6532
007003-C	3/4"	8431977712573		4	20	43,3977

· ECONÓMICO · Economique · Light pattern · Эконом. · Wersja ekonomiczna

007002-E	1/2"	8431977212615		10	50	18,9203
007003-E	3/4"	8431977212783		8	40	26,5048

· CROMO ECONÓMICO · Chrome économique · Chrome light pattern

· Хромированный и эконом. · Chrom - wersja ekonomiczna

007002-CE	1/2"	8431977712528		10	50	23,7757
007003-CE	3/4"	8431977712658		8	40	32,1945

71

· GRIFO ESFERA CODO MANGUERA
· ROBINET CODE À BOISSEAU AVEC RACCORD D'ARROSAGE · BALL VALVE BIBCOCK WITH HOSE CONNECTOR
· КРАН ШАРОВОЙ С НОСИКОМ В ФОРМЕ НАСАДКИ ДЛЯ ШЛАНГА
· ZAWÓR CZERPALNY KULOWY ZE ZŁĄCZKĄ DO WĘŻA



CODE	↔	Barcode	⊗	□	⊞	€
071002	1/2"	8431977213568		10	50	10,0717
071003	3/4"	8431977214022		8	40	13,6770



12

· GRIFO FUENTE PÚBLICA
· ROBINET FONTAINE PUBLIQUE · DRINKING FOUNTAIN · КРАН С КЛАПАНОМ · ZAWÓR DO UJĘĆ PUBLICZNYCH



CODE



€

· CAÑO LARGO PULIDO

· Вес long poli · Long spout polished · Носик длинный полированный · Długa końcówka, błyszcząca

012102	1/2"	8431977712726		6	30	48,7945
01210299	Kit recambio 1/2"					20,7265

· CAÑO LARGO CROMO

· Вес long chromé · Long spout chrome

· Носик длинный хромированный · Długa końcówka, chromowany

012102-C	1/2"	8431977712733		6	30	64,1301
----------	------	---------------	--	---	----	---------



· CAÑO CORTO PULIDO

· Вес court poli · Short spout polished

· Носик короткий полированный · Krótka końcówka, błyszcząca

012203	3/4"	8431977712757		6	30	56,7750
012204	1"	8431977701379		6	30	56,6831
01220399	Kit recambio 3/4" - 1"					17,9616

· CAÑO CORTO CROMO

· Вес court chromé · Short spout chrome

· Носик короткий хромированный · Krótka końcówka, chromowany

012203-C	3/4"	8431977712771		6	30	74,6187
012204-C	1"	8431977701386		6		74,4979



· BARCELONA PULIDO

· Barcelona poli · Barcelona polished

· С клапаном барселона полиров. · Zawór ujęć publicznych Barcelona - błyszcząca

012304	1"	8431977712856		4	20	110,9338
01230499	Kit recambio 1"					29,4166

· BARCELONA CROMO

· Barcelona chromé · Barcelona chrome

· С клапаном барселона хром. · Zawór ujęć publicznych Barcelona chrom

012304-C	1"	8431977712863		4	20	145,7988
----------	----	---------------	--	---	----	----------



· CANALETAS PULIDO

· Canaletas poli · Canaletas polished

· С клапаном Каналетас полиров. · Zawór ujęć publicznych Canaletas - błyszcząca

012404	1"					445,9132
--------	----	--	--	--	--	----------

40

· FUENTE SURTIDOR
· FONTAINE SORTIE CONTINUE · CONTINUOUS RUNNING FOUNTAIN · ФОНТАНЧИК · FONTANNA



CODE



€

040000						35,3959
--------	--	--	--	--	--	---------



· GRIFO LAVADORA DOBLE

45

· ROBINET MACHINE À LAVER DOUBLE · WASHING MACHINE TAP TWO OUTLETS

· КРАН ДЛЯ ПОДКЛЮЧЕНИЯ СТИРАЛЬНОЙ МАШИНЫ (ДВОЙНОЙ) · KRAN Z ZAWOREM DO PRALKI



CODE	↔	Barcode	⊙	□	⊞	€
· VOLANTE METAL · Volant métal · Metal handle · Ручка металлическая · Metalowa ręczka						
045000-VM	1/2" - 3/4"			5	30	52,2599
· VOLANTE ABS CROMADO						
· Voltant ABS chromé · Chrome-plated ABS handle						
· Ручка из хромированного пластика · Plastikowa ręczka chromowana						
045000-VPC	1/2" - 3/4"	8431977208748		5	30	41,2451

· GRIFO LAVADORA SIMPLE

46

· ROBINET MACHINE À LAVER SIMPLE · WASHING MACHINE TAP ONE OUTLET

· КРАН ДЛЯ ПОДКЛЮЧЕНИЯ СТИРАЛЬНОЙ МАШИНЫ · ZAWÓR PRALKOWY



CODE	↔	Barcode	⊙	□	⊞	€
· VOLANTE METAL · Volant métal · Metal handle · Ручка металлическая · Metalowa ręczka						
046000-VM	1/2" - 3/4"	8431977208663		10		25,5371
· VOLANTE ABS CROMADO						
· Voltant ABS chromé · Chrome-plated ABS handle						
· Ручка из хромированного пластика · Plastikowa ręczka chromowana						
046000-VPC	1/2" - 3/4"	8431977208670		10		20,2301



· VOLANTE ECONÓMICO ABS CROMADO						
· Voltant économique ABS chromé · Light pattern chrome-plated ABS handle						
· Ручка из хром.Пластика эконом.						
· Wersja ekonomiczna - zawór pralkowy, plastikowa ręczka, chromowana						
046000-EVPC	1/2" - 3/4"					13,4168

· GRIFO LAVABO MODELO HOGAR

50

· ROBINET DE LAVABO MODELE HOGAR · WASHBASIN TAP MODEL HOGAR

· КРАН ДЛЯ УМЫВАЛЬНИКА · KRAN UMYWALKOWY TYPU "HOGAR"



CODE	↔	Barcode	⊙	□	⊞	€
· VOLANTE METAL · Volant métal · Metal handle · Ручка металлическая · Metalowa ręczka						
050000-VM		8431977209042		6		40,6106
· VOLANTE ABS CROMADO						
· Voltant ABS chromé · Chrome-plated ABS handle						
· Ручка из хромированного пластика · Plastikowa ręczka chromowana						
050000-VPC		8431977215937		6		35,6870



51

· GRIFO FREGADERA
· ROBINET LAVOIR · SINK TAP · КРАН ПОД ОДНУ ВОДУ ДЛЯ КУХНИ · KRAN ZLEWOZMYWAKOWY

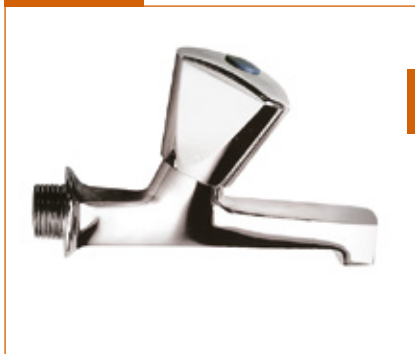

CODE €

· VOLANTE METAL · Volant métal · Metal handle · Ручка металлическая · Metalowa ręczka						
051012-VM	1/2" caño 12cm	8431977208588		6		37,8564
051017-VM	1/2" caño 17 cm	8431977208595		6		42,0905

· VOLANTE ABS CROMADO

· Voltant ABS chromé · Chrome-plated ABS handle

· Ручка из хромированного пластика · Plastikowa ręczka chromowana

051012-VPC	1/2" caño 12 cm	8431977208601		6		31,8769
051017-VPC	1/2" caño 17 cm	8431977208618		6		36,0290

55

· GRIFO FREGADERA MODELO RIO
· ROBINET LAVOIR MODELE RIO · SINK TAP MODEL RIO
· ВОДРАЗБОРНЫЙ КРАН МОДЕЛЬ RIO · KRAN ZLEWOZMYWAKOWY TYPU "RIO"



CODE €

· VOLANTE METAL · Volant métal · Metal handle · Ручка металлическая · Metalowa ręczka						
055010-VM	1/2" caño 10cm	8431977208625		10		27,7850
055014-VM	1/2" caño 14cm	8431977208632		6		33,0174

· VOLANTE ABS CROMADO

· Voltant ABS chromé · Chrome-plated ABS handle

· Ручка из хромированного пластика · Plastikowa ręczka chromowana

055010-VPC	1/2" caño 10 cm	8431977208649		10		21,9480
055014-VPC	1/2" caño 14 cm	8431977208656		6		27,1675

60

· LLAVE DE REGULACIÓN ESCUADRA LARGA
· ROBINET D'ARRÊT À CLAPET LONG · EXTENDED ANGLE BALL VALVE
· ПЕРЕХ. МИНИ-КРАН УГЛОВОЙ С НР · ZAWÓR KULOWY, KĄTOWY WYDŁUŻONY



CODE €

· CROMO · Chromé · Chrome · Хромированный · Chrom						
060000	1/2" x 3/8"			120		6,2787

- MONTURA GRIFO PRESIÓN
 · TÈTE ROBINET PUISAGE · VALVE HEADWORK
 · ВЕНТИЛЬНАЯ ГОЛОВКА · GŁOWICA ZAWORU

17



CODE	↔	Barcode	⊗	□	⊞	€
017018	18 mm	8431977214732	25		200	6,6829
017026	26 mm					12,8523
017002	1/2"	8431977214725	25		200	7,8870

- VÁLVULA DESCARGA VÁTER CUATRO GUÍAS REFORZADA CON PLOMO
 · CHASSE D'EAU EN LAITON QUATRE GUIDES RENFORCÉE AVEC PLOMB
 · TOILET FLUSH VALVE FOUR GUIDES REIN FORCED WITH LEAD
 · КЛАПАН ДЛЯ СЛИВНОГО БАЧКА (УСИЛЕННЫЙ)
 · ZAWÓR DO SPŁUCZEK TOALETOWYCH, CZTERY PROWADNICE WZMOCNIONE

34



CODE	↔	Barcode	⊗	□	⊞	€
034000					25	33,5108

- FLOTADOR SILENCIOSO
 · VANNE FLOTTEUR SILENCIEUX · SILENT FLOAT VALVE
 · КЛАПАН ДЛЯ СЛИВНОГО БАЧКА БЕСШУМНЫЙ · ZAWÓR PŁYWAKOWY

47



CODE	↔	Barcode	⊗	□	⊞	€
047000	3/8"					9,8887

- FLOTADOR OLLETA
 · VANNE · FLOAT VALVE · КЛАПАН ДЛЯ СЛИВНОГО БАЧКА · ZAWÓR PŁYWAKOWY

48



CODE	↔	Barcode	⊗	□	⊞	€
048001	3/8"					7,1633
048002	1/2"					12,6809

- FLOTADOR VARILLA ROSCADA ASIEN TO INOXIDABLE
 · ROBINET À FLOTTEUR SIÈGE INOX À VIS · FLOAT VALVE THREADED ROD STAINLESS STEEL SEAT
 · КЛАПАН ДЛЯ СЛИВНОГО БАЧКА С РЕЗЬБОВЫМ СТЕРЖНЕМ
 · ZAWÓR PŁYWAKOWY Z GWINTOWANYM PRĘTEM I ZAMKNIĘCIEM ZE STALI NIERDZEWNEJ

481

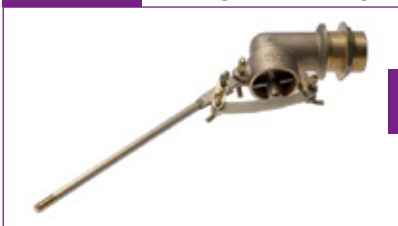

CODE	↔	Barcode	⊗	□	⊞	€
048102	1/2" Rosca 6/100	8431977213803		10	70	15,8385
048103	3/4" Rosca 7/100	8431977213810		10	40	25,4073
048104	1" Rosca 8/100	8431977213827		10	40	37,8434
048105	1.1/4" Rosca 9/100	8431977213834		2		73,3239
048106	1.1/2" Rosca 9/100	8431977213841		2		87,3956
048107	2" Rosca 9/100	8431977213858		2		135,7412

- FLOTADOR VARILLA DESLIZANTE ASIENTO INOXIDABLE
- ROBINET À FLOTTEUR SIÈGE INOX À GLISSER · FLOAT VALVE SLIDING ROD STAINLESS STEEL SEAT
- КЛАПАН ДЛЯ СЛИВНОГО БАЧКА С ПОДВИЖНЫМ СТЕРЖНЕМ
- ZAWÓR PŁYWAKOWY Z PRĘTEM GŁADKIM I ZAMKNIĘCIEM ZE STALI NIERDZEWNEJ

482



CODE	↔	Barcode	⊖	□	⊞	€
048202	1/2"	8431977213865	10	70		21,6792
048203	3/4"	8431977213872	10	40		27,6414
048204	1"	8431977213889	10	40		42,3342
048205	1.1/4"	8431977213896	2			90,2297
048206	1.1/2"	8431977213902	2			104,0448
048207	2"	8431977213919	2			153,9003

- BOYA LATÓN ESFÉRICA PARA FLOTADOR VARILLA ROSCADA
- FLOTTEUR LAITON SPHÉRIQUE POUR LEVIER À VIS · SPHERICAL BRASS FLOAT BALL FOR THREADED ROD
- ЛАТУННЫЙ ПОПЛАВОК ДЛЯ КЛАПАНА С РЕЗЬБОВЫМ СТЕРЖНЕМ
- MOSIĘŻNA KULA PŁYWAKA DO PRĘTA GWINTOWANEGO

4813



CODE	↔	Barcode	⊖	□	⊞	€
048131	diam. 9 cm - 3/8" Rosca 3/16					34,9248
048132	diam. 11 cm - 1/2" Rosca 6/100					39,4698
048133	diam. 13 cm - 3/4" Rosca 7/100					48,7751
048134	diam. 15 cm - 1" Rosca 8/100					70,4750
048135	diam. 18 cm - 1.1/4" Rosca 9/100					94,6849
048136	diam. 20 cm - 1.1/2" Rosca 9/100					136,6886
048137	diam. 23 cm - 2" Rosca 9/100					164,2101

- BOYA PLÁSTICO EXPANDIDO ESFÉRICA PARA FLOTADOR VARILLA ROSCADA
- FLOTTEUR PLASTIQUE SPHÉRIQUE POUR LEVIER À VIS · SPHERIC PLASTIC FLOAT BALL FOR THREADED ROD
- ПЛАСТИКОВЫЙ ПОПЛАВОК ДЛЯ КЛАПАНА С РЕЗЬБОВЫМ СТЕРЖНЕМ
- PLASTIKOWA KULA PŁYWAKA DO PRĘTA GWINTOWANEGO

4814



CODE	↔	Barcode	⊖	□	⊞	€
048141	diam. 9 cm - 3/8" Rosca 3/16					2,0140
048142	diam. 11 cm - 1/2" Rosca 6/100					4,0613
048143	diam. 13 cm - 3/4" Rosca 7/100					5,1242
048144	diam. 15 cm - 1" Rosca 8/100					6,1933
048145	diam. 20 cm - 1.1/4"/1.1/2" Rosca 9/100					9,3937
048147	diam. 23 cm - 2" Rosca 9/100					12,8209

- BOYA PLÁSTICO EXPANDIDO PLANA PARA FLOTADOR VARILLAS ROSCADA Y DESLIZANTE
- FLOTTEUR PLASTIQUE PLAT LEVIER À VIS ET À GLISSER
- FLAT PLASTIC FLOAT BALL FOR THREADED AND SLIDING ROD
- ПЛАСТИКОВЫЙ ПОПЛАВОК ДЛЯ КЛАПАНА С РЕЗЬБОВЫМ И ПОДВИЖНЫМ СТЕРЖНЕМ
- PLASTIKOWA KULA PŁYWAKA DO PRĘTA GWINTOWANEGO I PRĘTA GŁADKIEGO

4815



CODE	↔	Barcode	⊖	□	⊞	€
048152	diam. 12 cm - 1/2" Rosca 6/100					10,6777
048153	diam. 12 cm - 3/4" Rosca 7/100					10,5351
048154	diam. 15 cm - 1" Rosca 8/100					12,7348
048155	diam. 20 cm - 1.1/4"/1.1/2" Rosca 9/100					19,4579
048157	diam. 25 cm - 2" Rosca 9/100					28,4591

- BOYA COBRE PLANA PARA FLOTADOR VARILLA DESLIZANTE
- FLOTTEUR CUIVRE PLAT POUR LEVIER À GLISSER · COPPER FLAT FLOAT FOR SLIDING ROD
- МЕДНЫЙ ПЛОСКИЙ ПОПЛАВОК ДЛЯ КЛАПАНА С ПОДВИЖНЫМ СТЕРЖНЕМ
- MIEDZIANY PŁASKI PŁYWAK DO PRĘTA GŁADKIEGO

4826



CODE	←→		○ □ ▣	€
048262	diam. 12 cm - 1/2"			44,0849
048263	diam. 15 cm - 3/4"			52,4863
048264	diam. 17 cm - 1"			64,2204
048265	diam. 20 cm - 1.1/4"			95,5147
048266	diam. 23 cm - 1.1/2"			111,2539
048267	diam. 25 cm - 2"			138,4614

- BOYA POREXPAN
- FLOTEUR POREXPAN · POREXPAN FLAT BALL
- ПОПЛАВОК ИЗ СТИРОПОРА · KULA PŁYWAKA POLISTYRENOWA

4816



CODE	←→		○ □ ▣	€
048161	diam. 9 cm - 3/8" Rosca 3/16			1,4438
048162	diam. 11 cm - 1/2" Rosca 6/100			2,2607
048163	diam. 16 cm - 3/4" / 1" Rosca 7-8/100			3,7718

- ALARGO GRIFO
- RALLONGE MF POUR ROBINET · TAP EXTENSION MF
- УДЛИНИТЕЛЬНАЯ ГАЙКА · PRZEDŁUŻKA DO BATERII GZ/GW

16



CODE	←→		○ □ ▣	€
016003	1/2" x 1/2" x 3 cm	8431977205570	10 400	3,4464
016004	1/2" x 1/2" x 4 cm	8431977206829	10	4,1168
016005	1/2" x 1/2" x 5 cm	8431977205587	10 350	4,7541
016006	1/2" x 1/2" x 6 cm	8431977209035	10	5,7960
016007	1/2" x 1/2" x 7 cm	8431977211335	10	6,3010
016008	1/2" x 1/2" x 8 cm	8431977210642	10 225	7,2092
016010	1/2" x 1/2" x 10 cm	8431977206591	10 200	8,4957
016305	3/4" x 3/4" x 5 cm	8431977210468	5 200	7,7350
016310	3/4" x 3/4" x 10 cm	8431977210451	5 125	11,8458

· CROMO · Chromé · Chrome · Хромированный · Chrom

016003-C	1/2" x 1/2" x 3 cm	8431977203941	10 400	4,9297
016004-C	1/2" x 1/2" x 4 cm	8431977213049	10	5,5761
016005-C	1/2" x 1/2" x 5 cm	8431977203958	10 350	6,2482
016006-C	1/2" x 1/2" x 6 cm	8431977210666	10	8,0763
016007-C	1/2" x 1/2" x 7 cm	8431977211342	10	8,6717
016008-C	1/2" x 1/2" x 8 cm	8431977210659	10 225	9,7488
016010-C	1/2" x 1/2" x 10 cm	8431977203965	10 200	11,1657
016305-C	3/4" x 3/4" x 5 cm	8431977210475	5 125	10,3574
016310-C	3/4" x 3/4" x 10 cm	8431977209844	5	15,1156

- CONJUNTO PLACA-CODO
- APPLIQUE AVEC COUDES · WALL PLATE WITH ELBOWS
- НАБОР: УГОЛОК С МЕТАЛЛИЧЕСКОЙ ПЛАСТИНОЙ · LISTWA BATERYJNA

9901



CODE	←→		○ □ ▣	€
· ROSCAR-SOLDAR · Fileter-souder · Thread-weld · Резьба-Сварка · Gwint-Lut				
990100152	15 x 1/2" x 150 mm		75	9,9070



· ROSCAR-ROSCAR · Fileter-fileter · Thread-thread · Резьба - Резьба · Gwint - Gwint				
990100002	1/2" x 1/2" x 150 mm		75	11,5128



61

- CONEXIÓN MALLA ACERO INOXIDABLE
- MAILLE ACIER INOX · STAINLESS STEEL FLEXIBLE CONNECTOR
- ГИБКАЯ ПОДВОДКА ИЗ НЕРЖАВЕЮЩИЙ СТАЛИ
- PRZYŁĄCZE ELASTYCZNE Z OPLOTEM ZE STALI NIERDZEWNEJ



M3/8" H3/8"

CODE  €

CODE	Length	Price (€)
061015MH1	15 cm	5,1457
061020MH1	20 cm	5,4885
061025MH1	25 cm	5,8325
061030MH1	30 cm	6,1752
061040MH1	40 cm	6,8621

M1/2" H1/2"

CODE  €

CODE	Length	Price (€)
061020MH2	20 cm	6,5258
061025MH2	25 cm	6,8576
061030MH2	30 cm	7,2058
061035MH2	35 cm	7,5480
061040MH2	40 cm	7,8912
061050MH2	50 cm	8,5764
061060MH2	60 cm	9,2639

M3/8" H1/2"

CODE  €

CODE	Length	Price (€)
061015MH102	15 cm	5,8325
061020MH102	20 cm	5,9709
061025MH102	25 cm	6,2779
061030MH102	30 cm	6,7599

M1/2" H3/8"

CODE  €

CODE	Length	Price (€)
061015MH201	15 cm	5,5232
061025MH201	25 cm	6,3129
061030MH201	30 cm	6,6578
061035MH201	35 cm	6,8621
061040MH201	40 cm	7,3415

M3/4" H3/4"

CODE  €

CODE	Length	Price (€)
061020MH3	20 cm	13,5280
061030MH3	30 cm	14,8265
061040MH3	40 cm	16,7756
061050MH3	50 cm	18,2505

M1" H1"

CODE  €

CODE	Length	Price (€)
061030MH4	30 cm	51,6513
061040MH4	40 cm	56,6341
061050MH4	50 cm	61,2373

H3/8" H3/8"

CODE  €

CODE	Length	Price (€)
061015H1	15 cm	4,7700
061020H1	20 cm	5,2836
061025H1	25 cm	5,6268
061030H1	30 cm	5,9709
061035H1	35 cm	6,2779
061040H1	40 cm	6,6219
061060H1	60 cm	7,9962

H1/2" H1/2"

CODE  €

CODE	Length	Price (€)
061015H2	15 cm	5,8735
061020H2	20 cm	6,3883
061025H2	25 cm	6,7244
061030H2	30 cm	7,0682
061035H2	35 cm	7,4140
061040H2	40 cm	7,7546
061050H2	50 cm	8,4391
061060H2	60 cm	9,1257

H1/2" H3/8"

CODE  €

CODE	Length	Price (€)
061015H201	15 cm	5,4885
061020H201	20 cm	5,8325
061025H201	25 cm	6,1752
061030H201	30 cm	6,5186
061035H201	35 cm	5,8351
061040H201	40 cm	7,2046

- CONJUNTO MONOBLOC RECTO NIQUELADO
· RACCORD UNION MELANGEUR NICKELÉE · NICKEL-PLATED STRAIGHT TAP CONNECTOR
· ПЕРЕХОДНИК ДЛЯ КРЕПЛЕНИЯ СМЕСИТЕЛЯ НИКЕЛЬ · PRZYŁĄCZE BATERYJNE NIKLOWANE

73

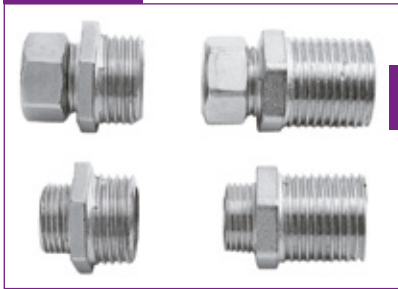





CODE	←→					€
· JUEGO COMPLETO · Jeu complet · Complete set · Полный комплект · Zestaw						
073000-X	corto - court - short	8431977203323	25	750		2,7812
073000-Z	largo - long - long	8431977201190	25	500		3,4076
· CUERPO · Corps · Body · Переходник · Korpus						
073100-X	corto - court - short					1,6795
073100-Z	largo - long - long					2,4802

- CONJUNTO MONOBLOC CURVO NIQUELADO
· RACCORD UNION MELANGEUR COUDE NICKELÉE · NICKEL - PLATED BENT TAP CONNECTOR
· УГОЛОК С ГАЙКОЙ НИКЕЛИРОВАННЫЙ · PRZYŁĄCZE BATERYJNE KĄTOWE, NIKLOWANE

73U







CODE	←→					€
· JUEGO COMPLETO · Jeu complet · Complete set · Полный комплект · Zestaw						
073000-U	1/2"x3/8"	8431977201206	25	400		4,4919
· CUERPO · Corps · Body · Переходник · Korpus						
073100-U	1/2"x3/8"	8431977201770	25			3,2994

- JUEGO DE FLORONES Y EXCÉNTRICAS
· JEU DE FLEURON ET EXCENTRIQUES · SET OF ROSETTES AND ECCENTRICS
· НАБОР: РОЗЕТКИ И ЭКСЦЕНТРИКИ · KOMPLET MIMOŚRODY I ROZETY

97







CODE	←→					€
· NORMAL · Normal · Regular · Обычный · Długość standardowa						
09704000						11,7156
· ANCHO · Extra large · Extra wide · Широкий · Długość wydłużona						
09705000	D.85					27,7478

- ACCESORIOS PARA RADIADORES DE ALUMINIO
· ACCESSOIRES POUR RADIATEURS EN ALUMINIUM · ACCESSORIES FOR ALUMINIUM RADIATORS
· АКССУАРЫ ДЛЯ АЛЮМИНИЕВЫХ РАДИАТОРОВ · ТЕРМОПЛАСТИЧЕСКОЕ КРЕПЛЕНИЕ · PODPORA TERMOPLASTYCZNA

561



CODE	←→					€
· SOPORTE TERMOPLÁSTICO · Support thermoplastique · Thermoplastic support						
· Термопластическое крепление · Podpora termoplastyczna						
561000	regulable hasta 24 mm en altura					0,8814

Características técnicas:

- Poliacetel
- Regulable hasta 24 mm en altura
- Color: blanco
- Estable, sólido, rígido y con un amplio intervalo de temperatura

Technical features:

- Polyacetel
- Adjustable up to 24 mm in height
- Color: white
- Stable, solid, hard and with a wide temperature range

- JUNTA TERMOPLÁSTICA CON REBORDE
· Joint à brides thermoplastique · Thermoplastic flanged gasket
· Термопластическая фланцевая прокладка
· Uszczelka termoplastyczna z kołnierzem



5610004	1"					0,1092
---------	----	--	--	--	--	--------

Características técnicas:

- Caucho termoplástico
- 42x33x1,5 mm
- Color: blanco
- Temperatura continua de trabajo: -40°C a 135°C
- Excelente flexibilidad

Technical features:

- Thermoplastic rubber
- 42x33x1.5 mm
- Color: white
- Continuous working temperature: -40°C a 135°C
- Excellent flexibility



99040

· COLUMNA FUNDIDA PARA BATERÍA BAÑO
· COLONETTE FONDUE POUR ROBINET DE BAINOIRE · CAST COLUMN FOR BATH MIXER
· УГОЛОК (ЛИТОЙ) ДЛЯ КРЕПЛЕНИЯ СМЕСИТЕЛЯ · KOLUMNA ODLEWANA DO BATERII ŁAZIENKOWEJ

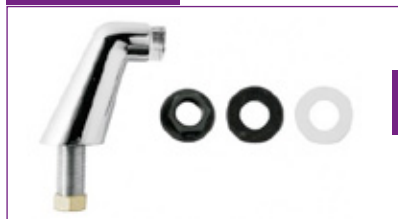

CODE



· CLÁSICA MM, ALTURA 70 mm - CON TUERCA 14x1/2"
· Classique mm, hauteur 70 mm - avec ecrou 14x1/2"
· Mm classic column, 70 mm in height - with 14x1/2" nut
· Классический нн, высота 70 мм с гайкой 14x1/2"
· Klasyczna gz/gz, wysokość 70 mm - nakrętka 14x1/2"

99040010	M 1/2" - M 3/4"	8431977214114	8	48	31,3522
----------	-----------------	---------------	---	----	---------



· CLÁSICA MM, ALTURA 70 mm - SIN TUERCA 14x1/2"
· Classique MM, hauteur 70 mm - sans ecrou 14x1/2"
· MM classic column, 70 mm in height - without 14x1/2" nut
· Классический НН, высота 70 мм без гайкой 14x1/2"
· Klasyczna GZ/GZ, wysokość 70 mm - bez nakrętki 14x1/2"

99040000	M 1/2" - M 3/4"	8431977211045	8	48	30,0530
----------	-----------------	---------------	---	----	---------

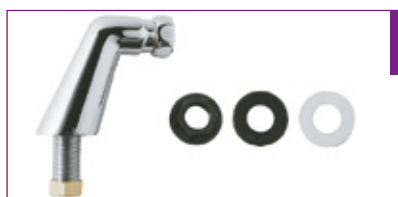

· CLÁSICA MH, ALTURA 70 mm - CON TUERCA 14x1/2"
· Classique MF, hauteur 70 mm - avec ecrou 14x1/2"
· MF classic column, 70 mm in height - with 14x1/2" nut
· Классический НВ, высота 70 мм с гайкой 14x1/2"
· Klasyczna GZ/GW, wysokość 70 mm - nakrętka 14x1/2"

99040200	M 1/2" - tuerca loca 3/4"		8		33,3292
----------	---------------------------	--	---	--	---------

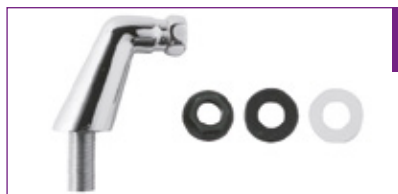

· CLÁSICA MH, ALTURA 70 mm - SIN TUERCA 14x1/2"
· Classique MF, hauteur 70 mm - sans ecrou 14x1/2"
· MF classic column, 70 mm in height - without 14x1/2" nut
· Классический НВ, высота 70 мм без гайки 14x1/2"
· Klasyczna GZ/GW, wysokość 70 mm - bez nakrętki 14x1/2"

99040110	M 1/2" - tuerca loca 3/4"		8		32,5759
----------	---------------------------	--	---	--	---------



· CON BASE MM, ALTURA 70 mm - CON TUERCA 14x1/2"
· À embase MM, hauteur 70 mm - avec ecrou 14x1/2"
· MM column with base, 70 mm in height - with 14x1/2" nut
· С основанием НН, высота 70мм с гайкой 14x1/2"
· Z podstawą GZ/GZ, wysokość 70 mm - nakrętka 14x1/2"

99040170	M 1/2" - M 1/2"	8431977211212	10		25,5343
99040180	M 1/2" - M 3/4"	8431977211038	10		25,8818



· CON BASE MM, ALTURA 70 mm - SIN TUERCA 14x1/2"
· À embase MM, hauteur 70 mm - sans ecrou 14x1/2"
· MM column with base, 70 mm in height - without 14x1/2" nut
· С основанием НН, высота 70мм без гайки 14x1/2"
· Z podstawą GZ/GZ, wysokość 70 mm - bez nakrętki 14x1/2"

99040190	M 1/2" - M 3/4"	8431977211229	10		24,7075
99040120	M 1/2" - M 1/2"		10		24,3599



· CON BASE MH, ALTURA 70 mm - CON TUERCA 14x1/2"
· À embase MF, hauteur 70 mm - avec ecrou 14x1/2"
· MF column with base, 70 mm in height - with 14x1/2" nut
· С основанием НВ, высота 70мм с гайкой 14x1/2"
· Z podstawą GZ/GW, wysokość 70 mm - nakrętka 14x1/2"

99040150	M 1/2" - tuerca loca 1/2"	8431977211199	10		28,5681
99040160	M 1/2" - tuerca loca 3/4"	8431977211205	10		30,3276

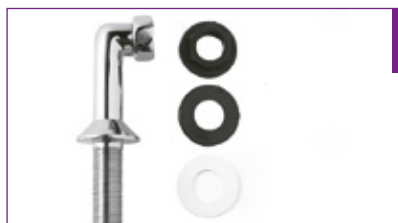

· CON BASE MH, ALTURA 70 MM - SIN TUERCA 14x1/2"
· À embase MF, hauteur 70 mm - sans ecrou 14x1/2"
· MF column with base, 70 mm in height - without 14x1/2" nut
· С основанием НВ, высота 70мм без гайки 14x1/2"
· Z podstawą GZ/GW, wysokość 70 mm - bez nakrętki 14x1/2"

99040130	M 1/2" - tuerca loca 1/2"		10		27,1964
99040140	M 1/2" - tuerca loca 3/4"		10		28,9940

- COLUMNA ESTAMPADA CON FLORÓN PARA BATERÍA BAÑO
- COLONETTE D'ETAMPAGE AVEC ROSACE POUR ROBINET DE BAIGNOIRE
- STAMP COLUMN WITH ROSETTE FOR BATH MIXER
- НАБОР ШТАМПОВАННЫЙ С РОЗЕТКОЙ ДЛЯ КРЕПЛЕНИЯ СМЕСИТЕЛЯ
- KOLUMNA ODKUWANA Z ROZĘTĄ DO BATERII ŁAZIENKOWEJ

99041



CODE



- MM, ALTURA 43 mm - CON TUERCA 14x1/2"
- MM, hauteur 43 mm - avec ecrou 14x1/2" · MM column, 43 mm in height - with 14x1/2" nut
- НН высота - 43 мм с гайкой 14x1/2" · GZ/GZ, wysokość 43 mm - nakrętka 14x1/2"

99041080	M 1/2" - M 1/2"		14	19,8213
99041090	M 1/2" - M 3/4"		14	19,9143



- MH, ALTURA 43 mm - CON TUERCA 14x1/2"
- Mf, hauteur 43 mm - avec ecrou 14x1/2" · Mf, 43 mm in height - with 14x1/2" nut
- Нв высота - 43 мм с гайкой 14x1/2" · GZ/GW, wysokość 43 mm - nakrętka

99041060	M 1/2" - tuerca loca 1/2"		14	21,7432
99041070	M 1/2" - tuerca loca 3/4"		14	23,8998



- MM, ALTURA 70 mm - CON TUERCA 14x1/2"
- Mm, hauteur 70 mm - avec ecrou 14x1/2" · Mm column, 70 mm in height - with 14x1/2" nut

99041120	M 1/2" - M 1/2"		14	21,0113
99041010	M 1/2" - M 3/4"	8431977211106	14	20,9516



- НН высота - 70 мм с гайкой 14x1/2" · Gz/gz, wysokość 70 mm - nakrętka 14x1/2"
- MM, ALTURA 70 mm - SIN TUERCA 14x1/2"

99041000	M 1/2" - M 3/4"		14	19,7763
99041130	M 1/2" - M 1/2"	8431977211113	14	19,7533



- Mm, hauteur 70 mm - sans ecrou 14x1/2" · Mm column, 70 mm in height - without 14x1/2" nut
- Нн высота - 70 мм без гайки 14x1/2" · Gz/gz, wysokość 70 mm - bez nakrętki 14x1/2"

99041100	M 1/2" - tuerca loca 1/2"		14	23,1277
99041110	M 1/2" - tuerca loca 3/4"		14	24,8861



- MH, ALTURA 70 mm - CON TUERCA 14x1/2"
- Mf, hauteur 70 mm - avec ecrou 14x1/2" · Mf column - 70 mm in height - with 14x1/2" nut
- Нв высота - 70 мм с гайкой 14x1/2" · Gz/gw, wysokość 70 mm - nakrętka 14x1/2"

99041140	M 1/2" - tuerca loca 1/2"		14	21,8278
99041150	M 1/2" - tuerca loca 3/4"		14	23,5863

· PLACA PARA GRIFO

99042

· RACCORD APPLIQUE D'EQUERRE · WALL PLATE TAP CONNECTOR
 · УГОЛОК ДЛЯ КРЕПЛЕНИЯ СМЕСИТЕЛЯ · PRZYŁĄCZE BATERYJNE NAŚCIENNE



CODE						€
· MM CON TUERCA 14x1/2" FIJACIÓN PIE ROSCADO						
· Mm avec ecrou 14x1/2" fixation par patte à vis · Mm with 14x1/2" nut threaded fixing						
· Нн с гайкой 14x1/2", прикручивается к стене · Gz/gz - nakrętka 14x1/2"						
99042800	M 1/2" - M 3/4"	8431977211144		20	120	18,1970
99042790	M 1/2" - M 1/2"	8431977211137		20	120	16,9513



· MM CON TUERCA 14x1/2" FIJACIÓN CON TORNILLOS						
· Mm avec ecrou 14x1/2" fixation par vis · Mm with 14x1/2" nut screwed fixing						
· Нн с гайкой 14x1/2", репится двумя шурупами к стене · Gz/gz - nakrętka 14x1/2"						
99042830	M 1/2" - M 3/4"	8431977215470		20	120	20,7698



· MM SIN TUERCA 14x1/2" FIJACIÓN PIE ROSCADO						
· Mm sans ecrou 14x1/2" fixation par patte à vis · Mm without 14x1/2" nut threaded fixing						
· Нн без гайки 14x1/2", прикручивается к стене · Gz/gz - bez nakrętki 14x1/2"						
99042810	M 1/2" - M 1/2"	8431977215463		20	120	14,7600
99042820	M 1/2" - M 3/4"	8431977211182		20	120	16,0057



· MM SIN TUERCA 14x1/2" FIJACIÓN CON TORNILLOS						
· Mm sans ecrou 14x1/2"-fixation part patte à vis · Mm without 14x1/2" nut screwed fixing						
· Нн без гайки 14x1/2", крепится двумя шурупами к стене · Gz/gz - bez nakrętki 14x1/2"						
99042840	M 1/2" - M 3/4"	8431977211175		20	120	18,5577



· MH CON TUERCA 14x1/2" FIJACIÓN PIE ROSCADO						
· Mf avec ecrou 14x1/2" fixation par patte à vis · Mf with 14x1/2" nut threaded fixing						
· Нв с гайкой 14x1/2", прикручивается к стене · Gz/gw - nakrętka 14x1/2"						
99042750	M 1/2" - tuerca loca 1/2"	8431977211120		20	120	19,5322
99042760	M 1/2" - tuerca loca 3/4"	8431977211168		20	120	20,7898



· MH SIN TUERCA 14x1/2" FIJACIÓN PIE ROSCADO						
· Mf sans ecrou 14x1/2" fixation par patte à vis · Mf without 14x1/2" threaded fixing						
· Нв без гайки 14x1/2", прикручивается к стене · Gz/gw - bez nakrętki 14x1/2"						
99042770	M 1/2" - tuerca loca 1/2"	8431977214084		20	120	17,3202
99042780	M 1/2" - tuerca loca 3/4"	8431977214602		20	120	18,5567

· COLUMN EXCÉNTRICA PARA BATERÍA BAÑO
· COLONETTE EXCENTREE POUR ROBINET DE BAIGNOIRE · ECCENTRIC COLUMN FOR BATH MIXER
· ЭКСЦЕНТРИЧЕСКОЕ КРЕПЛЕНИЕ ДЛЯ СМЕСИТЕЛЯ · MIMOŚRÓD DO BATERII ŁAZIENKOWEJ

99043



CODE



€

· MM, 22 mm ENTRE CENTROS
· Mm, 22 mm entre centres · Mm, 22 mm between centres
· Нн, 22мм между центрами · Gz/gz, mimośród 22mm

99043270	M 1/2" - M 1/2"		6	36,4420
99043280	M 1/2" - M 3/4"	8431977209103	6	43,3085



· MM, 50 mm ENTRE CENTROS
· MM, 50 mm entre centres · Mm, 50 mm between centres
· Нн, 50 мм между центрами · Gz/gz, mimośród 50mm

99043300	M 1/2" - M 3/4"	8431977209530	6	49,7152
----------	-----------------	---------------	---	---------

· MH, 22 mm ENTRE CENTROS
· Mf, 22 mm entre centres · Mf, 22 mm between centres
· Нв, 22мм между центрами · Gz/gw, mimośród 22mm

99043250	M 1/2" - H 1/2"		6	38,7173
99043260	M 1/2" - H 3/4"	8431977215951	6	44,2001



· MH, 50 mm ENTRE CENTROS
· Mf, 50 mm entre centres · Mf, 50 mm between centres
· Нв, 50 мм между центрами · Gz/gw, mimośród 50mm

99043290	M 1/2" - H 3/4"		6	48,5400
----------	-----------------	--	---	---------

· EXCÉNTRICA PLANA
· BOÎTE EXCENTREE · RECTANGULAR ECCENTRIC
· ЭКСЦЕНТРИК ПЛОСКИЙ · MIMOŚRÓD PROSTOKĄTNY

90044



CODE



€

· MM, 40 mm ENTRE CENTROS
· Mm, 40 mm entre centres · Mm, 40 mm between centres
· Нн, 40 мм между центрами · Gz/gz, mimośród 40 mm

99044550	M 1/2" - M 1/2"	8431977211304	14	13,6497
99044560	M 1/2" - M 3/4"	8431977211052	14	14,6335



· MH, 40 mm ENTRE CENTROS, SIN TUERCA LOCA
· Mf, 40 mm entre centres, sans écrou prisonnier · Mf, 40 mm between centres, without sliding nut
· Нв, 40 мм между центрами без передвижной гайки · Gz/gw, mimośród 40 mm, bez nakrętki ruchomej

99044510	M 1/2" - H 1/2"	8431977209110	14	13,1897
----------	-----------------	---------------	----	---------



· MH, 40 mm ENTRE CENTROS, CON TUERCA LOCA
· MF, 40 mm entre centres, avec écrou prisonnier · MF, 40 mm between centres, with sliding nut
· НВ, 40 мм между центрами с передвижной гайки · GZ/GW, mimośród 40 mm, z nakrętką ruchomą

99044520	M 1/2" - tuerca loca 1/2"	8431977211083	14	16,5045
99044530	M 1/2" - tuerca loca 3/4"	8431977211090	14	18,0666
99044540	M 3/4" - tuerca loca 1/2"	8431977211298	14	16,3271

- CONTRA CODO CON FLORÓN
- CONTRE COUDE AVEC ROSACE · S-ELBOW WITH ROSETTE
- S-УГОЛОК ДЛЯ КРЕПЛЕНИЯ СМЕСИТЕЛЯ · KOLANKO "S" Z ROZETA

99045



CODE



€

- MM, 32 mm ENTRE CENTROS
- Mm, 32 mm entre centres · Mm, 32 mm between centres
- Нн, 32 мм между центрами · Gz/gz, mimośróđ 32 mm

99045600	M 3/8" - M 1/2"	8431977211243	8	19,3369
99045610	M 1/2" - M 1/2"	8431977211250	8	18,1281
99045620	M 3/8" - M 3/4"	8431977209523	8	21,1553
99045630	M 1/2" - M 3/4"	8431977211267	8	18,9038



- MH, 32mm ENTRE CENTROS
- MF, 32mm entre centres · MF, 32mm between centres
- НВ, 32 мм между центрами · GZ/GW, mimośróđ 32 mm

99045570	M 3/8" - tuerca loca 1/2"		8	18,7498
99045580	M 1/2" - tuerca loca 1/2"	8431977211236	8	22,2211
99045590	M 1/2" - tuerca loca 3/4"		8	23,4786

99046 · CODO ESCUADRA
· RACCORD EQUERRE · SQUARE ELBOW · УГОЛОК · KOLANO KĄT PROSTY



CODE	↔	Barcode	⊙	□	⊞	€
· MM · MM · MM · HP · GZ/GZ						
99046920	M 1/2" - M 1/2"	8431977214466	20			10,5240
99046930	M 3/4" - M 3/4"	8431977214473	10			18,8560



· MH · MF · MF · HB · GZ/GW						
99046870	M 1/2" - tuerca loca 1/2"	8431977211076	20			13,0801
99046880	M 1/2" - tuerca loca 3/4"	8431977211274	20			14,4630
99046890	M 3/4" - tuerca loca 3/4"	8431977211281	10			18,7650



99046900	M 1/2" - H 1/2"	8431977214459	20			12,1694
99046910	M 3/4" - H 3/4"	8431977214190	10			16,4250



· HH · FF · FF · BP-BP · GW/GW						
99046850	tuerca loca 1/2" - tuerca loca 1/2"		12			16,4877
99046860	tuerca loca 1/2" - tuerca loca 3/4"		12			16,4064
99046940	tuerca loca 3/4" - tuerca loca 3/4"	8431977215944	12			17,7255

· CAÑO PARA GRIFO BAÑO DUCHA CON INVERSOR

9095 · BEC BAIN DOUCHE AVEC INVERSEUR · SPOUT FOR BATH SHOWER MIXER WITH DIVERTER
· НОСИК ДЛЯ ПОДКЛЮЧЕНИЯ ДУША (КРАН) · WYLEWKA DO BATERII PRYSZNI COWEJ Z PRZEŁĄCZNIKIEM



CODE	↔	Barcode	⊙	□	⊞	€
90959260	1/2"	8431977211311	10	60		49,3021



- CODO HEMBRA
· COUDE FER-CUIVRE FEMELLE · ELBOW F.I. x Cu
· УГОЛОК С ВНУТРЕННЕЙ РЕЗЬБОЙ (ПОД ПАЙКУ) · KOLANO GW/Cu

90 GCu



CODE	↔	Barcode	⊘	□	⊞	€
G-090121	12 x 3/8"	8431977202791	10		500	3,5640
G-090141	14 x 3/8"	8431977201527	10		500	3,3148
G-090151	15 x 3/8"	8431977215708	25		500	2,7908
G-090122	12 x 1/2"	8431977201510	10		500	2,9292
G-090142	14 x 1/2"	8431977201534	10		300	3,3188
G-090152	15 x 1/2"	8431977201565	25		500	3,3368
G-090162	16 x 1/2"	8431977201596	10		300	3,4500
G-090182	18 x 1/2"	8431977201619	25		400	3,8556
G-090222	22 x 1/2"	8431977201633	10		250	5,7028
G-090153	15 x 3/4"	8431977201589	10		300	6,2488
G-090163	16 x 3/4"	8431977201602	10		250	5,5316
G-090183	18 x 3/4"	8431977201626	10		300	5,7328
G-090223	22 x 3/4"	8431977201640	10		250	6,1976
G-090283	28 x 3/4"	8431977201664	10		180	10,4560
G-090224	22 x 1"	8431977201657	10		180	10,2516
G-090284	28 x 1"	8431977201671	10		120	12,1488
G-090285	28 x 1.1/4"					23,9456
G-090355	35 x 1.1/4"	8431977204566	5		75	20,4904
G-090426	42 x 1.1/2"					38,7492
G-090547	54 x 2"					66,4128



· ROSCA LARGA · Vis large · Long thread · С удлиненной резьбой · Długi gwint

G-090142-L	14 x 1/2"	8431977203484	10		400	4,6112
G-090152-L	15 x 1/2"	8431977201572	25			4,1316



· CUERPO LARGO · Long body · Corps large · Długi gwint długie ciało · С удлиненной

G-090122-LS	12 x 1/2" - 41,5 mm	8431977215692	10			33,5756
G-090142-LS	14 x 1/2" - 43 mm	8431977215708	10		150	33,5756
G-090162-LS	16 x 1/2" - 43 mm	8431977215715	10		150	33,5756

● Nuevo · Nouvelle
● New · новый · Nowy

- CODO MACHO
· COUDE FER CUIVRE MÂLE · ELBOW M.I. x CU
· УГОЛОК С НАРУЖНОЙ РЕЗЬБОЙ (ПОД ПАЙКУ) · KOLANO GZ/Cu

92 GCu



CODE	↔	Barcode	⊘	□	⊞	€
G-092121	12 x 3/8"	8431977201688	10		600	2,9256
G-092141	14 x 3/8"	8431977201701	10		400	3,4108
G-092151	15 x 3/8"	8431977201725	25		1000	3,3008
G-092122	12 x 1/2"	8431977201695	10		500	3,1056
G-092142	14 x 1/2"	8431977203095	10		500	3,2408
G-092152	15 x 1/2"	8431977201732	25		500	4,0812
G-092162	16 x 1/2"	8431977203644	10		400	3,5468
G-092182	18 x 1/2"	8431977203125	25		400	3,9452
G-092222	22 x 1/2"	8431977201794	10		300	6,5604
G-092153	15 x 3/4"					4,5932
G-092163	16 x 3/4"	8431977201756	10		300	4,7724
G-092183	18 x 3/4"	8431977201787	10		350	4,8036
G-092223	22 x 3/4"	8431977201800	10		300	5,3240
G-092284	28 x 1"	8431977201817	10		120	14,5208
G-092355	35 x 1.1/4"				75	29,8160
G-092426	42 x 1.1/2"				40	50,8568
G-092547	54 x 2"					75,9948

- CODO UNIÓN MACHO
- COUDE UNION FER-CUIVRE MÂLE · BENT UNION CONNECTOR M.I.xCU
- УГОЛОК С "АМЕРИКАНКОЙ" (ПОД ПАЙКУ) · ŚRUBUNEK KĄTOWY GZ/Cu

98 GCu



CODE	↔	Barcode	Ø	□	☐	€
G-098121	12 x 3/8"				300	9,2516
G-098142	14 x 1/2"	8431977213445	10		180	11,6528
G-098152	15 x 1/2"	8431977203149	10		200	10,6904
G-098162	16 x 1/2"	8431977213933	10		100	10,8644
G-098182	18 x 1/2"	8431977213780	10		200	10,9420
G-098183	18 x 3/4"	8431977214565	5		150	16,5720
G-098223	22 x 3/4"	8431977213926	5		125	16,4680
G-098224	22 x 1"					28,4740
G-098284	28 x 1"				60	32,3792
G-098355	35 x 1.1/4"				50	62,3656

- TE HEMBRA
- TE FER-CUIVRE FEMELLE · TEE F.I. BRANCH x Cu
- ТРОЙНИК С ВНУТРЕННЕЙ РЕЗЬБОЙ (ПОД ПАЙКУ) · TRÓJNIK Cu/GW/Cu

130 GCu



CODE	↔	Barcode	Ø	□	☐	€
G-130121	12 x 3/8"	8431977201831	10		500	3,7016
G-130151	15 x 3/8"	8431977201862	25		500	3,6948
G-130122	12 x 1/2"	8431977201848	10		500	4,2792
G-130142	14 x 1/2"	8431977201855	10		400	3,8236
G-130152	15 x 1/2"	8431977201879	25		400	4,1808
G-130162	16 x 1/2"	8431977201886	10		400	4,4572
G-130182	18 x 1/2"	8431977201893	25		300	4,4776
G-130222	22 x 1/2"	8431977201916	10		200	8,7408
G-130282	28 x 1/2"	8431977206430	5		125	17,2636
G-130183	18 x 3/4"	8431977201909	10		200	8,9976
G-130223	22 x 3/4"	8431977201923	10		180	9,0544
G-130283	28 x 3/4"	8431977206447	5		80	24,8056
G-130224	22 x 1"	8431977201930	10		120	11,1704
G-130284	28 x 1"	8431977205365	10		100	15,8452
G-130355	35 x 1.1/4"				50	34,6148
G-130426	42 x 1.1/2"				30	53,7352
G-130547	54 x 2"				15	84,9796

- CRUZ SOLDAR
- CROIX FER-CUIVRE · EQUAL CROSS Cu
- КРЕСТОВИНА (ПОД ПАЙКУ) · CZWÓRNIK Cu

180 Cu



CODE	↔	Barcode	Ø	□	☐	€
G-180015	15	8431977201947	10		300	8,1544
G-180018	18	8431977201954	10		250	8,9460
G-180022	22	8431977203620	10		120	16,7400
G-180028	28	8431977206454	5		75	26,3812
G-180035	35					46,4152
G-180042	42					56,9652
G-180054	54					111,9592



· ENTRONQUE MACHO

243 GCu

· MANCHON FER-CUIVRE MÂLE · STRAIGHT CONNECTOR M.I. x Cu
· ПЕРЕХОДНИК С НАРУЖНОЙ РЕЗЬБОЙ (ПОД ПАЙКУ) · NYPEL GZ/Cu



CODE	↔	Barcode	Ø	□	田	€
G-243101	10 x 3/8"	8431977201961	25		1000	2,0020
G-243121	12 x 3/8"	8431977201985	10		1000	1,8352
G-243141	14 x 3/8"	8431977202005	10		1000	1,7584
G-243151	15 x 3/8"	8431977202036	25		1000	1,7584
G-243102	10 x 1/2"	8431977201978	25		1000	2,4236
G-243122	12 x 1/2"	8431977201992	10		1000	2,3020
G-243142	14 x 1/2"	8431977202012	10		750	2,3156
G-243152	15 x 1/2"	8431977202043	25		750	2,2272
G-243162	16 x 1/2"	8431977202067	10		750	2,2928
G-243182	18 x 1/2"	8431977202098	25		750	2,5996
G-243222	22 x 1/2"	8431977202135	25		500	3,2084
G-243143	14x3/4"	8431977203736	10		500	3,6732
G-243153	15 x 3/4"	8431977202050	25		500	3,4760
G-243163	16x3/4"	8431977202081	10		500	3,4652
G-243183	18 x 3/4"	8431977202104	25		500	3,3168
G-243223	22 x 3/4"	8431977202142	25		500	3,5896
G-243283	28 x 3/4"	8431977202173	10		250	6,1544
G-2432213	22 x 7/8"	8431977202128	25		350	5,7116
G-243224	22 x 1"	8431977202166	10		250	5,8948
G-243284	28 x 1"	8431977202180	10		250	5,2172
G-243354	35 x 1"	8431977207628	10		150	9,2492
G-243285	28 x 1.1/4"	8431977202197	10		150	10,1816
G-243355	35 x 1.1/4"	8431977208458	10		150	10,7312
G-243365	36 x 1.1/4"	8431977214091	10		100	14,1840
G-243425	42 x 1.1/4"	8431977204542	10		100	13,4904
G-243356	35 x 1.1/2"	8431977204580	5		100	15,0504
G-243426	42 x 1.1/2"	8431977208465	5		100	13,2532
G-243527	52 x 2"				50	26,3400
G-243547	54 x 2"				50	24,7668
G-243648	64 x 2.1/2"				30	49,2640
G-243678	67 x 2.1/2"				30	53,5512
G-243799	79,4 x 3"					76,6228
G-24310440	104 x 4"					419,1464



Nuevo · Nouvelle
New · новый · Nowy

· ENLACE HEMBRA

270 GCu

· MANCHON FER-CUIVRE F · STRAIGHT CONNECTOR F.I. x Cu
· ПЕРЕХОДНИК С ВНУТРЕННЕЙ РЕЗЬБОЙ (ПОД ПАЙКУ) · MUFA GW/Cu



CODE	↔	Barcode	Ø	□	☐	€
G-270121	12 x 3/8"	8431977202203	10		1000	1,6336
G-270141	14 x 3/8"	8431977202227	10		1000	1,8220
G-270151	15 x 3/8"	8431977202258	25		1000	1,7628
G-270122	12 x 1/2"	8431977202210	10		750	2,2140
G-270142	14 x 1/2"	8431977202234	10		850	2,6396
G-270152	15 x 1/2"	8431977202265	25		850	2,4272
G-270162	16 x 1/2"	8431977202289	10		800	2,2752
G-270182	18 x 1/2"	8431977202302	25		750	2,6292
G-270222	22 x 1/2"	8431977202326	25		500	3,1200
G-270143	14 x 3/4"	8431977203262	10		500	3,0928
G-270153	15 x 3/4"	8431977202272	25		600	3,0788
G-270163	16 x 3/4"	8431977202296	10		500	3,0180
G-270183	18 x 3/4"	8431977202319	25		500	2,9708
G-270223	22 x 3/4"	8431977202333	25		400	3,1960
G-270283	28 x 3/4"	8431977202357	10		250	5,6952
G-270224	22 x 1"	8431977202340	10		250	5,3484
G-270284	28 x 1"	8431977202364	10		250	5,9328
G-270355	35 x 1.1/4"	8431977205402	5		100	12,1480
G-270426	42 x 1.1/2"	8431977207499	5		100	14,9160
G-270547	54 x 2"				50	26,8888
G-270648	64 x 2.1/2"					59,5044

Nuevo · Nouvelle
New · новый · Nowy

· TAPÓN HEMBRA

301 Cu

· BOUCHON FEMELLE À SOUDER · BLANKING CAP Cu
· ЗАГЛУШКА (ПОД ПАЙКУ) · KOREK Cu



CODE	↔	Barcode	Ø	□	☐	€
G-301012	12	8431977202371	10		1000	1,7892
G-301014	14	8431977202388	10		1000	1,8352
G-301015	15	8431977202395	25		1000	1,4044
G-301016	16	8431977202401	10		1000	1,8748
G-301018	18	8431977202418	25		1000	1,7888
G-301022	22	8431977202425	25		750	2,6604
G-301028	28	8431977202432	25		500	3,6044
G-301035	35	8431977202449	10		250	6,3208
G-301042	42	8431977205532	10		200	8,9672
G-301054	54	8431977208700	5		120	14,7468

· EMPALME UNIÓN 3 PIEZAS SOLDAR

340 Cu

· RACCORD UNION FER-CUIVRE · CONE UNION Cu x Cu
· "АМЕРИКАНКА" ПОД ПАЙКУ · ŚRUBUNEK Cu/Cu



CODE	↔	Barcode	Ø	□	☐	€
G-340012	12	8431977208397	10			7,2584
G-340014	14	8431977212493	10			8,0564
G-340015	15	8431977214480	10		300	8,2216
G-340016	16	8431977213629	10		300	9,4684
G-340018	18	8431977206676	10		300	8,4824
G-340022	22	8431977206706	10		150	14,1192
G-340028	28				100	20,8016
G-340035	35				75	31,9376
G-340042	42				40	52,7912
G-340054	54				20	88,0604



- EMPALME UNIÓN 3 PIEZAS HEMBRA SOLDAR
- RACCORD UNION FEMALE FER-CUIVRE · CONE UNION F.I x Cu
- "АМЕРИКАНКА" С ВНУТРЕННЕЙ РЕЗЬБОЙ (ПОД ПАЙКУ) · ŚRUBUNEK GW/Cu

340 GCu



CODE	↔	Barcode	⊘	□	⊞	€
G-340121	12 x 3/8"	8431977207512	10			6,6952
G-340141	14 x 3/8"	8431977207536	10			6,5916
G-340122	12 x 1/2"	8431977214589	10			8,6284
G-340142	14 x 1/2"	8431977202982	10			8,3112
G-340152	15 x 1/2"	8431977214138	10	300		8,2760
G-340162	16 x 1/2"	8431977203002	10	300		8,8304
G-340182	18 x 1/2"	8431977206652	10	300		13,8500
G-340163	16 x 3/4"					8,1416
G-340183	18 x 3/4"	8431977206683	10	250		14,1836
G-340223	22 x 3/4"	8431977206713	10	300		12,6304
G-340224	22 x 1"	8431977207888	10	150		15,3856
G-340284	28 x 1"	8431977214787	5	100		20,5876
G-340285	28 x 1.1/4"					23,5228
G-340355	35 x 1.1/4"			80		32,2028
G-340426	42 x 1.1/2"			40		47,0040
G-340547	54 x 2"			20		75,6212

- EMPALME UNIÓN 3 PIEZAS MACHO SOLDAR
- RACCORD UNION MÂLE FER-CUIVRE · CONE UNION M.I. x Cu
- "АМЕРИКАНКА" С НАРУЖНОЙ РЕЗЬБОЙ (ПОД ПАЙКУ) · ŚRUBUNEK GZ/Cu

341 GCu



CODE	↔	Barcode	⊘	□	⊞	€
G-341121	12 x 3/8"	8431977207550	10			7,2448
G-341141	14 x 3/8"	8431977208380	10			6,7536
G-341122	12 x 1/2"	8431977214572	10			9,0016
G-341142	14 x 1/2"	8431977203385	10			9,1460
G-341152	15 x 1/2"	8431977206638	10	300		9,0576
G-341162	16 x 1/2"	8431977200957	10	300		9,4132
G-341182	18 x 1/2"	8431977206669	10	300		8,6212
G-341143	14 x 3/4"					10,3968
G-341163	16 x 3/4"	8431977201435	10			10,1216
G-341183	18 x 3/4"	8431977213773	10	250		9,9832
G-341223	22 x 3/4"	8431977201442	10	150		14,1140
G-341224	22 x 1"	8431977207574	10	150		16,3064
G-341284	28 x 1"			100		21,2340
G-341285	28 x 1.1/4"					22,6732
G-341325	32 x 1.1/4"					27,7260
G-341355	35 x 1.1/4"			80		33,0640
G-341426	42 x 1.1/2"			40		50,2488
G-341527	52 x 2"			20		91,7440
G-341547	54 x 2"			20		86,7752



Nuevo · Nouvelle
New · новый · Nowy

- CODO MURAL
- APPLIQUE FER-CUIVRE · WALL PLATE ELBOW
- УГОЛОК С КРЕПЛЕНИЕМ НА ДВА ВИНТА (ПОД ПАЙКУ) · KOLANO Z ŁAPAMI GW/Cu

472 GCu



CODE	↔	Barcode	⊘	□	⊞	€
G-472152	15 x 1/2"	8431977202531	25	350		4,6068
G-472182	18 x 1/2"	8431977202548	10	250		7,0500
G-472222	22 x 1/2"	8431977203194	10	200		11,8524
G-472183	18 x 3/4"	8431977203101	10	200		12,4852
G-472223	22 x 3/4"	8431977202555	10	160		8,3716
G-472284	28 x 1"					20,9280

- CODO MURAL BASE TRIANGULAR
- APPLIQUE FER-CUIVRE BASE TRIANGULER · WALL PLATE ELBOW TRIANGULAR BASE
- УГОЛОК С КРЕПЛЕНИЕМ НА ТРИ ВИНТА (ПОД ПАЙКУ) · KOLANO Z TRÓJKĄTNĄ ŁAPĄ GW/Cu

471 GCu



CODE	↔	Barcode	Ø	□	⊞	€
G-471122	12 x 1/2"	8431977203156	10	300		5,0028
G-471142	14 x 1/2"	8431977203163	10	300		5,5096
G-471152	15 x 1/2"	8431977203170	25	300		5,1068
G-471162	16 x 1/2"	8431977203378	10	300		5,1804

- RACOR DOS PIEZAS CURVO SOLDAR
- RACCORD 2 PIÈCES COUDÉ · BENT TAP CONNECTOR
- ДУГА С НАКИДНОЙ ГАЙКОЙ · ŁUKI BATTERYJNY

2A GCu

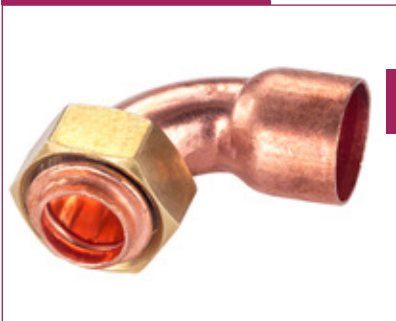

CODE	↔	Barcode	Ø	□	⊞	€
SIN PRECINTO · Sans trou pour scellé · Without seal hole · Без пломбы · Bez otworu na plombę						
G-2AGCU101	10 x 3/8"		25			8,2928
G-2AGCU121	12 x 3/8"		25	700		6,4852
G-2AGCU151	15 x 3/8"		25	700		7,4672
G-2AGCU122	12 x 1/2"		25	500		6,0208
G-2AGCU142	14 x 1/2"		25	500		6,9548
G-2AGCU152	15 x 1/2"		25	500		5,7644
G-2AGCU162	16 x 1/2"		25			7,1464
G-2AGCU182	18 x 1/2"		25	400		7,0532
G-2AGCU153	15 x 3/4"		25	300		9,2936
G-2AGCU163	16 x 3/4"		25			13,2352
G-2AGCU183	18 x 3/4"		25	300		8,7996
G-2AGCU223	22 x 3/4"		25	250		9,4292
G-2AGCU224	22 x 1"		25	150		15,1140
G-2AGCU284	28 x 1"		25			16,5212

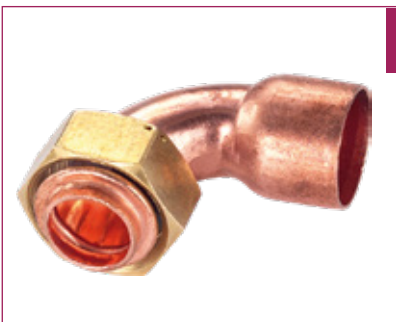

CODE	↔	Barcode	Ø	□	⊞	€
CON PRECINTO · Avec trou pour scellé · With seal hole · С пломбой · Z otworem na plombę						
G-2AGCU122P	12 x 1/2"		25	500		7,5492
G-2AGCU142P	14 x 1/2"		25	500		8,5196
G-2AGCU152P	15 x 1/2"		25	500		7,2528
G-2AGCU162P	16 x 1/2"		25			8,7252
G-2AGCU182P	18 x 1/2"		25	400		8,7016
G-2AGCU153P	15 x 3/4"		25	300		10,2948
G-2AGCU183P	18 x 3/4"		25	300		10,2620
G-2AGCU223P	22 x 3/4"		25	250		10,9596
G-2AGCU224P	22 x 1"		25	150		16,1636
G-2AGCU284P	28 x 1"		25			17,5588

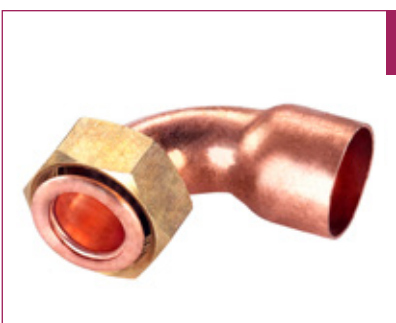

- PARA JUNTA PLANA · POUR JOINT PLAT · FOR FLAT SEAL
- ДЛЯ ПЛОСКОГО УПЛОТНЕНИЯ · DO USZCZELKI PŁASKIEJ

CODE	↔	Barcode	Ø	□	⊞	€
G-2AGCU152J	15 x 1/2"		25	500		5,8024
G-2AGCU182J	18 x 1/2"		25	400		7,1680
G-2AGCU183J	18 x 3/4"		25	300		8,9276
G-2AGCU284J	28 x 1"		25			16,3516

○ Nuevo · Nouvelle
 New · новый · Nowy



359 GLCu

- RACOR 2 PIEZAS CASQUILLO LARGO COBRE SOLDAR
- RACCORD 2 PIÈCES DROIT · STRAIGHT TAP CONNECTOR
- ПЕРЕХОДНИК (ПОД ПАЙКУ) · ZŁĄCZKA BATERYJNA PROSTA

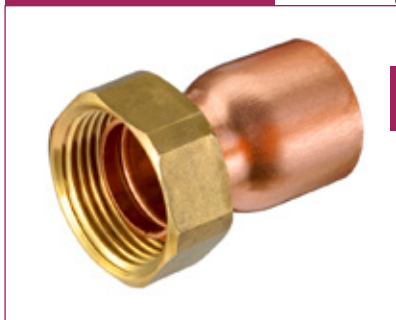

CODE



€

SIN PRECINTO · Sans trou pour scellé · Without seal hole · Без пломбы · Bez otworu na plombę

CODE	Dimensions	Material	Quantity	Weight	Price
G-359GL101	10 x 3/8"		25	1000	3,6968
G-359GL121	12 x 3/8"		25	1000	3,7440
G-359GL141	14 x 3/8"		25	1000	4,5192
G-359GL151	15 x 3/8"		25	1000	4,2184
G-359GL102	10 x 1/2"		25		5,0464
G-359GL122	12 x 1/2"		25	800	4,0596
G-359GL142	14 x 1/2"		25		4,2652
G-359GL152	15 x 1/2"		25	800	3,5280
G-359GL162	16 x 1/2"		25		4,3584
G-359GL182	18 x 1/2"		25	600	5,0396
G-359GL222	22 x 1/2"		25		8,6164
G-359GL143	14 x 3/4"		25		8,5476
G-359GL153	15 x 3/4"		25	500	5,7556
G-359GL163	16 x 3/4"		25		7,7884
G-359GL183	18 x 3/4"		25	500	5,6948
G-359GL223	22 x 3/4"		25	400	6,2976
G-359GL283	28 x 3/4"		25		12,9256
G-359GL184	18 x 1"		25		10,4844
G-359GL224	22 x 1"		25	250	10,1228
G-359GL284	28 x 1"		25	200	11,6160
G-359GL285	28 x 1.1/4"		10		19,1084
G-359GL355	35 x 1.1/4"		10		21,0536
G-359GL356	35 x 1.1/2"		10		28,5824
G-359GL426	42 x 1.1/2"		10		29,4672
G-359GL547	54 x 2"		5		52,1732
G-359GL1220	12 x 20/150				5,8564
G-359GL1520	15 x 20/150				5,5972
G-359GL1820	18 x 20/150				6,8292

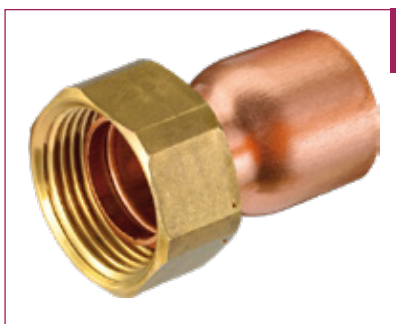

· CON PRECINTO · Avec trou pour scellé · With seal hole · С пломбой · Z otworem na plombę

CODE	Dimensions	Material	Quantity	Weight	Price
G-359GL102P	10 x 1/2"		25		6,0724
G-359GL122P	12 x 1/2"		25	800	5,0300
G-359GL142P	14 x 1/2"		25		5,4640
G-359GL152P	15 x 1/2"		25	800	4,9024
G-359GL162P	16 x 1/2"		25		5,3276
G-359GL182P	18 x 1/2"		25	600	6,0400
G-359GL222P	22 x 1/2"		25		10,0288
G-359GL143P	14 x 3/4"		25		9,3824
G-359GL153P	15 x 3/4"		25	500	6,9048
G-359GL163P	16 x 3/4"		25		7,4404
G-359GL183P	18 x 3/4"		25	500	6,6456
G-359GL223P	22 x 3/4"		25	400	7,2968
G-359GL283P	28 x 3/4"		25		14,1928
G-359GL184P	18 x 1"		25		12,6548
G-359GL224P	22 x 1"		25	250	11,4408
G-359GL284P	28 x 1"		25	200	13,5040
G-359GL285P	28 x 1.1/4"		10		21,4988
G-359GL355P	35 x 1.1/4"		10		21,8716
G-359GL356P	35 x 1.1/2"		10		31,7968
G-359GL426P	42 x 1.1/2"		10		32,7344
G-359GL547P	54 x 2"		5		58,1756

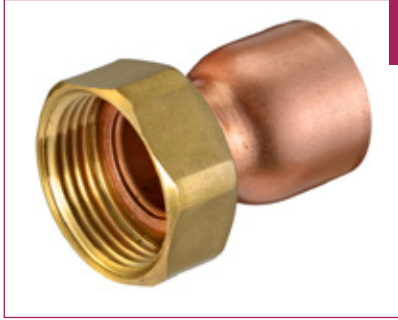

PARA JUNTA PLANA · POUR JOINT PLAT · FOR FLAT SEAL
ДЛЯ ПЛОСКОГО УПЛОТНЕНИЯ ·

G-359GL122J	12 x 1/2"		25	800	3,5800
G-359GL152J	15 x 1/2"		25	800	3,5444
G-359GL182J	18 x 1/2"		25	600	4,9460
G-359GL183J	18 x 3/4"		25	500	5,6556
G-359GL222J	22 x 1/2"		25		8,8344
G-359GL223J	22 x 3/4"		25	400	6,2908
G-359GL284J	28 x 1"		25	200	11,6568
G-359GL285J	28 x 1.1/4"		25		19,1788

 Nuevo · Nouvelle
New · новый · Nowy

1003 (85)

· PUENTE
· COURBE-SAUT DE TUYAUTERIE · CROSSOVER · ПЕРЕХОДНИК (МОСТИК) · OBEJŚCIE Cu



CODE	↔		○ □ ⊕	€
G-100315	15		250	9,8648
G-100318	18		150	13,4438
G-100322	22		75	21,0712



Racores de compresión para tubo de cobre
 Raccords à compression pour tube de cuivre · Compression fittings for copper tube
 Компрессионные фитинги для медной трубы · Złączki skręcane do rur miedzianych

· UNIÓN TUBO - TUBO PARA BICONO
 · UNION TUBE-TUBE POUR BICONE · STRAIGHT UNION TUBE FOR BICONE
 · СОЕДИНЕНИЕ ПРЯМОЕ (КОНУС) · ZŁĄCZKA PROSTA RURA/RURA

350



CODE	↔	Barcode	⊗	□	⊞	€
3500010	Ø10 x Ø10					4,5103
3500012	Ø12 x Ø12					4,2359
3500014	Ø14 x Ø14					5,4057
3500015	Ø15 x Ø15	8431977210345	10			5,4463
3500016	Ø16 x Ø16				250	5,1147
3500018	Ø18 x Ø18					6,2876
3500022	Ø22 x Ø22	8431977209769	5			7,7122

· UNIÓN TUBO - TUBO REDUCIDO PARA BICONO
 · UNION TUBE-TUBE POUR BICONE RÉDUIT · REDUCING STRAIGHT UNION TUBE FOR BICONE
 · ПЕРЕХОДНИК ПРЯМОЙ РЕДУКЦИОННЫЙ (КОНУС) · ZŁĄCZKA REDUKCYJNA RURA/RURA

350 R



CODE	↔	Barcode	⊗	□	⊞	€
3501012	Ø10 x Ø12	8431977210482	10			5,0422
3501014	Ø10 x Ø14					5,4157
3501214	Ø12 x Ø14					5,4157
3501215	Ø12 x Ø15					5,4157
3501416	Ø14 x Ø16					5,4157
3501618	Ø16 x Ø18					6,1628
3501822	Ø18 x Ø22	8431977209646	10			7,4404

· UNIÓN TUBO MACHO PARA BICONO
 · UNION TUBE MÂLE POUR BICONE · STRAIGHT UNION TUBE MALE FOR BICONE
 · СОЕДИНЕНИЕ ПРЯМОЕ (КОНУС), С ПЕРЕХОДОМ НА НР · ZŁĄCZKA PROSTA GZ/RURA

352



CODE	↔	Barcode	⊗	□	⊞	€
3521001	Ø10 x M3/8"	8431977209691	10			2,8248
3521201	Ø12 x M3/8"					2,8976
3521401	Ø14 x M3/8"					3,5212
3521002	Ø10 x M1/2"	8431977207871	10			2,9990
3521202	Ø12 x M1/2"					3,2634
3521402	Ø14 x M1/2"					3,6133
3521502	Ø15 x M1/2"	8431977209776	10			3,5622
3521602	Ø16 x M1/2"					3,4870
3521802	Ø18 x M1/2"	8431977209400	10		250	3,9722
3522202	Ø22 x M1/2"	8431977209653	5			5,6324
3521203	Ø12 x M3/4"					3,9722
3521403	Ø14 x M3/4"					3,9722
3521503	Ø15 x M3/4"					4,3226
3521603	Ø16 x M3/4"					3,9722
3521803	Ø18 x M3/4"	8431977209707	10			4,8773
3522203	Ø22 x M3/4"	8431977209417	5			5,4651

- UNIÓN TUBO HEMBRA PARA BICONO
- UNION TUBE FEMELLE POUR BICONE · STRAIGHT FEMALE UNION TUBE FOR BICONE
- СОЕДИНЕНИЕ ПРЯМОЕ (КОНУС), С ПЕРЕХОДОМ НА ВР · ZŁĄCZKA PROSTA GW/RURA

354



CODE	↔	Barcode	⊖	□	⊞	€
3541001	Ø10 x H3/8"	8431977210352	10			3,0558
3541201	Ø12 x H3/8"					3,0367
3541401	Ø14 x H3/8"					3,4209
3541002	Ø10 x H1/2"	8431977209424	10			3,1763
3541202	Ø12 x H1/2"					3,1763
3541402	Ø14 x H1/2"					3,4888
3541502	Ø15 x H1/2"	8431977209783	10			3,4888
3541602	Ø16 x H1/2"					3,4888
3541802	Ø18 x H1/2"	8431977209790	10	250		4,7655
3541203	Ø12 x H3/4"					3,7043
3541403	Ø14 x H3/4"					3,8799
3541503	Ø15 x H3/4"					3,8799
3541603	Ø16 x H3/4"					3,8799
3541803	Ø18 x H3/4"					4,3212
3542203	Ø22 x H3/4"	8431977209806	5			6,3146

- CODO TUBO - TUBO PARA BICONO
- COUDE TUBE - TUBE POUR BICONE · ELBOW TUBE - TUBE FOR BICONE
- СОЕДИНЕНИЕ УГЛОВОЕ (КОНУС) · KOLANO RURA/RURA

356



CODE	↔	Barcode	⊖	□	⊞	€
3560010	Ø10 x Ø10	8431977210710	10			4,7896
3560012	Ø12 x Ø12	8431977209714	10		300	4,4359
3560014	Ø14 x Ø14					5,9740
3560015	Ø15 x Ø15	8431977209721	10			5,7606
3560016	Ø16 x Ø16					5,7606
3560018	Ø18 x Ø18	8431977209431	10			7,0561
3560022	Ø22 x Ø22	8431977209448	5			11,5716

- CODO TUBO - TUBO REDUCIDO PARA BICONO
- COUDE TUBE - TUBE POUR BICONE RÉDUIT · REDUCING ELBOW TUBE-TUBE FOR BICONE
- СОЕДИНЕНИЕ УГЛОВОЕ (КОНУС), С ПЕРЕХОДОМ НА ВР · KOLANO REDUKCYJNE RURA/RURA

356R



CODE	↔	Barcode	⊖	□	⊞	€
3561516	Ø15 x Ø16				250	7,0686



- CODO TUBO MACHO PARA BICONO
- COUDE TUBE MÂLE POUR BICONE · ELBOW TUBE MALE FOR BICONE
- СОЕДИНЕНИЕ УГЛОВОЕ (КОНУС), С ПЕРЕХОДОМ НА НР · KOLANO GZ/RURA

358



CODE	↔	Barcode	⊗	□	⊞	€
3581001	Ø10 x M3/8"					3,3811
3581201	Ø12 x M3/8"					3,1097
3581202	Ø12 x M1/2"	8431977209462	10		250	4,4165
3581402	Ø14 x M1/2"					4,0685
3581502	Ø15 x M1/2"	8431977209479	10			3,9536
3581602	Ø16 x M1/2"				200	3,9795
3581802	Ø18 x M1/2"					4,8137
3581203	Ø12 x M3/4"					4,8477
3581403	Ø14 x M3/4"					4,8384
3581503	Ø15 x M3/4"				200	4,6605
3581603	Ø16 x M3/4"				200	4,7172
3581803	Ø18 x M3/4"					5,4706
3582203	Ø22 x M3/4"					8,2521

- CODO TUBO HEMBRA PARA BICONO
- COUDE TUBE FEMELLE POUR BICONE · ELBOW TUBE FEMALE FOR BICONE
- СОЕДИНЕНИЕ УГЛОВОЕ (КОНУС), С ПЕРЕХОДОМ НА ВР · KOLANO GW/RURA

360



CODE	↔	Barcode	⊗	□	⊞	€
3601001	Ø10 x H3/8"					4,0150
3601201	Ø12 x H3/8"					4,3440
3601002	Ø10 x H1/2"	8431977209455	10			4,3858
3601202	Ø12 x H1/2"					4,2623
3601402	Ø14 x H1/2"					4,3017
3601502	Ø15 x H1/2"	8431977209745	10			4,4200
3601602	Ø16 x H1/2"					4,2623
3601802	Ø18 x H1/2"					5,4926
3601203	Ø12 x H3/4"					5,9466
3601403	Ø14 x H3/4"					5,4926
3601503	Ø15 x H3/4"					5,4926
3601603	Ø16 x H3/4"					5,4926
3601803	Ø18 x H3/4"					5,9496
3602203	Ø22 x H3/4"	8431977209813	5			7,3468

- CODO MURAL TUBO HEMBRA PARA BICONO
- APPLIQUE TUBE FEMELLE POUR BICONE · WALL PLATE ELBOW TUBE FEMALE FOR BICONE
- УГОЛ С КРЕПЛЕНИЕМ (КОНУС), С ПЕРЕХОДОМ НА ВР · KOLANO Z ŁAPAMI GW/RURA

362



CODE	↔	Barcode	⊗	□	⊞	€
3621202	Ø12 x H1/2"					5,5773
3621402	Ø14 x H1/2"					5,3741
3621502	Ø15 x H1/2"	8431977209752	10			5,5730
3621602	Ø16 x H1/2"	8431977212561	10			5,8420

- TE TUBO PARA BICONO
- TE TUBE POUR BICONE · TEE TUBE FOR BICONE
- ТРОЙНИК (КОЛУС) · TRÓJNIK RURA/RURA/RURA

364



CODE	↔	Barcode	⊘	□	⊞	€
3640010	Ø10 x Ø10 x Ø10	8431977210727	10			6,3632
3640012	Ø12 x Ø12 x Ø12	8431977210109	10			6,3632
3640014	Ø14 x Ø14 x Ø14					7,9619
3640015	Ø15 x Ø15 x Ø15					8,1478
3640016	Ø16 x Ø16 x Ø16					7,9619
3640018	Ø18 x Ø18 x Ø18					9,8249
3640022	Ø22 x Ø22 x Ø22					16,2604

- TE TUBO HEMBRA PARA BICONO
- TE TUBE FEMELLE POUR BICONE · TEE TUBE FEMALE FOR BICONE
- ТРОЙНИК (КОЛУС), С ПЕРЕХОДОМ НА ВР · TRÓJNIK RURA/GW/RURA

368



CODE	↔	Barcode	⊘	□	⊞	€
3681202	Ø12 x H1/2" x Ø12	8431977209738	10			6,9770
3681402	Ø14 x H1/2" x Ø14					7,2340
3681502	Ø15 x H1/2" x Ø15	8431977210116	10			7,2340
3681602	Ø16 x H1/2" x Ø16					7,2340
3681802	Ø18 x H1/2" x Ø18					9,1843
3681203	Ø12 x H3/4" x Ø12					9,6052
3681403	Ø14 x H3/4" x Ø14					9,6052
3681503	Ø15 x H3/4" x Ø15					9,6052
3681603	Ø16 x H3/4" x Ø16					9,6052
3681803	Ø18 x H3/4" x Ø18					10,2556

- TAPÓN PARA BICONO
- BOUCHON MÂLE POUR BICONE · HEXAGONAL FLANGED PLUG FOR BICONE
- ЗАГЛУШКА ШЕСТИГРАННАЯ (КОЛУС) · ZAŚLEPKA

369



CODE	↔	Barcode	⊘	□	⊞	€
3690010	Ø10					2,9307
3690012	Ø12					2,9307
3690014	Ø14					3,2736
3690015	Ø15					3,2736
3690016	Ø16			500		3,2736
3690018	Ø18					3,9428
3690022	Ø22					4,8741



Racores de compresión para tubo de cobre
 Raccords à compression pour tube de cuivre · Compression fittings for copper tube
 Компрессионные фиттинги для медной трубы · Złączki skręcane do rur miedzianych

345

· TUERCA PARA BICONO
 · ÉCROU POUR BICONE · NUT FOR BICONE · ГАЙКА ШЕСТИГРАННАЯ (КОНУС) · NAKRĘTKA



CODE	↔	Barcode	⊖	□	⊞	€
3450010	Ø10 - 3/8"					1,1136
3450012	Ø12 - 3/8"					1,0193
3450212	Ø12 - 1/2"					1,2874
3450014	Ø14 - 1/2"					1,3334
3450015	Ø15 - 1/2"					1,2874
3450016	Ø16 - 1/2"					1,2538
3450018	Ø18 - M24x1,5					1,3740
3450022	Ø22 - M28x1,5					1,8992

346

· BICONO
 · BICONE · BICONE · КОНУС · PIERŚCIEŃ



CODE	↔	Barcode	⊖	□	⊞	€
3460010	Ø10					0,3955
3460012	Ø12					0,3955
3460014	Ø14					0,4920
3460015	Ø15					0,5155
3460016	Ø16					0,5155
3460018	Ø18					0,6857
3460022	Ø22					0,9911

AREAS DE APLICACIÓN

Se utiliza principalmente en sistemas de distribución de agua caliente y fría, en las instalaciones de calefacción de radiadores, para la distribución de combustibles líquidos, gaseosos, gasóleos, aceites pesados y para el desagüe sanitario de agua.
TUBERÍA. - Múltiples ventajas en el uso de tuberías de cobre

- Resistencia a la abrasión. Pérdida de carga baja debido a una excelente homogeneidad de la superficie.
- Alta conductividad térmica.
- Alta resistencia a los agentes atmosféricos.
- No se deforma.
- Dimensiones reducidas (para un mismo recorrido de tubería, la tubería de cobre tiene un menor diámetro exterior).
- Ningún efecto de memoria y en consecuencia no retracción.
- Altamente reciclable.
- No tóxico, por lo tanto, excelente para el transporte de agua potable.

TUBERÍA. - Normas y condiciones de uso

UNE-EN 1254 – 2
 "Cobre y aleaciones de cobre" – Accesorios de compresión para tuberías de cobre.

UNE-EN 1057 : 2007
 "Cobre y aleaciones de cobre" - Tubos redondos de cobre, sin soldadura, para agua y gas en aplicaciones sanitarias y de calefacción.

ROSCAS. - Normas y condiciones de uso ISO 228 DIN 259 Rosca gas Whitworth de la British Standard Pipe B.S.P para roscas

Ø Tubería	Rosca	Giro de apriete (+ ¼)
10	G 3/8"	1/2 - 3/4
12		
14		
15	G 1/2"	
16		
18		
22	M24x1,5	
	M28x1,5	

SISTEMA. - Instrucciones de montaje

- Foto nº 1: Cortar la tubería perpendicularmente a su eje mediante una herramienta apropiada y eliminar cualquier posible rebaba.
- Foto nº 2: Insertar las piezas en la tubería, como se muestra en la imagen.
- Foto nº 3: Insertar el tubo en el cuerpo empujando las piezas contra el mismo cuerpo.
- Foto nº 4: Apretar la tuerca a mano hasta llegar al cuerpo. A continuación, apretar la tuerca mediante una herramienta apropiada. Aplicar los giros de apriete según la tabla anterior.

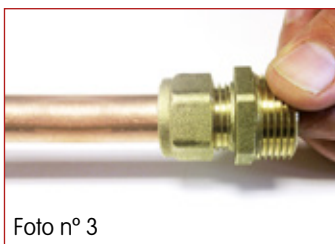
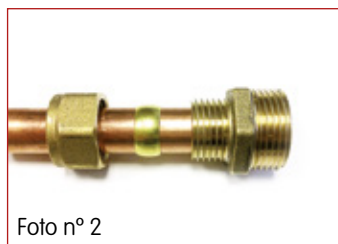
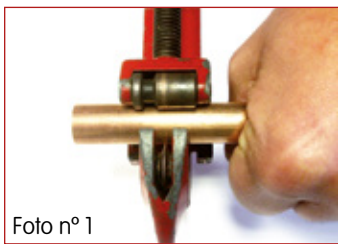

RACORES. - Producción y materiales

Todos los racores son fabricados en n mediante los siguientes procesos:

- Estampación en caliente y mecanización en máquinas transfer
- A partir de barra y mecanización en tornos multicabezal CNC

Fabricación	Normativa y material	Composición química
Estampación	UNE-EN 12165 CW617N-CuZn40Pb2	Cu57-59 Pb1.6-2.2 Sn<0.3 Fe<0.1 Ni<0.3 Al<0.05 Zn Diff.
Barra	UNE-EN 12164 CW614N-CuZn39Pb3	Cu57-59 Pb2.3-3.5 Sn<0.3 Fe<0.1 Ni<0.3 Al<0.05 Zn Diff.

CONDICIONES DE USO

Dimensión Tubo	Presión en (Bar)	
	a 30°C	a 120°C
Ø10 – Ø22	16	5





Racores de compresión para tubo de cobre
 Raccords à compression pour tube de cuivre · Compression fittings for copper tube
 Компрессионные фитинги для медной трубы · Złączki skręcane do rur miedzianych

AREAS OF APPLICATION

Its main application is in hot and cold water distribution systems in radiating heating installations, for the distribution of liquid and gaseous fuels, diesel, heavy oils and water drainage.

PIPE. - Multiple advantages in the use of copper pipes

- Resistance to abrasion. Low load loss due to the good smooth surface.
- High thermal conductivity.
- High resistance to atmospheric agents.
- Non deformation.
- Compact dimensions (with the same piping run, the copper pipe has a smaller outside diameter).
- No memory effect and therefore no spring back.
- Highly recyclable.
- Non-toxic, therefore perfect for transporting drinking water.

PIPE. - Regulations and conditions of use

UNE-EN 1254 – 2
 "Copper and copper alloys" - Compression fittings for copper pipes.

UNE-EN 1057 : 2007
 "Copper and copper alloys" - Round copper weldless pipes for water and gas in sanitary and heating applications.

THREADS. - Standards and conditions of use

ISO 228 DIN 259 Threaded Whitworth gas of BSP British Standard Pipe thread

Ø Pipe	Coupling Thread	Tightening turns (+ ¼)
10	G 3/8"	1/2 - 3/4
12		
14	G 1/2"	
15		
16		
18	M24x1.5	
22	M28x1.5	

SISTEM. - Installation instructions

- Photo nº 1: Cut the pipe perpendicularly to its axis using an appropriate tool and remove any possible flashes.
- Photo nº 2: Insert the parts in the pipe, as shown in the picture.
- Photo nº 3: Insert the pipe into the body pushing the parts against the same body.
- Photo nº 4: Tighten the nut by hand until it clumps. Then tighten the nut using an appropriate tool.

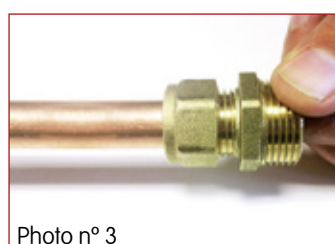

FITTINGS. - Production and materials

All fittings are manufactured in brass through the following methods:

- Hot stamping and mechanisation in transfer machines
- From bar and mechanisation in multiple spindle CNC

Method	Norm and material	Chemical composition
Hot Stamping	UNE-EN 12165 CW617N-CuZn40Pb2	Cu57-59 Pb1.6-2.2 Sn<0.3 Fe<0.1 Ni<0.3 Al<0.05 Zn Diff.
Bar	UNE-EN 12164 CW614N-CuZn39Pb3	Cu57-59 Pb2.3-3.5 Sn<0.3 Fe<0.1 Ni<0.3 Al<0.05 Zn Diff.

TERMS OF USE

Pipe dimension	Pressure (Bar)	
	at 30°C	at 120°C
Ø10 – Ø22	16	5



- UNIÓN TUBO INSERTO FIJO
- UNION TUBE TUBE ADAPTATEUR FIXE · STRAIGHT UNION TUBE TUBE FIXED INSERT
- СОЕДИНИТЕЛЬ ПРЯМОЙ НЕРАЗЪЕМНЫЙ · ZŁĄCZKA PROSTA RURA/RURA

150



CODE	↔		○ □ ▣	€	
· NÍQUEL · Niquel · Nickel · Никелированный · Nikiel					
1501600-N	16 x 2 mm	8431977203743	10	250	7,3200
1502000-N	20 x 2 mm	8431977202463	10	150	12,1696



- UNIÓN TUBO MACHO INSERTO FIJO
- UNION TUBE MÂLE ADAPTATEUR FIXE · STRAIGHT UNION TUBE MALE FIXED INSERT
- СОЕДИНИТЕЛЬ ПРЯМОЙ НЕРАЗЪЕМНЫЙ С ПЕРЕХОДОМ НА НР · ZŁĄCZKA PROSTA GZ/RURA

152



CODE	↔		○ □ ▣	€	
· NÍQUEL · Niquel · Nickel · Никелированный · Nikiel					
1521602-N	M 1/2" x 16 x 2 mm	8431977203750	10	250	4,6415
1521603-N	M 3/4" x 16 x 2 mm	8431977203767	10	250	5,3079
1522002-N	M 1/2" x 20 x 2 mm	8431977204320	10	200	5,9508
1522003-N	M 3/4" x 20 x 2 mm	8431977202470	10	200	6,9859



- UNIÓN TUBO HEMBRA INSERTO FIJO
- UNION TUBE FEMELLE ADAPTATEUR FIXE · STRAIGHT UNION TUBE FEMALE FIXED INSERT
- СОЕДИНИТЕЛЬ ПРЯМОЙ НЕРАЗЪЕМНЫЙ С ПЕРЕХОДОМ НА ВР · ZŁĄCZKA PROSTA GW/RURA

154



CODE	↔		○ □ ▣	€	
· NÍQUEL · Niquel · Nickel · Никелированный · Nikiel					
1541602-N	H 1/2" x 16 x 2 mm	8431977203774	10	250	4,5391
1541603-N	H 3/4" x 16 x 2 mm	8431977203781	10	250	5,4796
1542002-N	H 1/2" x 20 x 2 mm	8431977202487	10	200	7,3265
1542003-N	H 3/4" x 20 x 2 mm	8431977202494	10	150	7,5495



- CODO TUBO TUBO INSERTO FIJO
- COUDE TUBE TUBE ADAPTATEUR FIXE · ELBOW TUBE TUBE FIXED INSERT
- УГОЛОК НЕРАЗЪЕМНЫЙ · KOLANO RURA/RURA

156



CODE	↔		○ □ ▣	€	
· NÍQUEL · Niquel · Nickel · Никелированный · Nikiel					
1561600-N	16 x 16 x 2 mm	8431977203842	10	200	8,1253
1562000-N	20 x 20 x 2 mm	8431977208687	10	150	10,6314

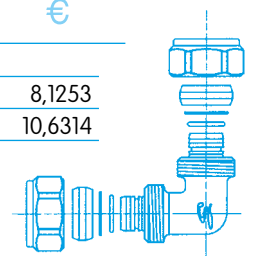

158

- CODO TUBO MACHO INSERTO FIJO
- COUDE TUBE MÂLE ADAPTATEUR FIXE · ELBOW TUBE MALE FIXED INSERT
- УГОЛОК НЕРАЗЪЕМНЫЙ С ПЕРЕХОДОМ НА НР · KOLANO GZ/RURA



CODE	↔	Barcode	⊗	□	⊞	€
· NÍQUEL · Niquel · Nickel · Никелированный · Nikiel						
1581602-N	M 1/2" x 16 x 2 mm	8431977203859	10	200	5,6606	
1581603-N	M 3/4" x 16 x 2 mm	8431977203866	10	200	6,2396	
1582002-N	M 1/2" x 20 x 2 mm	8431977207987	10	150	7,2384	
1582003-N	M 3/4" x 20 x 2 mm	8431977207963	10	120	8,8246	

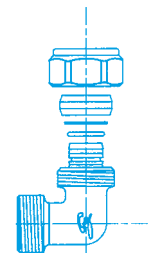

160

- CODO TUBO HEMBRA INSERTO FIJO
- COUDE TUBE FEMELLE ADAPTATEUR FIXE · ELBOW TUBE FEMALE FIXED INSERT
- УГОЛОК НЕРАЗЪЕМНЫЙ С ПЕРЕХОДОМ НА ВР · KOLANO GW/RURA



CODE	↔	Barcode	⊗	□	⊞	€
· NÍQUEL · Niquel · Nickel · Никелированный · Nikiel						
1601602-N	H 1/2" x 16 x 2 mm	8431977203873	10	200	6,6276	
1601603-N	H 3/4" x 16 x 2 mm	8431977203880	10	150	7,5097	
1602002-N	H 1/2" x 20 x 2 mm	8431977207994	10	120	11,2317	
1602003-N	H 3/4" x 20 x 2 mm	8431977207970	10	100	12,3225	

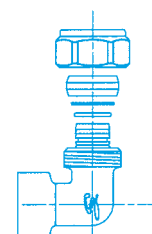

162

- CODO MURAL TUBO HEMBRA INSERTO FIJO
- APPLIQUE TUBE FEMELLE ADAPTATEUR FIXE · WALL PLATE ELBOW TUBE FEMALE FIXED INSERT
- УГОЛОК НЕРАЗЪЕМНЫЙ С КРЕПЛЕНИЕМ · KOLANO Z ŁAPAMI GW/RURA



CODE	↔	Barcode	⊗	□	⊞	€
· NÍQUEL · Niquel · Nickel · Никелированный · Nikiel						
1621602-N	H 1/2" x 16 x 2 mm	8431977203897	10	150	6,5207	



164

- TE TUBO TUBO INSERTO FIJO
- TE TUBE TUBE ADAPTATEUR FIXE · TEE TUBE TUBE FIXED INSERT
- ТРОЙНИК НЕРАЗЪЕМНЫЙ · TRÓJNIK RURA/RURA/RURA



CODE	↔	Barcode	⊗	□	⊞	€
· NÍQUEL · Niquel · Nickel · Никелированный · Nikiel						
1641600-N	16 x 16 x 16 x 2 mm	8431977203798	10	120	10,7703	
1642000-N	20 x 20 x 20 x 2 mm	8431977208694	10	100	19,9840	

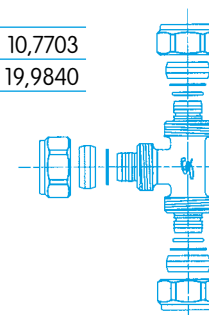

166

- TE TUBO MACHO INSERTO FIJO
- TE TUBE MÂLE ADAPTATEUR FIXE · TEE TUBE MALE FIXED INSERT
- ТРОЙНИК НЕРАЗЪЕМНЫЙ С ПЕРЕХОДОМ НА НР · TRÓJNIK RURA/GZ/RURA



CODE	↔	Barcode	⊖	□	⊞	€
· NÍQUEL · Niquel · Nickel · Никелированный · Nikiel						
1661602-N	16 x M 1/2" x 16 x 2 mm	8431977203804	10	150	8,3587	
1661603-N	16 x M 3/4" x 16 x 2 mm	8431977203811	10	150	8,9093	
1662002-N	20 x M 1/2" x 20 x 2 mm	8431977202500	10	100	13,0545	
1662003-N	20 x M 3/4" x 20 x 2 mm	8431977209387	10	80	13,2449	

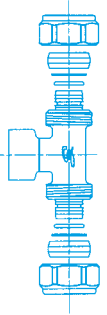

168

- TE TUBO HEMBRA INSERTO FIJO
- TE TUBE FEMELLE ADAPTATEUR FIXE · TEE TUBE FEMALE FIXED INSERT
- ТРОЙНИК НЕРАЗЪЕМНЫЙ С ПЕРЕХОДОМ НА ВР · TRÓJNIK RURA/GW/RURA



CODE	↔	Barcode	⊖	□	⊞	€
· NÍQUEL · Niquel · Nickel · Никелированный · Nikiel						
1681602-N	16 x H 1/2" x 16 x 2 mm	8431977203828	10	150	8,8046	
1681603-N	16 x H 3/4" x 16 x 2 mm	8431977203835	10	120	9,4636	
1682002-N	20 x H 1/2" x 20 x 2 mm	8431977208724	10	100	14,8845	
1682003-N	20 x H 3/4" x 20 x 2 mm	8431977208731	10	80	14,7578	

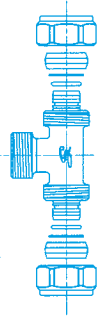

169

- TAPÓN MACHO RECUPERABLE
- BOUCHON MÂLE RÉUTILISABLE · REUSABLE HEXAGONAL FLANGED PLUG
- ЗАГЛУШКА · KOREK



CODE	↔	Barcode	⊖	□	⊞	€
· NÍQUEL · Niquel · Nickel · Никелированный · Nikiel						
1691602-N	M 1/2" x 16 x 2 mm	8431977204863	10	300	4,3225	
1691803-N	M 3/4" x 18 x 2 mm	8431977205389	10		7,4262	
1692003-N	M 3/4" x 20 x 2 mm	8431977205396	10		6,8400	

170

- UNIÓN TUBO INSERTO DESMONTABLE
- UNION TUBE TUBE ADAPTATEUR DÉTACHABLE · STRAIGHT UNION TUBE TUBE DETACHABLE INSERT
- СОЕДИНИТЕЛЬ РАЗЪЕМНЫЙ ПРЯМОЙ · ZŁĄCZKA PROSTA RURA/RURA - WKŁADKA WYJMOWALNA



CODE	↔	Barcode	⊖	□	⊞	€
1701600	16 x 2 mm					8,0068

172

- UNIÓN TUBO MACHO INSERTO DESMONTABLE
- UNION TUBE MÂLE ADAPTATEUR DÉTACHABLE · STRAIGHT UNION TUBE MALE DETACHABLE INSERT
- СОЕДИНИТЕЛЬ РАЗЪЕМНЫЙ С ПЕРЕХОДОМ НА НР · ZŁĄCZKA PROSTA GZ/RURA - WKŁADKA WYJMOWALNA



CODE	↔	Barcode	⊖	□	⊞	€
1721602	M 1/2" x 16 x 2 mm					4,8670
1722002	M 1/2" x 20 x 2 mm					5,8971
1722003	M 3/4" x 20 x 2 mm					6,5211

178

- CODO TUBO MACHO INSERTO DESMONTABLE
- COUDE TUBE MÂLE ADAPTATEUR DÉTACHABLE · ELBOW TUBE MALE DETACHABLE INSERT
- УГОЛОК РАЗЪЕМНЫЙ С ПЕРЕХОДОМ НА HP · KOLANO GZ/RURA - WKŁADKA WYJMOWALNA



CODE	↔	Barcode	⊖	□	⊞	€
1781602	M 1/2" x 16 x 2 mm					10,6816
1782003	M 3/4" x 20 x 2 mm					12,0050

182

- CODO PLATINA TUBO INSERTO DESMONTABLE
- COUDE PLATINE TUBE ADAPTATEUR DÉTACHABLE · PLATE ELBOW TUBE DETACHABLE INSERT
- УГОЛОК РАЗЪЕМНЫЙ С НАКЛАДКОЙ · KOLANO Z PODSTAWĄ - WKŁADKA WYJMOWALNA



CODE	↔	Barcode	⊖	□	⊞	€
1821602	H 1/2" x 16 x 2 mm					8,8802
1822002	H 1/2" x 20 x 2 mm					10,9857

85

- EUROCONO INSERTO DESMONTABLE
- EUROCONE AVEC ADAPTEUR DÉTACHABLE · EUROCONE FOR DETACHABLE INSERT
- ЕВРОКОНУС · ZŁĄCZKA EUROKONUS



CODE	↔	Barcode	⊖	□	⊞	€
· NÍQUEL · Niquel · Nickel · Никелированный · Nikiel						
085162-N	1/2" x 16 x 2 D.Asiento 14					4,1578
085163-N	3/4" x 16 x 2 D.Asiento 18					5,8716
085183-N	3/4" x 18 x 2 D.Asiento 18					6,3864
085203-N	3/4" x 20 x 2 D.Asiento 18					6,3864



AMARILLO · Jaune · Yellow · Желтый · Żółta - REF. 170 - 182						
0851162	1/2" x 16 x 2 D.Asiento 16					3,3649
0851203	3/4" x 20 x 2 D.Asiento 18					5,6057
08512532	32 x 25 x 2,3 D.Asiento 25					14,8385
08513241	41 x 32 x 2,9 D.Asiento 32					22,8408

84

- ADAPTADOR ROSCA
- ADAPTEUR DE FILET · THREAD ADAPTOR
- ПЕРЕХОДНИК РЕЗЬБОВОЙ · ADAPTER DO GWINTU







CODE	↔	Barcode	⊖	□	⊞	€
0842405	1.1/4" x 40 x 4					aconsultar
0842506	1.1/2" x 50 x 4,5					aconsultar
0842637	2" x 63 x 6					aconsultar



401

- UNIÓN TUBO MACHO
- UNION TUBE MÂLE · TUBE MALE UNION
- СОЕДИНЕНИЕ ПРЯМОЕ HP · ZŁACZKA PROSTA GZ/RURA



CODE	↔					€
4011602	M1/2" x 16 mm					6,3623
4012002	M1/2" x 20 mm					6,4145
4012503	M3/4" x 25 mm					8,9656

Sobime



Cod.	Descripción - Description	Pag.
1	Grifo boca riego vertical con racor Barcelona o racor manguera	53
2	Grifo boca riego horizontal con racor Barcelona o racor manguera	53
3	Grifo paso rosca con montura 1/2"	53
4	Racor "Y"	35
6	Grifo codo presión	55
7	Grifo codo presión con racor manguera	55
8	Manguito hexagonal	31
12	Grifo fuente pública a rosca	56
13	Alargo con tuerca loca	15
14	Tuerca con precinto para cono contador	26
15	Racor contador	27
16	Alargo grifo	61
17	Montura grifo presión	59
22	Racor dos piezas para manguera	41
23	Racor Barcelona enchufe rápido	42
24	Lanza graduable tres efectos para manguera	43
25	Pitón riego para manguera	43
27	Colzada para grifo boca riego tipo Madrid	44
28	Te empalme manguera	43
29	Empalme unión para manguera	43
30	Entronque macho para manguera	41
31	Racor para depósito de uralita	29
33	Enlace contra rosca MM	18
33R	Enlace contra rosca reducido MM	19
34	Válvula descarga váter cuatro guías reforzada con plomo	59
35	Entronque hembra para manguera	41
38	Cruz macho	35
40	Fuente surtidor	56
41	Bebedero tolva para cerdos	52
42	Bebedero automático para cerdos	52
43	Bebedero automático para cerdas de cría	52
44	Tapón hembra	25
45	Grifo lavadora doble uso	57
46	Grifo lavadora un uso	57
47	Flotador silencioso	59
48	Flotador olleta	59
49	Tuerca corredera con valona	26
50	Grifo lavabo modelo "Hogar"	57
51	Grifo fregadera	58
52	Válvula de pie	48
53	Válvula de retención HH	48
53MH	Válvula de retención MH	49
54	Válvula de retención MM	49
55	Grifo fregadera modelo "Río"	58
56	Válvula antirretorno MH	49
58	Codo tres bocas	33
59	Cruz hembra	34
59R	Cruz hembra reducida	34
60	Llave de regulación escuadra larga	58
61	Conexión malla acero inoxidable	62
62	Racor Marsella	20
62R	Racor Marsella reducido	21
63	Alargo cilíndrico MH con aletas	22
64	Curva HH	34
65	Manguito reducido HH	30
66	Manguito HH	30
67	Codo HH	21
67MH	Codo MH	32
67MHR	Codo reducido MH	33
67U	Curva MH	34
68	Te hembra	36
68R	Te hembra reducida	36
69	Tapón macho	24
70	Lanza manguera tres efectos	42
71	Grifo esfera codo manguera	55
72	Codo con tuerca loca	15
72MH	Codo macho con tuerca loca	16
73	Conjunto monobloc recto níquelado	63
73U	Conjunto monobloc curvo níquelado	63
74	Collarín	45
75	Aro reducido MH con valona hexagonal	23
76	Tapón macho sin valona	24
77	Anillo roscado	23
79	Junta plana Belpa	39
81	Tuerca unión tres piezas HH	37
81MH	Tuerca unión tres piezas MH	38
81MM	Tuerca unión tres piezas MM	38
83	Racor unión 2 piezas HH junta plana	40
83MH	Racor unión 2 piezas MH junta plana	40
86	Colector HH	46
87	Colector MH	47
88	Válvula esfera paso total	50
89	Grifo barril mini	54
90	Grifo para barril	54
91	Codo mural HH	33
93	Codo reducido HH	31
94	Codo MM	32
95	Te MMM	37



Cod.	Descripción - Description	Pag.
96	Te cinco vías	48
97	Juego de florones y excéntricas	63
98	Te macho con tuerca loca	17
99	Junta plana	17
101	Filtro latón tipo "Y" con tamiz inox	50
102	Válvula de retención clapeta caucho	50
103	Válvula de fondo filtro latón	50
104	Válvula de retención HH dos salidas	49
105	Válvula retención panel solar	51
131	Racor náutico pasacascos	28
441	Tuerca	25
481	Flotador varilla roscada asiento inoxidable	59
482	Flotador varilla deslizante asiento inoxidable	50
561	Accesorios para radiadores de aluminio	63
861	Te para terminal colector	46
970	Codo unión 3 piezas MH	39
4813	Boya latón esférica para flotador varilla roscada	60
4814	Boya plástico expandido esférica para flotador varilla roscada	60
4815	Boya plástico expandido plana flotador varilla roscada / deslizante	60
4816	Boya porexpan	61
4826	Boya cobre plana para flotador varilla deslizante	61
9095	Caño para grifo baño/ducha con inversor	69
9901	Conjunto placa-codo	61
99040	Columna fundida para batería baño	64
99041	Columna estampada con florón para batería baño	65
99042	Placa para grifo	66
99043	Columna excéntrica para batería baño	67
99044	Excéntrica plana	67
99045	Contra codo con florón	68
99046	Codo escuadra	69
ACCESORIOS PARA TUBERÍA DE COBRE		
90 GCu	Codo hembra	70
92 GCu	Codo macho	70
98 GCu	Codo unión macho	71
130 GCu	Te hembra	71
180 Cu	Cruz soldar	71
243 GCu	Entronque macho	72
270 GCu	Enlace hembra	73
301 Cu	Tapón hembra	73
340 Cu	Empalme unión 3 piezas soldar	73
340 GCu	Empalme unión 3 piezas hembra soldar	74
341 GCu	Empalme unión 3 piezas macho soldar	74
359 GLCu	Racor dos piezas casquillo largo cobre soldar	76
2A GCu	Racor dos piezas curvo soldar	75
471 GCu	Codo mural base triangular	75
472 GCu	Codo mural	74
1003 (85 Cu)	Puente	77
RACORES DE COMPRESIÓN PARA TUBO DE COBRE		
345	Tuerca para bicono	82
346	Bicono	82
350	Unión tubo - tubo para bicono	78
350R	Unión tubo - tubo reducido para bicono	78
352	Unión tubo macho para bicono	78
354	Unión tubo hembra para bicono	79
356	Codo tubo - tubo para bicono	79
356R	Codo tubo - tubo reducido para bicono	79
358	Codo tubo macho para bicono	80
360	Codo tubo hembra para bicono	80
362	Codo mural tubo hembra para bicono	80
364	Te tubo para bicono	81
368	Te tubo hembra para bicono	81
369	Tapón para bicono	81
RACORES PARA TUBO PEX Y MULTICAPA		
150	Unión tubo con inserto fijo	85
152	Unión tubo macho con inserto fijo	85
154	Unión tubo hembra con inserto fijo	85
156	Codo tubo tubo con inserto fijo	85
158	Codo tubo macho con inserto fijo	86
160	Codo tubo hembra con inserto fijo	86
162	Codo mural tubo hembra con inserto fijo	86
164	Te tubo tubo con inserto fijo	86
166	Te tubo macho con inserto fijo	87
168	Te tubo hembra con inserto fijo	87
169	Tapón macho recuperable	87
170	Unión tubo inserto desmontable	87
172	Unión tubo macho con inserto desmontable	87
178	Codo tubo macho con inserto desmontable	88
182	Codo platina tubo con inserto desmontable	88
84	Adaptador rosca	88
85	Eurocono inserto desmontable	88
RACORES DE LATÓN PARA TUBO DE POLIETILENO		
401	Unión tubo macho	89

El Cliente acepta las siguientes condiciones generales de venta.

PEDIDO

Los pedidos son aceptados siempre que no exista incompatibilidad con la política comercial de SOBIME S.A. De producirse alguna, se comunicará al cliente para su corrección.

En ningún caso se admiten pedidos con importe neto inferior a 600,00 Euros + IVA.

En ningún caso, se considerará como condiciones de venta de SOBIME, S.A. un pedido valorado por el cliente.

Las cantidades pedidas se ajustarán automáticamente a la cantidad mínima de venta superior.

CANCELACIÓN DE PEDIDO

Un pedido puede ser anulado por escrito en las 48 horas siguientes de la recepción del mismo excepto en los siguientes casos:

- La expedición de material se ha efectuado antes de la recepción de la orden de anulación de pedido.
- El pedido se refiere a un producto de fabricación especial y su producción ya se ha iniciado.

PLAZO DE ENTREGA

El plazo de entrega es el habitual en el tipo de mercancía a servir o la fecha indicada en el pedido, pudiéndose producir variaciones por causas ajenas a la voluntad del fabricante.

PORTES

La mercancía viaja a portes pagados cuando el importe neto de la factura es superior a 600,00 Euros para territorio nacional peninsular y Baleares, o 2.000,00 Euros para Islas Canarias. Entregas en Ceuta y Melilla a convenir. Para importes inferiores, los gastos de transporten corren a cargo del cliente.

Cuando el porte de la mercancía a enviar sea tarifado por volumen en lugar de por peso, el párrafo anterior queda anulado y el importe neto mínimo de factura se establecerá según cada caso en particular.

Los envíos a portes pagados se efectúan por la agencia y modalidad que el fabricante tenga contratadas. El Cliente se hace cargo del transporte cuando solicite otra agencia o forma de transporte.

SEGURO

La mercancía viaja siempre a cuenta y riesgo del comprador, aún cuando lo haga a portes pagados.

PAGO

El importe de la mercancía, salvo casos particulares, se abona máximo a 60 días fecha factura mediante giro bancario.

RECLAMACIÓN

Toda reclamación referente a la cantidad o calidad de la mercancía recibida debe efectuarse en un plazo máximo de 3 días desde la fecha de recepción. De lo contrario, dicha reclamación queda automáticamente sin efecto.

DEVOLUCIÓN

La devolución de material solo puede realizarse previa autorización por escrito del fabricante y a través de la agencia de transporte indicada por el mismo. La sustitución o abono de dicha

mercancía está sujeta a la supervisión y dictamen del departamento técnico del fabricante.

Toda devolución debe ir acompañada obligatoriamente de un detalle de contenido indicando referencia de artículo del fabricante, cantidad por referencia, nº de factura de compra por artículo, motivo de la devolución y si se solicita abono o sustitución. La ausencia de este documento anula instantáneamente cualquier solicitud al respecto.

No se admitirá ninguna devolución de material pasados 30 días desde la fecha de la factura.

No se aceptará ninguna devolución de mercancía que pueda repararse con recambios originales.

Solamente se aceptará devolución de material comprado en el año en curso y en caso de aceptación, se abonará con una depreciación del 15%.

PRECIOS

La tarifa recogida en este catálogo puede ser modificada a consideración de SOBIME S.A., con aviso a todas las partes implicadas. La facturación se realiza de acuerdo con los precios en vigor el día de expedición del material.

DISEÑO Y EMBALAJE

Es potestad del fabricante la modificación del diseño y el acondicionamiento de sus productos, sin previo aviso, sin que el comprador pueda demandar cualquier tipo de perjuicio. Todos los datos impresos en catálogos, folletos, listas o cualquier otro material publicitario sobre cualquier artículo son a título informativo, por lo que el cliente no podrá acogerse a ellos en caso de posibles quejas por disconformidad o diferencia con los productos suministrados.

GARANTÍA

Los productos de SOBIME S.A. están garantizados ante eventuales defectos derivados del proceso de fabricación durante 2 años según la Ley de Garantías.

En ningún caso la garantía cubre daños ocasionados por una instalación incorrecta, trato inadecuado o utilización impropia.

RESERVA DE DOMINIO

SOBIME S.A. se reserva el derecho de acceso al material suministrado siempre y cuando el Cliente no abone las facturas en la fecha de vencimiento indicada en las mismas. El impago de cualquier importe por parte del comprador, permite al vendedor, sin ningún tipo de formalidad anterior, la recuperación de la mercancía.

JURISDICCIÓN

En el caso de una posible reclamación judicial, las partes convienen que los tribunales de Barcelona son los únicos competentes para la resolución de los litigios derivados de las ventas realizadas por SOBIME, S.A.

ACEPTACIÓN DE CONDICIONES

Todo pedido recibido implica la aceptación formal de estas condiciones.

The customer agrees to the following sales conditions.

ORDER

Orders can be accepted as long as there is no incompatibility with the sales policy of SOBIME S.A. If this were to occur this would be communicated to the customer for correction.

In no case can orders below the amount agreed in Euros be accepted.

CANCELLATION OF ORDER

An order may be cancelled in writing 48 hours after its reception except in the following cases:

- the material has been sent previous to reception of order cancellation
- the order requires a special production process and production has already started.

DELIVERY TIME

Delivery of goods is the normal time for this type of merchandise or the date indicated on the order taking into consideration that the date can vary due to causes beyond the manufacturer's control.

TRANSPORT

The merchandise is sent free of charge when the net amount of the invoice is above the amount agreed in Euros. For amounts below this the transport costs are to be paid by the client.

When the goods are sent by volume and not weight, the previous paragraph remains cancelled and the minimum net amount of the invoice will be established according to each case.

The deliveries paid by the manufacturer will be carried out by the agency and means agreed with the transport company contracted by the manufacturer. If the Client requires another transport agency or form of transport they will be responsible for transport fees.

INSURANCE

The goods travel at the risk and expense of the customer even if the goods are sent free of charge.

PAYMENT

The total amount of the merchandise is to be paid 60 days maximum from date of invoice by means of bank transfer.

COMPLAINTS

All complaints referring to the quantity or quality of the merchandise must be received within 3 days from date of reception. If not the complaint will remain automatically cancelled.

RETURN OF MATERIAL

The return of the material can only take place upon previous written authorization of the manufacturer and by its designated transport agency. The substitution or credit note for this merchandise is subject to the supervision and decision of the manufacturer's technical department.

The return of all material must be accompanied by a packing list indicating the manufacturer's article reference, quantity per reference, invoice number for each article and reason for the

return specifying if they request a credit note or substitution. The absence of this document automatically cancels any request.

No material can be returned after 30 days after the date of invoice.

No return of material will be accepted if the material can be repaired with original spare parts.

The return of material will only be accepted for material purchased in the year in progress and in the case of acceptance it shall be paid with a reduction of 15% from the original price.

PRICES

SOBIME S.A. reserves the right to modify prices contained in this catalogue upon communication with the customer. The invoice will be issued according to the prices valid on the day the material is sent.

DESIGN & PACKAGING

The manufacturer reserves the right to modify the design and packaging of the products without prior notice and the customer has no right to claim any type of prejudice. All information printed in catalogues, brochures, lists or any other advertising material referring to any article is merely informative and the customer cannot refer to this in case of possible complaints or differences with the products supplied.

GUARANTEE

SOBIME S.A. products are guaranteed against defects resulting from the manufacturing process for 2 years according the law of Guarantees. In no circumstances does the guarantee cover damage resulting from incorrect installation, improper treatment or misuse.

RESERVE OF DOMAIN

SOBIME S.A. reserves the right to access the material supplied provided that the client does not pay the invoices on the expiry date indicated. The non payment of any amount by the purchaser authorises the seller to recover the material with no prior formalities.

DISPUTES

In the case of a possible legal claim the parties agree that the Courts of Barcelona are the only legal authorities for the resolution of disputes arising from sales by SOBIME S.A.

ACCEPTANCE OF CONDITIONS

All order received implies the formal acceptance of these conditions.







SOBIME S.A.

C. Sant Josep 123. Pg. Ind. El Pla
08980 Sant Feliu de Llobregat (Barcelona) Spain

Dirección postal - Post address:

SOBIME S.A.

Apartado de Correos 1449

08980 Sant Feliu de Llobregat (Barcelona) Spain

Tel. +34 93 666 06 89 / 93 666 12 96

Fax. +34 93 666 06 00

www.sobime.com
sobime@sobime.com

ISO 9001

BUREAU VERITAS
Certification

