



SUNFER



Índice



Nuestro compromiso

Marcado
ES19/86524



CERTIFIED



ES13/13899



ES22/211172

Con más de dos décadas de experiencia pionera en el mercado fotovoltaico, **Sunfer Energy** se define como un referente en diseño, cálculo y fabricación de estructuras para la instalación óptima de placas solares. Como firma española de renombre, contamos con un equipo de más de 150 profesionales comprometidos, respaldados por una larga trayectoria de innovación y excelencia en cada paso del proceso.

Nuestras instalaciones, ubicadas en Valencia y abarcando 30.000 m², son el epicentro donde convergen la creatividad y la eficiencia. Es desde aquí, donde se lleva a cabo todos los procesos de diseño, fabricación y certificación que respaldan la calidad de nuestras estructuras.

La presencia internacional de productos Sunfer se extiende a más de 30 países, consolidando nuestra reputación global y destacando la confianza depositada en nuestros productos a nivel mundial.

Contamos con la certificación de mercado CE y las normativas ISO 9001 y ISO 14001, garantizando la excelencia en el diseño y la fabricación de cada estructura, además de cumplir con las rigurosas normativas como el Eurocódigo 9 y los estándares específicos de cada país de destino, como MCS en Reino Unido y ETN en Francia.



Productos y servicios

“Descubre un sistema versátil, diseñado para ofrecer una instalación rápida y sencilla, a un precio altamente competitivo y sin preocupaciones”



Configuración adaptada para proyectos eficientes y simplificados



Montaje simplificado y rápido

Los kits incluyen perfiles y accesorios premontados desde fábrica, ahorrando tiempo tanto al instalador como al cliente final. Además, todos los productos son stockables, garantizando la disponibilidad inmediata.

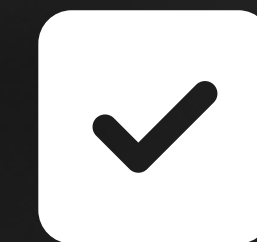

Alta durabilidad

Cada una de las piezas está diseñada para perdurar, resistiendo incluso las condiciones climáticas más adversas, asegurando una instalación sólida y fiable a lo largo del tiempo.



Agilidad y soporte

La facilidad de montaje va de la mano de nuestros productos, respaldada por documentación técnica accesible mediante códigos QR y una asistencia técnica y servicio posventa de primera categoría.



Sistema Bulk

Para proyectos personalizados de gran formato

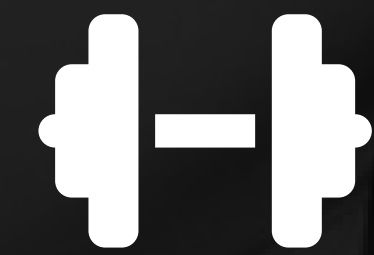

Soluciones a medida

Al igual que el Sistema Kit, todos los accesorios y perfilería se sirven premontados para poder adaptarlos a cualquier proyecto de grandes obras y poder cortar la perfilería sobrante si fuese necesario.



Ligero ahorro económico

El Sistema Bulk puede ser una buena elección por ofrecer precios más bajos por unidad, además permite un mayor control sobre la cantidad de piezas, sin comprometer la calidad ni la eficiencia.



Personalización integral

Cada proyecto se somete a un estudio personalizado a medida, asegurando que se utilice la cantidad exacta de material necesario, optimizando recursos y minimizando desperdicios.



Materiales y acabados

“Entendemos las demandas tanto del mercado residencial como de las grandes instalaciones industriales”.

Perfilería de aluminio de alta calidad

Nuestro compromiso con la excelencia nos lleva a emplear perfilería de Aluminio EN AW-6005A T6, reconocido por su resistencia y durabilidad.

Ofrecemos dos acabados distintos

Aluminio crudo y aluminio anodizado también en negro.

Protección y resistencia asegurada

El proceso de anodizado del aluminio que empleamos proporciona una capa protectora contra agentes externos.

Tornillería de acero inoxidable A2-70

Reconocida por su resistencia a la corrosión y su durabilidad en entornos desafiantes.

100% made in Spain con materiales europeos

Fabricamos íntegramente en España, utilizando materiales provenientes de Europa. De este modo, respaldamos nuestra política de calidad, al asociarnos solo con las mejores firmas de producción de aluminio, asegurando así una calidad superior de la materia prima.

Garantía estructural y anticorrosión

Ofrecemos hasta 25 años de garantía ofreciendo a nuestros clientes la mejor experiencia y los productos más confiables del mercado.



Nuestras cifras

Se manifiestan a través del esfuerzo por superar los estándares de calidad

+25

AÑOS DE EXPERIENCIA
EN EL SECTOR

+160

PROFESIONALES
COMPROMETIDOS

+30K

M² DE
INSTALACIONES

1.2K

MW INSTALADOS
CON NUESTRAS
ESTRUCTURAS EN 2023

30K

KITS
EN STOCK

1.5K

PUNTOS
DE VENTA

14K

PEDIDOS
REALIZADOS
EN 2023

+5GW

DE ESTRUCTURAS
FABRICADAS



SUNFER



Nosotros

Impulsamos la economía circular

En Sunfer Energy nos comprometemos con un futuro sostenible.

**“Cada kilovatio instalado
nos acerca a un mundo más verde”**

Nuestros productos no solo están diseñados para contribuir con la eficiencia energética, sino que también reflejan nuestro compromiso con el medio ambiente, al utilizar aluminio reciclado.



Servicio de atención posventa

Capacitación especializada y soporte integral



Formaciones a medida

Dirigidas a cualquier público, desde capacitaciones especializadas hasta jornadas específicas de producto, técnicas de instalación y training de nuestras herramientas, tanto online, presenciales en Sunfer o cualquier lugar.



Soporte continuo

Accesibilidad vía email, teléfono y Whatsapp para resolver cualquier consulta y brindar asistencia técnica en todas las fases del proyecto.



Acceso exclusivo

Nuestra plataforma de dimensionamiento está diseñada para ayudar con el estudio de proyectos y simplificar la gestión de cotización, gracias a su informe detallado del producto.

Cubierta de teja

Carril Continuo

Fijación mejorada clip

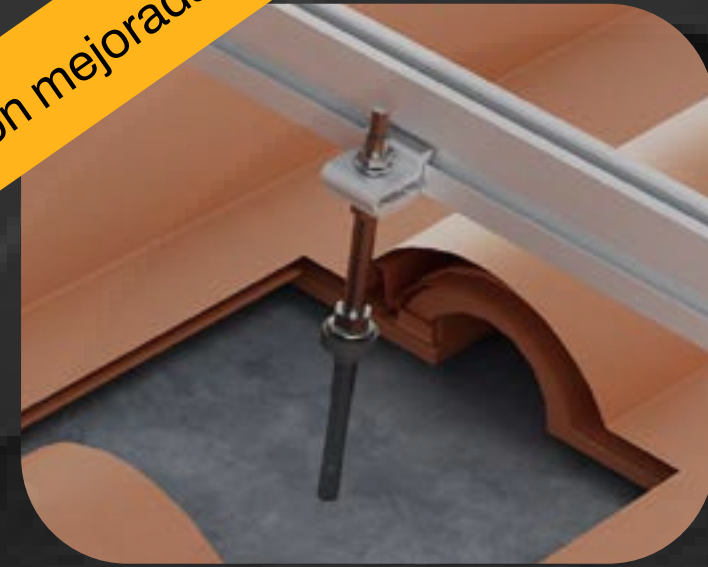

01V

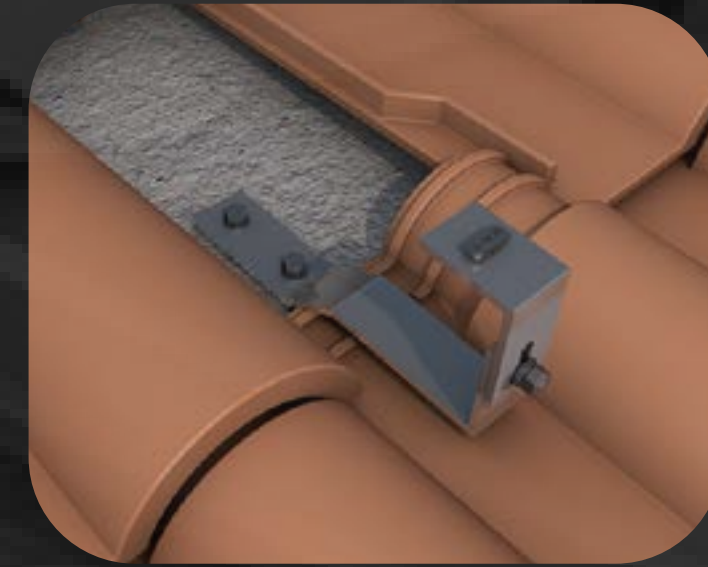

02V

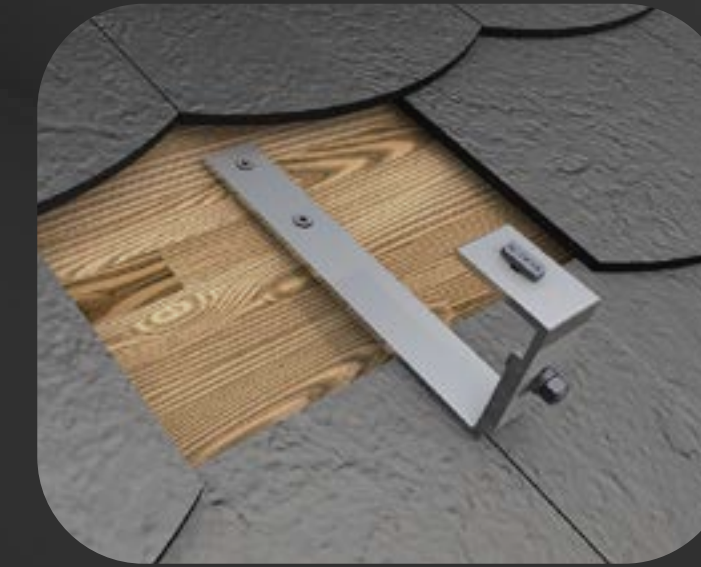

02.1V

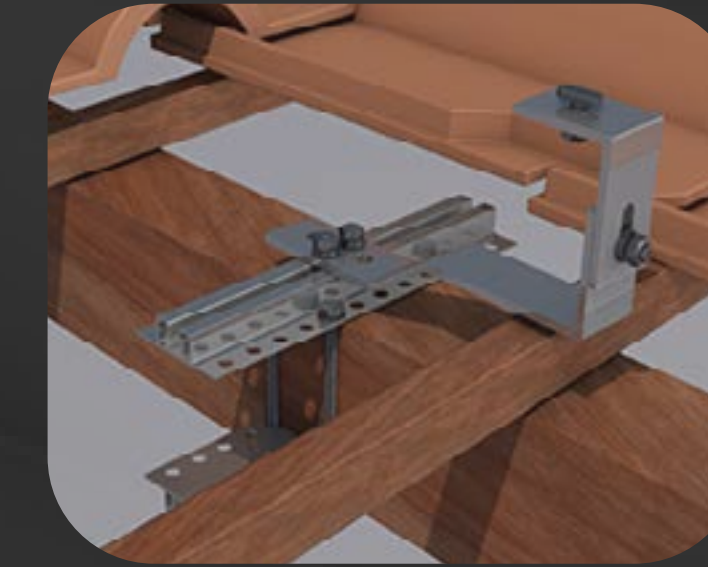

02.2V



02.3V

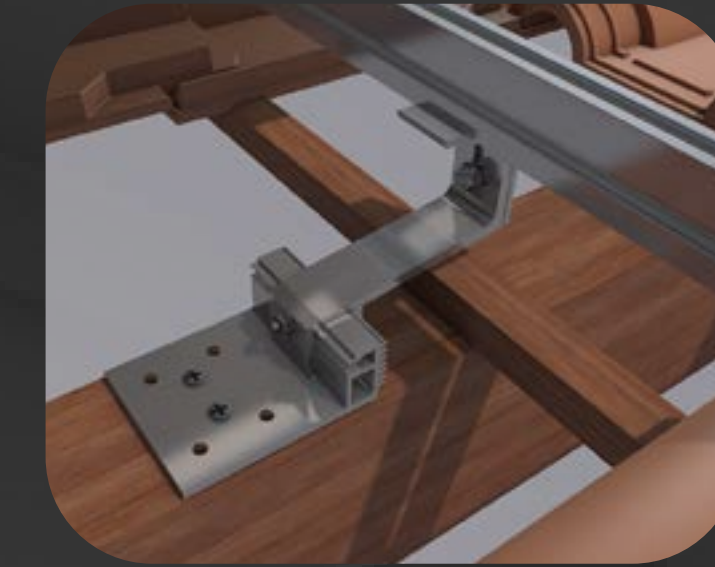

02.4V

Cubierta metálica

Carril Continuo

Fijación mejorada clip



01.1V

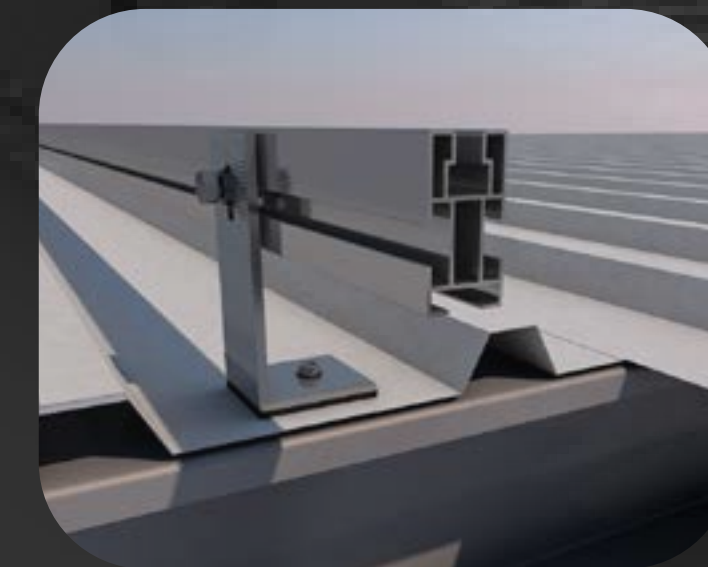

03V

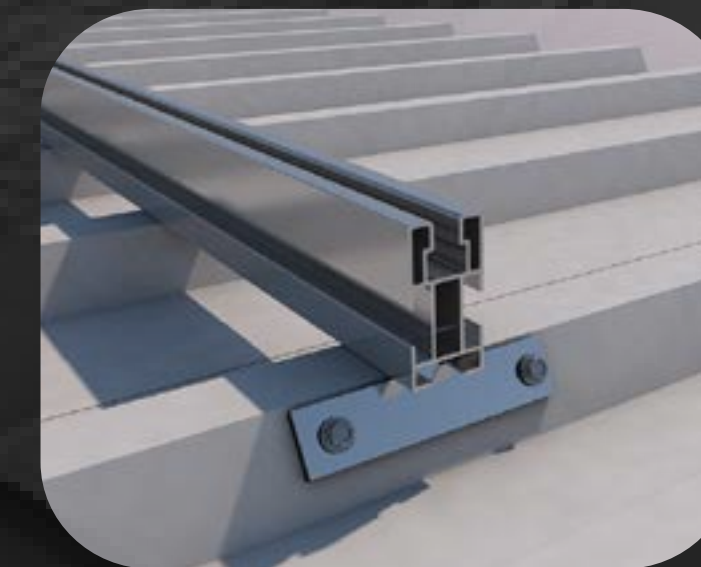

04V

Micro-rail

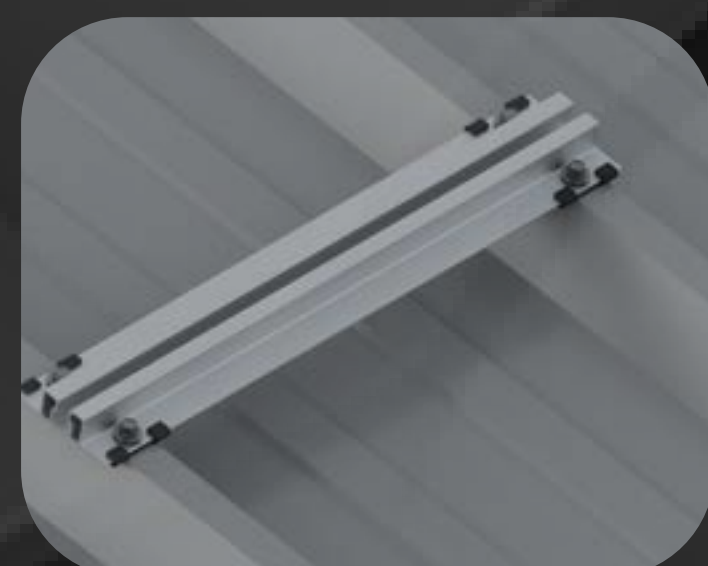

05V



07H



07.1H

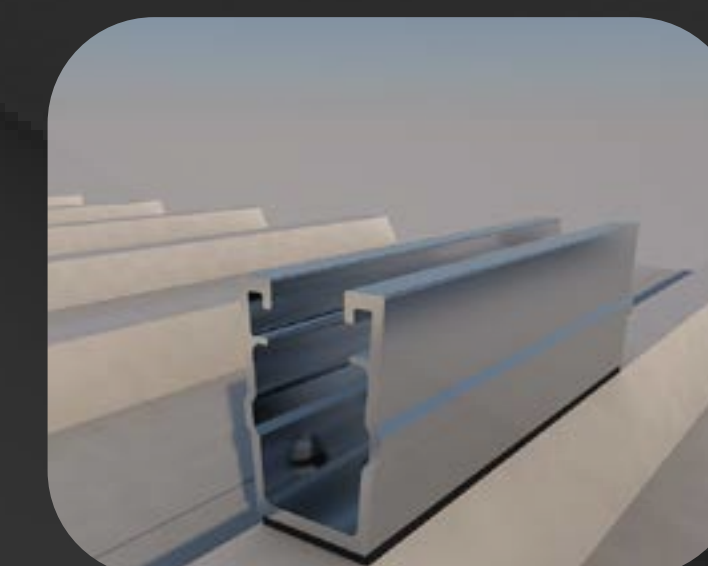

61H

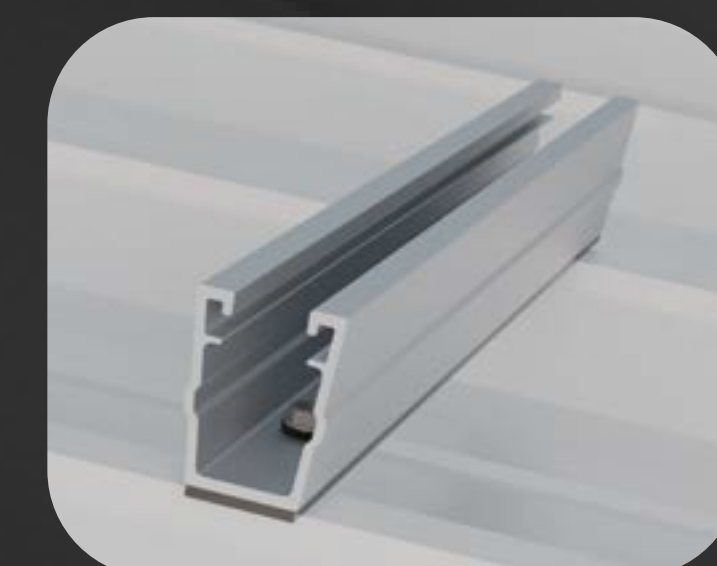

62V

ESPECIFICACIONES

Superficie de instalación	Cubierta de teja
Superficie de anclaje	Losa de hormigón y viga de madera
Fijación de anclaje	Atornillada
Tornillería de anclaje	Tornillo doble rosca con arandela de sellado
Tamaño máximo del panel Kit	2279x1150 mm
Tamaño máximo del panel Bulk	2400x1350 mm
Espesor del panel	28-40 mm
Perfilería	Aluminio EN AW-6005A T6 (Crudo o anodizado)
Tornillería	Acero inoxidable A2-70
Junta de estanqueidad	EPDM

TEJAS COMPATIBLES CON LA FIJACIÓN



Curva/Árabe Mixta plana Mixta curva Hormigón Alicantina Plana lisa



Disposición módulos vertical.



Disposición módulos horizontal.

KITS	01V1	01V2	01V3	01V4	01V5	01V6	SIST. UNIÓN	S15
------	------	------	------	------	------	------	-------------	-----

COMPONENTES DEL KIT



S01



G1



TG1

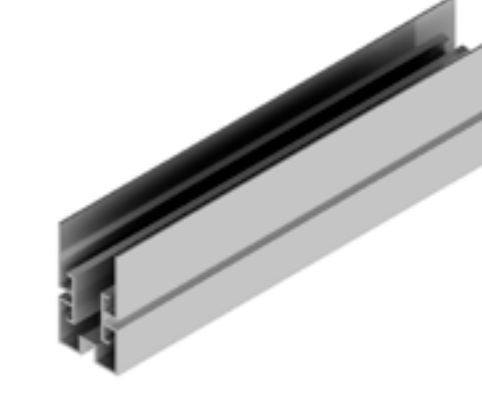

UG1

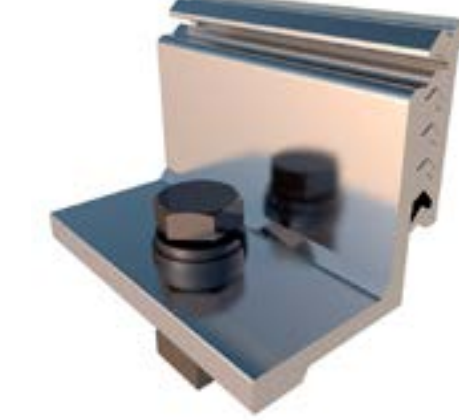

S10



S11



Formato Kit



Formato Bulk



Disponible en Sunfer Project

[Ver Vídeo](#)

[Ver manual de montaje](#)

ESPECIFICACIONES

Superficie de instalación	Cubierta de teja
Superficie de anclaje	Losa de hormigón
Fijación de anclaje	Salvateja
Tornillería de anclaje	No incluida
Tamaño máximo del panel Kit	2279x1150 mm
Tamaño máximo del panel Bulk	2400x1350 mm
Espesor del panel	28-40 mm
Perfilería	Aluminio EN AW-6005A T6 (Crudo o anodizado)
Tornillería	Acero inoxidable A2-70
Junta de estanqueidad	No

TEJAS COMPATIBLES CON LA FIJACIÓN

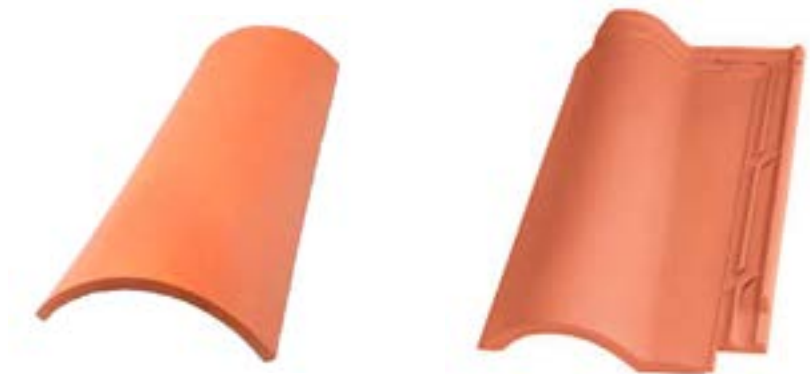

Curva/Árabe* Mixta plana

*Solo es posible para teja curva por la parte del río.



Disposición módulos vertical.



Disposición módulos horizontal.

KITS

02V1

02V2

02V3

02V4

02V5

02V6

SIST. UNIÓN

S15

COMPONENTES DEL KIT

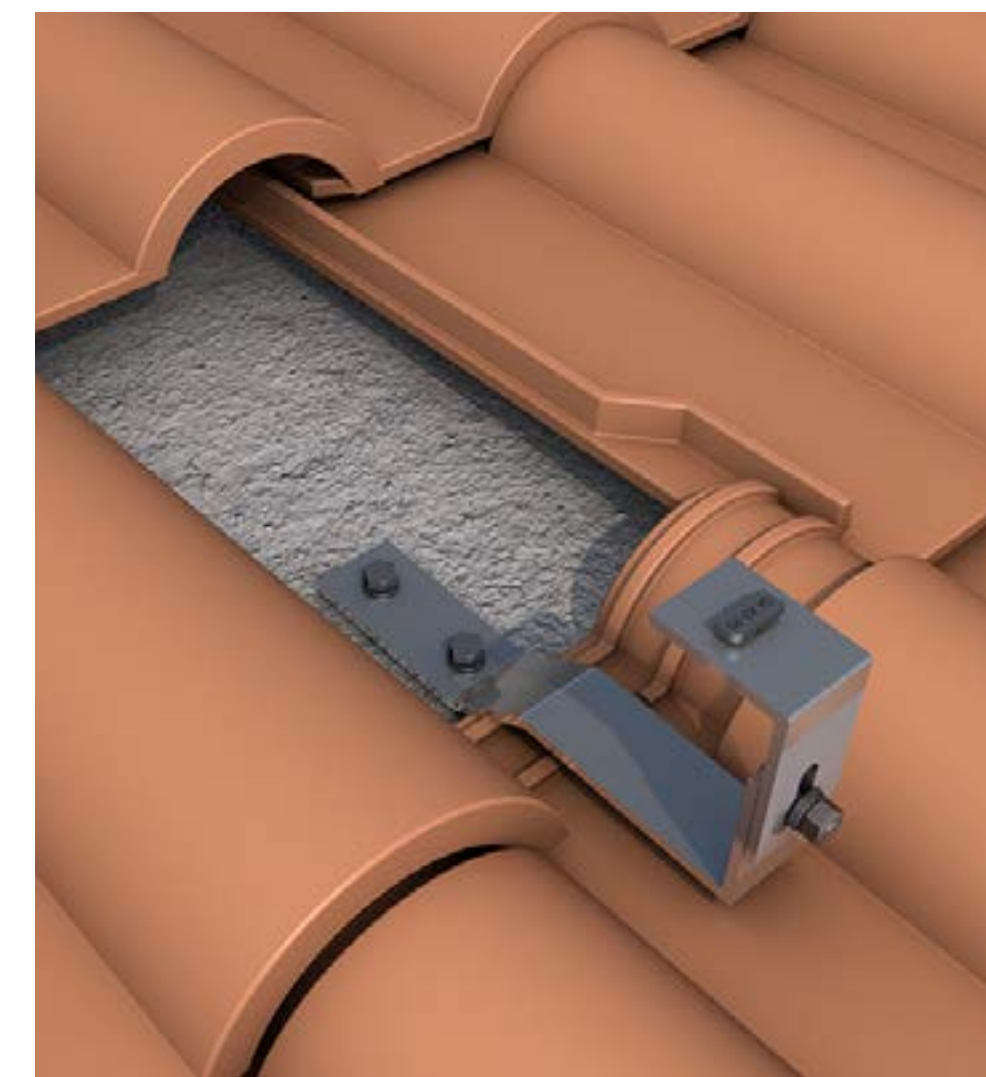
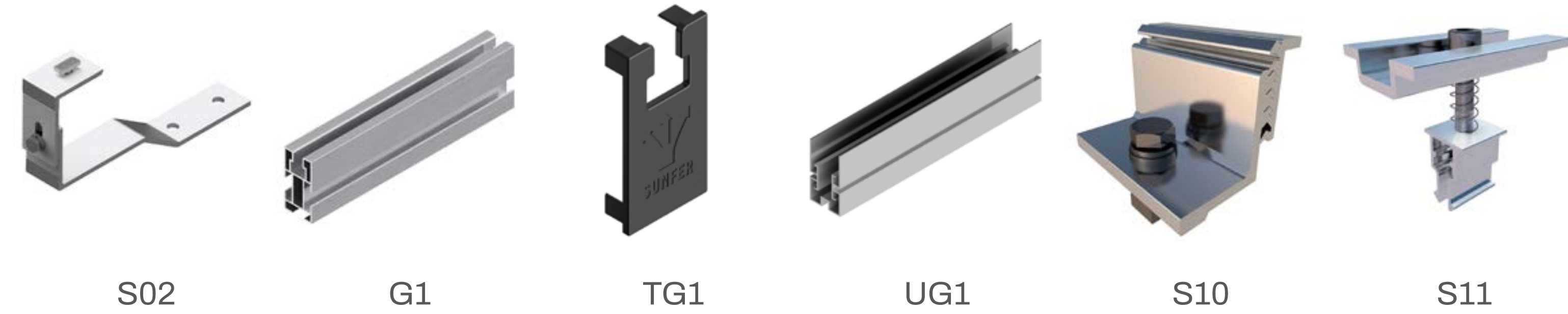

Formato Kit



Formato Bulk



Disponible en Sunfer Project

[Ver Vídeo](#)

[Ver manual de montaje](#)

ESPECIFICACIONES

Superficie de instalación	Cubierta de teja
Superficie de anclaje	Losa de hormigón y viga de madera
Fijación de anclaje	Salvateja
Tornillería de anclaje	No incluida
Tamaño máximo del panel Kit	2279x1150 mm
Tamaño máximo del panel Bulk	2400x1350 mm
Espesor del panel	28-40 mm
Perfilería	Aluminio EN AW-6005A T6 (Crudo o anodizado)
Tornillería	Acero inoxidable A2-70
Junta de estanqueidad	No

TEJAS COMPATIBLES CON LA FIJACIÓN



Pizarra

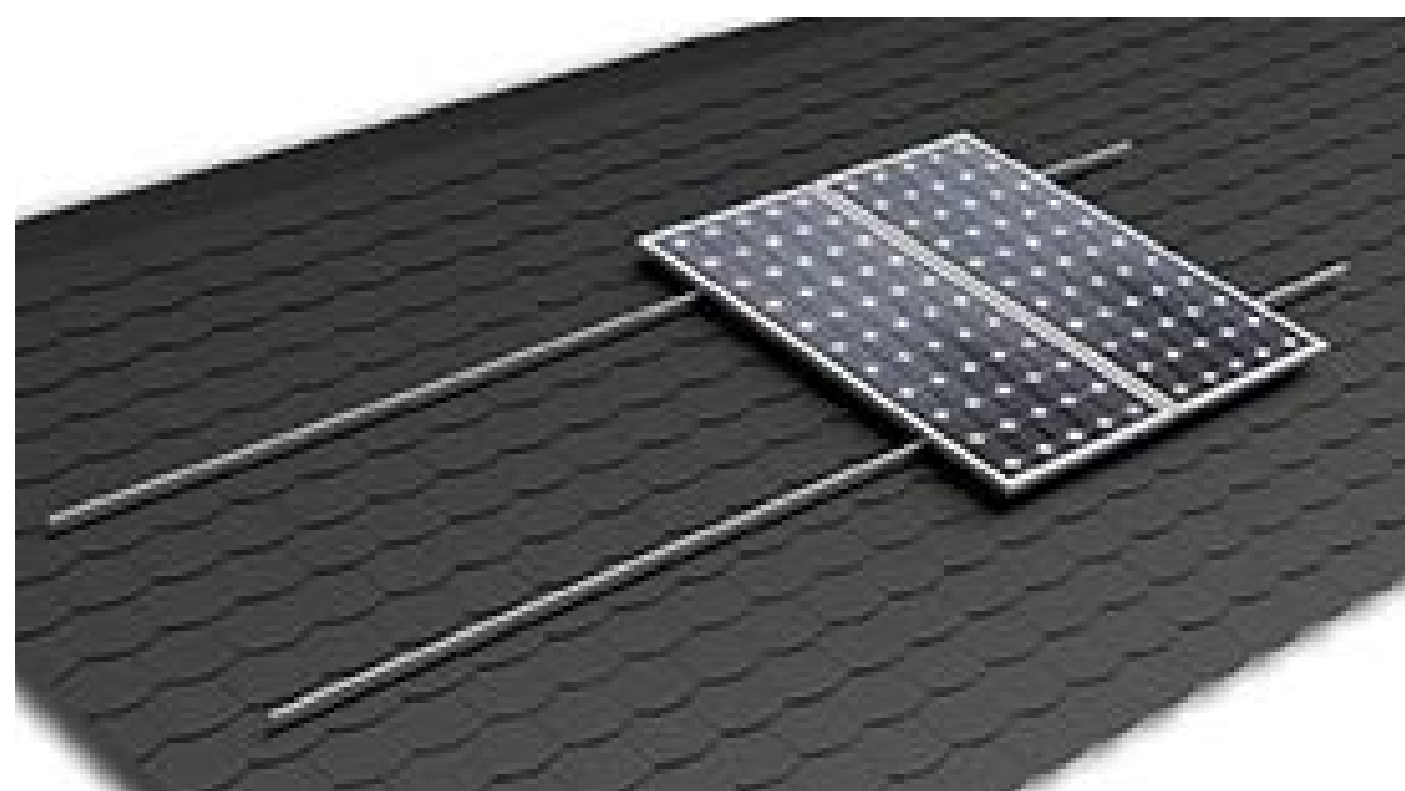

Disposición módulos vertical.

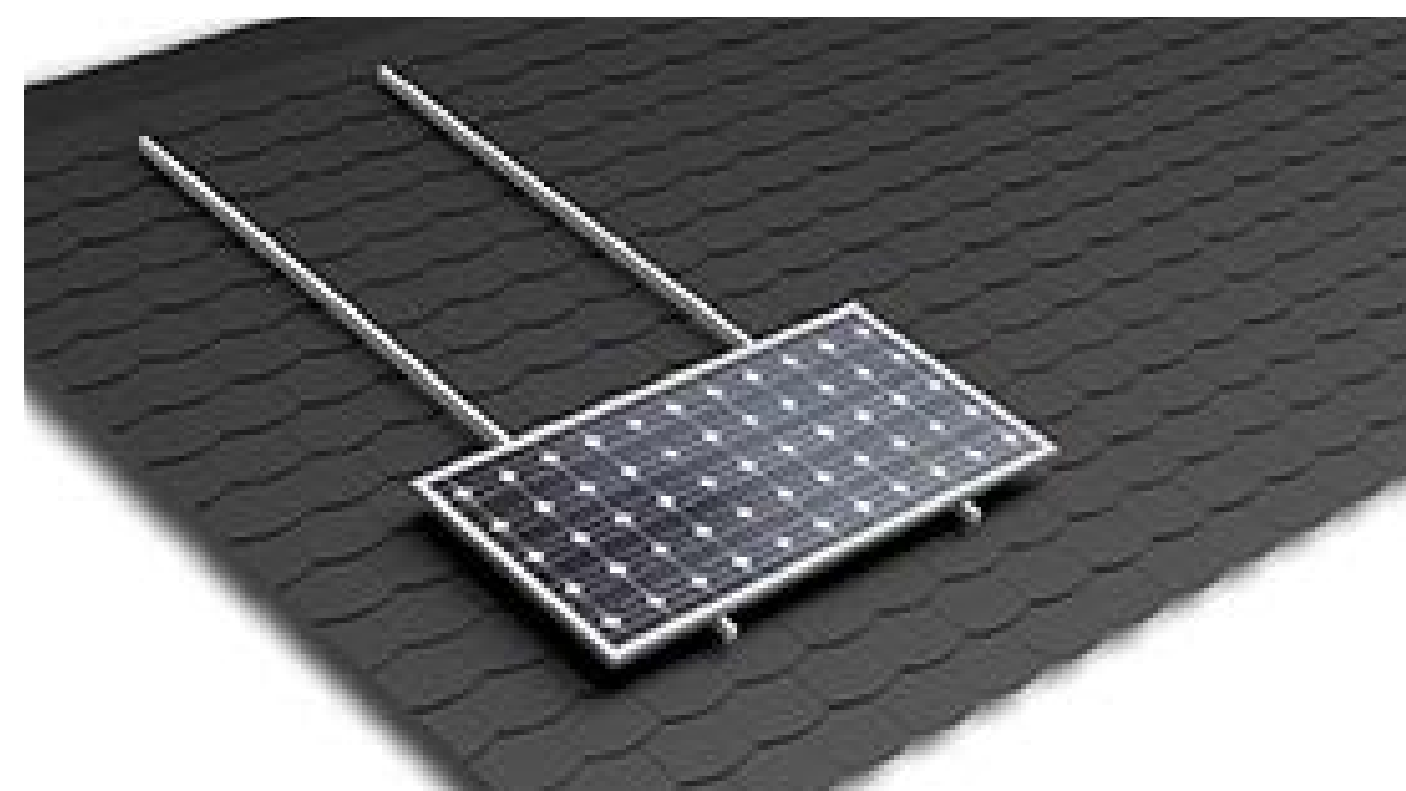

Disposición módulos horizontal.

KITS

02.1V1

02.1V2

02.1V3

02.1V4

02.1V5

02.1V6

SIST. UNIÓN

S15

COMPONENTES DEL KIT



S02.1



G1



TG1

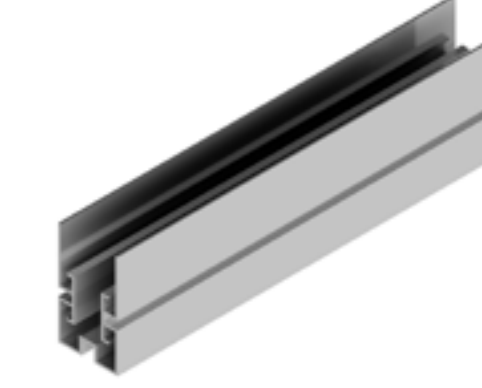

UG1

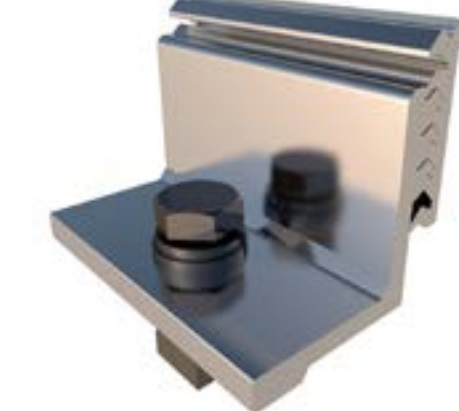

S10



S11



Formato Kit



Formato Bulk



Disponible en Sunfer Project

[Ver Vídeo](#)

[Ver manual de montaje](#)

ESPECIFICACIONES

Superficie de instalación	Cubierta de teja
Superficie de anclaje	Viga de madera, acero o vigueta de hormigón
Fijación de anclaje	Salvateja abrazaviga
Tornillería de anclaje	Incluida en la fijación
Tamaño máximo del panel Kit	2279x1150 mm
Tamaño máximo del panel Bulk	2400x1350 mm
Espesor del panel	28-40 mm
Perfilería	Aluminio EN AW-6005A T6 (Crudo o anodizado)
Tornillería	Acero inoxidable A2-70
Junta de estanqueidad	No

TEJAS COMPATIBLES CON LA FIJACIÓN



Mixta plana* Mixta curva* Hormigón* Alicantina Plana lisa

*Siempre que la parte plana de la teja sea de 50 mm o superior.



Disposición módulos vertical.



Disposición módulos horizontal.

KITS	02.2V1	02.2V2	02.2V3	02.2V4	02.2V5	02.2V6	SIST. UNIÓN	S15
------	--------	--------	--------	--------	--------	--------	-------------	-----

COMPONENTES DEL KIT

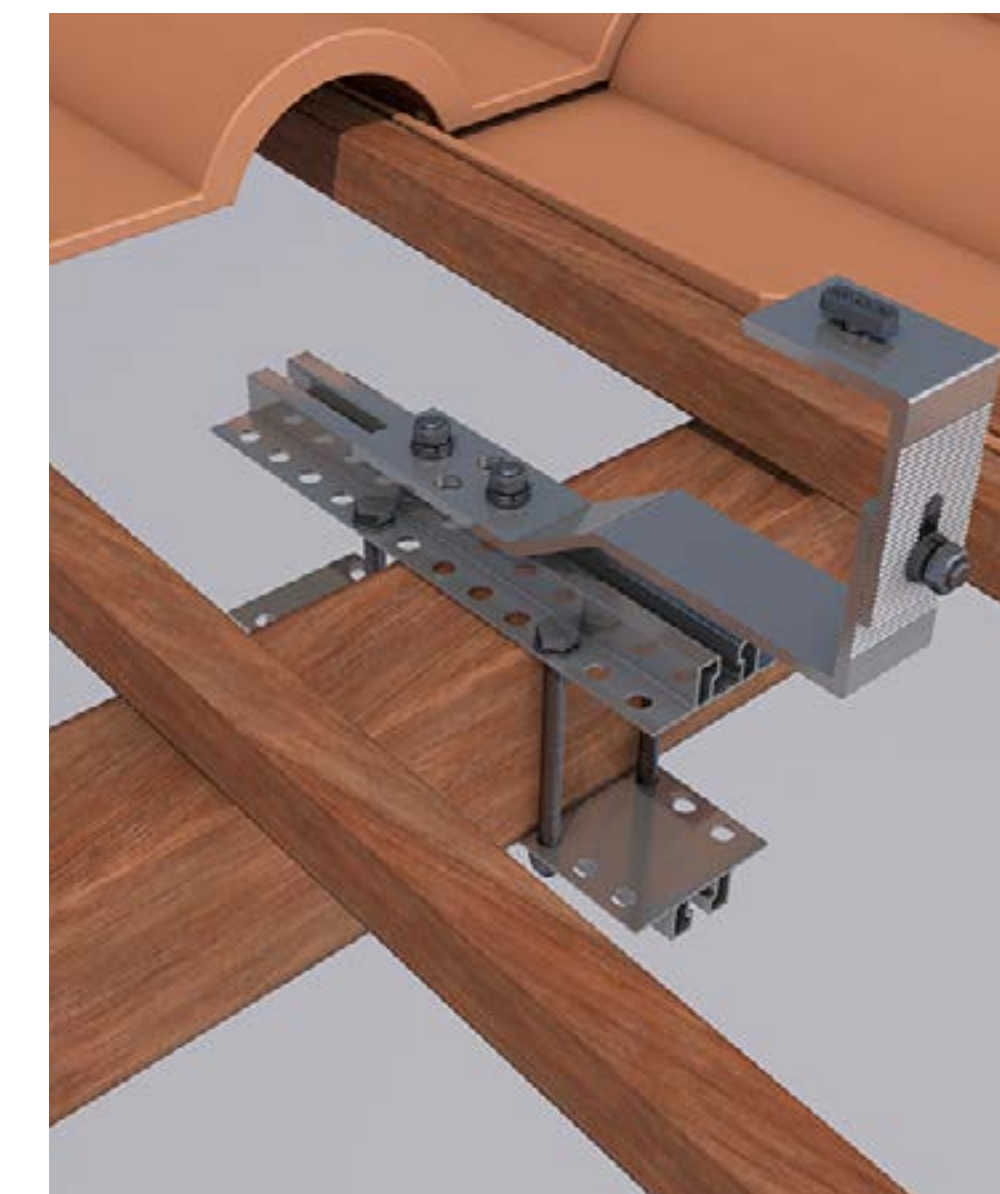
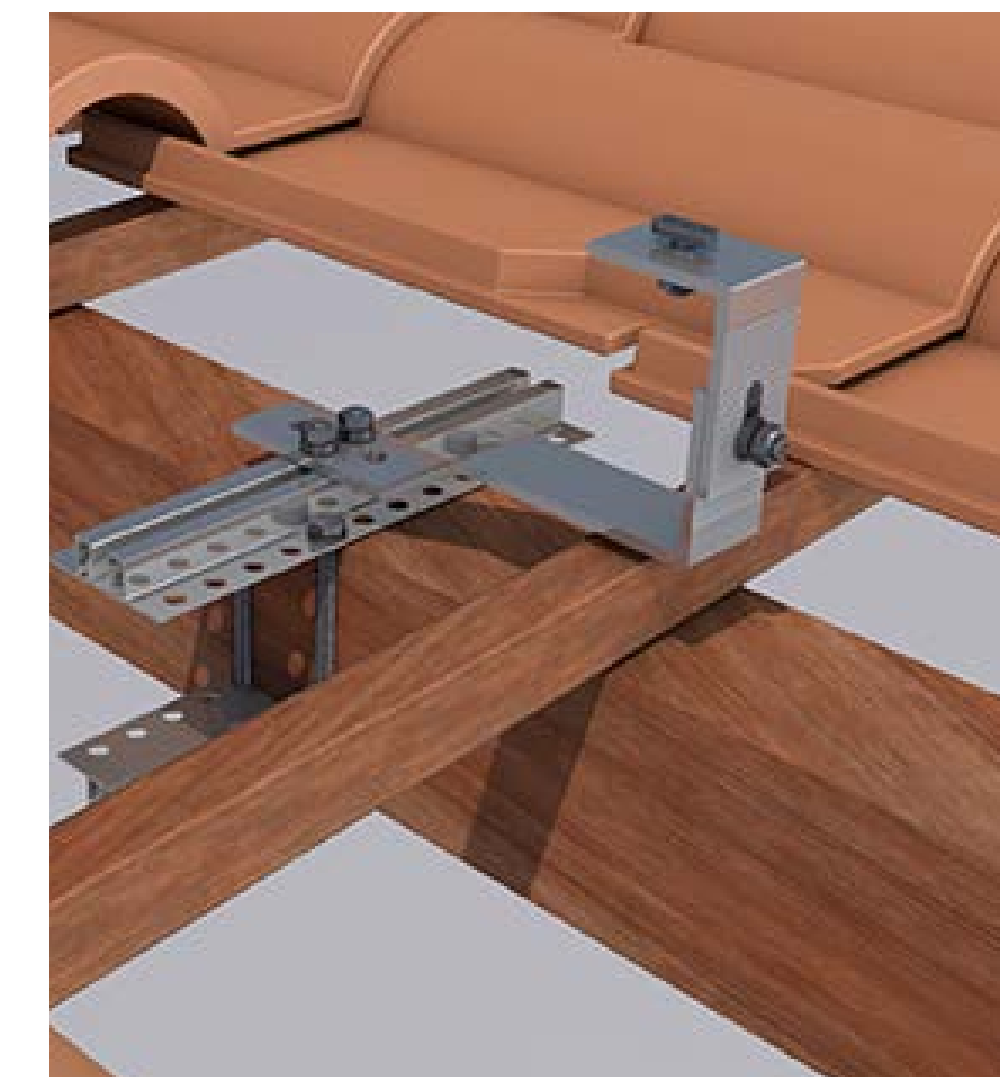
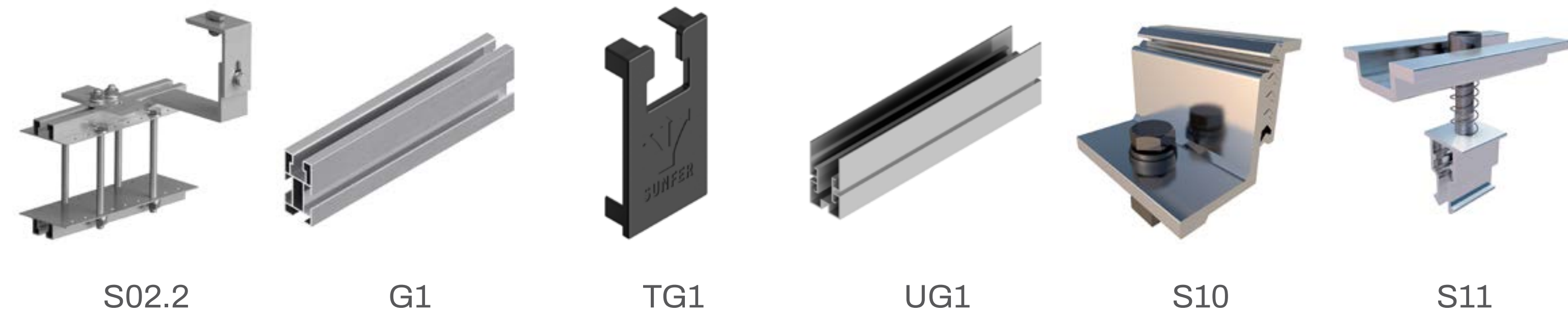

Formato Kit



Formato Bulk



Disponible en Sunfer Project

[Ver Vídeo](#)

[Ver manual de montaje](#)

ESPECIFICACIONES

Superficie de instalación	Cubierta de teja
Superficie de anclaje	Losa de hormigón
Fijación de anclaje	Salvateja
Tornillería de anclaje	No incluida
Tamaño máximo del panel Kit	2279x1150 mm
Tamaño máximo del panel Bulk	2400x1350 mm
Espesor del panel	28-40 mm
Perfilería	Aluminio EN AW-6005A T6 (Crudo o anodizado)
Tornillería	Acero inoxidable A2-70
Junta de estanqueidad	No

TEJAS COMPATIBLES CON LA FIJACIÓN



Curva/Árabe Mixta plana Mixta curva



Disposición módulos vertical.



Disposición módulos horizontal.

KITS	02.3V1	02.3V2	02.3V3	02.3V4	02.3V5	02.3V6	SIST. UNIÓN	S15
------	--------	--------	--------	--------	--------	--------	-------------	-----

COMPONENTES DEL KIT

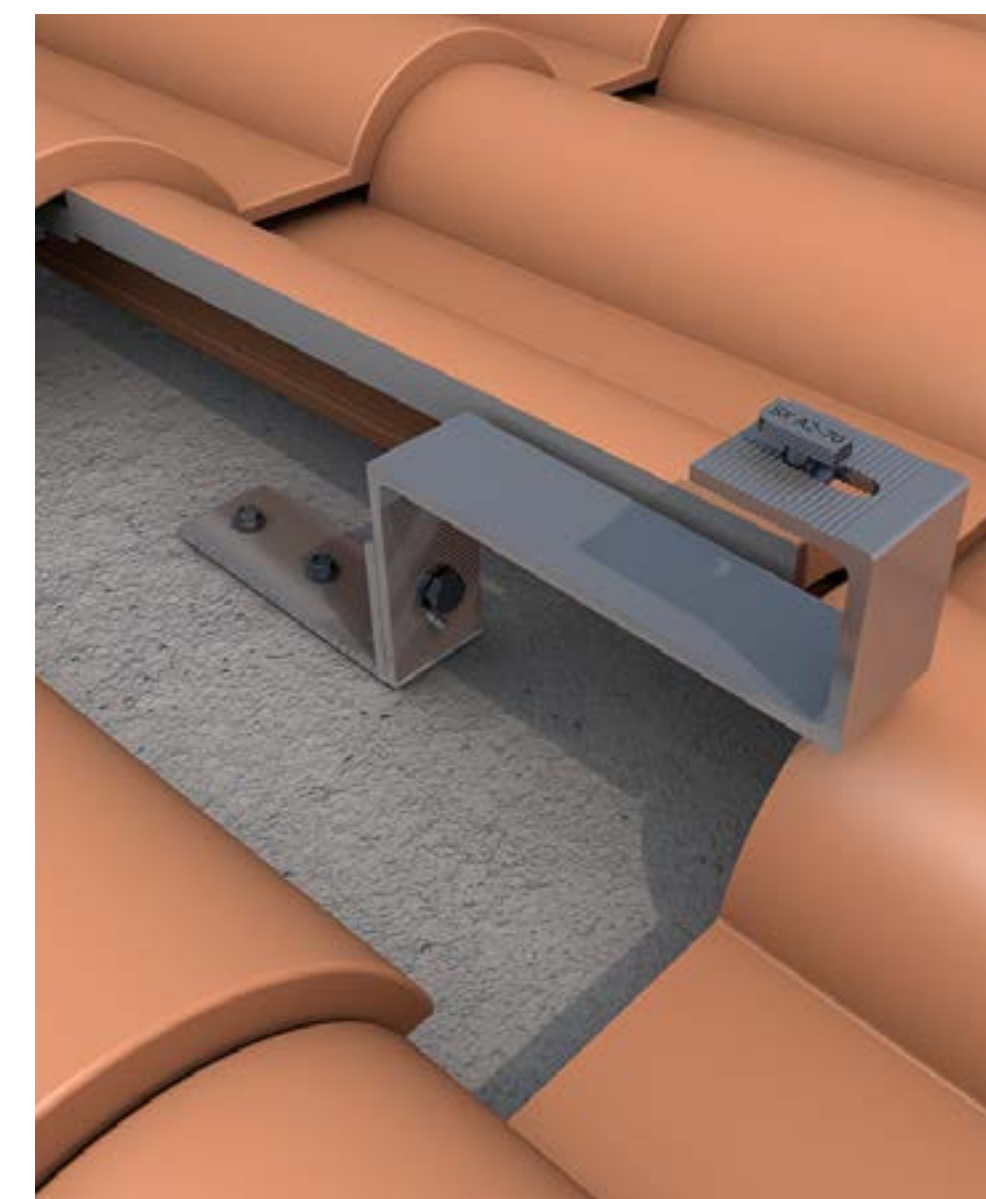
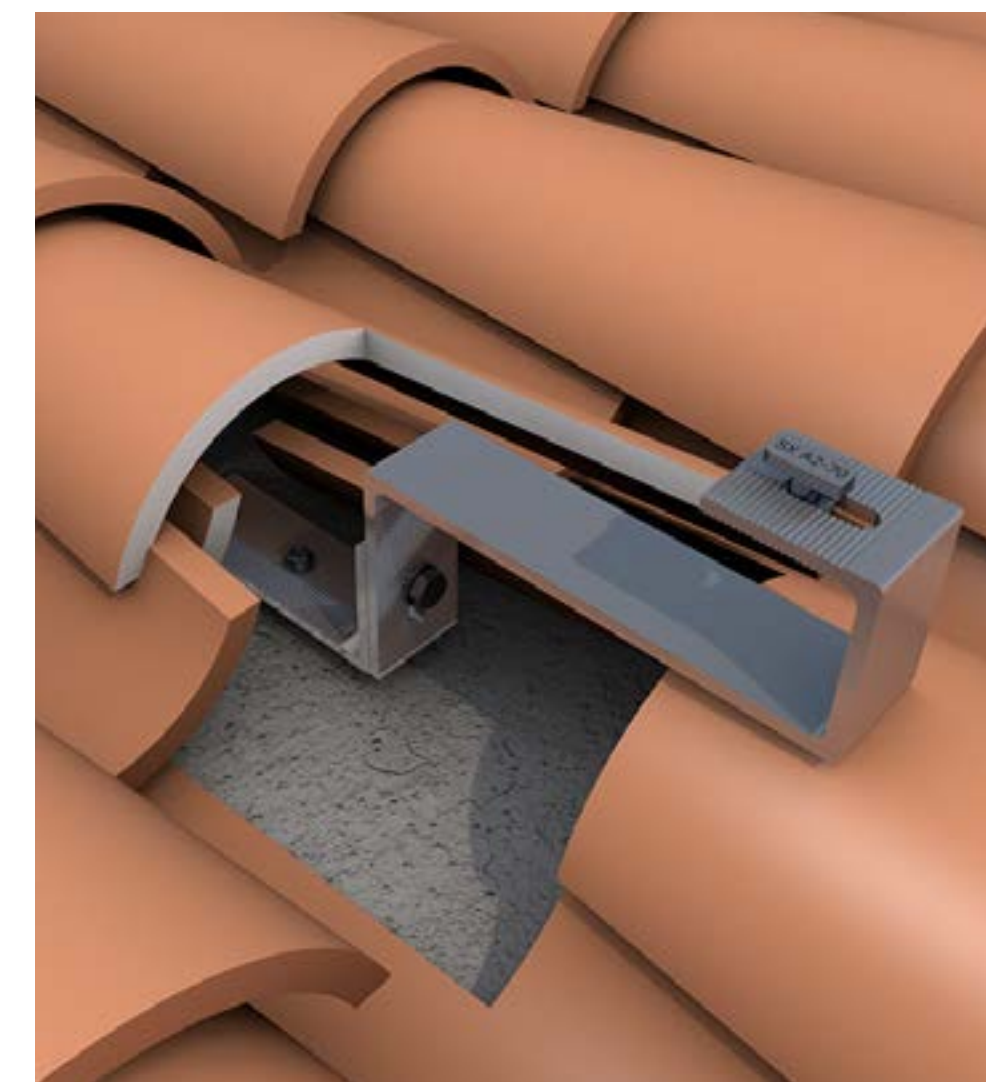
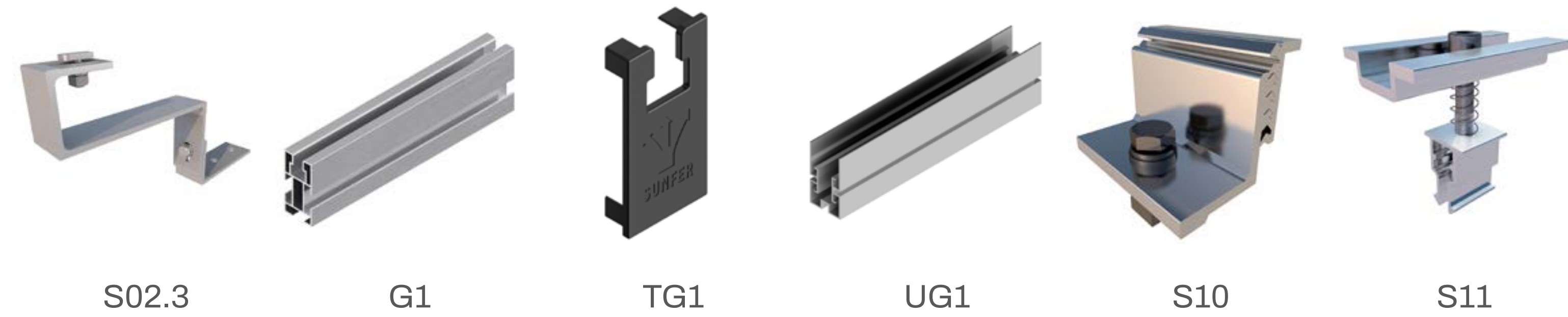

Formato Kit



Formato Bulk



Disponible en Sunfer Project

[Ver Vídeo](#)

[Ver manual de montaje](#)

ESPECIFICACIONES

Superficie de instalación	Cubierta de teja
Superficie de anclaje	Losa de hormigón o viga de madera
Fijación de anclaje	Salvateja
Tornillería de anclaje	No incluida
Tamaño máximo del panel Kit	2279x1150 mm
Tamaño máximo del panel Bulk	2400x1350 mm
Espesor del panel	28-40 mm
Perfilería	Aluminio EN AW-6005A T6 (Crudo o anodizado)
Tornillería	Acero inoxidable A2-70

TEJAS COMPATIBLES CON LA FIJACIÓN



Mixta plana Mixta curva Hormigón Alicantina Plana lisa

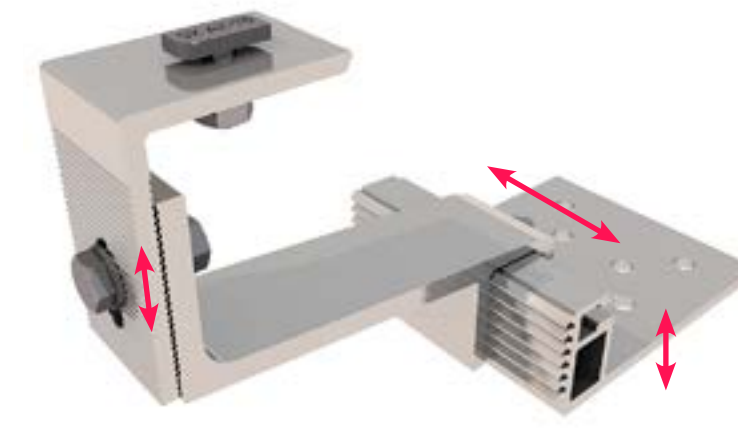

Múltiple regulación



Disposición módulos vertical.



Disposición módulos horizontal.

KITS	02.4V1	02.4V2	02.4V3	02.4V4	02.4V5	02.4V6	SIST. UNIÓN	S15
------	--------	--------	--------	--------	--------	--------	-------------	-----

COMPONENTES DEL KIT

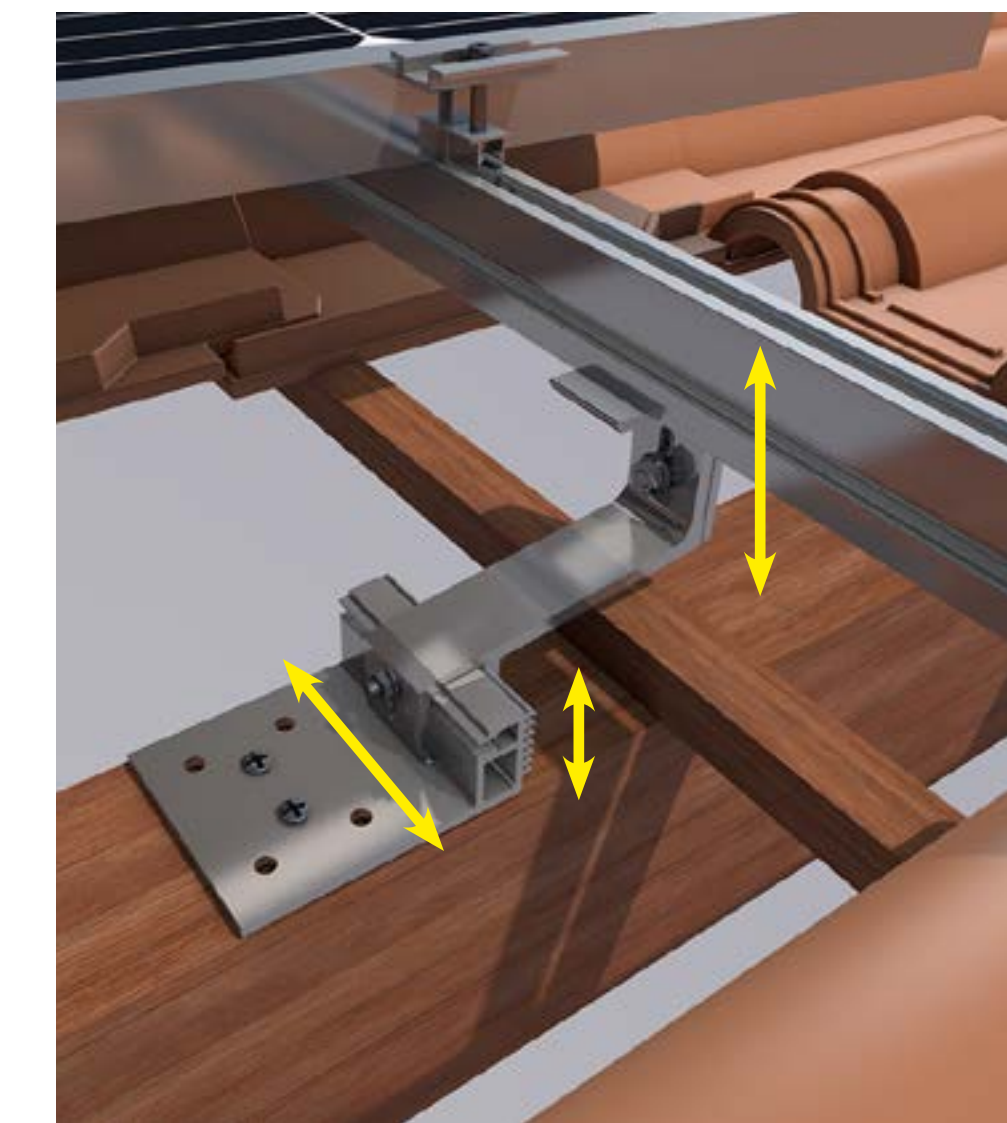
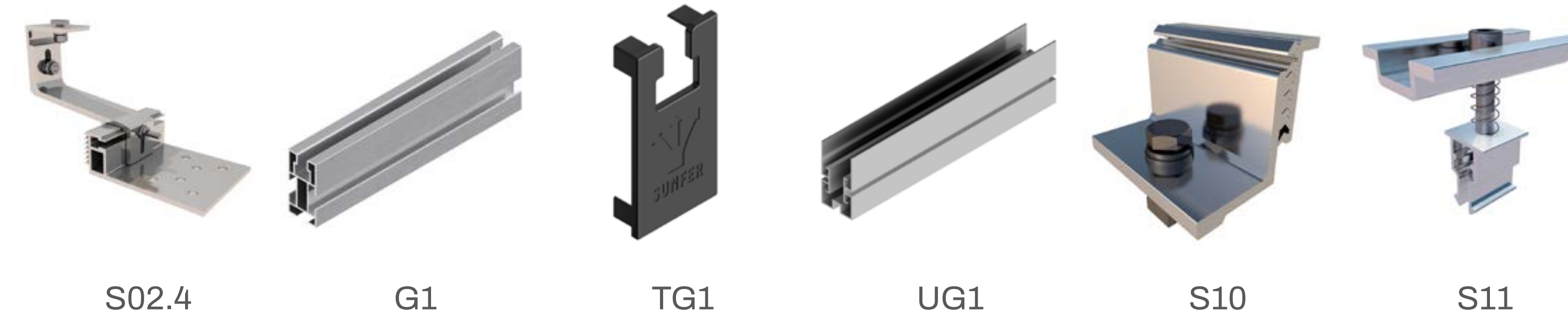

Formato Kit



Formato Bulk



Disponible en Sunfer Project

[Ver Vídeo](#)

[Ver manual de montaje](#)

ESPECIFICACIONES

Superficie de instalación	Chapa metálica
Superficie de anclaje	Anclaje a correas metálicas
Fijación de anclaje	Atornillada
Tornillería de anclaje	Tornillo autotaladrante con junta de estanqueidad
Tamaño máximo del panel Kit	2279x1150 mm
Tamaño máximo del panel Bulk	2400x1350 mm
Espesor del panel	28-40 mm
Perfilería	Aluminio EN AW-6005A T6 (Crudo o anodizado)
Tornillería	Acero inoxidable A2-70
Junta de estanqueidad	EPDM

CHAPAS COMPATIBLES CON LA FIJACIÓN



Disposición módulos horizontal.
No es viable disposición módulos vertical.

KITS	01.1V1	01.1V2	01.1V3	01.1V4	01.1V5	01.1V6	SIST. UNIÓN	S15
------	--------	--------	--------	--------	--------	--------	-------------	-----

COMPONENTES DEL KIT

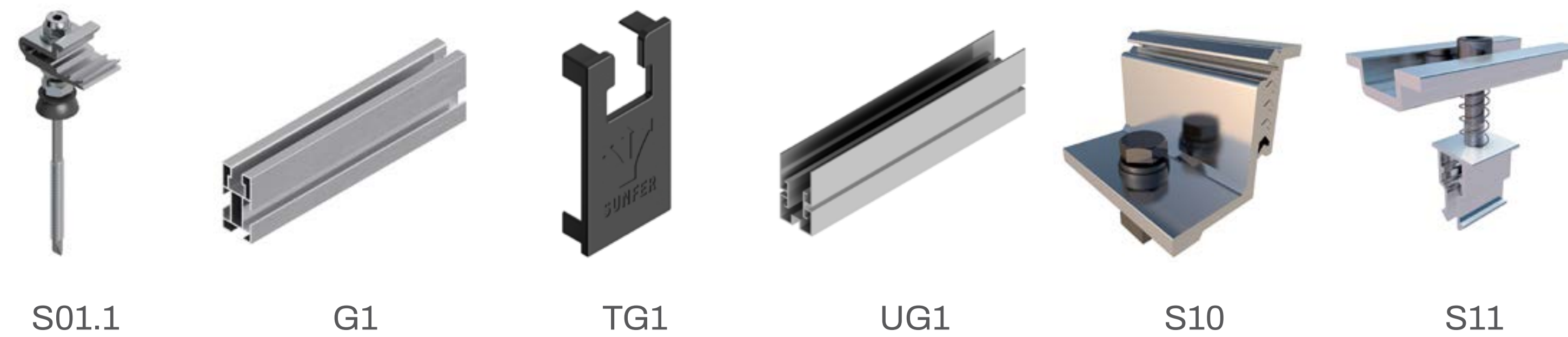

Fijación mejorada clip

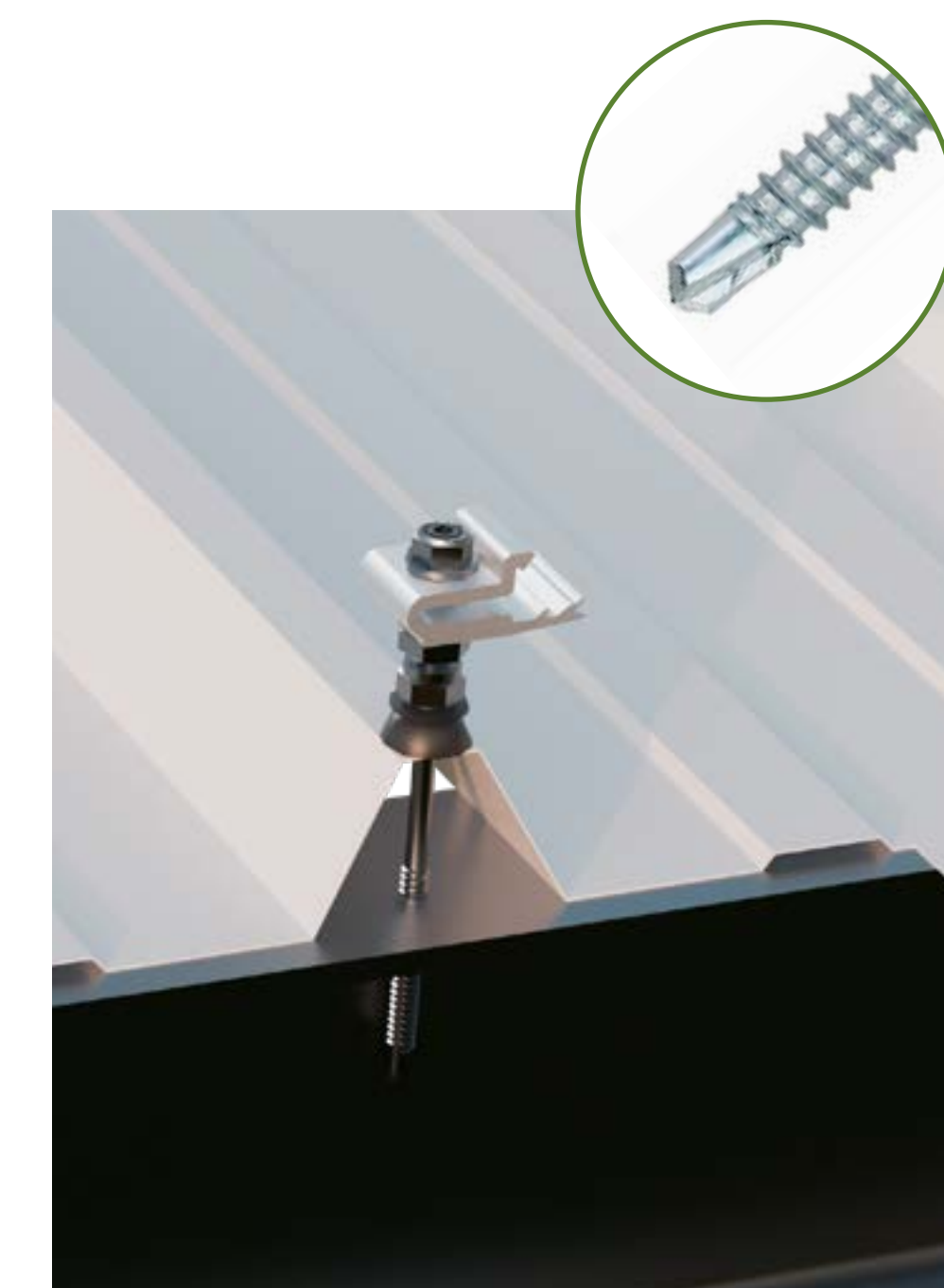
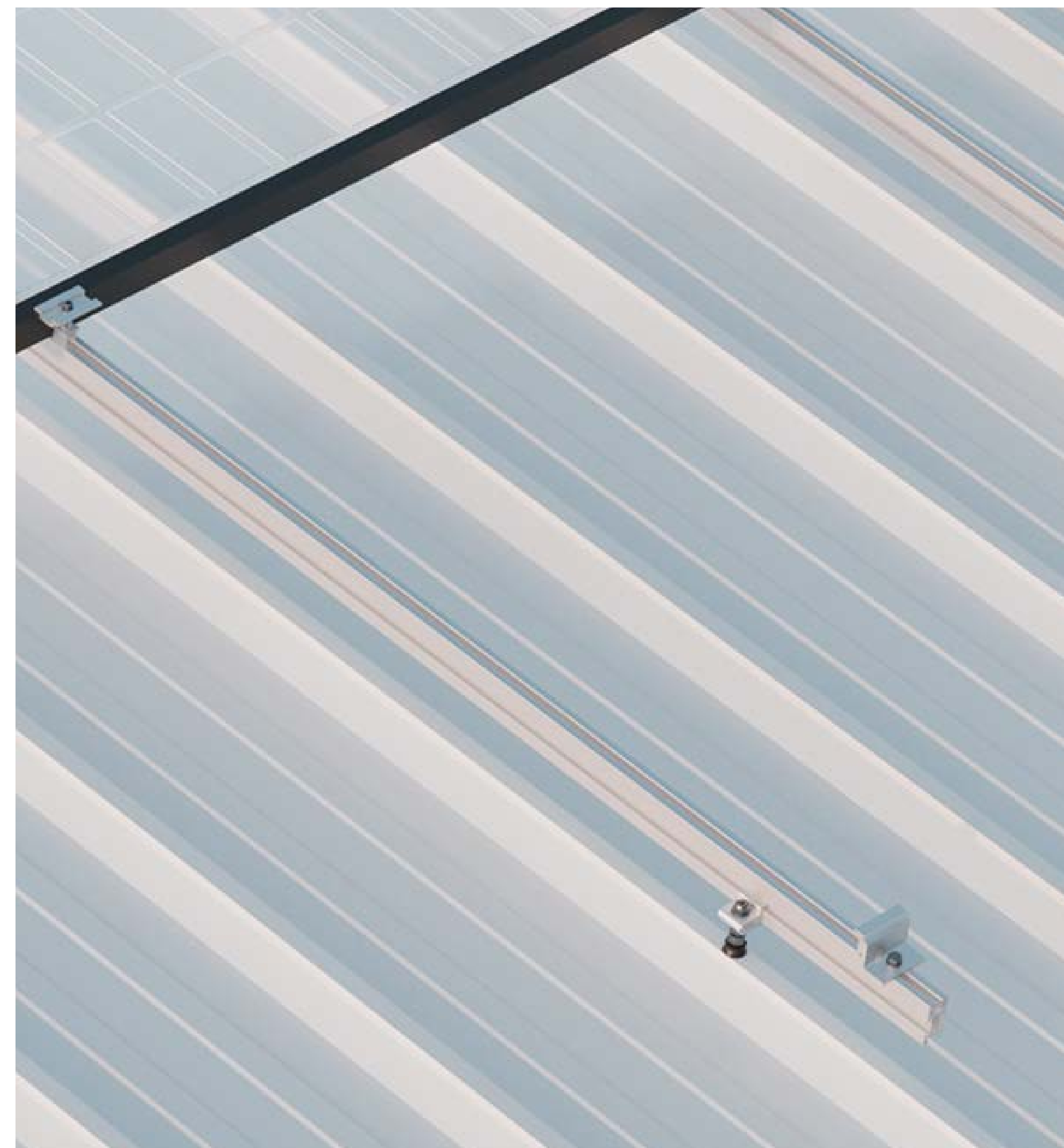

Formato Kit



Formato Bulk



Disponible en
Sunfer Project

Ver Vídeo

Ver manual de montaje

ESPECIFICACIONES

Superficie de instalación	Chapa metálica
Superficie de anclaje	Anclaje a correas metálicas
Fijación de anclaje	Atornillado
Tornillería de anclaje	No incluida
Tamaño máximo del panel Kit	2279x1150 mm
Tamaño máximo del panel Bulk	2400x1350 mm
Espesor del panel	28-40 mm
Perfilería	Aluminio EN AW-6005A T6 (Crudo o anodizado)
Tornillería	Acero inoxidable A2-70
Junta de estanqueidad	EPDM

CHAPAS COMPATIBLES CON LA FIJACIÓN

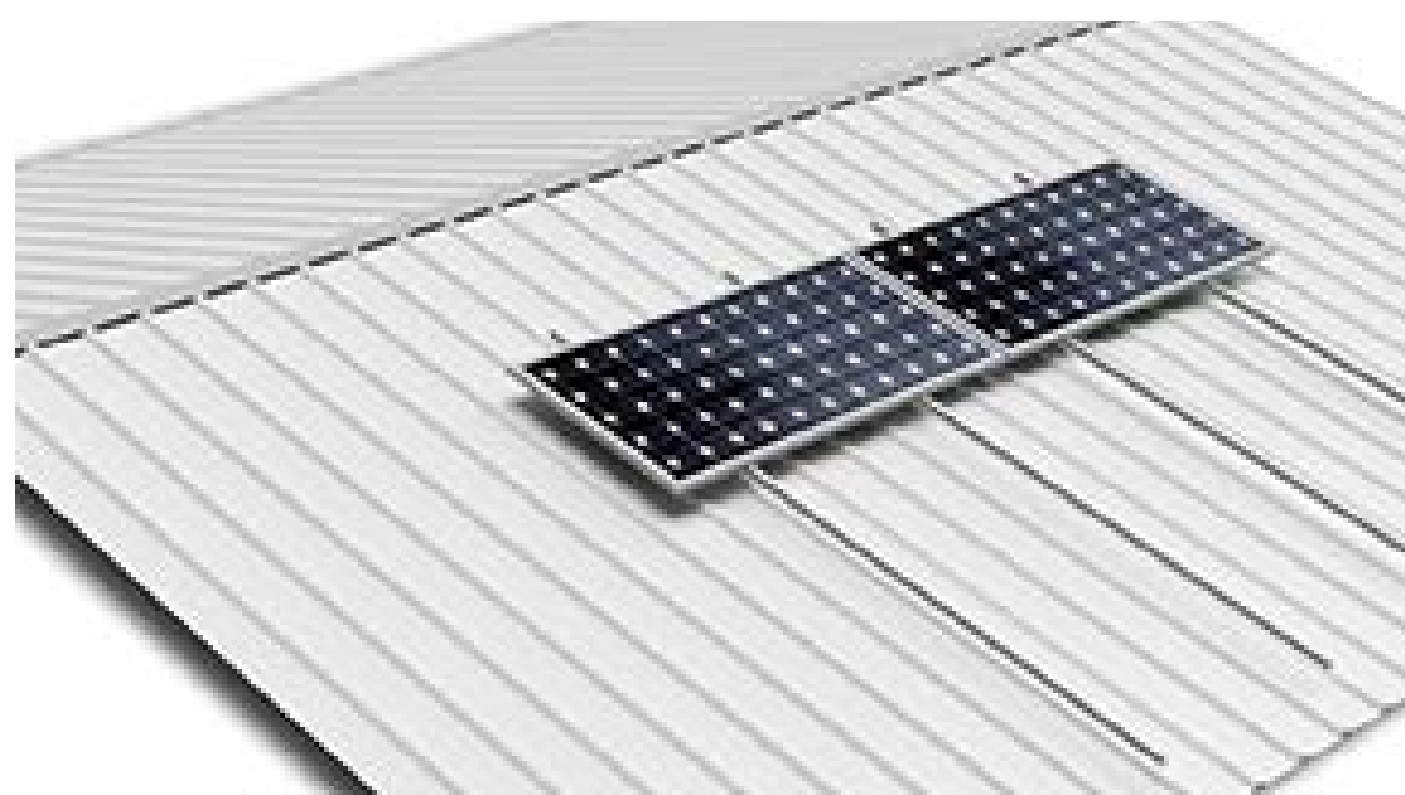

Disposición módulos horizontal.
No es viable disposición módulos vertical.

KITS	03V1	03V2	03V3	03V4	03V5	03V6	SIST. UNIÓN	S15
------	------	------	------	------	------	------	-------------	-----

COMPONENTES DEL KIT

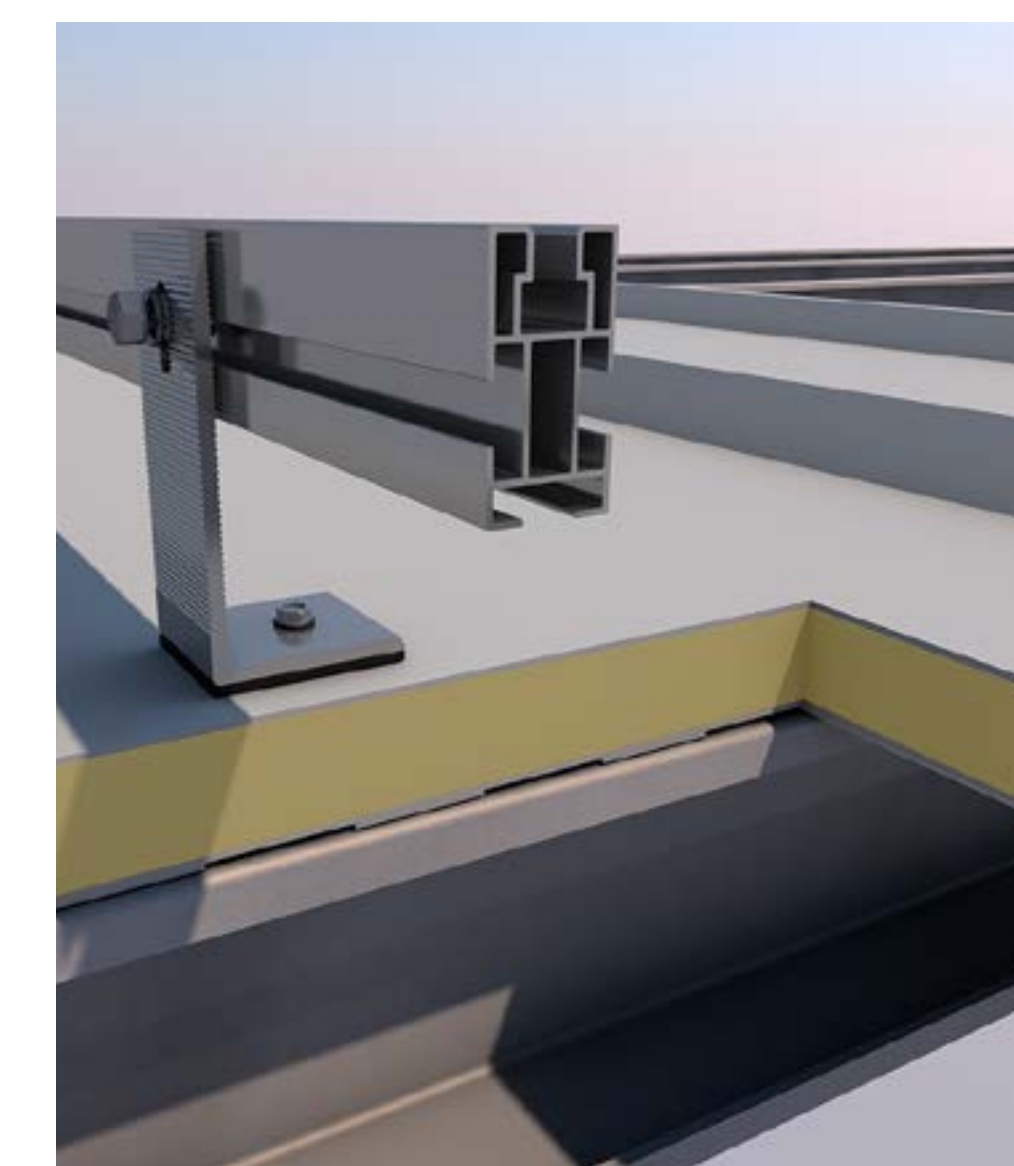
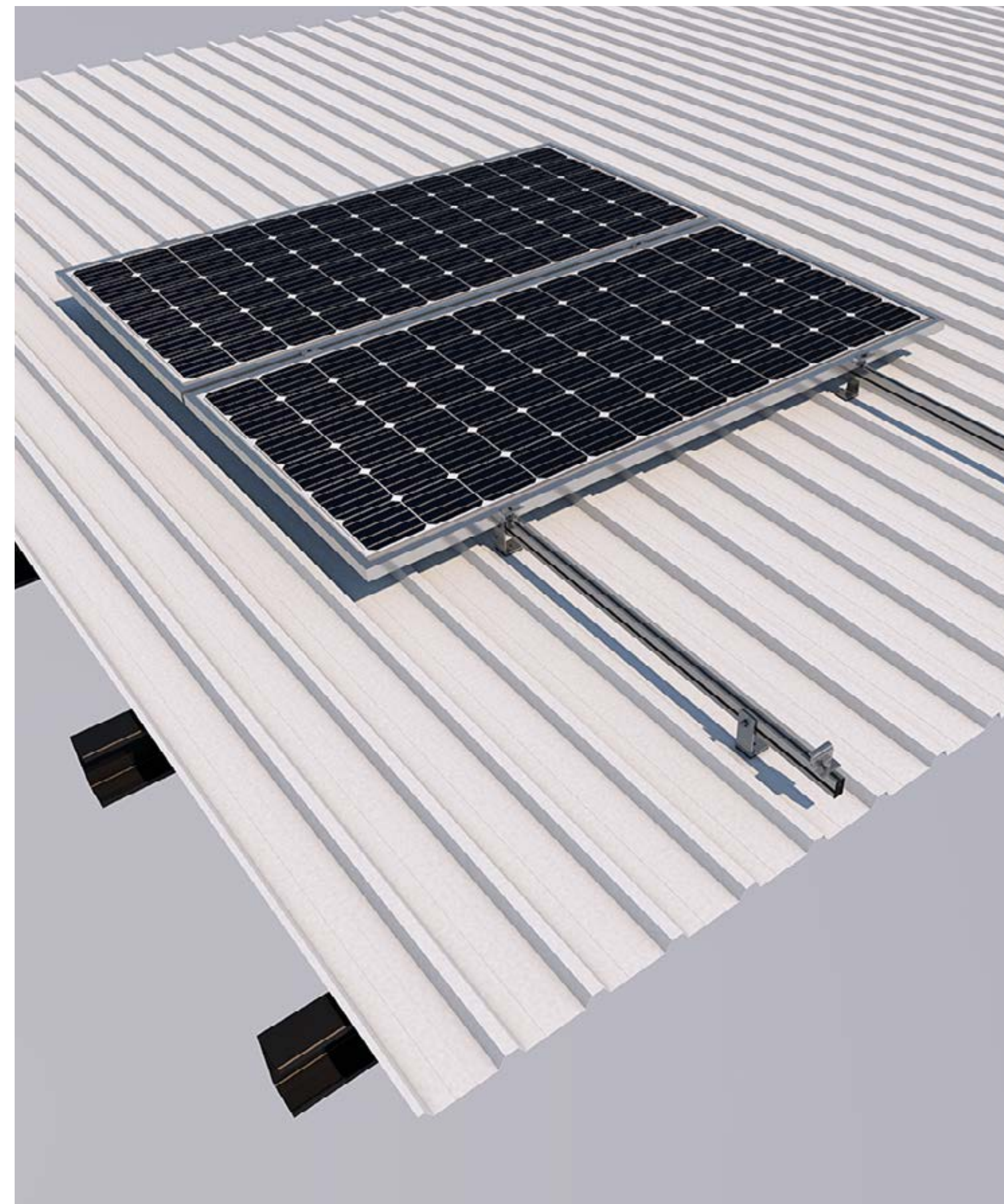
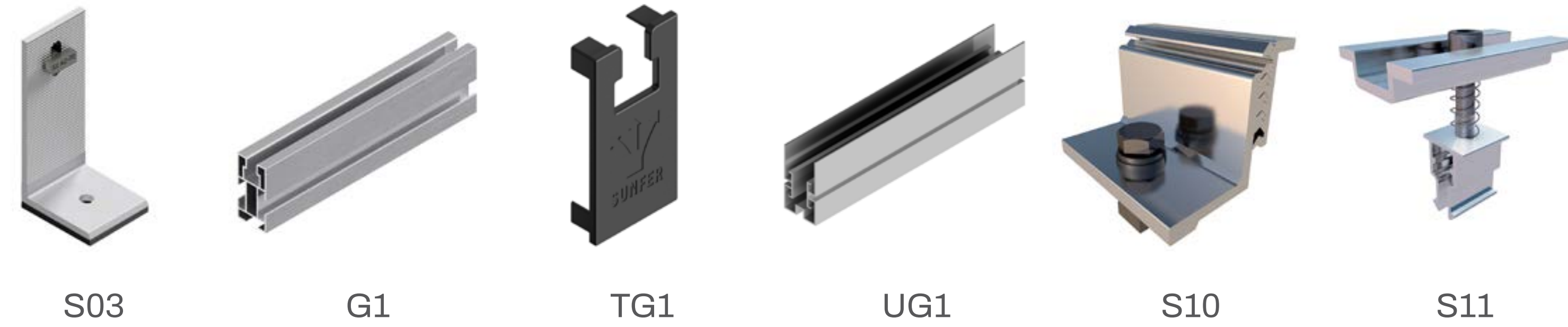

Formato Kit



Formato Bulk



Disponible en Sunfer Project

[Ver Vídeo](#)

[Ver manual de montaje](#)

ESPECIFICACIONES

Superficie de instalación	Chapa metálica
Superficie de anclaje	Anclaje a chapa
Fijación de anclaje	Atornillado
Tornillería de anclaje	Tornillo cincado con arandela de sellado (S42.1)
Tamaño máximo del panel Kit	2279x1150 mm
Tamaño máximo del panel Bulk	2400x1350 mm
Espesor del panel	28-40 mm
Perfilería	Aluminio EN AW-6005A T6 (Crudo o anodizado)
Tornillería	General: Acero inoxidable A2-70 Anclaje: Acero cincado
Junta de estanqueidad	EPDM

CHAPAS COMPATIBLES CON LA FIJACIÓN



Disposición módulos vertical.

KITS	04V1	04V2	04V3	04V4	04V5	04V6	SIST. UNIÓN	S15
------	------	------	------	------	------	------	-------------	-----

COMPONENTES DEL KIT

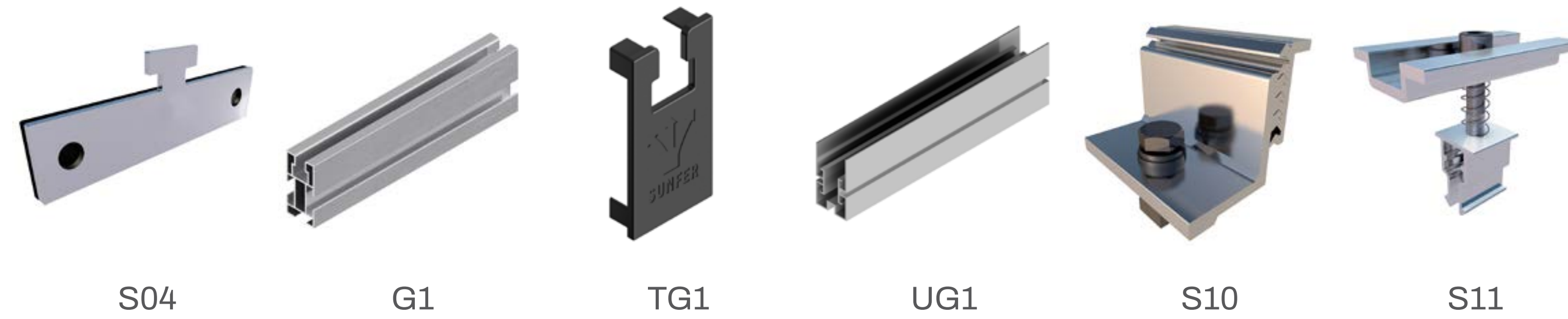

Mín. 45°
Máx. 90°



Mín. 0,5 mm

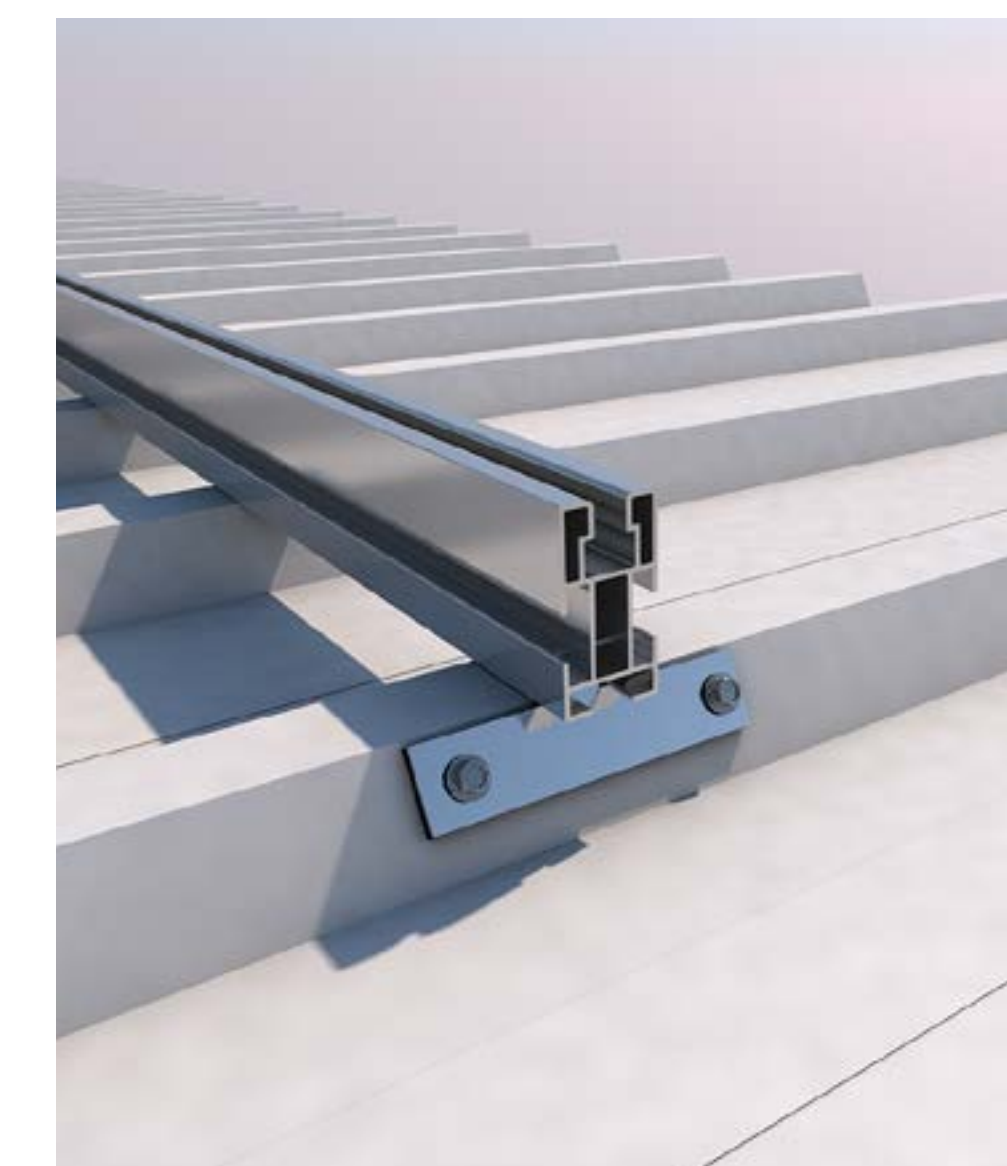

Formato Kit



Formato Bulk



Disponible en
Sunfer Project

[Ver Vídeo](#)

[Ver manual de montaje](#)

ESPECIFICACIONES

Superficie de instalación	Chapa metálica
Superficie de anclaje	Anclaje a chapa
Fijación de anclaje	Atornillado
Tornillería de anclaje	Tornillo cincado con arandela de sellado (S42.1)
Tamaño máximo del panel Kit	2400x1350 mm
Tamaño máximo del panel Bulk	2400x1350 mm
Espesor del panel	28-40 mm
Perfilería	Aluminio EN AW-6005A T6 (Crudo o anodizado)
Tornillería	General: Acero inoxidable A2-70 Anclaje: Acero cincado
Junta de estanqueidad	EPDM

CHAPAS COMPATIBLES CON LA FIJACIÓN

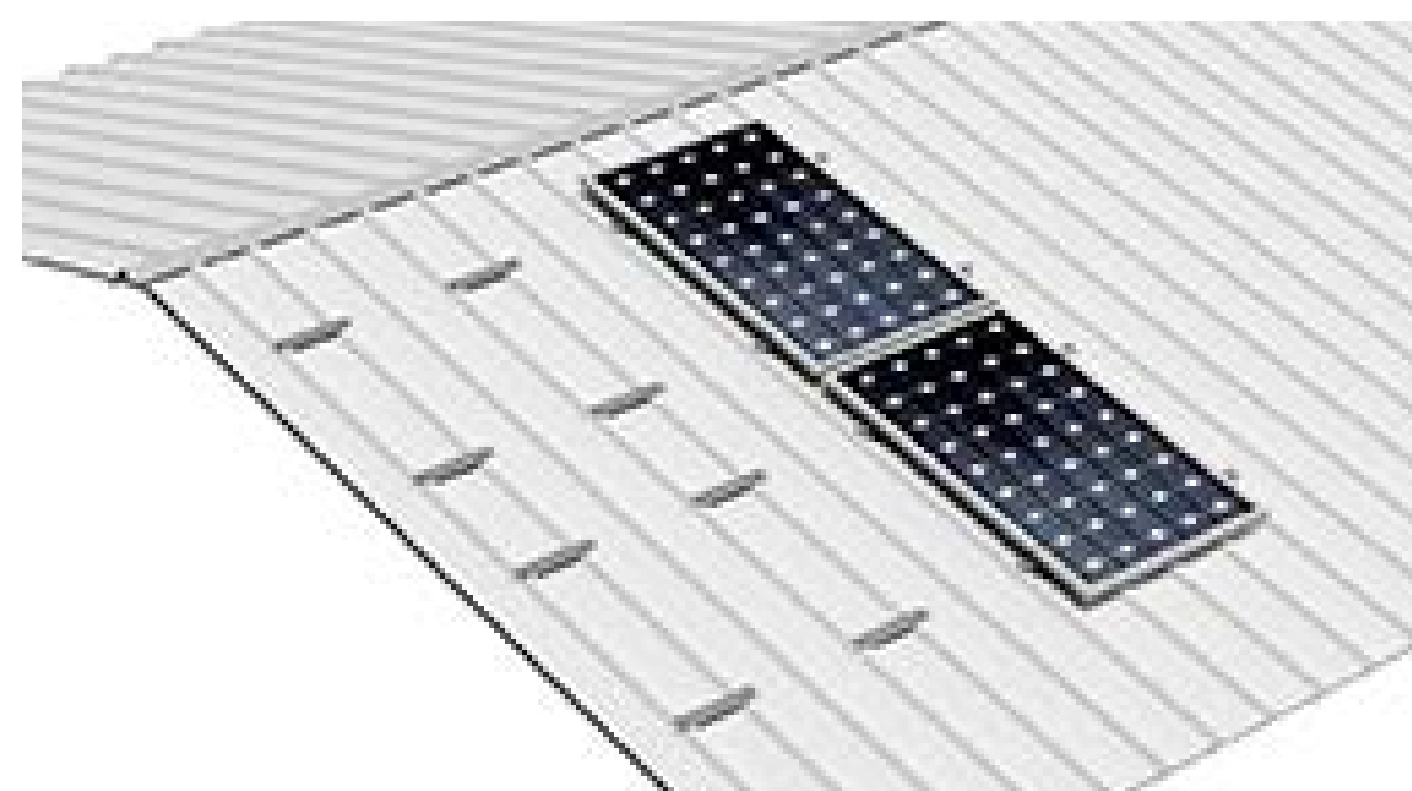
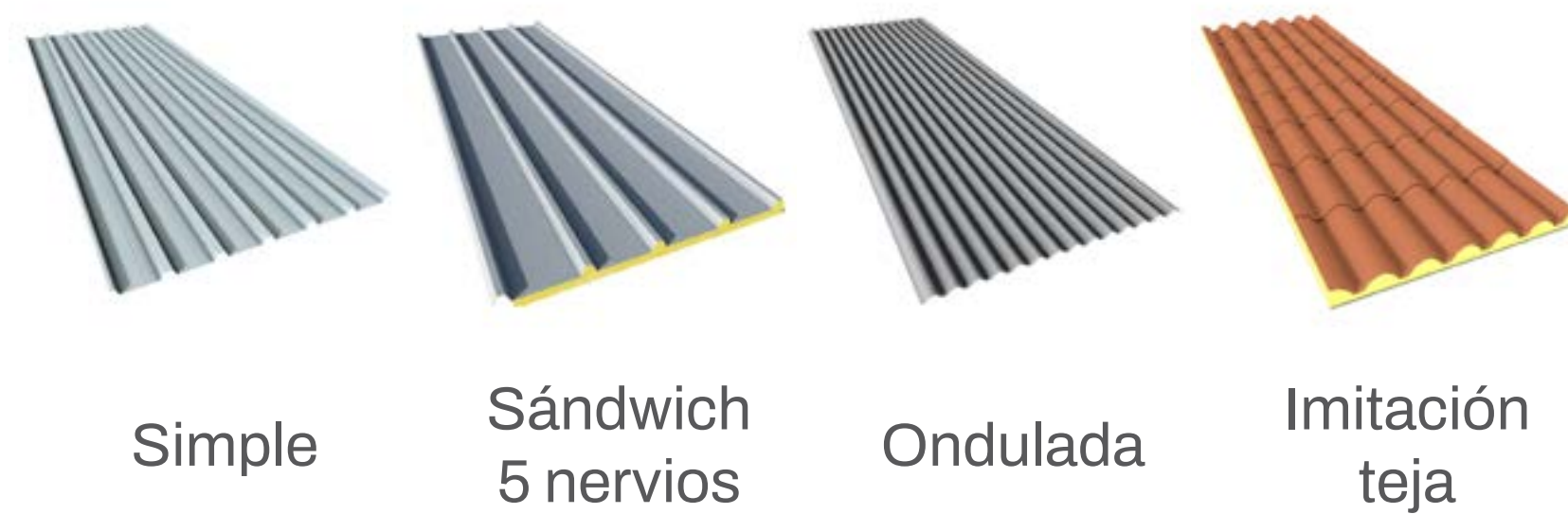

Disposición módulos vertical.

KITS

05V1

05V2

05V3

05V4

05V5

05V6

05V7

05V8

COMPONENTES DEL KIT

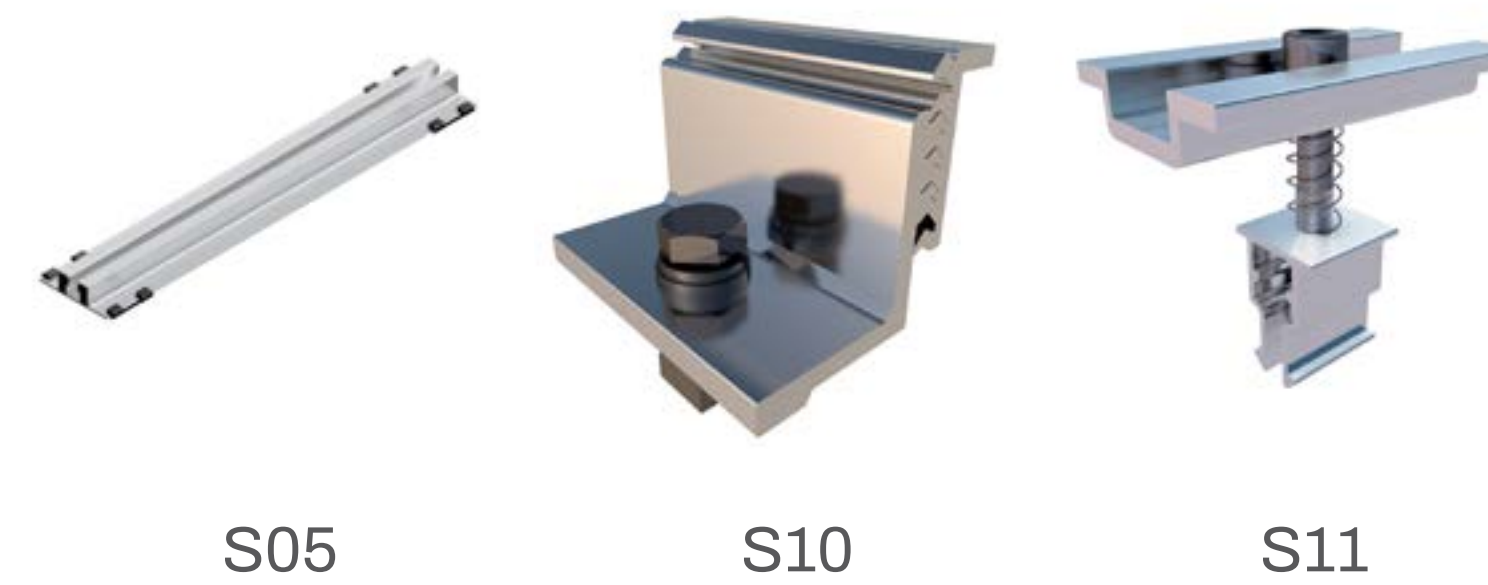

Máx.
300 mm



Mín. 0,5 mm

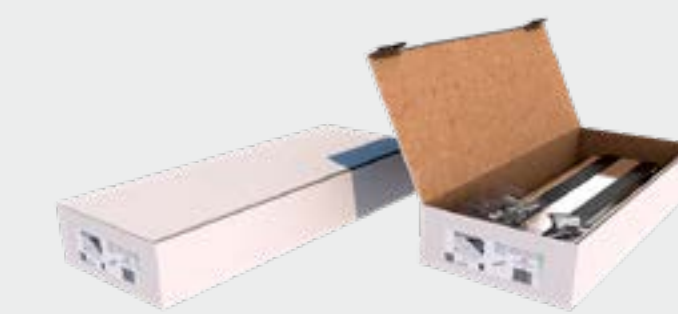

Formato Kit



Formato Bulk



Disponible en
Sunfer Project

Ver Vídeo

Ver manual de montaje

ESPECIFICACIONES

Superficie de instalación	Chapa metálica
Superficie de anclaje	Al rio de la chapa
Fijación de anclaje	Atornillada
Tornillería de anclaje	Tornillo cincado con arandela de sellado (S42.1)
Tamaño máximo del panel Kit	2400x1350 mm
Tamaño máximo del panel Bulk	2400x1350 mm
Espesor del panel	28-40 mm
Perfilería	Aluminio EN AW-6005A T6 (Crudo o anodizado)
Tornillería	General: Acero inoxidable A2-70 Anclaje: Acero cincado
Junta de estanqueidad	TPE-S de 2 mm

CHAPAS COMPATIBLES CON LA FIJACIÓN

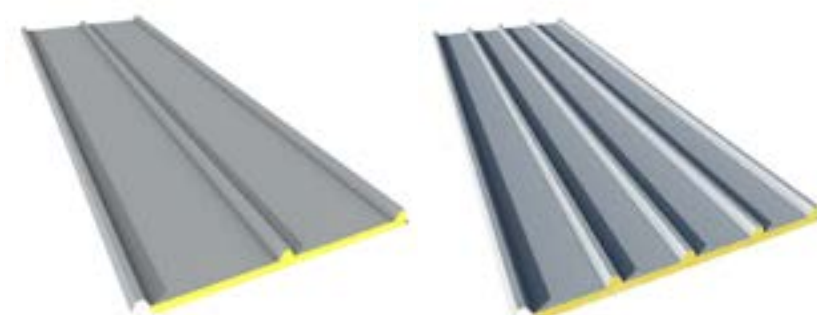

Sándwich
3 nervios

Sándwich
5 nervios

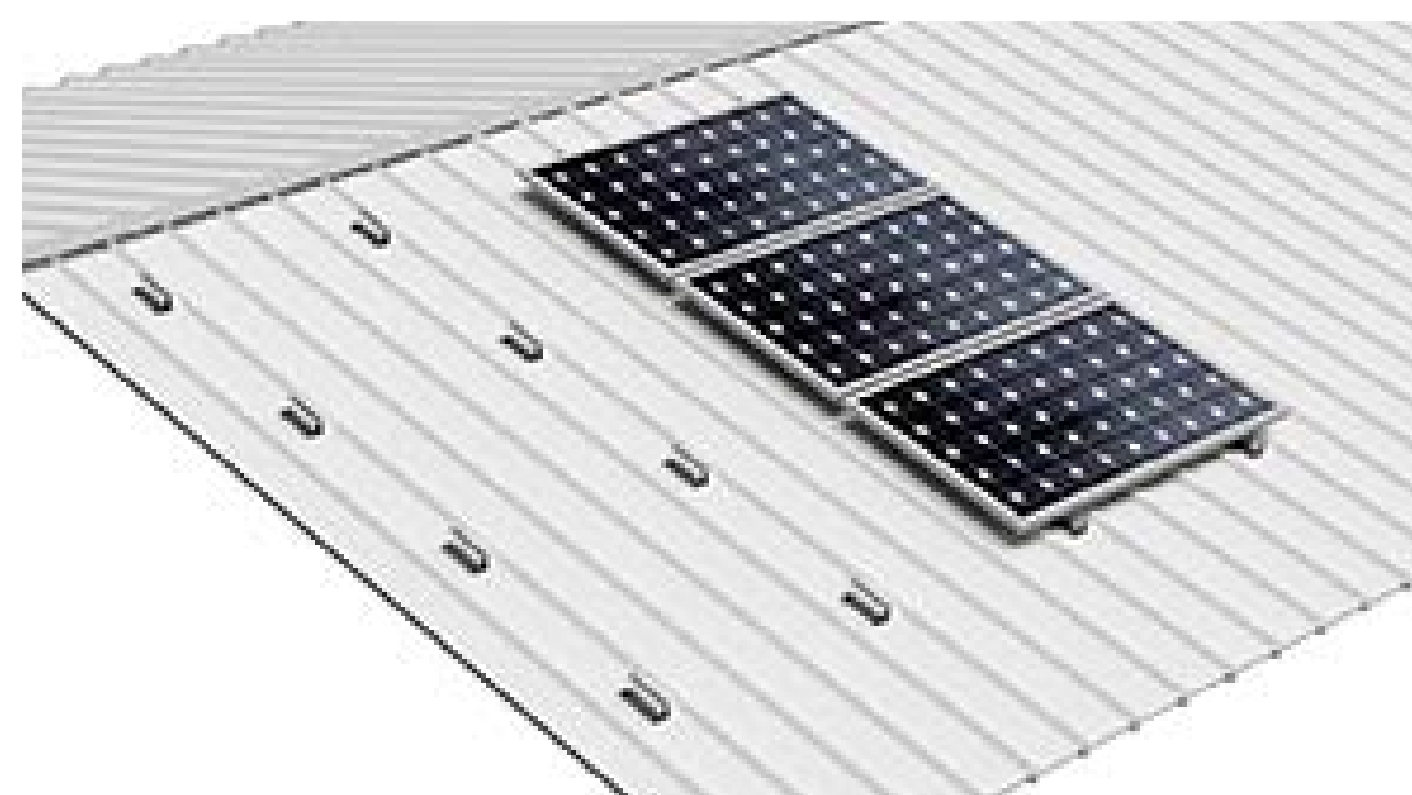

Disposición módulos horizontal.

KITS

07H1	07H2	07H3	07H4	07H5	07H6	07H7	07H8
------	------	------	------	------	------	------	------

COMPONENTES DEL KIT

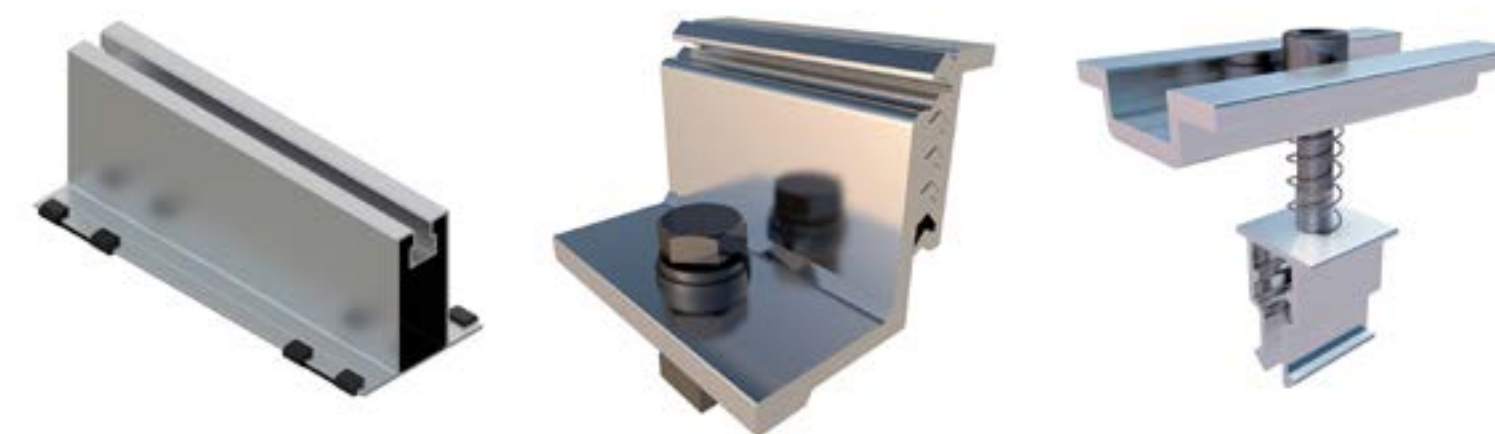

S07

S10

S11

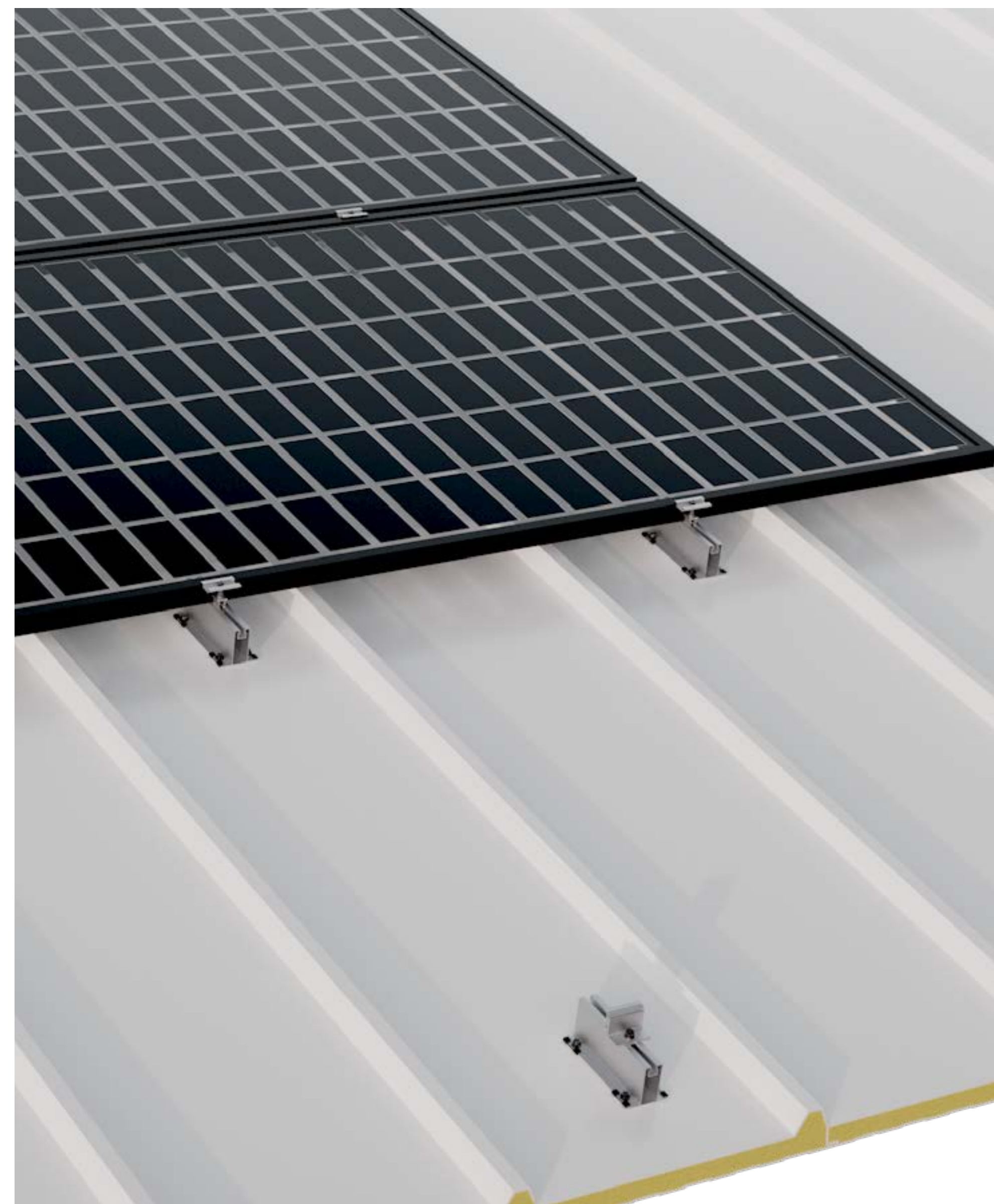

Mín. 0,5 mm



Formato Kit



Formato Bulk



Disponible en
Sunfer Project

Ver Vídeo

Ver manual de montaje

ESPECIFICACIONES

Superficie de instalación	Chapa metálica
Superficie de anclaje	Pegado a chapa
Fijación de anclaje	Cinta adhesiva
Tamaño máximo del panel Kit	2400x1350 mm
Tamaño máximo del panel Bulk	2400x1350 mm
Espesor del panel	28-40 mm
Perfilería	Aluminio EN AW-6005A T6 (Crudo o anodizado)
Tornillería	Acero inoxidable A2-70

CHAPAS COMPATIBLES CON LA FIJACIÓN



Disposición módulos horizontal.

KITS

07.1H1	07.1H2	07.1H3	07.1H4	07.1H5	07.1H6	07.1H7	07.1H8
--------	--------	--------	--------	--------	--------	--------	--------

COMPONENTES DEL KIT



Mín. 0,5 mm

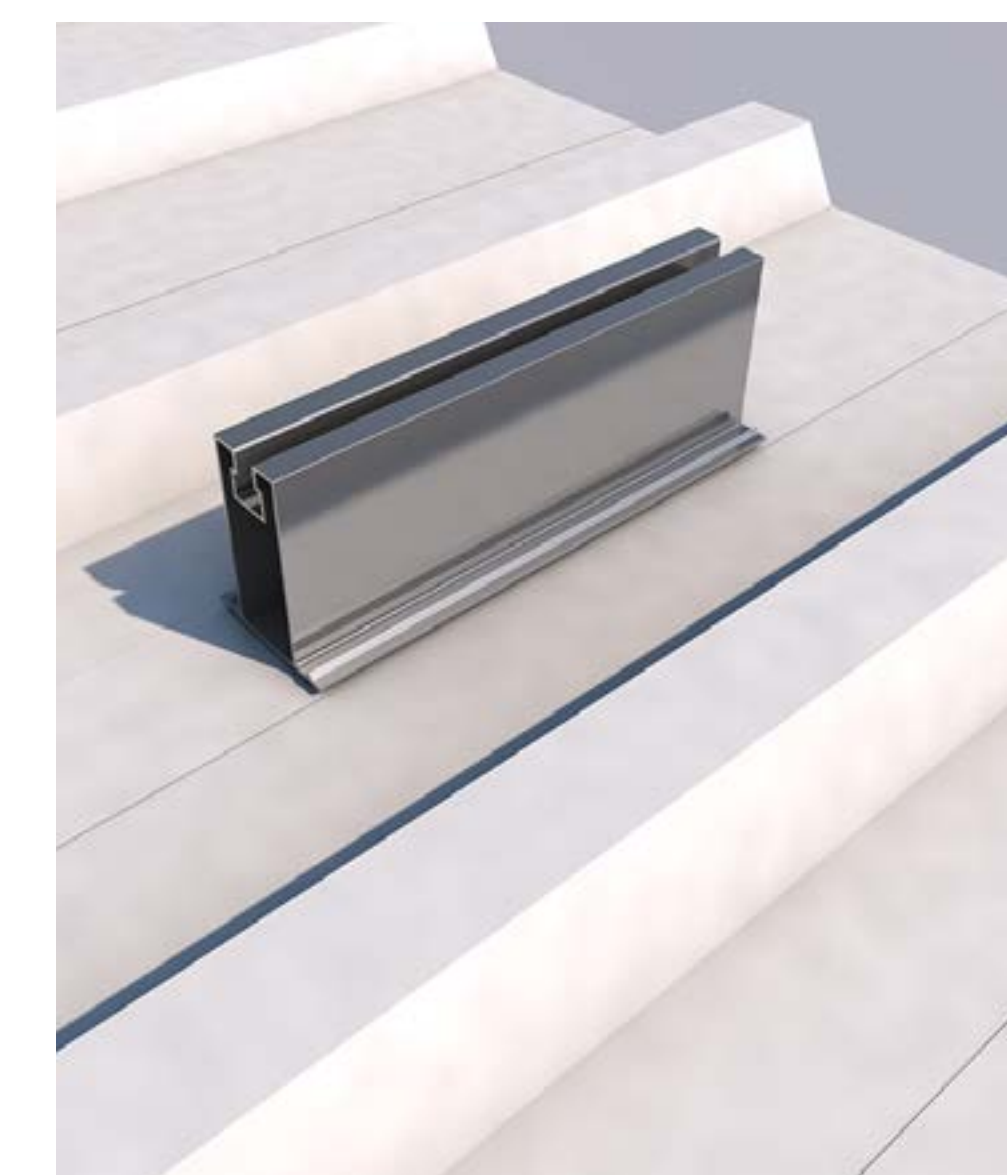

Formato Kit



Formato Bulk



Disponible en Sunfer Project

Ver Vídeo

Ver manual de montaje

ESPECIFICACIONES

Superficie de instalación	Chapa metálica
Superficie de anclaje	Anclaje a chapa
Fijación de anclaje	Atornillado
Tornillería de anclaje	Tornillo cincado con arandela de sellado (S42.1)
Tamaño máximo del panel Kit	2400x1350 mm
Tamaño máximo del panel Bulk	2400x1350 mm
Espesor del panel	28-40 mm
Perfilería	Aluminio EN AW-6005A T6 (Crudo o anodizado)
Tornillería	General: Acero inoxidable A2-70 Anclaje: Acero cincado
Junta de estanqueidad	EPDM

CHAPAS COMPATIBLES CON LA FIJACIÓN



Disposición módulos horizontal.



Disposición módulos vertical si la distancia entre miniondas es menor a 100 mm.

KITS

61H1	61H2	61H3	61H4	61H5	61H6	61H7	61H8
------	------	------	------	------	------	------	------

COMPONENTES DEL KIT

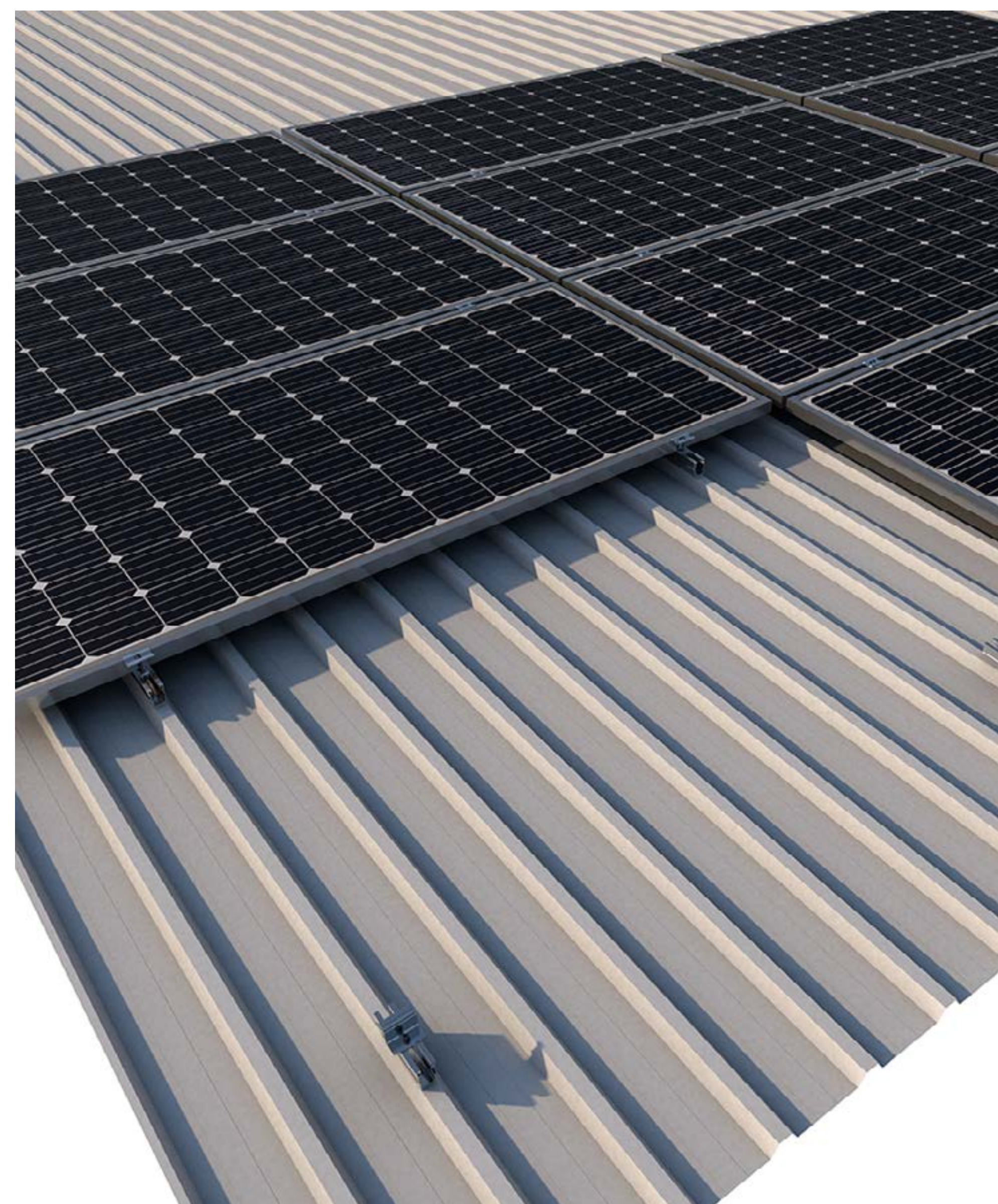

Mín. 0,5 mm

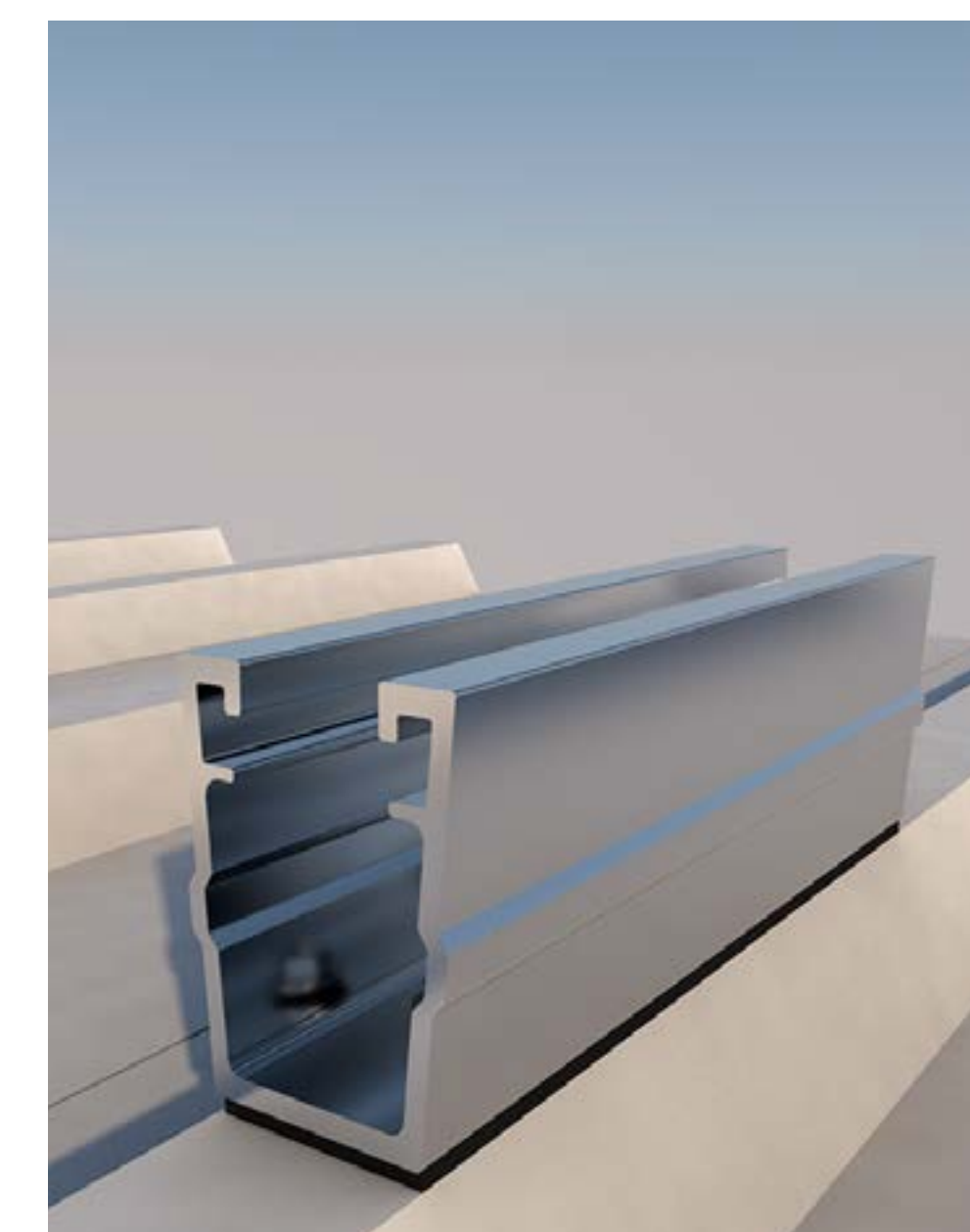

Dispone de una etiqueta en la parte inferior para facilitar el proceso de montaje.



Formato Kit



Formato Bulk



Disponible en Sunfer Project

Ver Vídeo

Ver manual de montaje

ESPECIFICACIONES

Superficie de instalación	Chapa metálica
Superficie de anclaje	Anclaje a chapa
Fijación de anclaje	Atornillado
Tornillería de anclaje	Tornillo cincado con arandela de sellado (S42.1)
Tamaño máximo del panel Kit	2400x1350 mm
Tamaño máximo del panel Bulk	2400x1350 mm
Espesor del panel	28-40 mm
Perfilería	Aluminio EN AW-6005A T6 (Crudo o anodizado)
Tornillería	General: Acero inoxidable A2-70 Anclaje: Acero cincado
Junta de estanqueidad	EPDM

CHAPAS COMPATIBLES CON LA FIJACIÓN

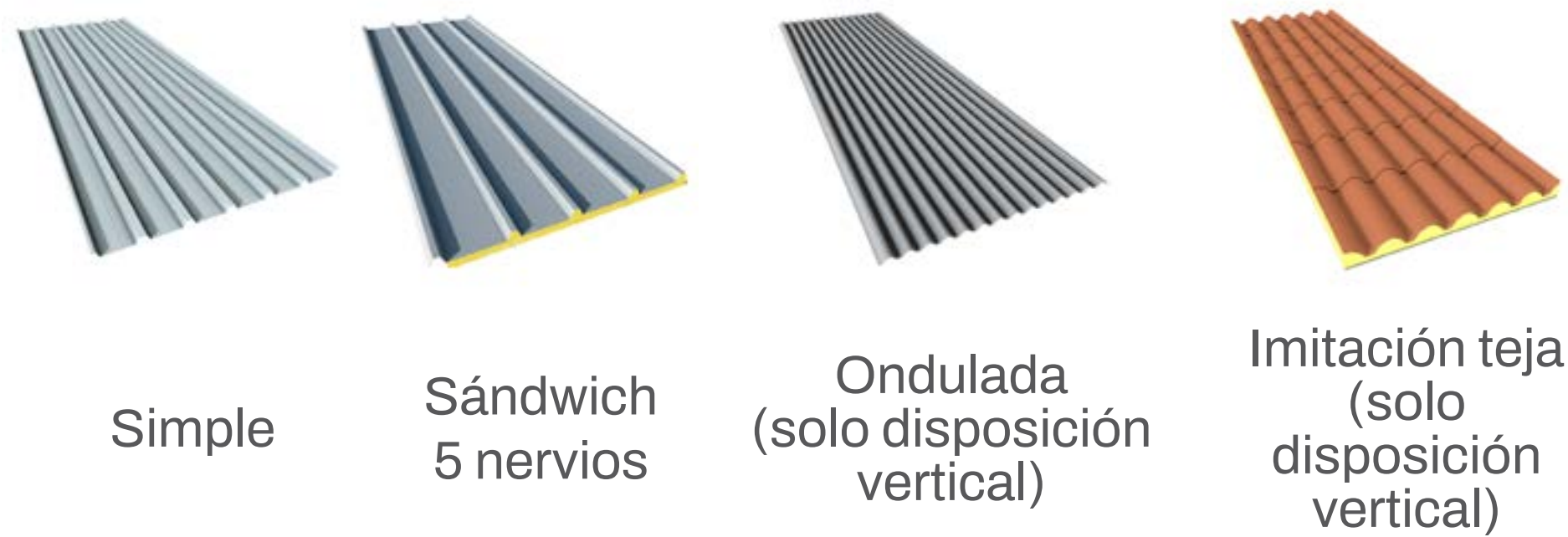

Disposición módulos vertical.

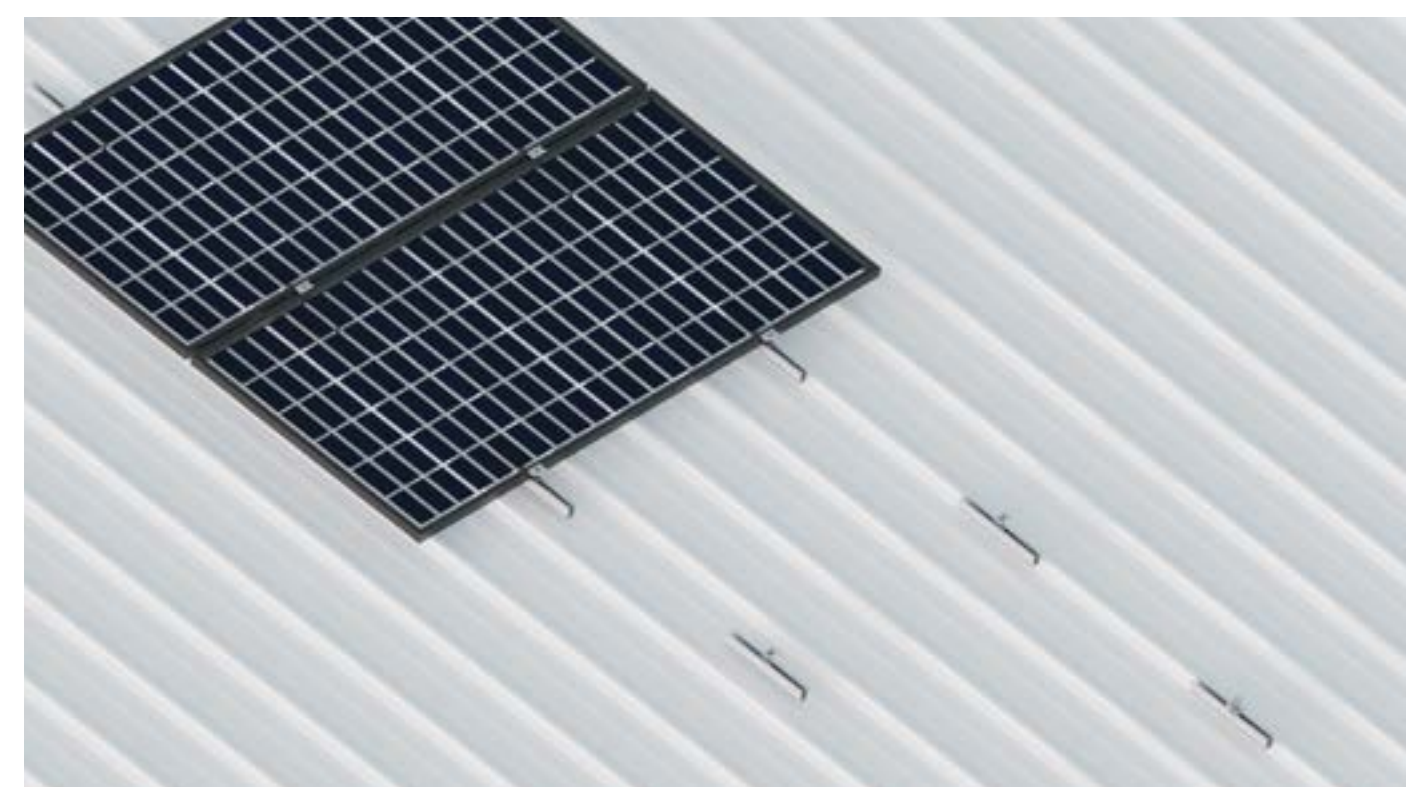

Disposición módulos horizontal.

KITS

62V1	62V2	62V3	62V4	62V5	62V6	62V7	62V8
------	------	------	------	------	------	------	------

COMPONENTES DEL KIT



Max. 333 mm



Min. ≥ 0.50 mm



Formato Kit



Formato Bulk



Disponible en Sunfer Project

Ver manual de montaje

Triángulo abierto



08V | 09V



09H



12V



14V



14.1V



19H



24H



42V

Triángulo cerrado



10V | 11V



11H



13V



20H

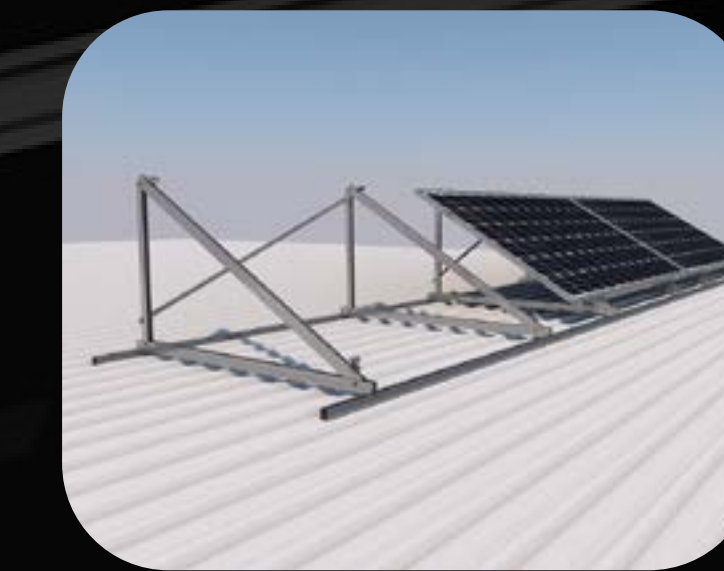

21H



25H

ESPECIFICACIONES

Superficie de instalación	Cubierta metálica o cubierta plana de hormigón	
Superficie de anclaje	Cubierta metálica: anclaje a correas o a chapa, subestructura necesaria Cubierta plana: anclaje a cubierta de hormigón o contrapeso de hormigón continuo	
Tornillería de anclaje	No incluida	
Inclinación	Estándar 15° o 30°	
Disposición del módulo	Vertical	
Tamaño máximo del panel Kit	08V: 1800x1150 mm	09V: 2279x1150 mm
Tamaño máximo del panel Bulk	08V: 1800x1350 mm	09V: 2279x1350 mm
Espesor del panel	28-40 mm	
Perfilería	Aluminio EN AW-6005A T6 (Crudo o anodizado)	
Tornillería	Acero inoxidable A2-70	



Instalación correcta de triángulo abierto sobre contrapesos de hormigón.

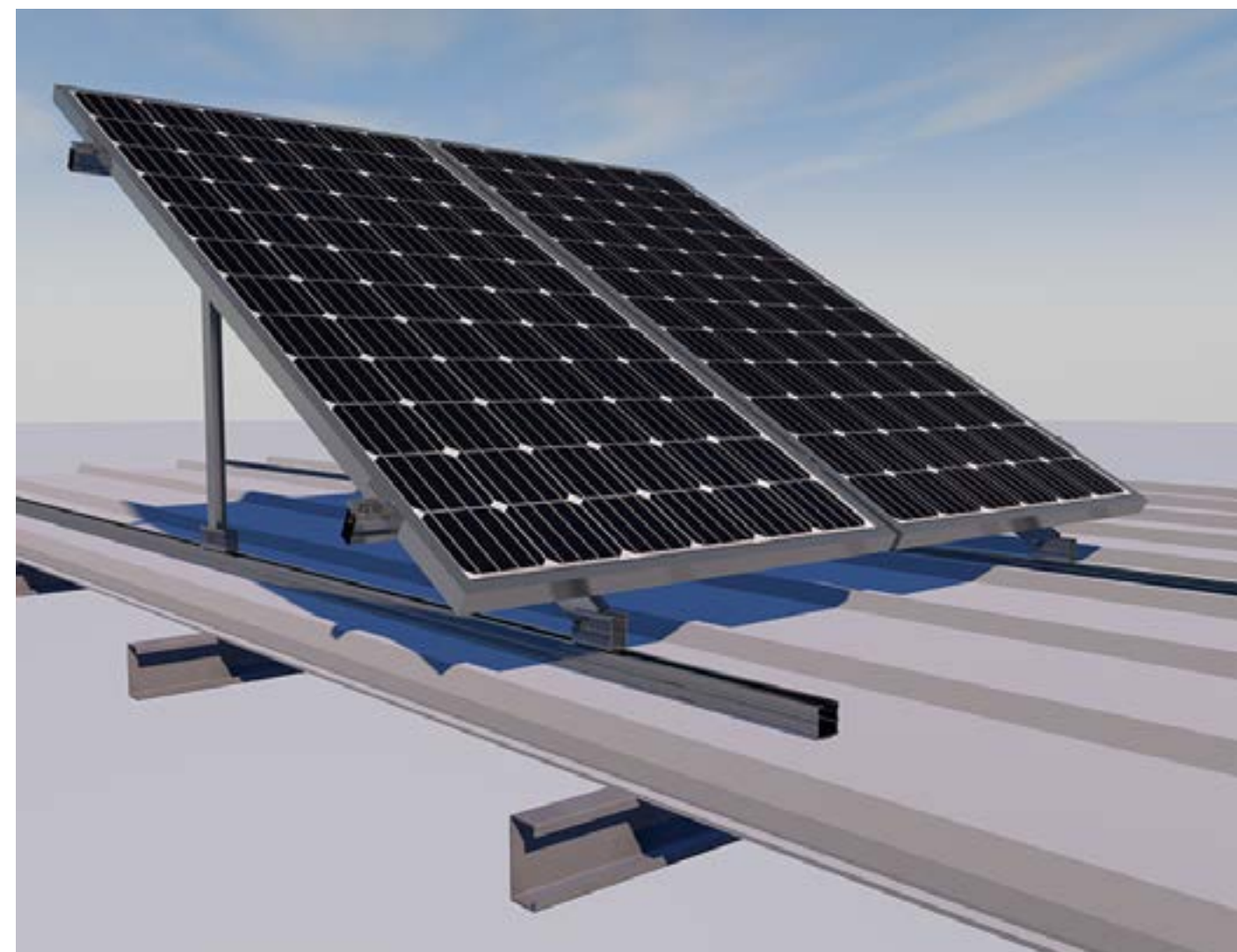

Instalación en cubierta de chapa.
Todos los puntos de anclaje del triángulo deben siempre anclarse a la correa de la cubierta.
En caso contrario se deberá colocar una subestructura.
Consultar apartado de subestructuras de este catálogo.

KITS	08V1	08V2	08V3	08V4	08V5	08V6
	09V1	09V2	09V3	09V4	09V5	09V6

SIST. UNIÓN S15

COMPONENTES DEL KIT

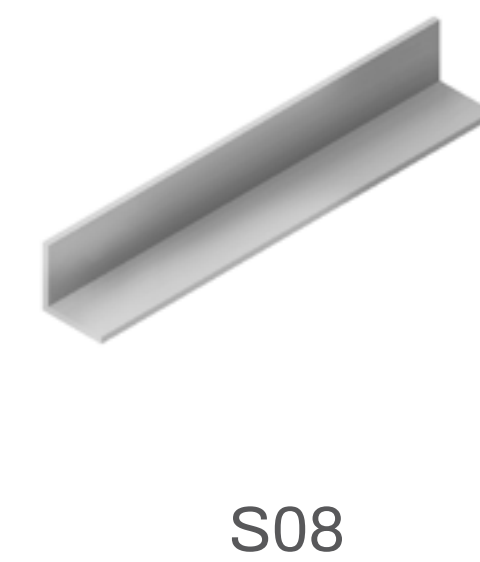
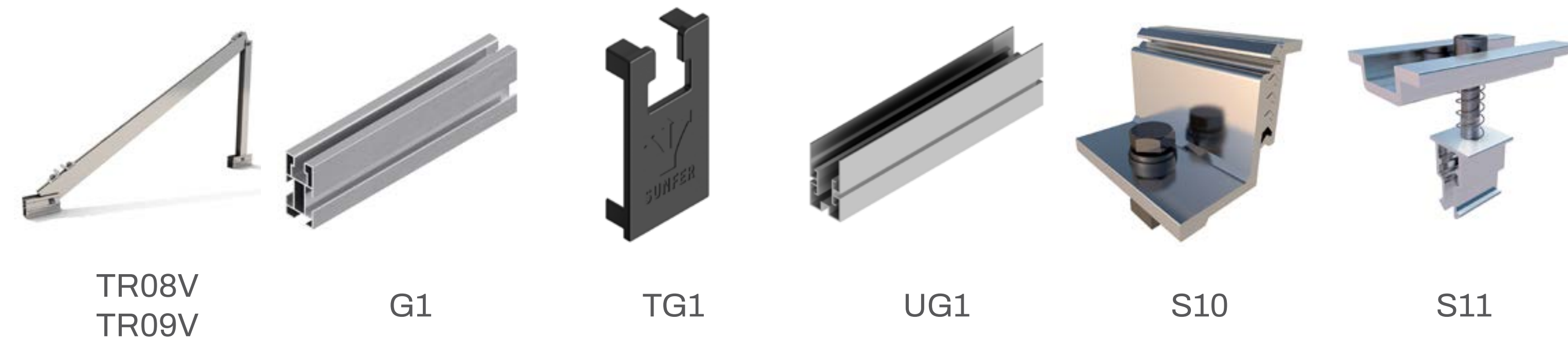

Formato Kit



Formato Bulk

[Ver Vídeo](#)

[Ver manual de montaje Kit 08V](#)

[Ver manual de montaje Kit 09V](#)

ESPECIFICACIONES

Superficie de instalación	Cubierta metálica o cubierta plana de hormigón
Superficie de anclaje	Cubierta metálica: anclaje a correas o a chapa, subestructura necesaria Cubierta plana: anclaje a cubierta de hormigón o contrapeso de hormigón continuo
Tornillería de anclaje	No incluida
Inclinación	Estándar 15° o 30°
Disposición del módulo	Horizontal
Tamaño máximo del panel Kit	2279x1150 mm
Tamaño máximo del panel Bulk	2400x1150 mm
Espesor del panel	28-40 mm
Perfilería	Aluminio EN AW-6005A T6 (Crudo o anodizado)
Tornillería	Acero inoxidable A2-70



Instalación en cubierta de chapa.

Todos los puntos de anclaje del triángulo deben siempre anclarse a la correa de la cubierta.

En caso contrario se deberá colocar una subestructura.

Consultar apartado de subestructuras de este catálogo.



Instalación correcta de triángulo abierto sobre contrapesos de hormigón.

KITS

09H1

09H2

09H3

SIST. UNIÓN

S16

COMPONENTES DEL KIT



TR09H



G1



TG1

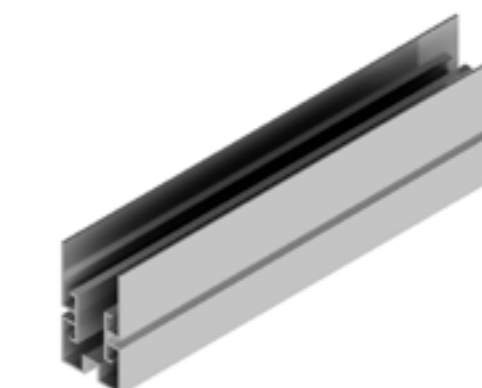

UG1

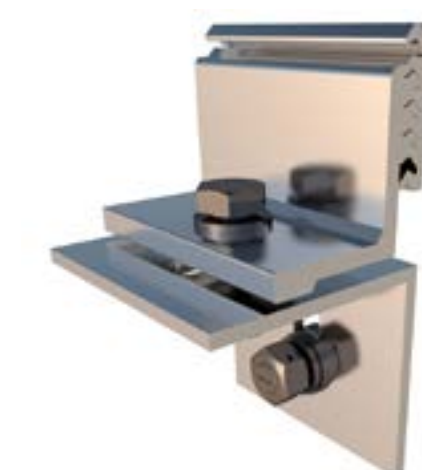

S12

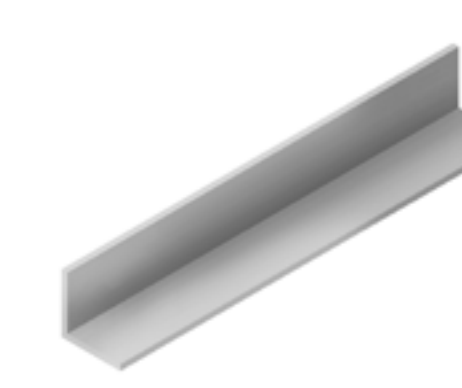

S08



Formato Kit



Formato Bulk



Disponible en Sunfer Project

[Ver Vídeo](#)

[Ver manual de montaje](#)

ESPECIFICACIONES

Superficie de instalación	Cubierta metálica o cubierta plana de hormigón
Superficie de anclaje	Cubierta metálica: anclaje a correas o a chapa, subestructura necesaria Cubierta plana: anclaje a cubierta de hormigón o contrapeso de hormigón continuo
Tornillería de anclaje	No incluida
Inclinación	Regulable de 20° a 35°
Disposición del módulo	Vertical
Tamaño máximo del panel Kit	2279x1150 mm
Tamaño máximo del panel Bulk	2279x1350 mm
Espesor del panel	28-40 mm
Perfilería	Aluminio EN AW-6005A T6 (Crudo o anodizado)
Tornillería	Acero inoxidable A2-70



Instalación correcta de triángulo abierto sobre contrapesos de hormigón.

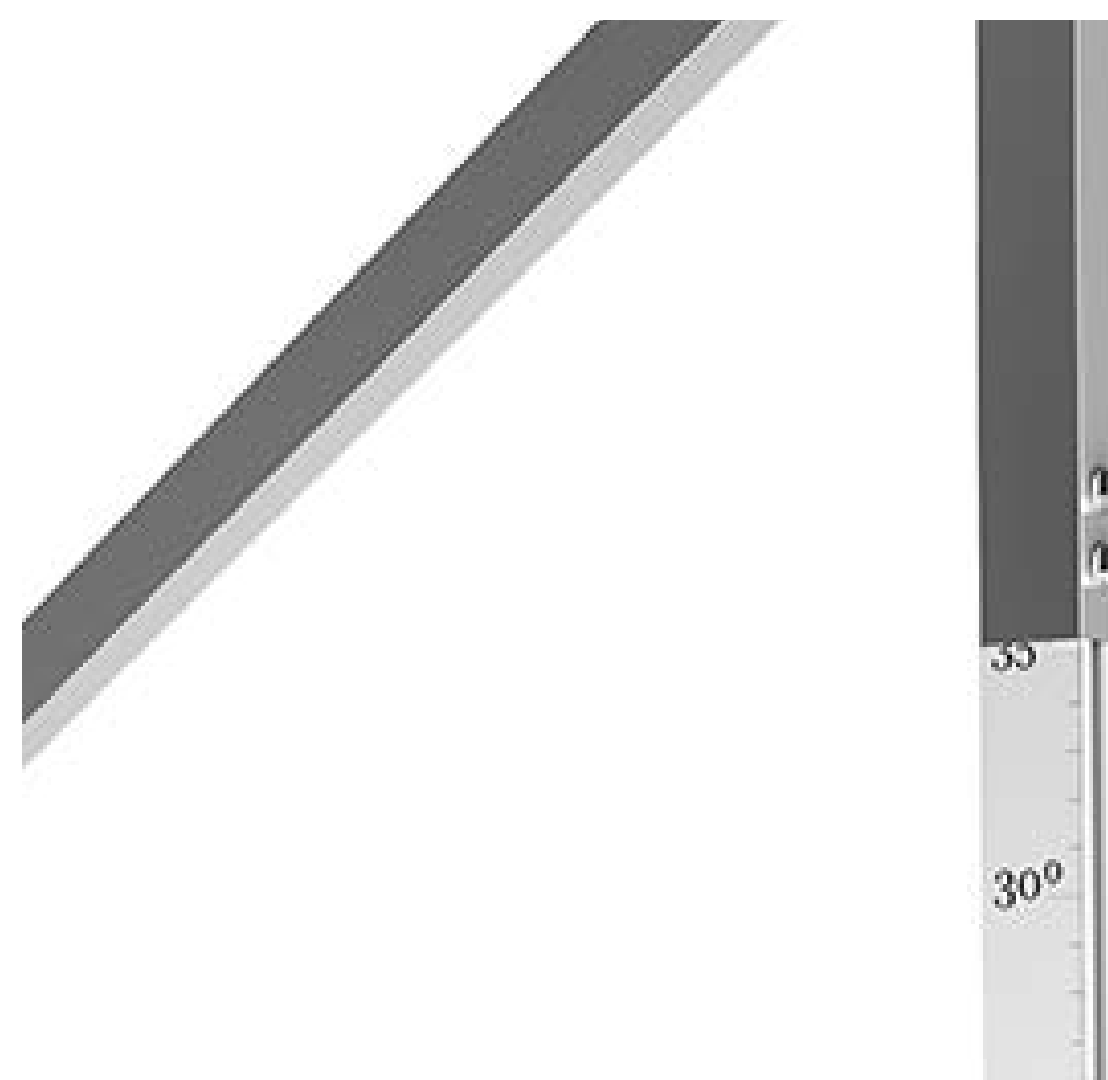

Pata extensible con marcas de regulación de ángulo de inclinación de 20° a 35°.

KITS	12V1	12V2	12V3	12V4	12V5	12V6
------	------	------	------	------	------	------

SIST. UNIÓN	S15
-------------	-----

COMPONENTES DEL KIT



Instalación en cubierta de chapa.
Todos los puntos de anclaje del triángulo deben siempre anclarse a la correa de la cubierta.
En caso contrario se deberá colocar una subestructura.
Consultar apartado de subestructuras de este catálogo.



Formato Kit



Formato Bulk

[Ver Vídeo](#)

[Ver manual de montaje](#)

Triángulo abierto

14V

ESPECIFICACIONES

Superficie de instalación	Cubierta plana
Superficie de anclaje	Cubierta plana: anclaje a cubierta de hormigón o contrapeso de hormigón continuo
Tornillería de anclaje	No incluida
Inclinación	Estándar 25° y 30° (depende posición montaje)
Disposición del módulo	Vertical
Tamaño máximo del panel Kit	2279x1150 mm
Tamaño máximo del panel Bulk	2279x1350 mm
Espesor del panel	28-40 mm
Perfilería	Aluminio EN AW-6005A T6 (Crudo o anodizado)
Tornillería	Acero inoxidable A2-70



Instalación correcta de triángulo abierto sobre contrapesos de hormigón.



KITS

14V1

14V2

14V3

SIST. UNIÓN

S17

COMPONENTES DEL KIT



TR14V



G2

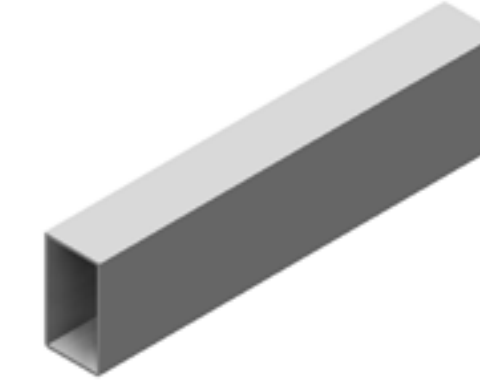

UG2/UG4

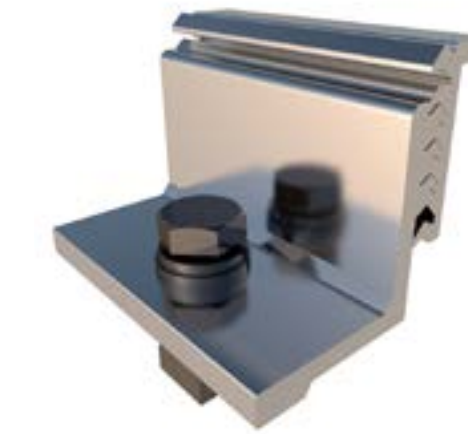

S10



S11

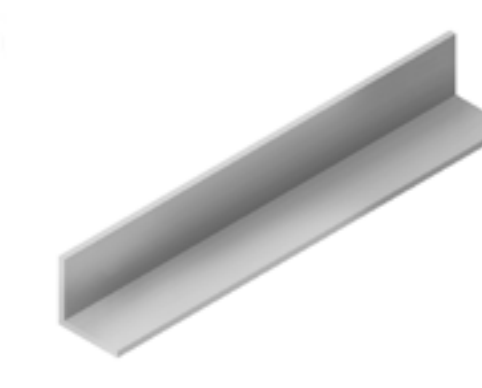

S09

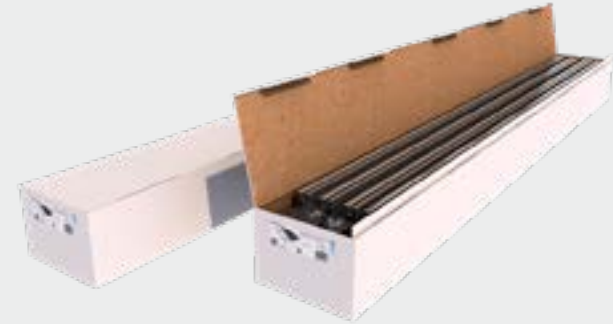

Formato Kit



Formato Bulk

[Ver Vídeo](#)

[Ver manual de montaje](#)

ESPECIFICACIONES

Superficie de instalación	Cubierta plana
Superficie de anclaje	Cubierta plana: anclaje a cubierta de hormigón o contrapeso de hormigón continuo
Tornillería de anclaje	No incluida
Inclinación	Regulable de 30° a 50°
Disposición del módulo	Vertical
Tamaño máximo del panel Kit	2279x1150 mm
Tamaño máximo del panel Bulk	2279x1350 mm
Espesor del panel	28-40 mm
Perfilería	Aluminio EN AW-6005A T6 (Crudo o anodizado)
Tornillería	Acero inoxidable A2-70



Pata extensible con marcas de regulación de ángulo de inclinación de 30° a 50°.



KITS

14.1V1

14.1V2

14.1V3

SIST. UNIÓN

S17

COMPONENTES DEL KIT



TR14.1V



G2

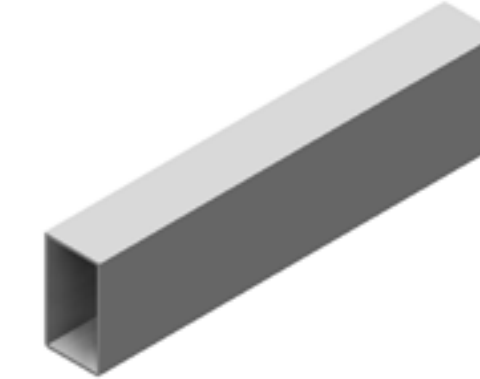

UG2/UG4

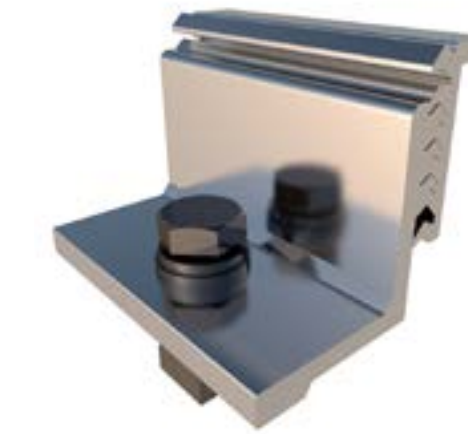

S10



S11

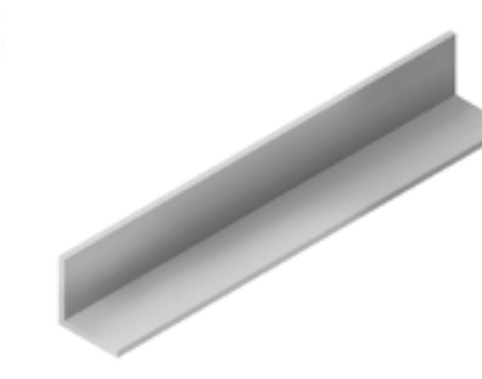

S09

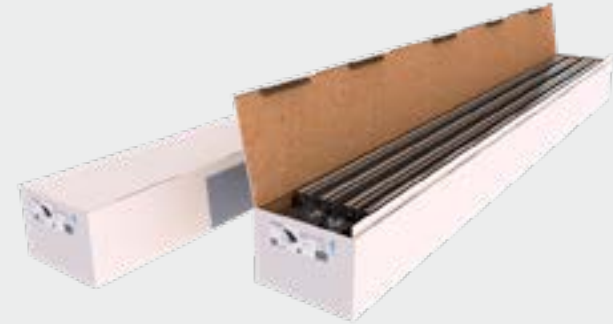

Formato Kit



Formato Bulk

[Ver Vídeo](#)

[Ver manual de montaje](#)

ESPECIFICACIONES

Superficie de instalación	Cubierta metálica o cubierta plana de hormigón
Superficie de anclaje	Cubierta metálica: anclaje a correas o a chapa, subestructura necesaria Cubierta plana: anclaje a cubierta de hormigón o contrapeso de hormigón continuo
Tornillería de anclaje	No incluida
Inclinación	Estándar 15° o 30°
Disposición del módulo	Horizontal
Tamaño máximo del panel Kit	2400x1150 mm
Tamaño máximo del panel Bulk	2400x1150 mm
Espesor del panel	28-40 mm
Perfilería	Aluminio EN AW-6005A T6 (Crudo o anodizado)
Tornillería	Acero inoxidable A2-70

KITS

19H1

COMPONENTES DEL KIT

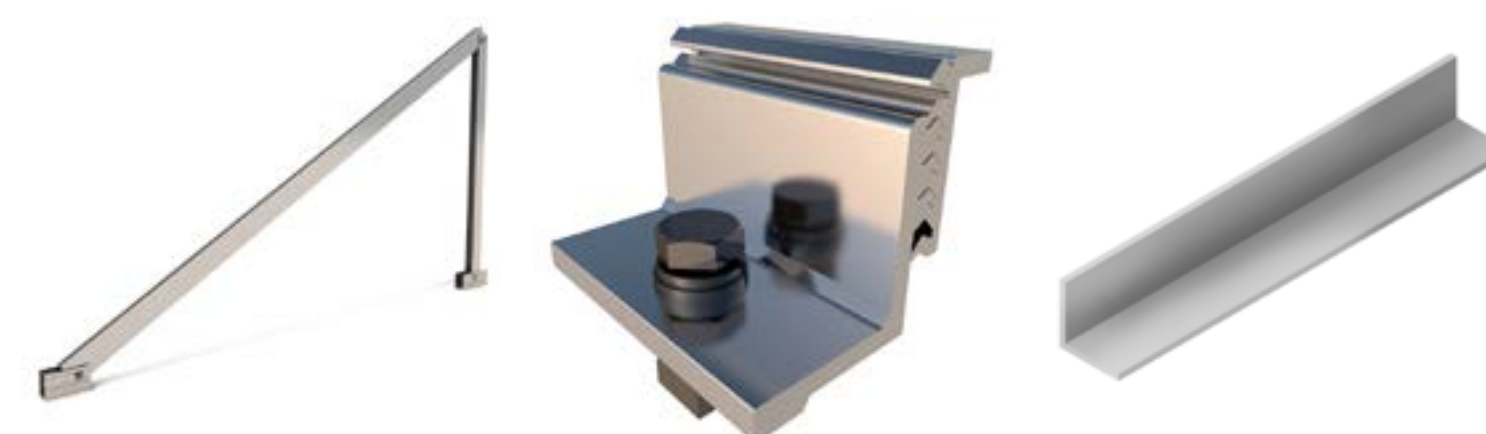

TR19H

S10

S08



Formato Kit



Formato Bulk

[Ver Vídeo](#)

[Ver manual de montaje](#)



Estructura para un módulo sin necesidad de perfil guía.

Instalación en cubierta de chapa.

Todos los puntos de anclaje del triángulo deben siempre anclarse a la correa de la cubierta.

En caso contrario se deberá colocar una subestructura.

Consultar apartado de subestructuras de este catálogo.



ESPECIFICACIONES

Superficie de instalación	Cubierta metálica o cubierta plana de hormigón
Superficie de anclaje	Cubierta metálica: anclaje a correas o a chapa, subestructura necesaria Cubierta plana: anclaje a cubierta de hormigón o contrapeso de hormigón continuo
Tornillería de anclaje	No incluida
Inclinación	Estándar 15° o 30°
Disposición del módulo	Horizontal
Tamaño máximo del panel Kit	2279x1150 mm
Espesor del panel	28-40 mm
Perfilería	Aluminio EN AW-6005A T6 (Crudo o anodizado)
Tornillería	Acero inoxidable A2-70

KITS 24H2

COMPONENTES DEL KIT

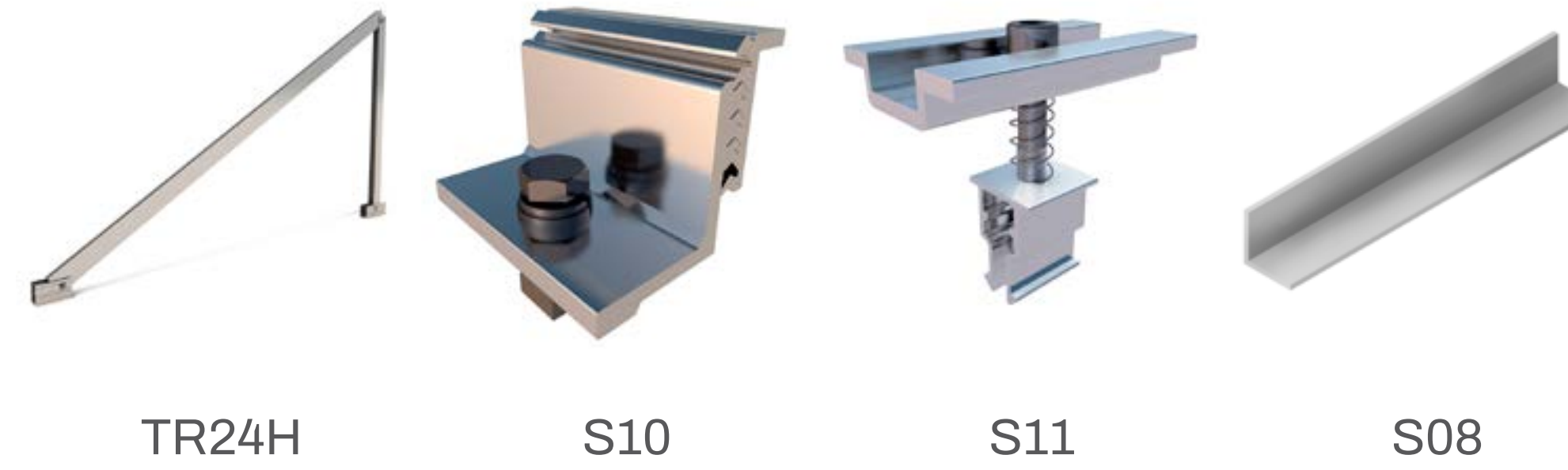

Instalación en cubierta de chapa.
 Todos los puntos de anclaje del triángulo deben siempre anclarse a la correa de la cubierta.
 En caso contrario se deberá colocar una subestructura.
 Consultar apartado de subestructuras de este catálogo.



Formato Kit

[Ver manual de montaje](#)

ESPECIFICACIONES

Superficie de instalación	Cubierta plana
Superficie de anclaje	Anclaje a cubierta de hormigón
Tornillería de anclaje	No incluida
Inclinación	Estándar 15° o 30°
Disposición del módulo	Vertical
Tamaño máximo del panel Kit	2279x1150 mm
Tamaño máximo del panel Bulk	2279x1350 mm
Espesor del panel	28-40 mm
Perfilería	Aluminio EN AW-6005A T6 (Crudo o anodizado)
Tornillería	Acero inoxidable A2-70



⚠ Este soporte no acepta lastres.

KITS

42V2

42V4

42V6

SIST. UNIÓN

S15.2

COMPONENTES DEL KIT



TR42



G1



TG1

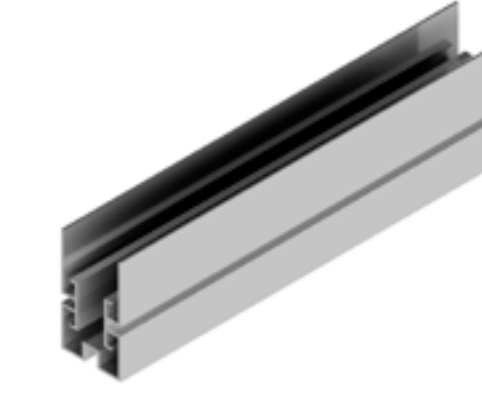

UG1

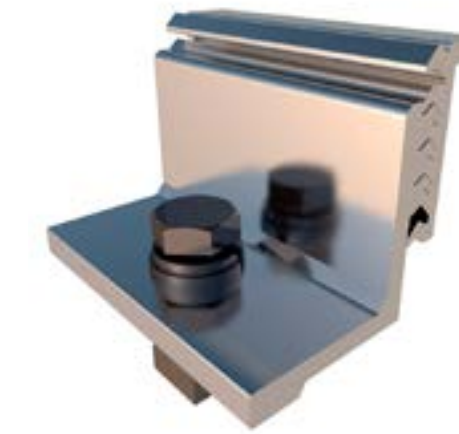

S10



S11

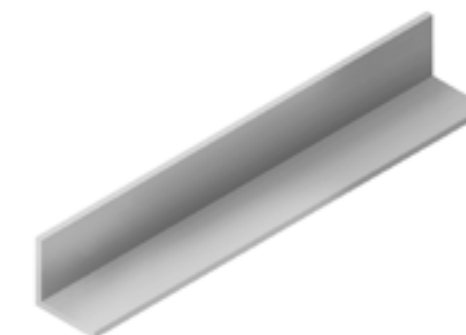

S08



Formato Kit



Formato Bulk

[Ver Vídeo](#)

[Ver manual de montaje](#)

Triángulo cerrado

10V - 11V

ESPECIFICACIONES

Superficie de instalación	Cubierta metálica o cubierta plana de hormigón	
Superficie de anclaje	Cubierta metálica: anclaje a correas o a chapa, subestructura necesaria Cubierta plana: anclaje a cubierta de hormigón o contrapeso de hormigón	
Tornillería de anclaje	No incluida	
Inclinación	Estándar 15° o 30°	
Disposición del módulo	Vertical	
Tamaño máximo del panel Kit	10V: 1800x1150 mm	11V: 2279x1150 mm
Tamaño máximo del panel Bulk	10V: 1800x1350 mm	11V: 2279x1350 mm
Espesor del panel	28-40 mm	
Perfilería	Aluminio EN AW-6005A T6 (Crudo o anodizado)	
Tornillería	Acero inoxidable A2-70	



Instalación correcta de triángulo abierto sobre contrapesos de hormigón.

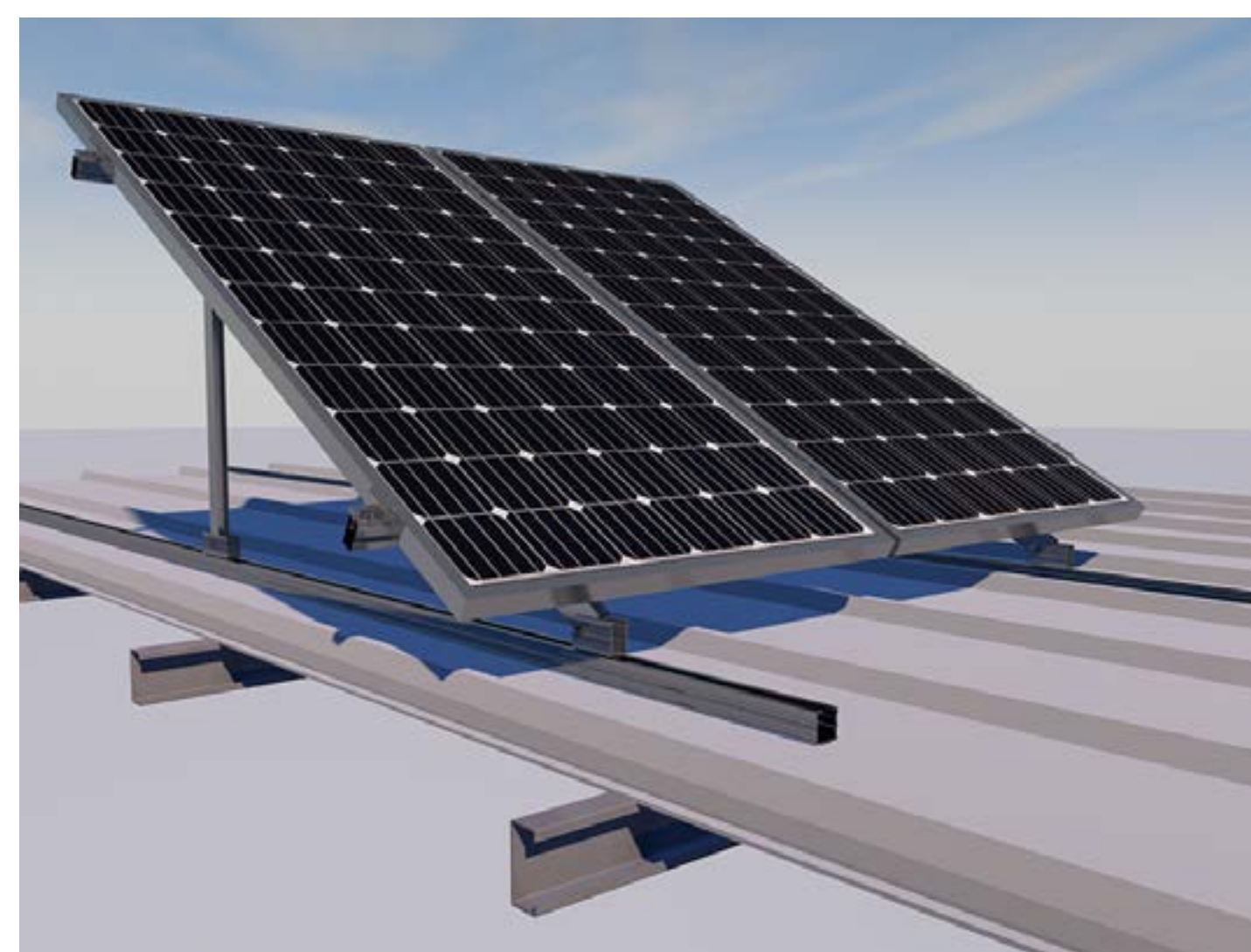

Instalación en cubierta de chapa. Todos los puntos de anclaje del triángulo deben siempre anclarse a la correa de la cubierta. En caso contrario se deberá colocar una subestructura. Consultar apartado de subestructuras de este catálogo.

KITS	10V1	10V2	10V3	10V4	10V5	10V6
	11V1	11V2	11V3	11V4	11V5	11V6

SIST. UNIÓN S15

COMPONENTES DEL KIT

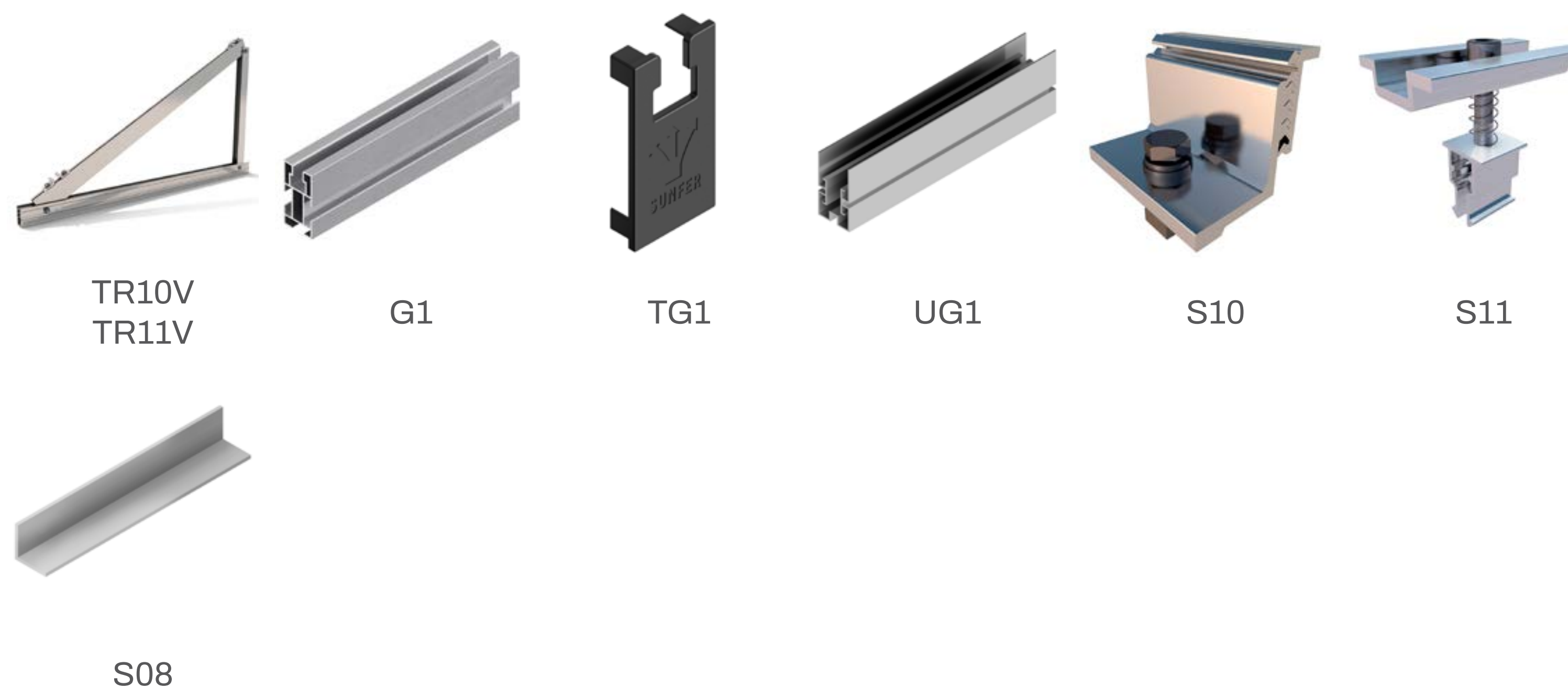

Formato Kit



Formato Bulk

[Ver Vídeo](#)

[Ver manual de montaje 10V](#)

[Ver manual de montaje 11V](#)

Triángulo cerrado

11H

ESPECIFICACIONES

Superficie de instalación	Cubierta metálica o cubierta plana de hormigón
Superficie de anclaje	Cubierta metálica: anclaje a correas o a chapa, subestructura necesaria Cubierta plana: anclaje a cubierta de hormigón o contrapeso de hormigón
Tornillería de anclaje	No incluida
Inclinación	Estándar 15° o 30°
Disposición del módulo	Horizontal
Tamaño máximo del panel Kit	2279x1150 mm
Tamaño máximo del panel Bulk	2400x1150 mm
Espesor del panel	28-40 mm
Perfilería	Aluminio EN AW-6005A T6 (Crudo o anodizado)
Tornillería	Acero inoxidable A2-70



Instalación en cubierta de chapa.

Todos los puntos de anclaje del triángulo deben siempre anclarse a la correa de la cubierta.

En caso contrario se deberá colocar una subestructura.

Consultar apartado de subestructuras de este catálogo.

KITS

11H1

11H2

11H3

SIST. UNIÓN

S16

COMPONENTES DEL KIT

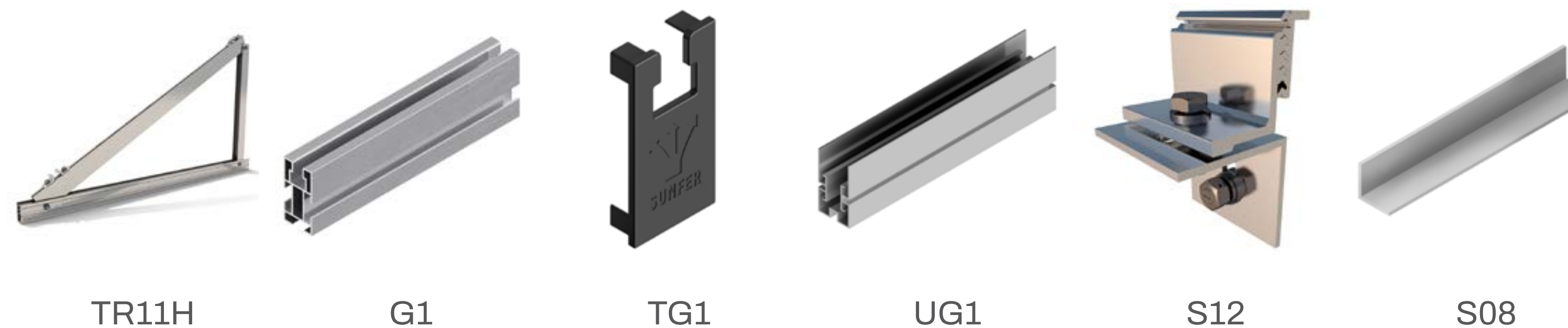

Formato Kit



Formato Bulk



Disponible en Sunfer Project

[Ver Vídeo](#)

[Ver manual de montaje](#)

Triángulo cerrado

13V

ESPECIFICACIONES

Superficie de instalación	Cubierta metálica o cubierta plana de hormigón
Superficie de anclaje	Cubierta metálica: anclaje a correas o a chapa, subestructura necesaria Cubierta plana: anclaje a cubierta de hormigón o contrapeso de hormigón
Tornillería de anclaje	No incluida
Inclinación	Regulable de 20° a 35°
Disposición del módulo	Vertical
Tamaño máximo del panel Kit	2279x1150 mm
Tamaño máximo del panel Bulk	2279x1350 mm
Espesor del panel	28-40 mm
Perfilería	Aluminio EN AW-6005A T6 (Crudo o anodizado)
Tornillería	Acero inoxidable A2-70

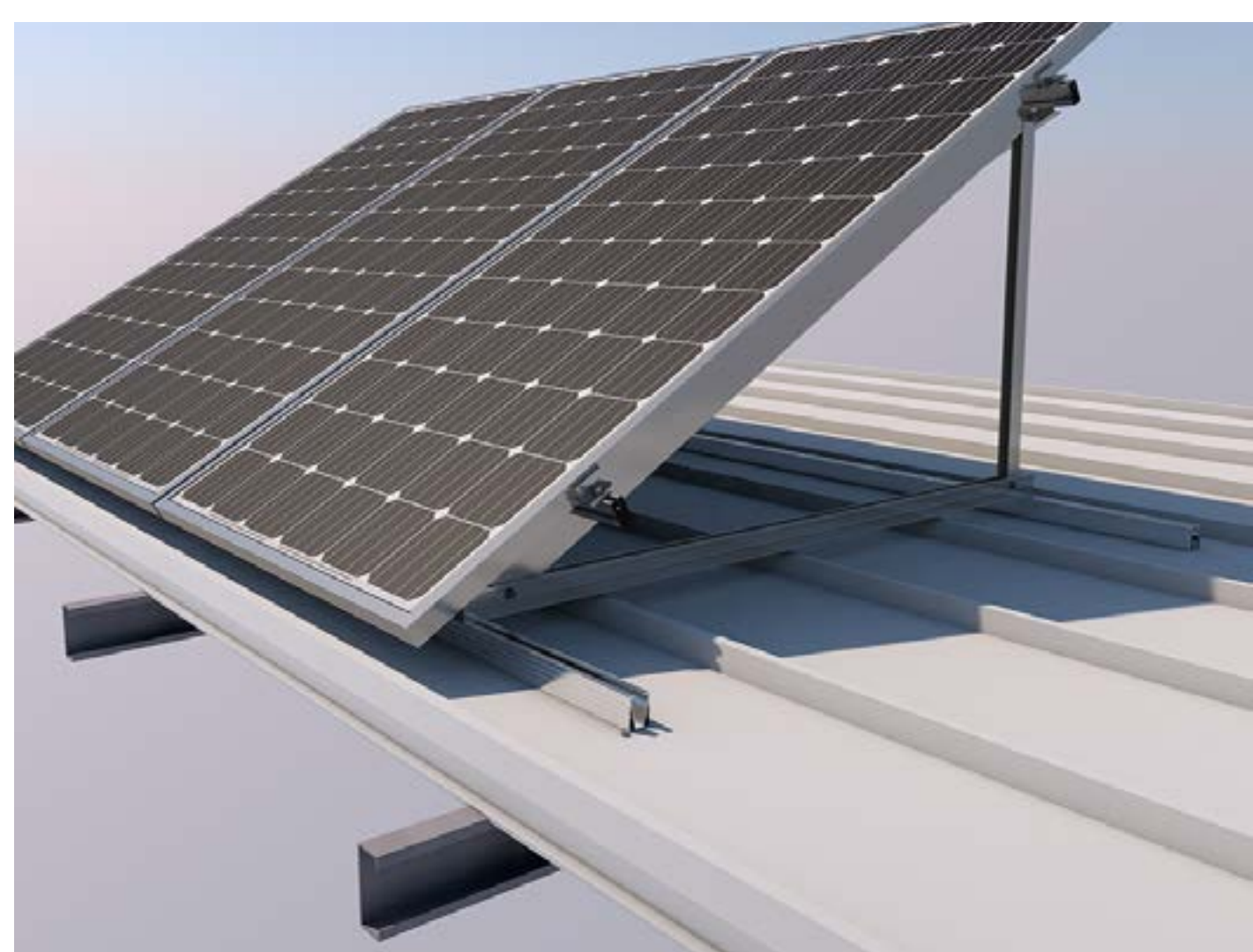

Instalación en cubierta de chapa.

Todos los puntos de anclaje del triángulo deben siempre anclarse a la correa de la cubierta.

En caso contrario se deberá colocar una subestructura.

Consultar apartado de subestructuras de este catálogo.



Pata extensible con marcas de regulación de ángulo de inclinación de 20° a 35°.

KITS	13V1	13V2	13V3	13V4	13V5	13V6
------	------	------	------	------	------	------

SIST. UNIÓN	S15
-------------	-----

COMPONENTES DEL KIT

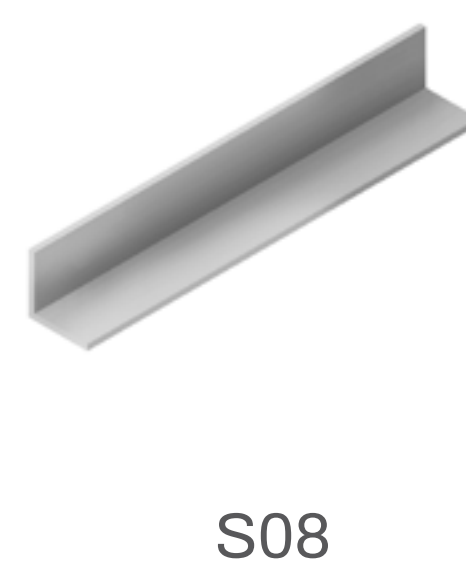
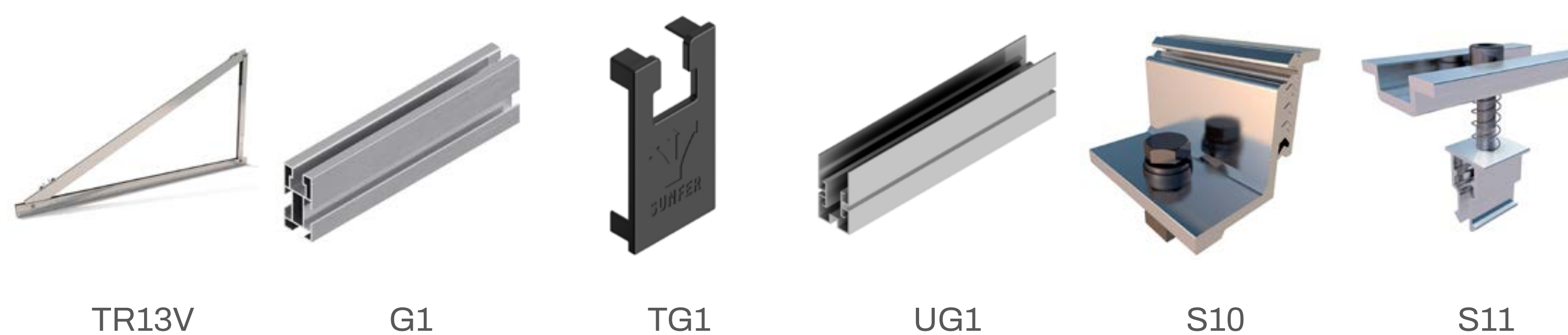

Formato Kit



Formato Bulk

[Ver Vídeo](#)

[Ver manual de montaje](#)

ESPECIFICACIONES

Superficie de instalación	Cubierta metálica o cubierta plana de hormigón
Superficie de anclaje	Cubierta metálica: anclaje a correas o a chapa, subestructura necesaria Cubierta plana: anclaje a cubierta de hormigón o contrapeso de hormigón
Tornillería de anclaje	No incluida
Inclinación	Estándar 15° o 30°
Disposición del módulo	Horizontal
Tamaño máximo del panel Kit	2400x1150 mm
Tamaño máximo del panel Bulk	2400x1150 mm
Espesor del panel	28-40 mm
Perfilería	Aluminio EN AW-6005A T6 (Crudo o anodizado)
Tornillería	Acero inoxidable A2-70

KITS

20H1

COMPONENTES DEL KIT

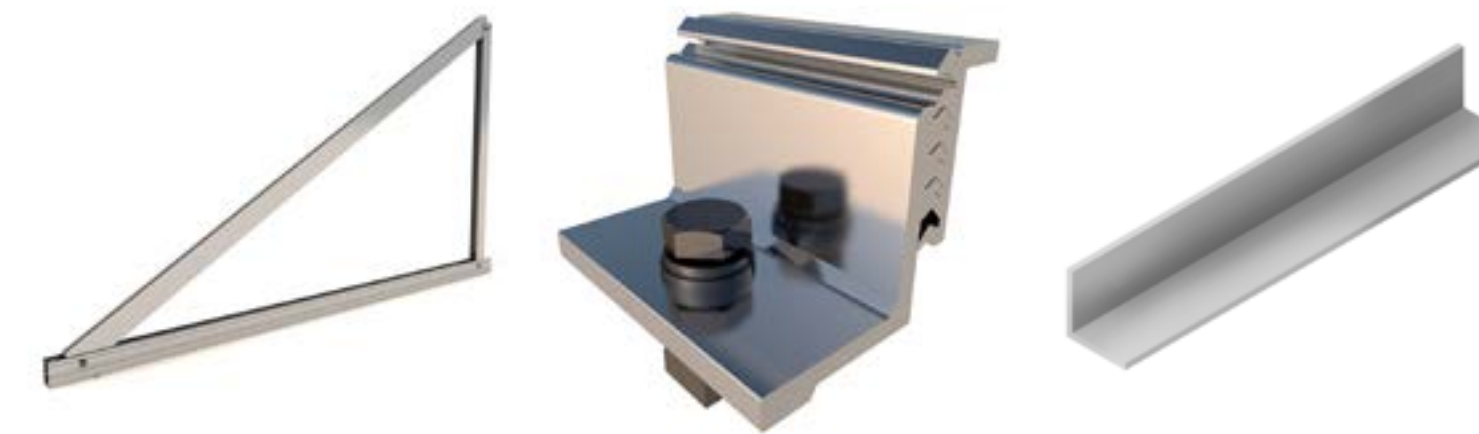

TR20H

S10

S08



Estructura para un módulo sin necesidad de perfil guía.

Instalación en cubierta de chapa.
Todos los puntos de anclaje del triángulo deben siempre anclarse a la correa de la cubierta.
En caso contrario se deberá colocar una subestructura.
Consultar apartado de subestructuras de este catálogo.



Formato Kit



Formato Bulk

[Ver Vídeo](#)

[Ver manual de montaje](#)

ESPECIFICACIONES

Superficie de instalación	Cubierta metálica
Superficie de anclaje	Anclaje a correas con subestructura incluida
Tornillería de anclaje	No incluida
Inclinación	Estándar 15° o 30°
Disposición del módulo	Horizontal
Tamaño máximo del panel Kit	2279x1150 mm
Tamaño máximo del panel Bulk	2279x1150 mm
Espesor del panel	28-40 mm
Perfilería	Aluminio EN AW-6005A T6 (Crudo o anodizado)
Tornillería	Acero inoxidable A2-70

KITS

21H1

21H2

21H3

COMPONENTES DEL KIT

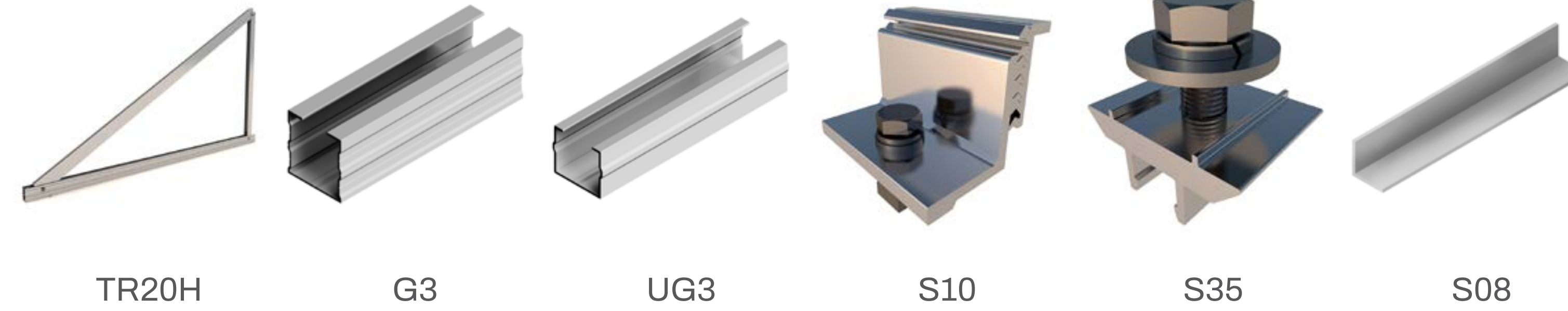

Formato Kit



Formato Bulk

[Ver Vídeo](#)

[Ver manual de montaje](#)

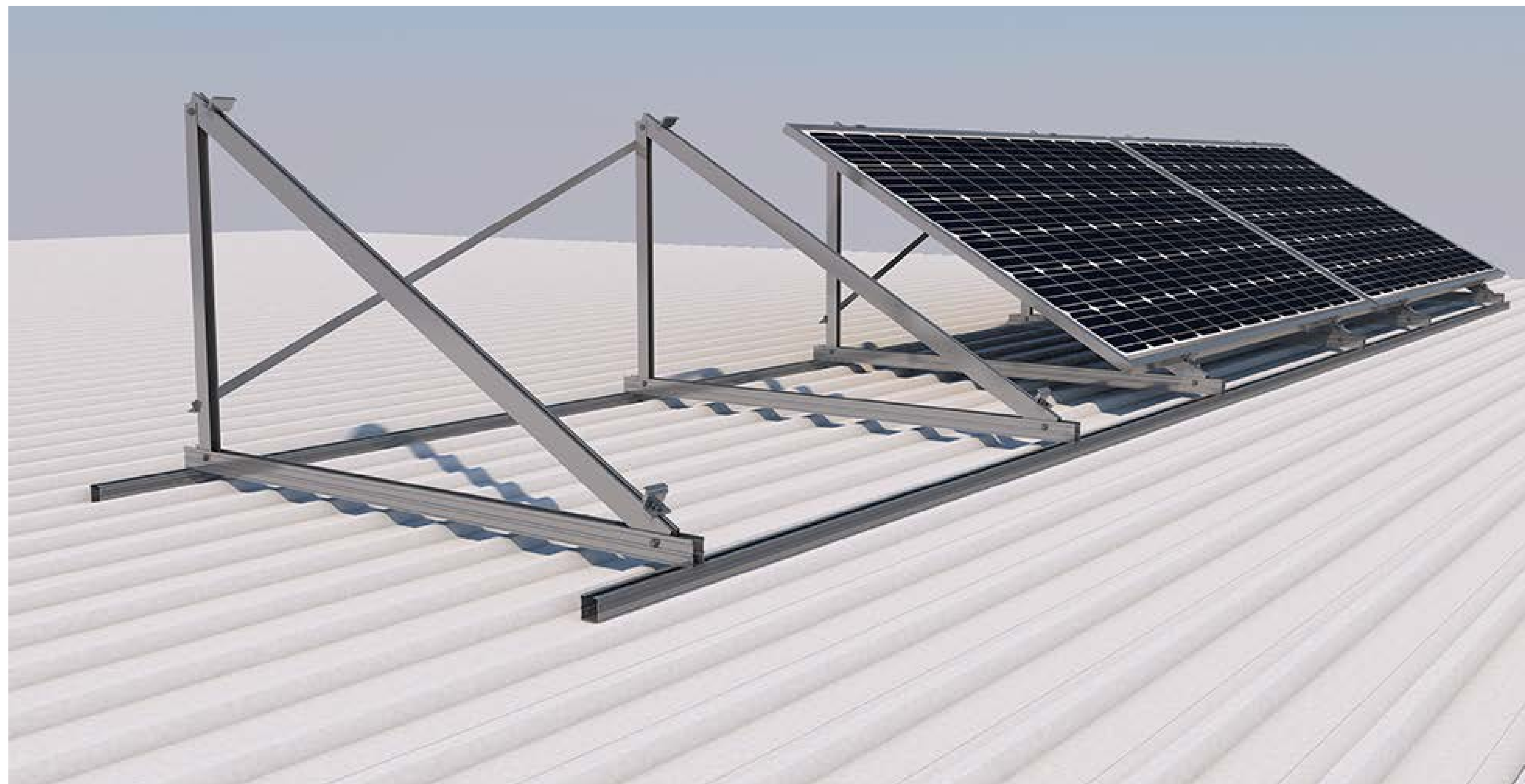

Estructura para un módulo sin necesidad de perfil guía. El Kit incluye la subestructura.



ESPECIFICACIONES

Superficie de instalación	Cubierta metálica o cubierta plana de hormigón
Superficie de anclaje	Cubierta metálica: anclaje a correas o a chapa, subestructura necesaria Cubierta plana: anclaje a cubierta de hormigón o contrapeso de hormigón
Tornillería de anclaje	No incluida
Inclinación	Estándar 15° o 30°
Disposición del módulo	Horizontal
Tamaño máximo del panel Kit	2279x1150 mm
Espesor del panel	28-40 mm
Perfilería	Aluminio EN AW-6005A T6 (Crudo o anodizado)
Tornillería	Acero inoxidable A2-70

KITS

25H2

COMPONENTES DEL KIT



TR25H

S10

S11

S08



Instalación en cubierta de chapa.
 Todos los puntos de anclaje del triángulo deben siempre anclarse a la correa de la cubierta.
 En caso contrario se deberá colocar una subestructura.
 Consultar apartado de subestructuras de este catálogo.



Formato Kit

[Ver manual de montaje](#)

Simple



29H



29.1H

Doble



26H



26.1H

Simple 29H

ESPECIFICACIONES

Superficie de instalación	Cubierta plana
Tamaño máximo del panel	2279x1150 mm 1800x1150 mm
Espesor del panel	28-40 mm
Inclinación	10° o 15°
Lastres	Lastres no incluidos. Sistema con portlastres regulables que permite colocar cualquier lastre del mercado (bordillos, bloques de hormigón...)
Perfilería	Aluminio EN AW-6005A T6 (Crudo o anodizado)
Tornillería	Acero inoxidable A2-70
Junta de estanqueidad	TPE-S de 30 mm

COMPONENTES DEL KIT

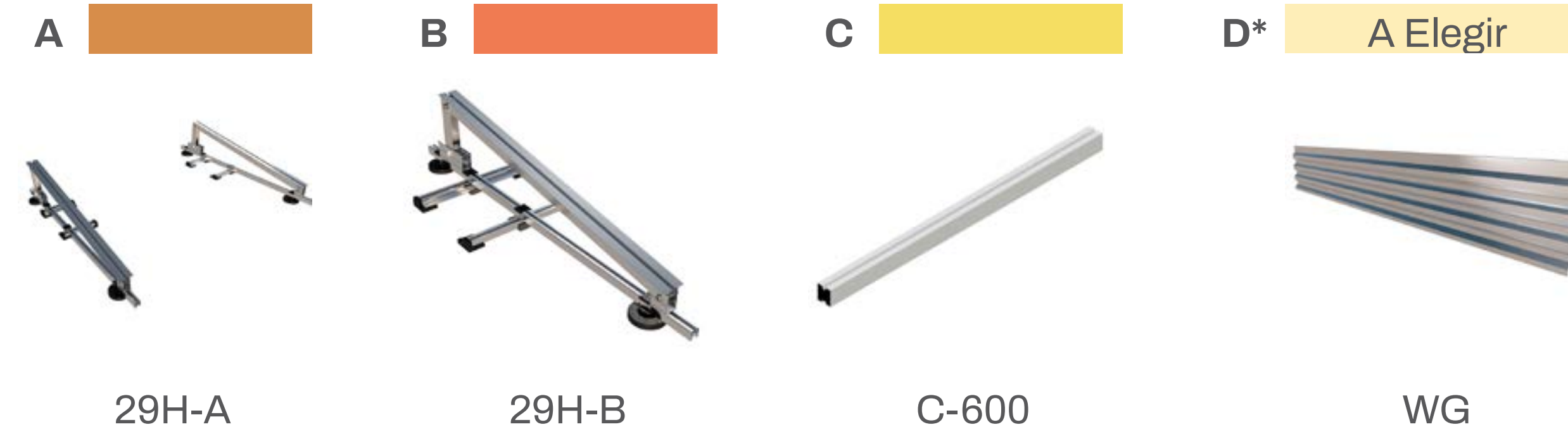

PIEZAS OPCIONALES



Componentes montados en la superficie de instalación.



***D a elegir**

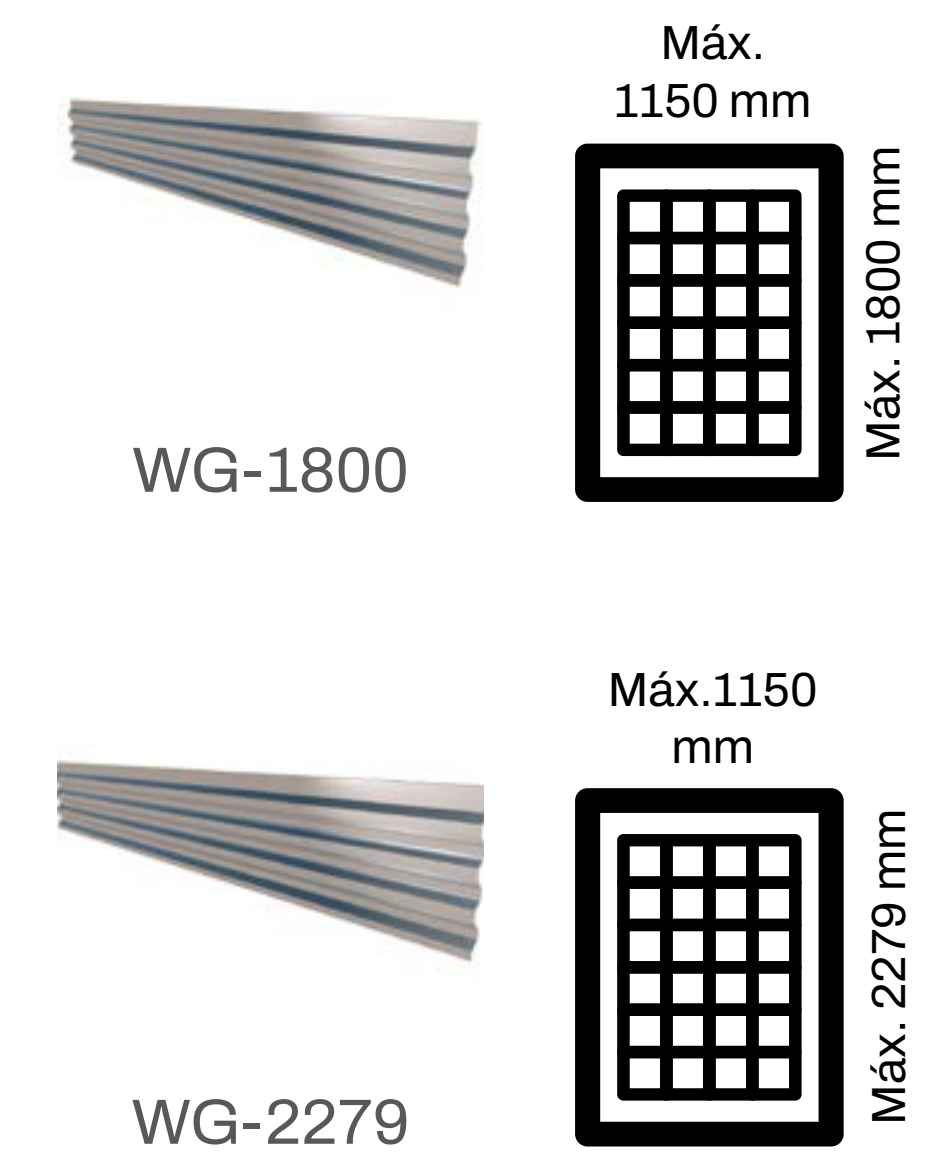

Formato Kit



Formato Bulk

[Ver Vídeo](#)

[Ver manual de montaje](#)

Simple

29.1H

ESPECIFICACIONES

Superficie de instalación	Cubierta plana
Tamaño máximo del panel	2400x1150 mm 2279x1150 mm 1800x1150 mm
Espesor del panel	28-40 mm
Inclinación	10° o 15°
Lastres	Lastres no incluidos. Sistema con portlastres regulables que permite colocar cualquier lastre del mercado (bordillos, bloques de hormigón...)
Perfilería	Aluminio EN AW-6005A T6 (Crudo o anodizado)
Tornillería	Acero inoxidable A2-70
Junta de estanqueidad	TPE-S de 30 mm

COMPONENTES DEL KIT

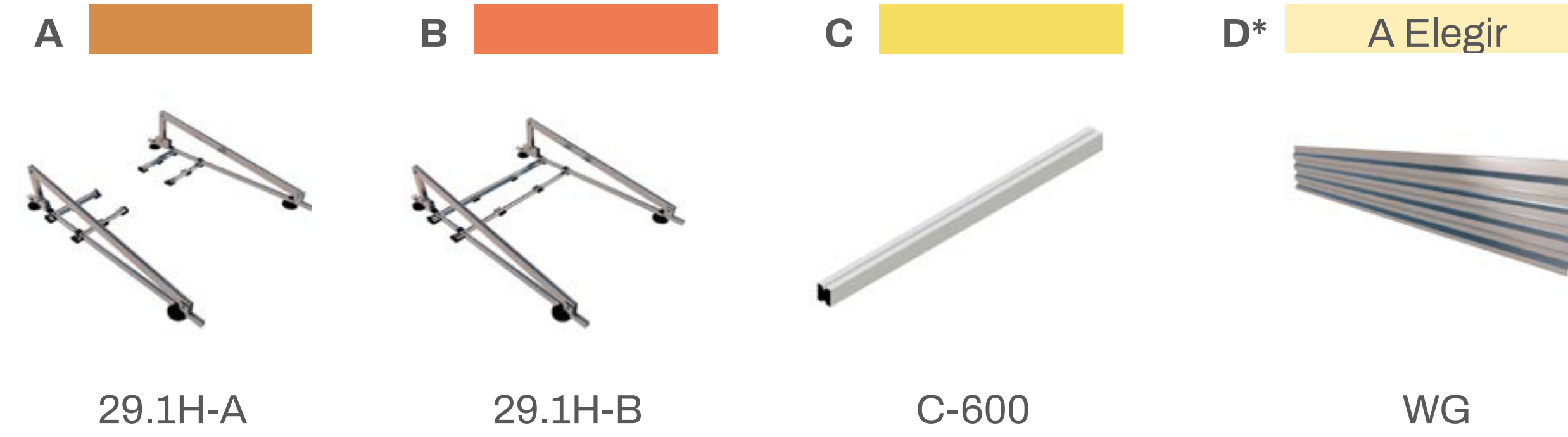

PIEZAS OPCIONALES



S13.4
No incluida

*D a elegir

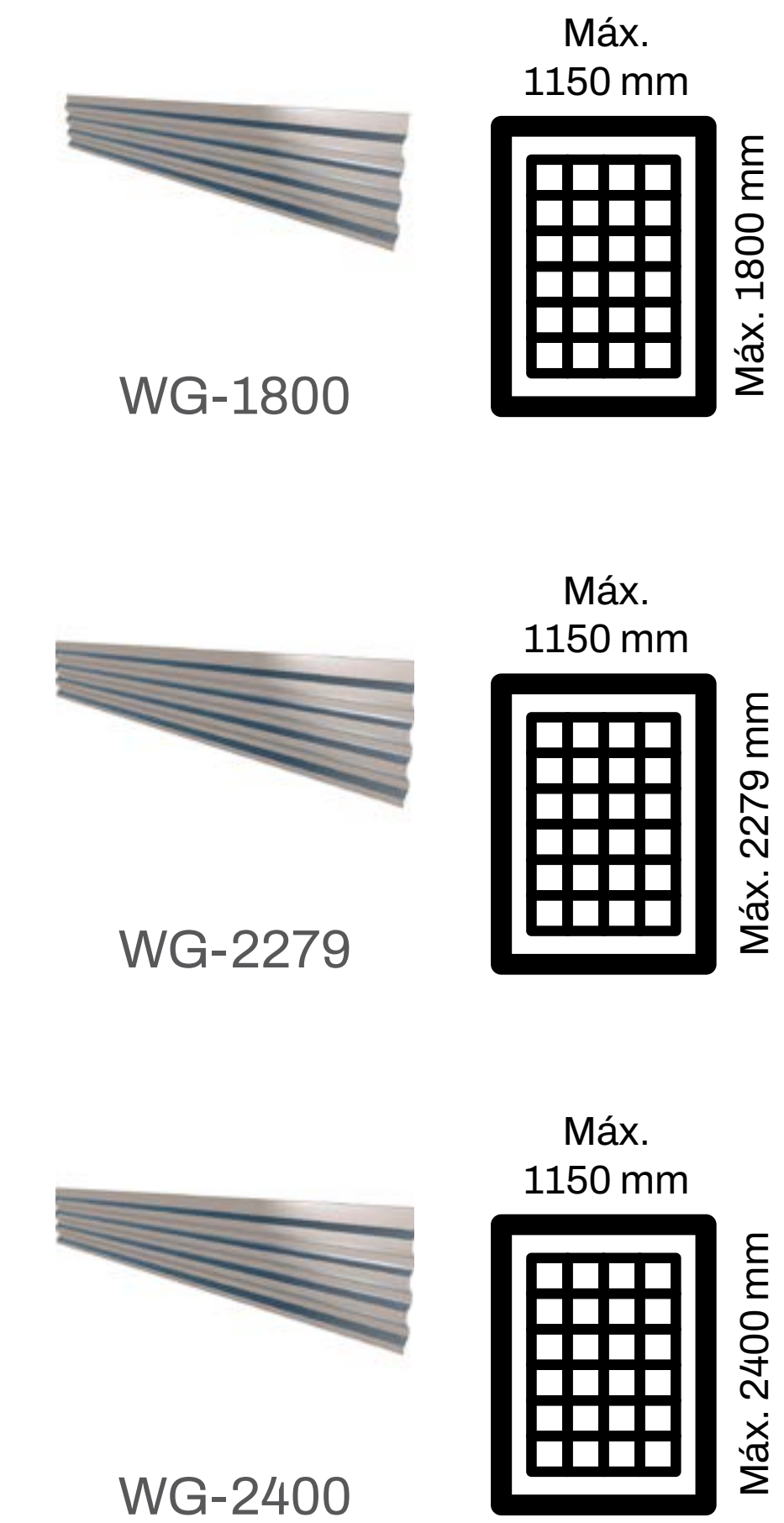

Componentes montados en la superficie de instalación.



Formato Kit



Formato Bulk

[Ver Vídeo](#)

[Ver manual de montaje](#)

Doble

26H

ESPECIFICACIONES

Superficie de instalación	Cubierta plana
Tamaño máximo del panel	2279x1150 mm
Espesor del panel	28-40 mm
Inclinación	10° o 15°
Lastres	Lastres no incluidos. Sistema con portlastres regulables que permite colocar cualquier lastre del mercado (bordillos, bloques de hormigón...)
Perfilería	Aluminio EN AW-6005A T6 (Crudo o anodizado)
Tornillería	Acero inoxidable A2-70
Junta de estanqueidad	TPE-S de 30 mm

COMPONENTES DEL KIT



PIEZAS OPCIONALES



Formato Kit



Formato Bulk

[Ver Vídeo](#)

[Ver manual de montaje](#)



Componentes montados en la superficie de instalación.



Doble

26.1H

ESPECIFICACIONES

Superficie de instalación	Cubierta plana
Tamaño máximo del panel	2400x1150 mm
Espesor del panel	28-40 mm
Inclinación	10° o 15°
Lastres	Lastres no incluidos. Sistema con portlastres regulables que permite colocar cualquier lastre del mercado (bordillos, bloques de hormigón...)
Perfilería	Aluminio EN AW-6005A T6 (Crudo o anodizado)
Tornillería	Acero inoxidable A2-70
Junta de estanqueidad	TPE-S de 30 mm

COMPONENTES DEL KIT

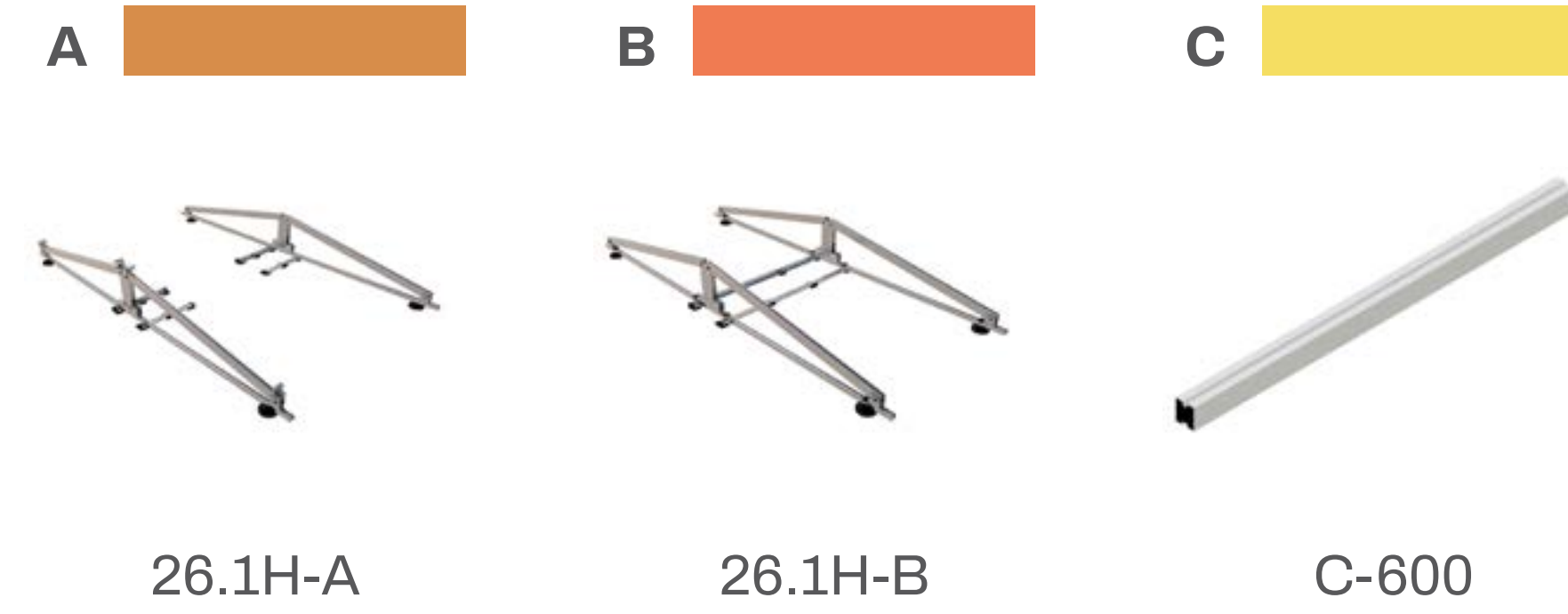

PIEZAS OPCIONALES



Formato Kit



Formato Bulk



Componentes montados en la superficie de instalación.



[Ver Vídeo](#)

[Ver manual de montaje](#)

Paredes

Balcón

15V

15H

16H

PRÓXIMAMENTE

66H



ESPECIFICACIONES

Superficie de instalación	Fachada
Superficie de anclaje	Hormigón
Tornillería de anclaje	No incluida
Inclinación	Estándar 30° y 35° (depende posición montaje)
Disposición del módulo	Vertical
Tamaño máximo del panel Kit	2279x1150 mm
Tamaño máximo del panel Bulk	2279x1350 mm
Espesor del panel	28-40 mm
Perfilería	Aluminio EN AW-6005A T6 (Crudo o anodizado)
Tornillería	Acero inoxidable A2-70

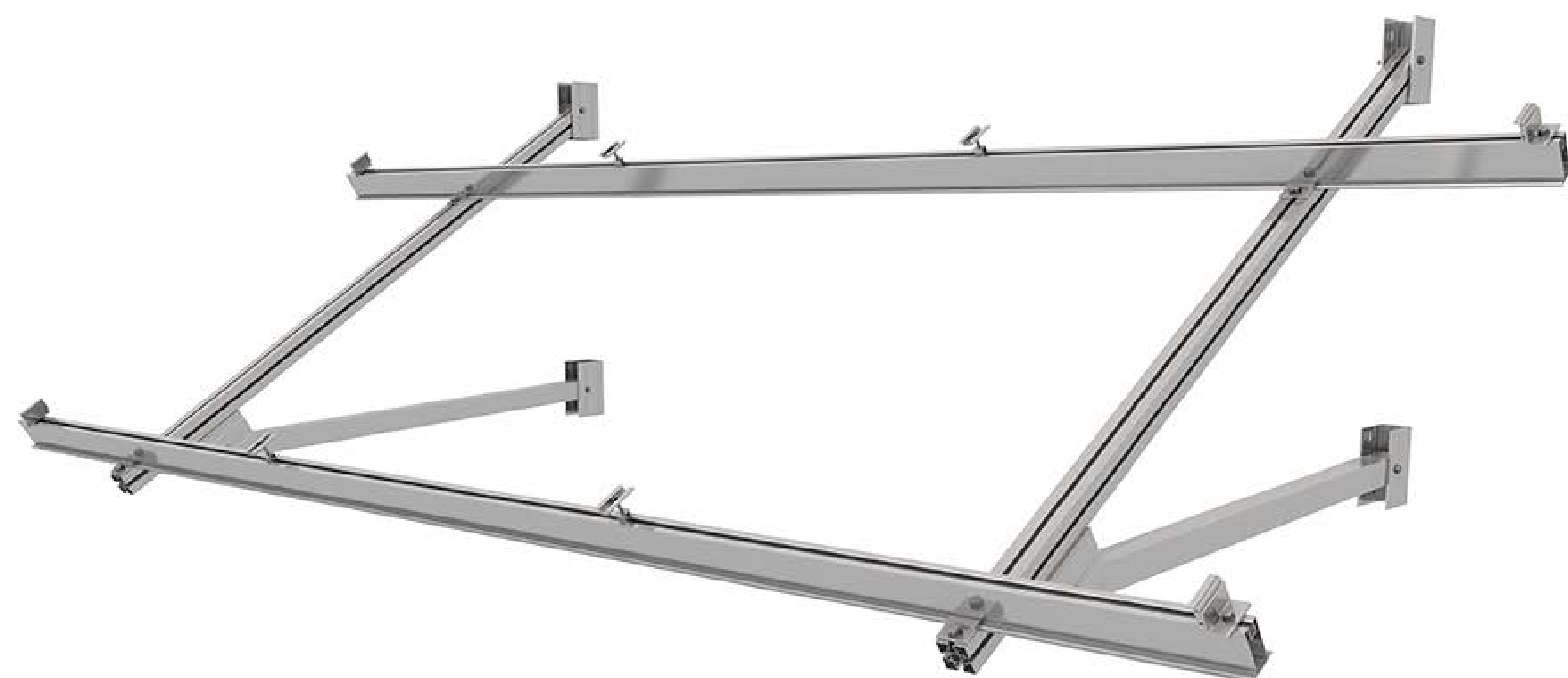

KITS

15V1

15V2

15V3

SIST. UNIÓN

S17

COMPONENTES DEL KIT



TR15V



G2

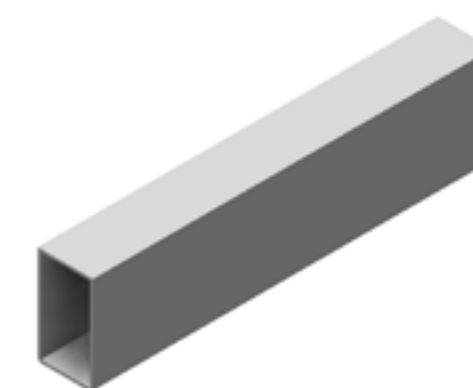

UG2/UG4

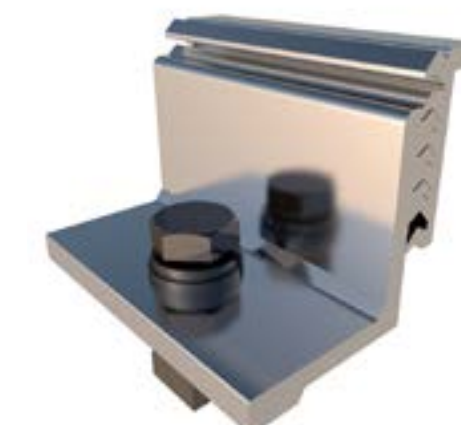

S10



S11



Formato Kit



Formato Bulk

[Ver Vídeo](#)

[Ver manual de montaje](#)

ESPECIFICACIONES

Superficie de instalación	Fachada
Superficie de anclaje	Hormigón
Tornillería de anclaje	No incluida
Inclinación	Estándar 30° y 35° (depende posición montaje)
Disposición del módulo	Horizontal
Tamaño máximo del panel Kit	2279x1150 mm
Espesor del panel	28-40 mm
Perfilería	Aluminio EN AW-6005A T6 (Crudo o anodizado)
Tornillería	Acero inoxidable A2-70

KITS

15H1

COMPONENTES DEL KIT



TR15H

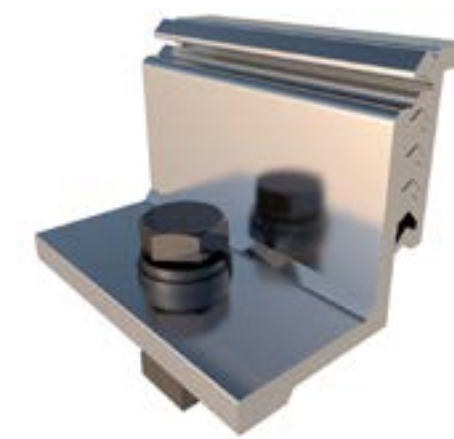

S10



Formato Kit

[Ver Vídeo](#)

[Ver plano de montaje](#)



ESPECIFICACIONES

Superficie de instalación	Fachada
Superficie de anclaje	Hormigón
Tornillería de anclaje	No incluida
Inclinación	Estándar 30° y 35° (depende posición montaje)
Disposición del módulo	Horizontal
Tamaño máximo del panel Kit	2279x1150 mm
Espesor del panel	28-40 mm
Perfilería	Aluminio EN AW-6005A T6 (Crudo o anodizado)
Tornillería	Acero inoxidable A2-70

KITS

16H2

COMPONENTES DEL KIT



TR16H

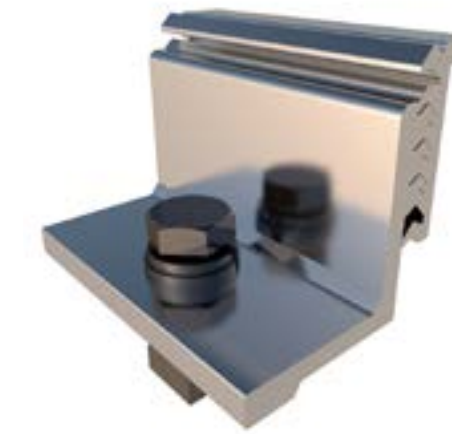

S10



S11



Formato Kit

[Ver Vídeo](#)

[Ver plano de montaje](#)



1 Fila

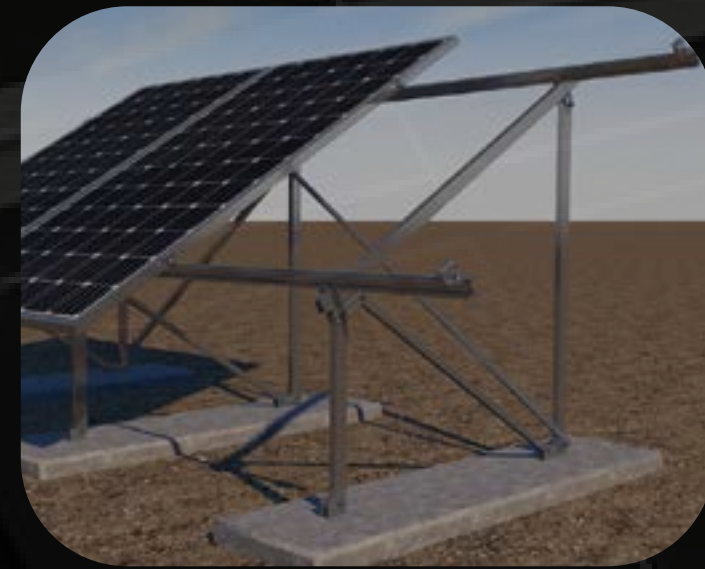

40V

Poste

17H

18H

2 Filas

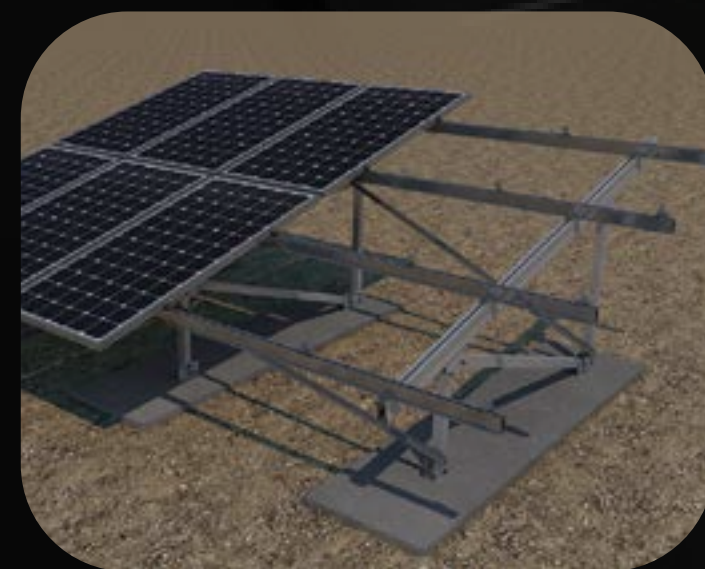

31V

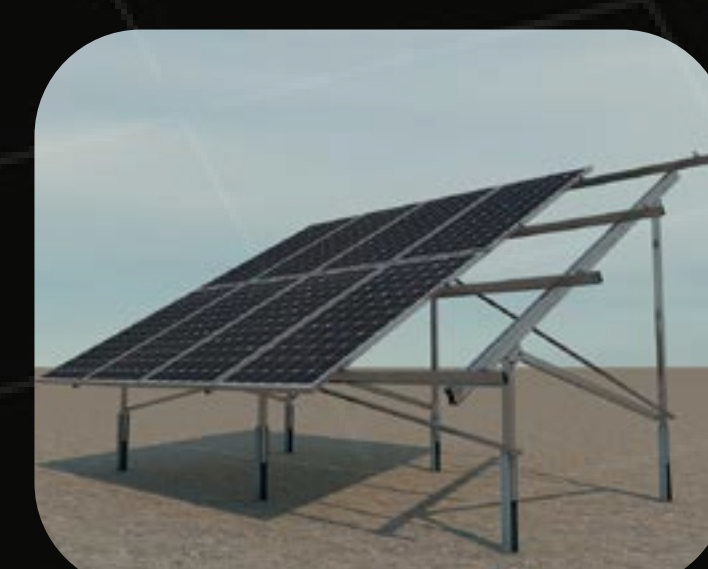

35V

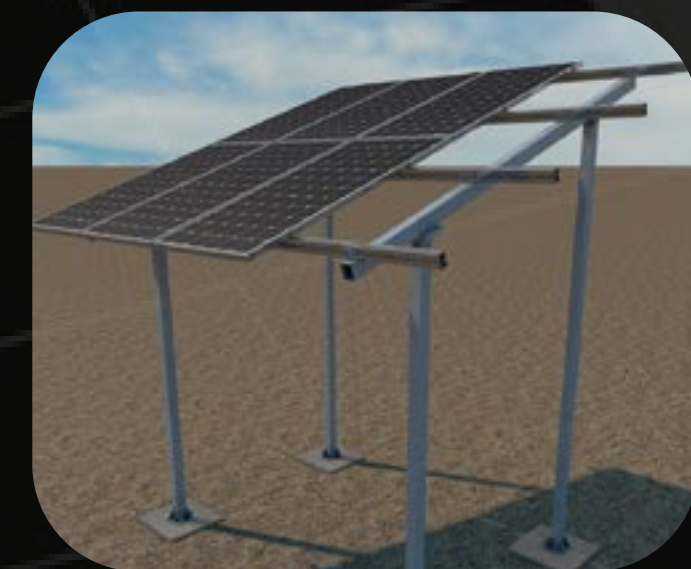

38V

3 Filas



33V



37V

1 Fila

40V

ESPECIFICACIONES

Superficie de instalación	Terreno
Superficie de anclaje	Cimentación de hormigón
Tamaño máximo del panel Kit	2279x1150 mm
Tamaño máximo del panel Bulk	2279x1150 mm
Espesor del panel	28-40 mm
Inclinación	30°
Tornillería de anclaje	No incluida
Perfilería	Aluminio EN AW-6005A T6 (Crudo o anodizado)
Tornillería	Acero inoxidable A2-70

KITS

40V1

40V2

40V3

40V4

SIST. UNIÓN

S15

COMPONENTES DEL KIT



TR40V



G1



TG1

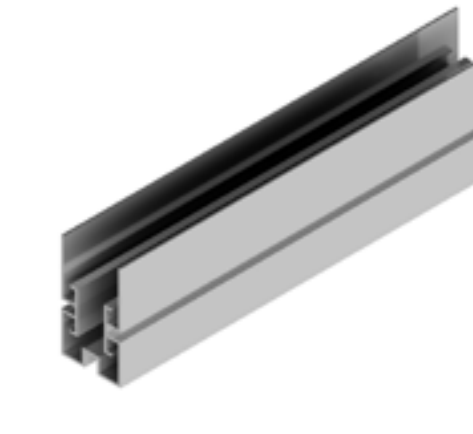

UG1

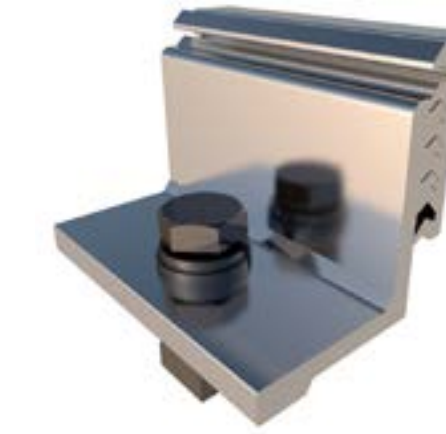

S10



S11

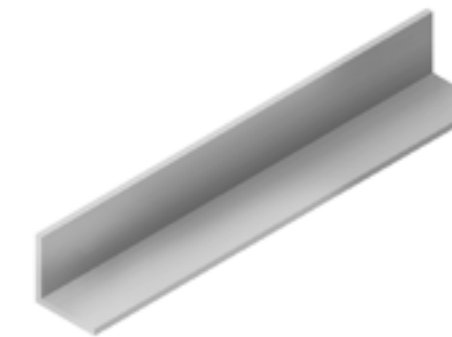

S08

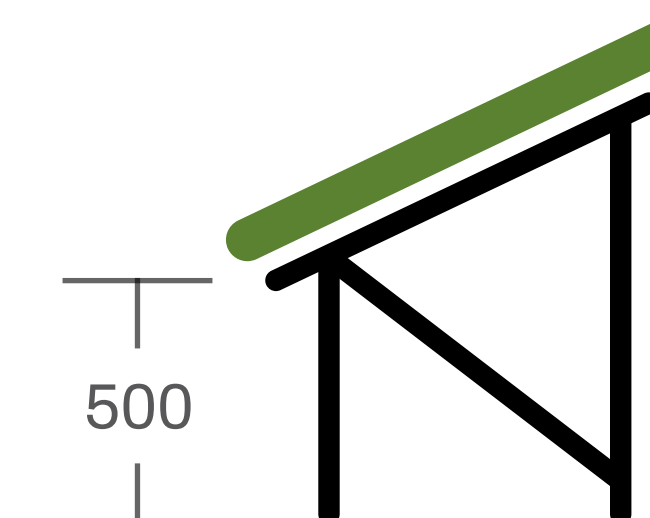
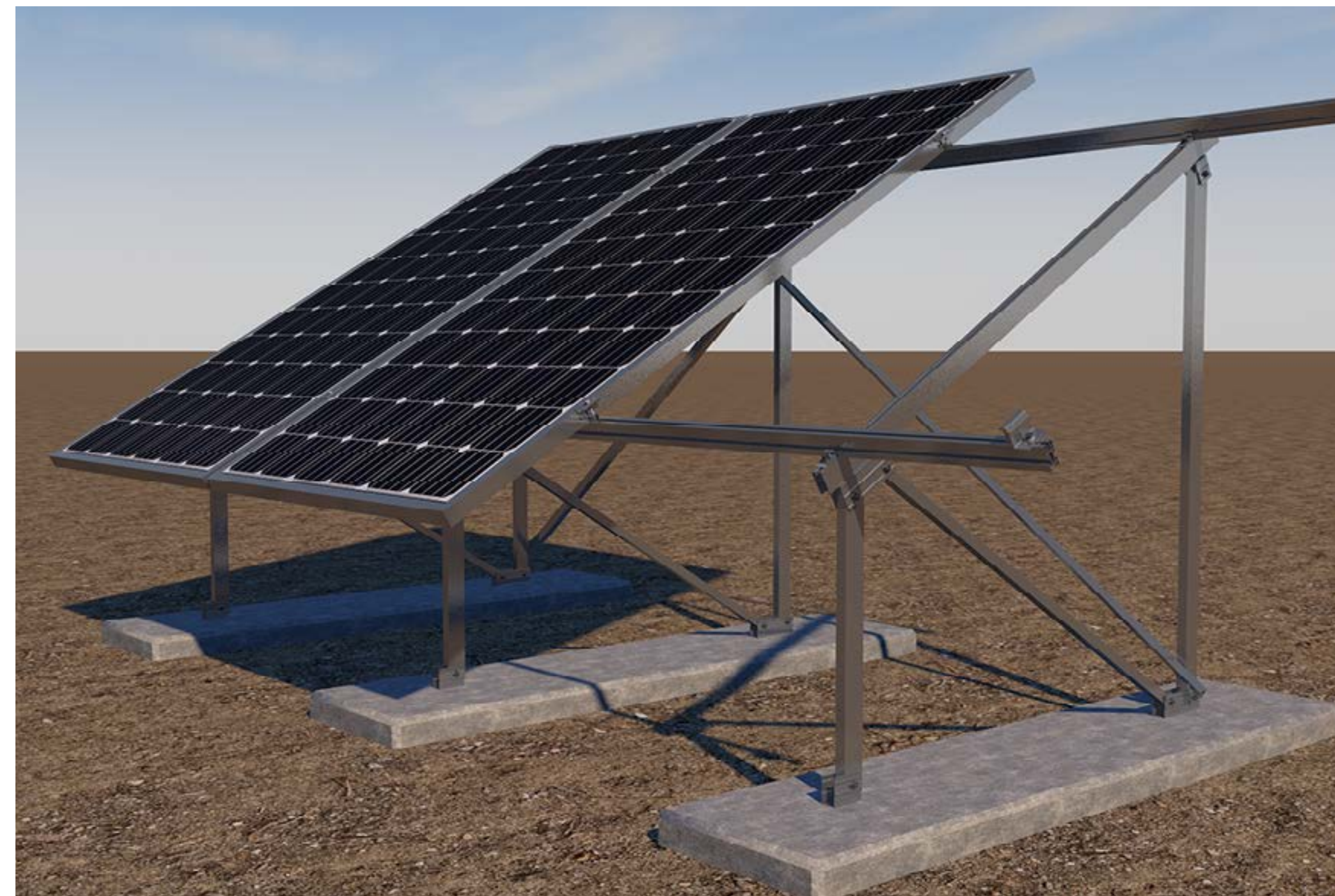

Formato Kit



Formato Bulk

[Ver Vídeo](#)

[Ver manual de montaje](#)

2 Filas

31V

ESPECIFICACIONES

Superficie de instalación	Terreno
Superficie de anclaje	Cimentación de hormigón
Tamaño máximo del panel Kit	2279x1150 mm
Tamaño máximo del panel Bulk	2279x1150 mm
Espesor del panel	28-40 mm
Inclinación	30°
Tornillería de anclaje	No incluida
Perfilería	Aluminio EN AW-6005A T6 (Crudo o anodizado)
Tornillería	Acero inoxidable A2-70



KITS

31V4

31V6

31V8

31V10

31V12

SIST. UNIÓN

S17.2

COMPONENTES DEL KIT



TR31V



G2

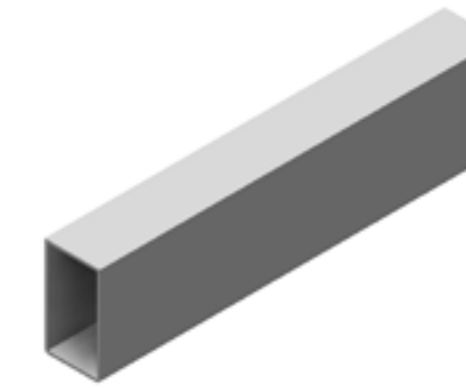

UG2/UG4

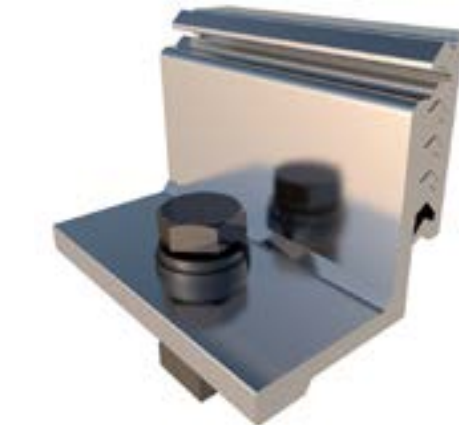

S10



S11

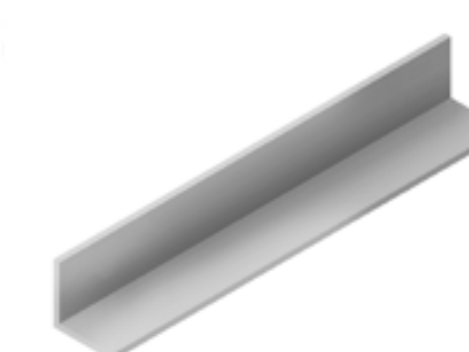

S09

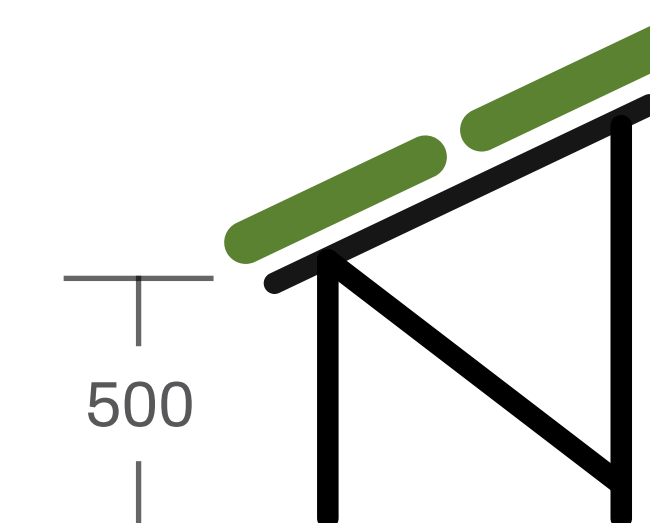
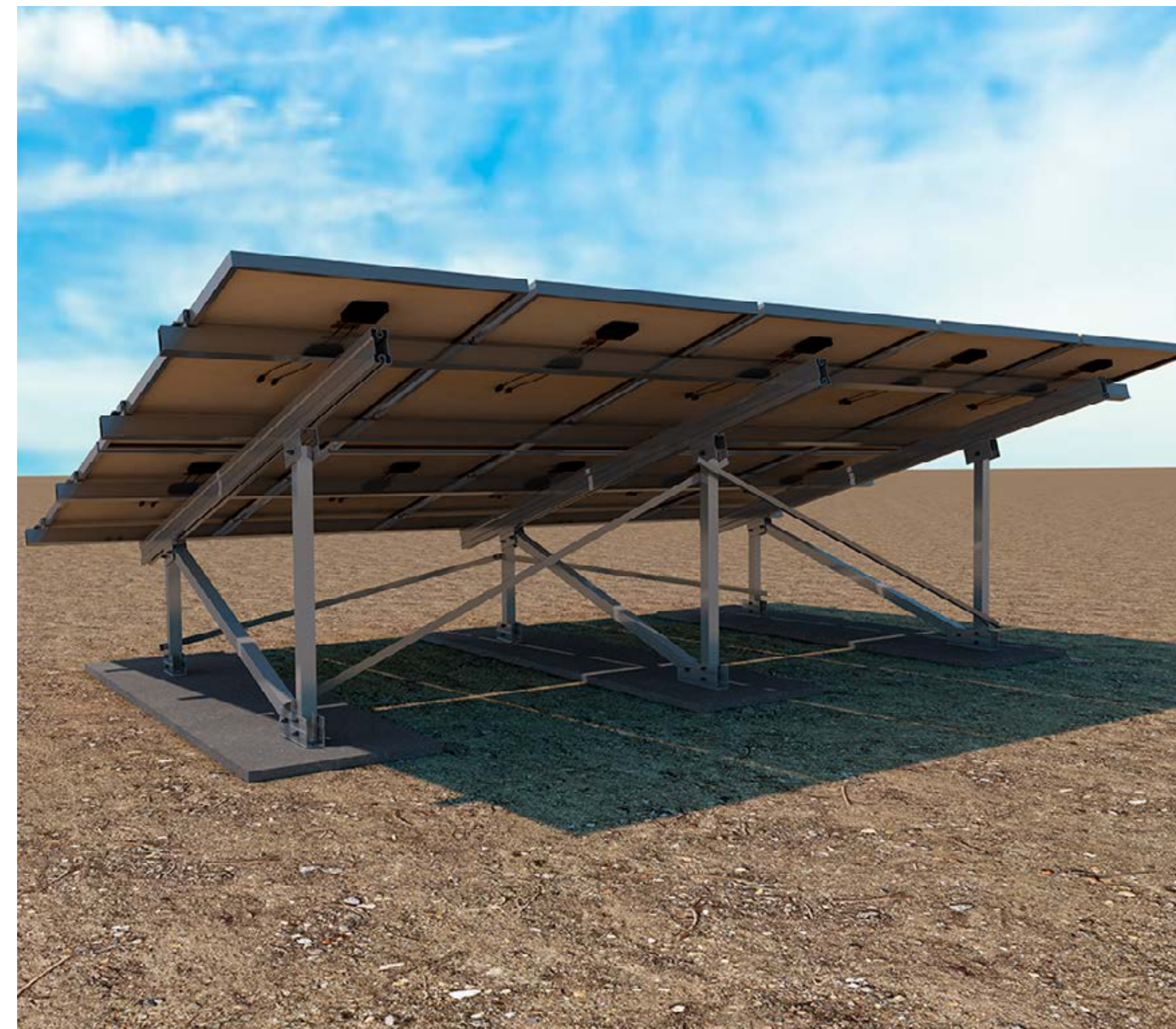

Formato Kit



Formato Bulk

[Ver Vídeo](#)

[Ver manual de montaje](#)

2 Filas

35V

ESPECIFICACIONES

Superficie de instalación	Terreno
Superficie de anclaje	Terreno con hincas
Tamaño máximo del panel Kit	2279x1150 mm
Tamaño máximo del panel Bulk	2279x1150 mm
Espesor del panel	28-40 mm
Inclinación	30°
Estructura de soporte	Hincas incluidas (Acero galvanizado en caliente)
Perfilería	Aluminio EN AW-6005A T6 (Crudo o anodizado)
Tornillería	Acero inoxidable A2-70

KITS

35V4

35V6

35V8

35V10

35V12

SIST. UNIÓN

S17.2

COMPONENTES DEL KIT



TR35V



G2

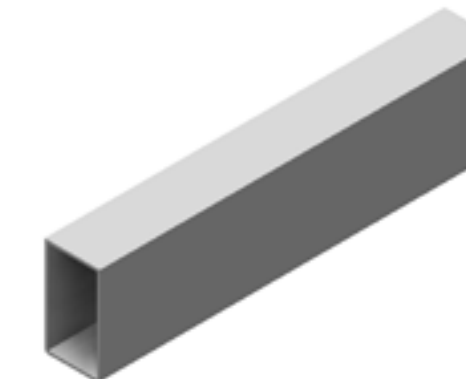

UG2/UG4

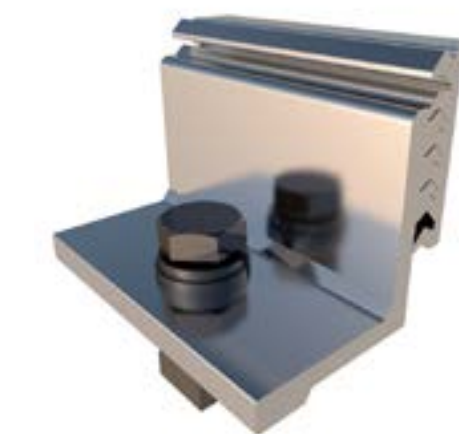

S10



S11

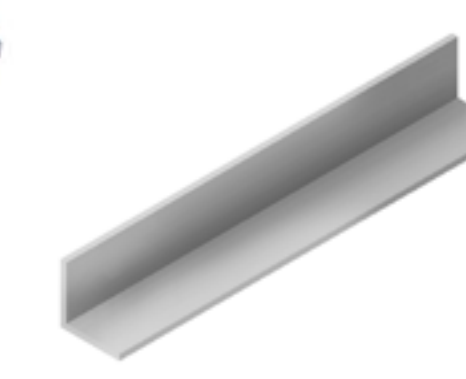

S09

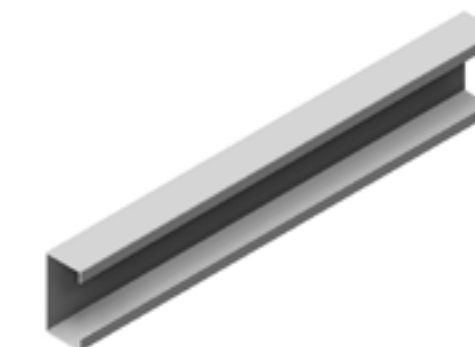

Hinca
(solo incluida
en formato Kit)



Formato Kit



Formato Bulk

[Ver Vídeo](#)

[Ver manual de montaje](#)

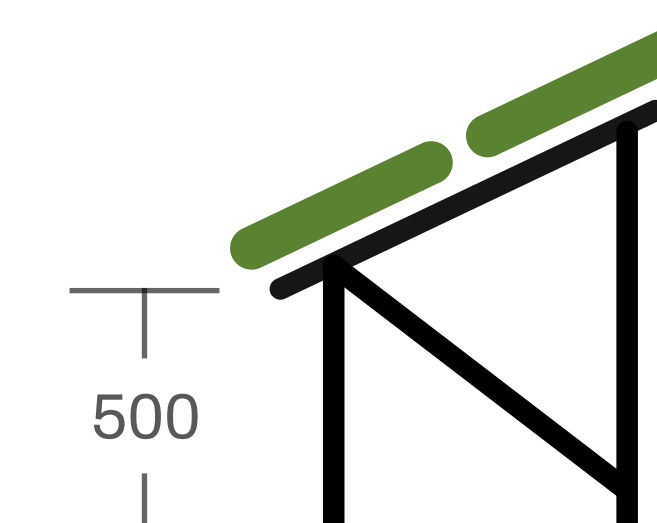
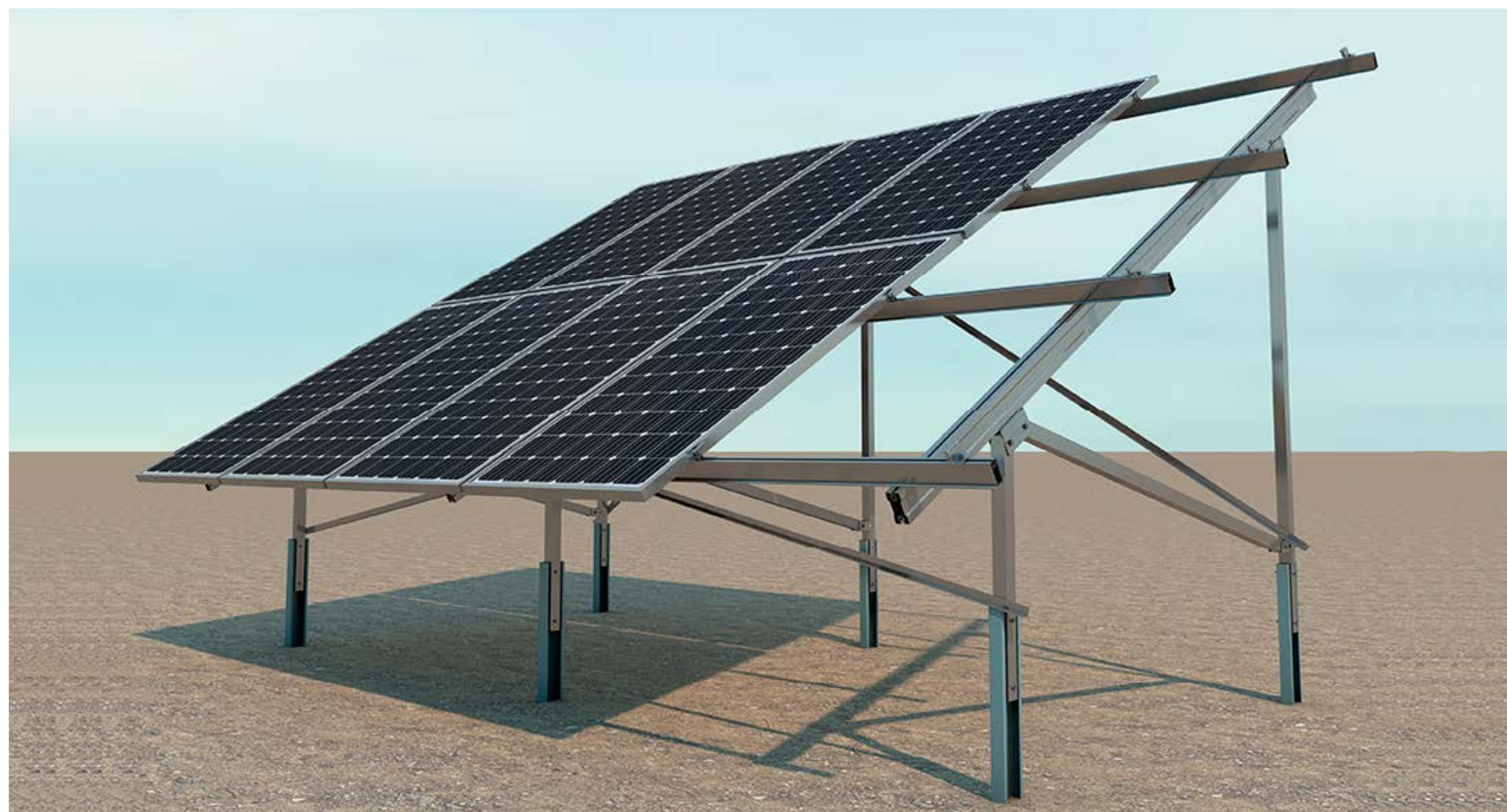

2 Filas

38V

ESPECIFICACIONES

Superficie de instalación	Terreno
Superficie de anclaje	Cimentación de hormigón
Tamaño máximo del panel Kit	2279x1150 mm
Espesor del panel	28-40 mm
Inclinación	20°
Altura	2799 mm
Tornillería de anclaje	No incluida
Perfilería	Aluminio EN AW-6005A T6 (Crudo o anodizado)
Tornillería	Acero inoxidable A2-70
Pilares	Acero galvanizado en caliente

KITS

38V8-20

38V-A1

38V-A2

38V-A3

38V-A4

 Especial para Agrovoltaica

COMPONENTES DEL KIT



TR38V



G7

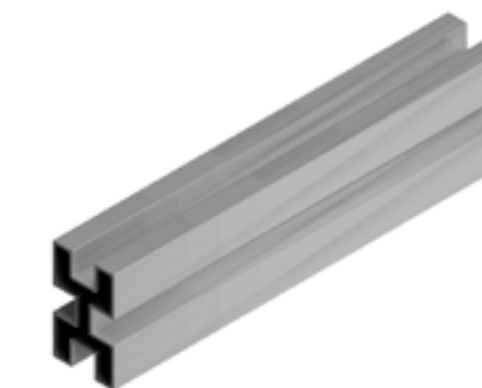

UG7

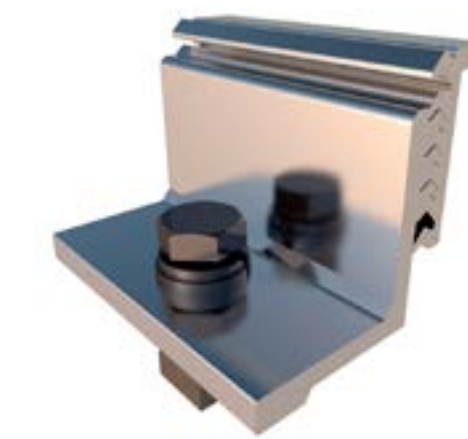

S10



S11



Formato Kit

[Ver manual de montaje](#)

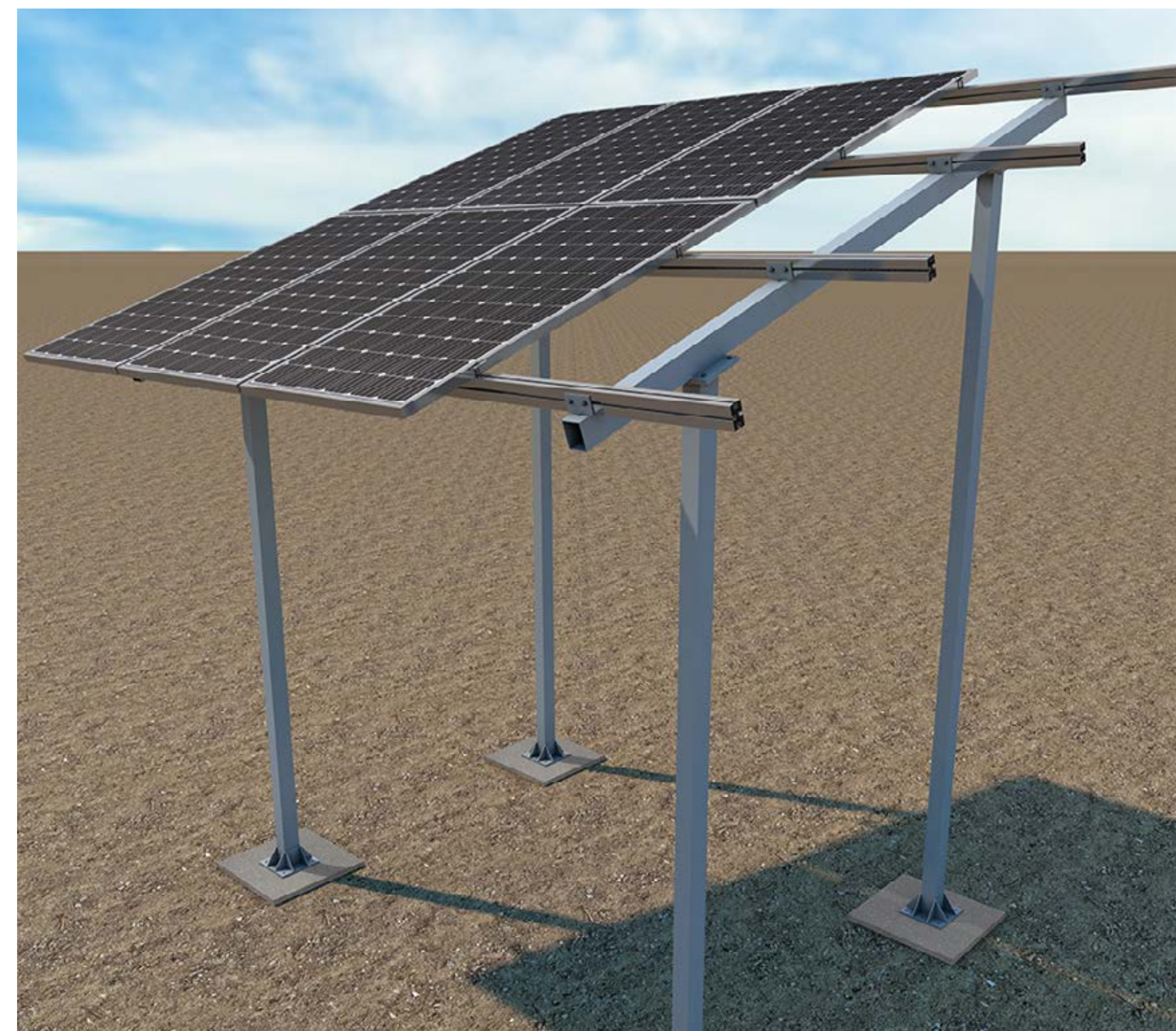

3 Filas

33V

ESPECIFICACIONES

Superficie de instalación	Terreno
Superficie de anclaje	Cimentación de hormigón
Tamaño máximo del panel Kit	2279x1150 mm
Tamaño máximo del panel Bulk	2279x1150 mm
Espesor del panel	28-40 mm
Inclinación	30°
Tornillería de anclaje	No incluida
Perfilería	Aluminio EN AW-6005A T6 (Crudo o anodizado)
Tornillería	Acero inoxidable A2-70



KITS	33V6	33V9	33V12	33V15	33V18	SIST. UNIÓN	S17.3
------	------	------	-------	-------	-------	-------------	-------

COMPONENTES DEL KIT

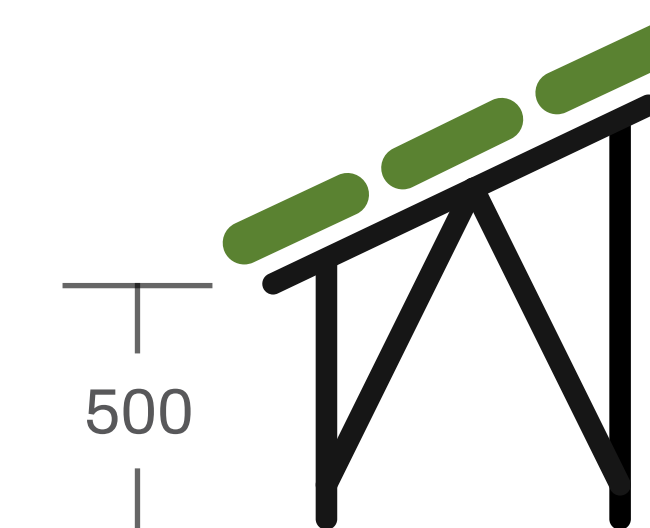
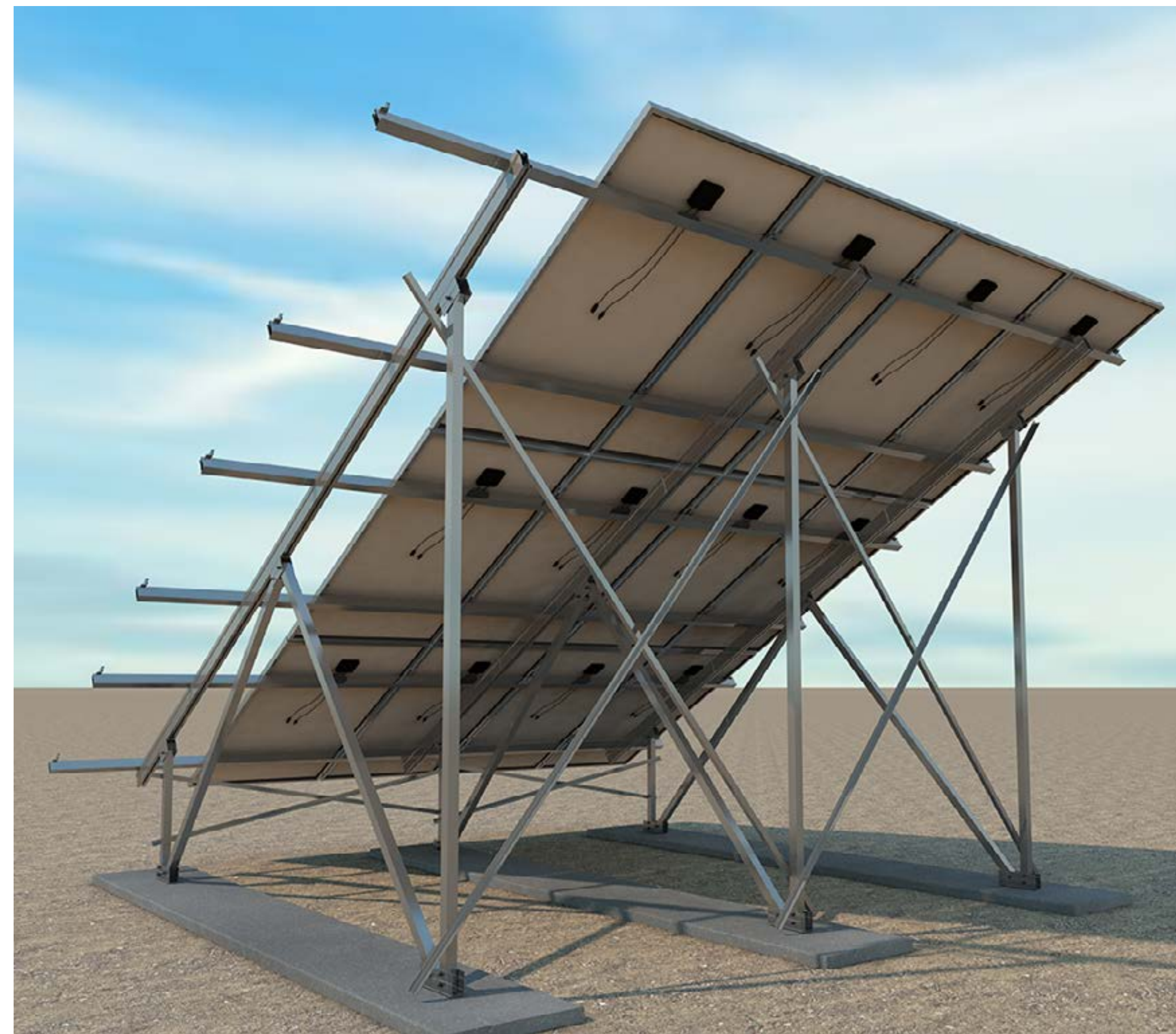
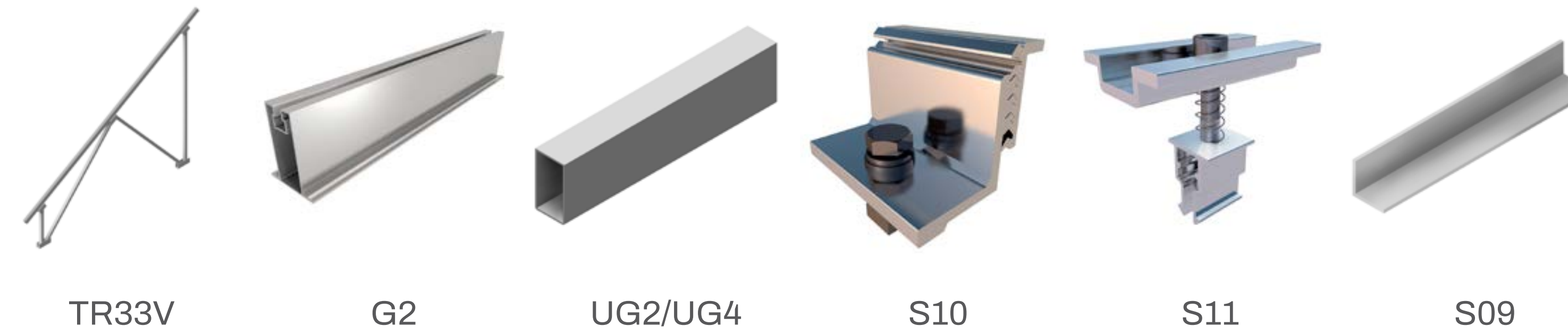

Formato Kit



Formato Bulk

[Ver manual de montaje](#)

3 Filas

37V

ESPECIFICACIONES

Superficie de instalación	Terreno
Superficie de anclaje	Cimentación de hormigón
Tamaño máximo del panel Kit	2279x1150 mm
Tamaño máximo del panel Bulk	2279x1150 mm
Espesor del panel	28-40 mm
Inclinación	30°
Estructura de soporte	Hincas incluidas (Acero galvanizado en caliente)
Perfilería	Aluminio EN AW-6005A T6 (Crudo o anodizado)
Tornillería	Acero inoxidable A2-70

KITS

37V6

37V9

37V12

37V15

37V18

SIST. UNIÓN

S17.3

COMPONENTES DEL KIT



TR37V



G2

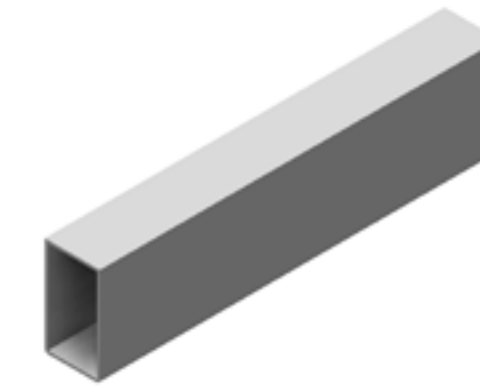

UG2/UG4

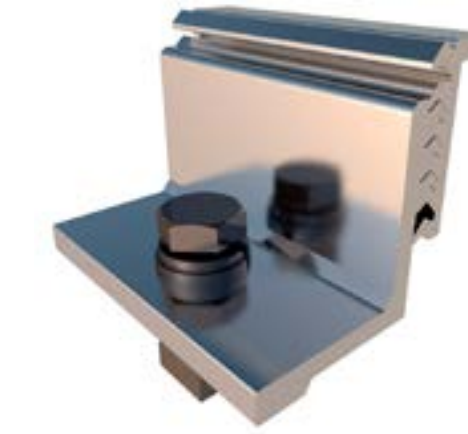

S10



S11

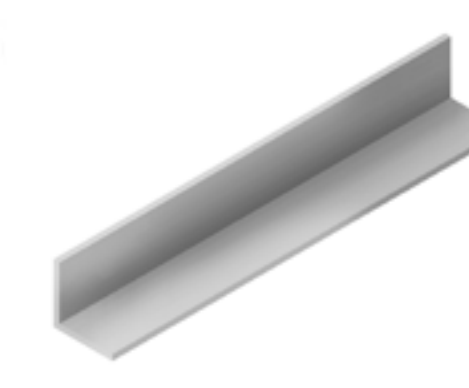

S09

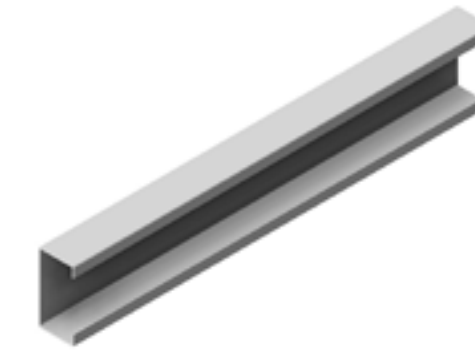

Hinca
(solo incluida
en formato Kit)



Formato Kit



Formato Bulk

[Ver manual de montaje](#)

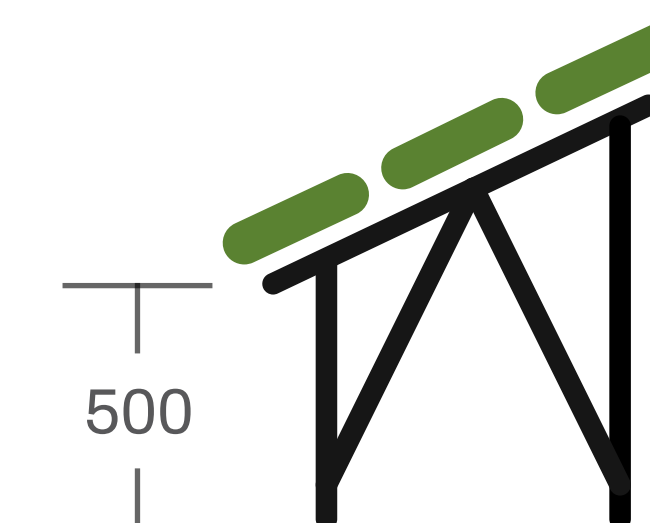
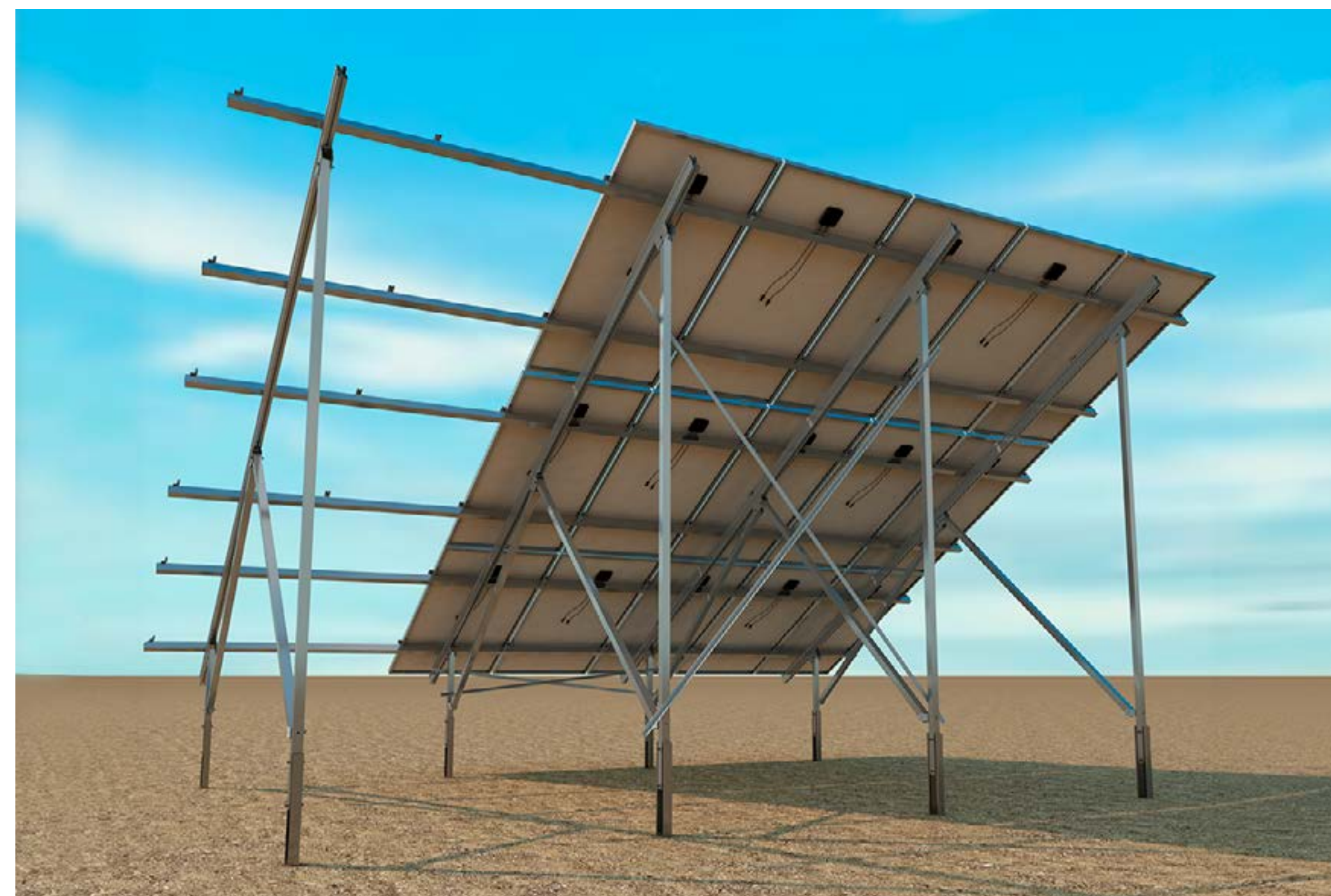

ESPECIFICACIONES

Superficie de instalación	Poste existente (Ø mín. 90 mm / máx. 140 mm) Redondo o cuadrado
Tornillería de anclaje	Abarcón (Según Ø)
Inclinación	Estándar 30°
Disposición del módulo	Horizontal
Tamaño máximo del panel Kit	2279x1150 mm
Espesor del panel	28-40 mm
Perfilería	Aluminio EN AW-6005A T6 (Crudo o anodizado)
Tornillería	General: Acero inoxidable A2-70 Fijación: Acero galvanizado



KITS

17H1

17H2

COMPONENTES DEL KIT



Estructura soporte

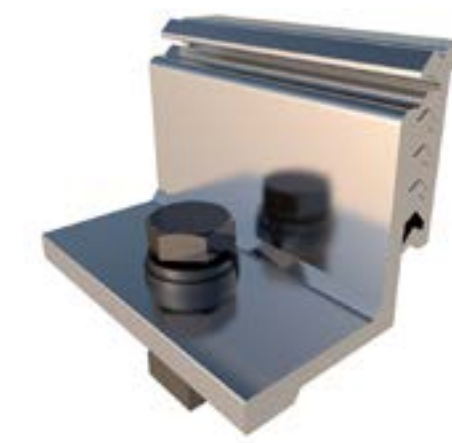

S10



S11



Abarcón



Formato Kit

[Ver Vídeo](#)

[Ver ficha técnica](#)

Poste

18H

ESPECIFICACIONES

Superficie de instalación	Poste de 3 m
Superficie de anclaje	Cimentación de hormigón
Tornillería de anclaje	No incluida
Inclinación	Regulable de 0° a 15°
Disposición del módulo	Horizontal
Tamaño máximo del panel Kit	2279x1150 mm
Espesor del panel	28-40 mm
Perfilería	Aluminio EN AW-6005A T6 (Crudo o anodizado)
Tornillería	Acero inoxidable A2-70

KITS

18H1

18H2

 Especial para Agrovoltaica

COMPONENTES DEL KIT



Estructura soporte

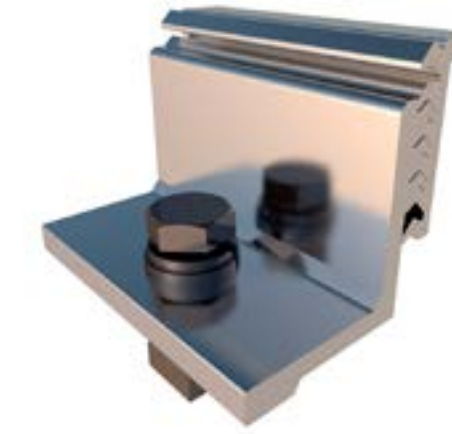

S10



S11



Formato Kit

[Ver ficha técnica](#)



Monoposte de acero galvanizado.



Simple



PR1



PR2

Nuevo diseño

Doble



PR3

Grandpark



GP

Nuevo Concepto

Marquesinas Industriales

Información de las marquesinas de aparcamiento:



PR1

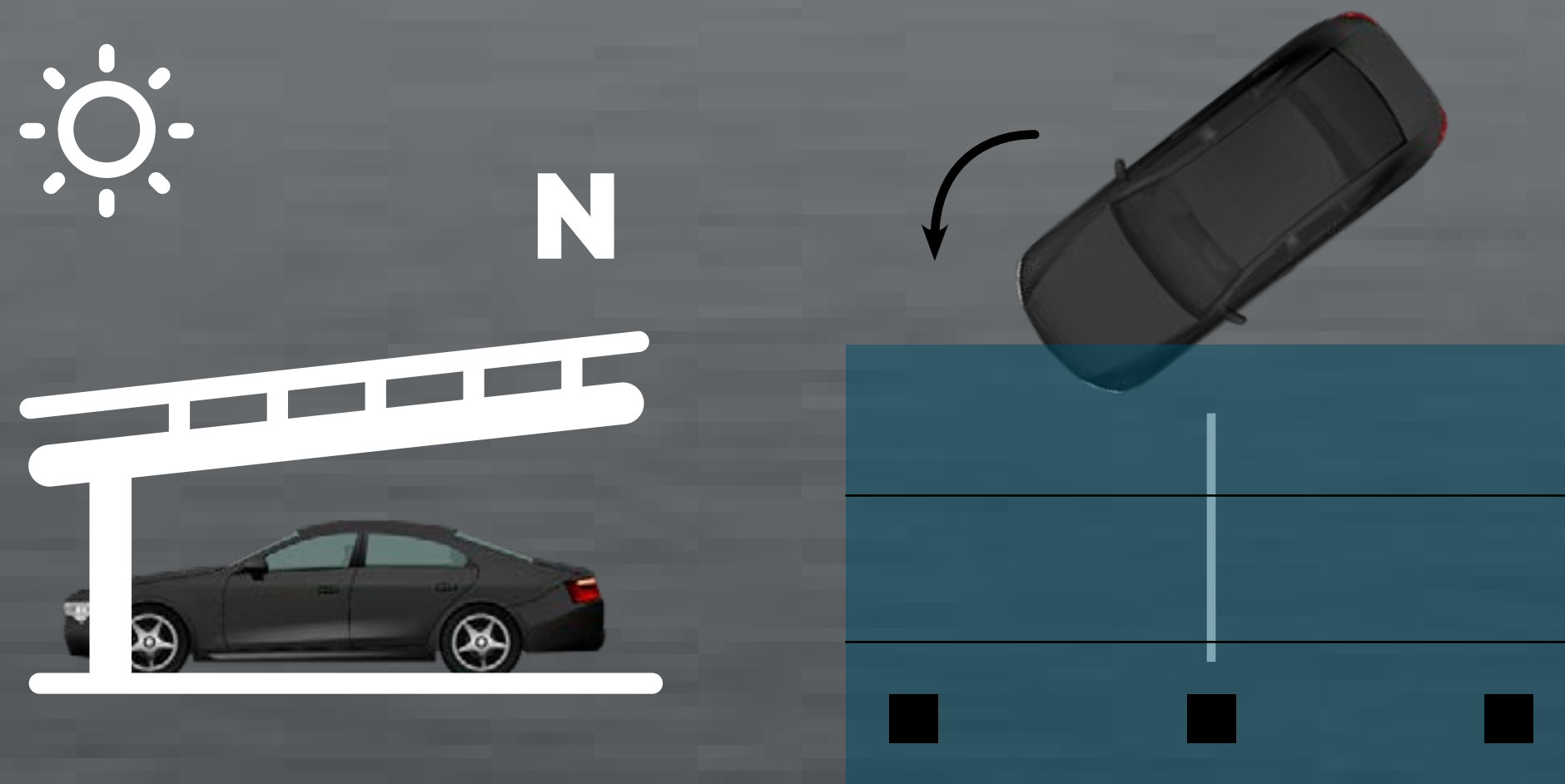

PR2

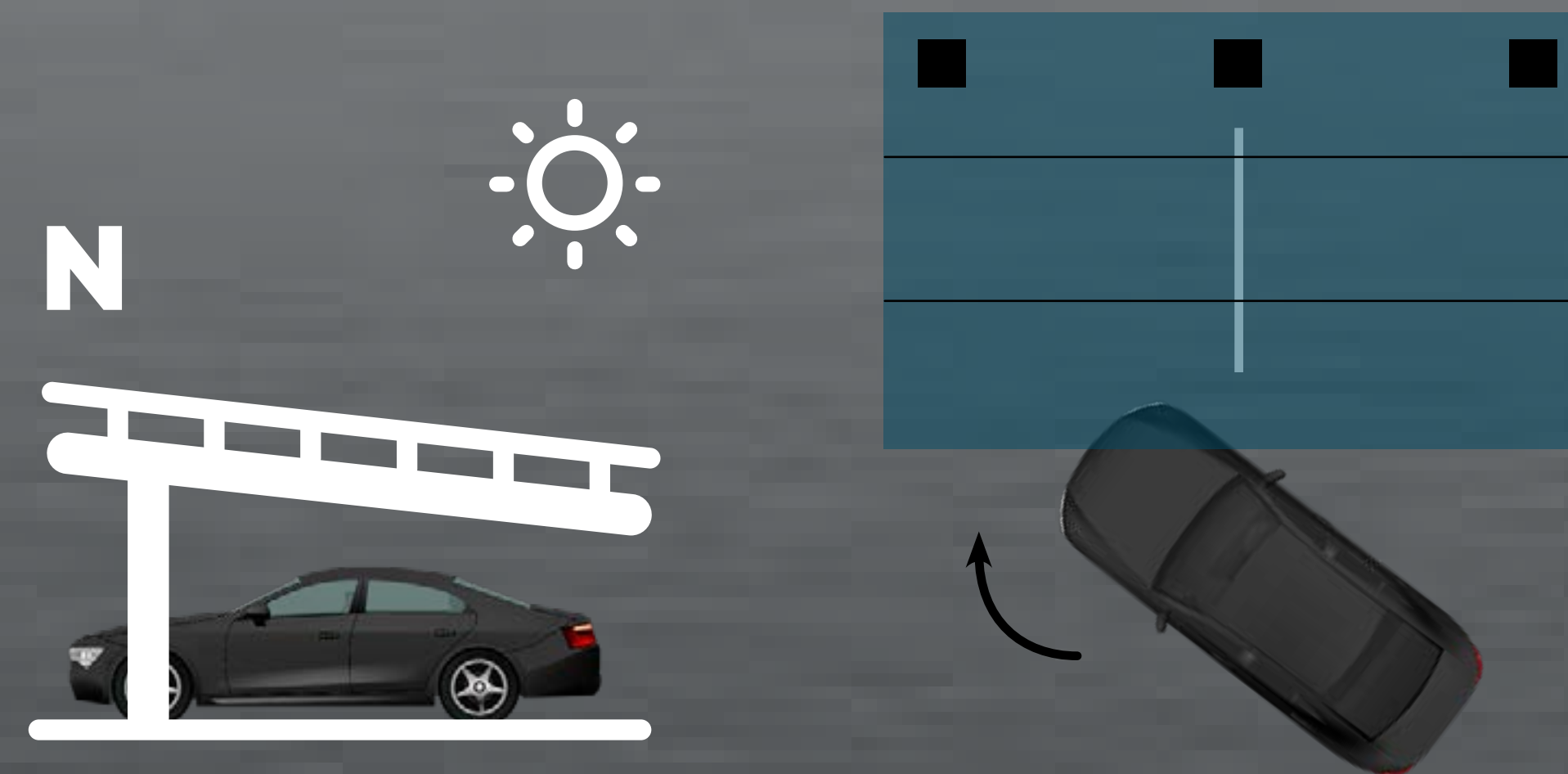

PR3

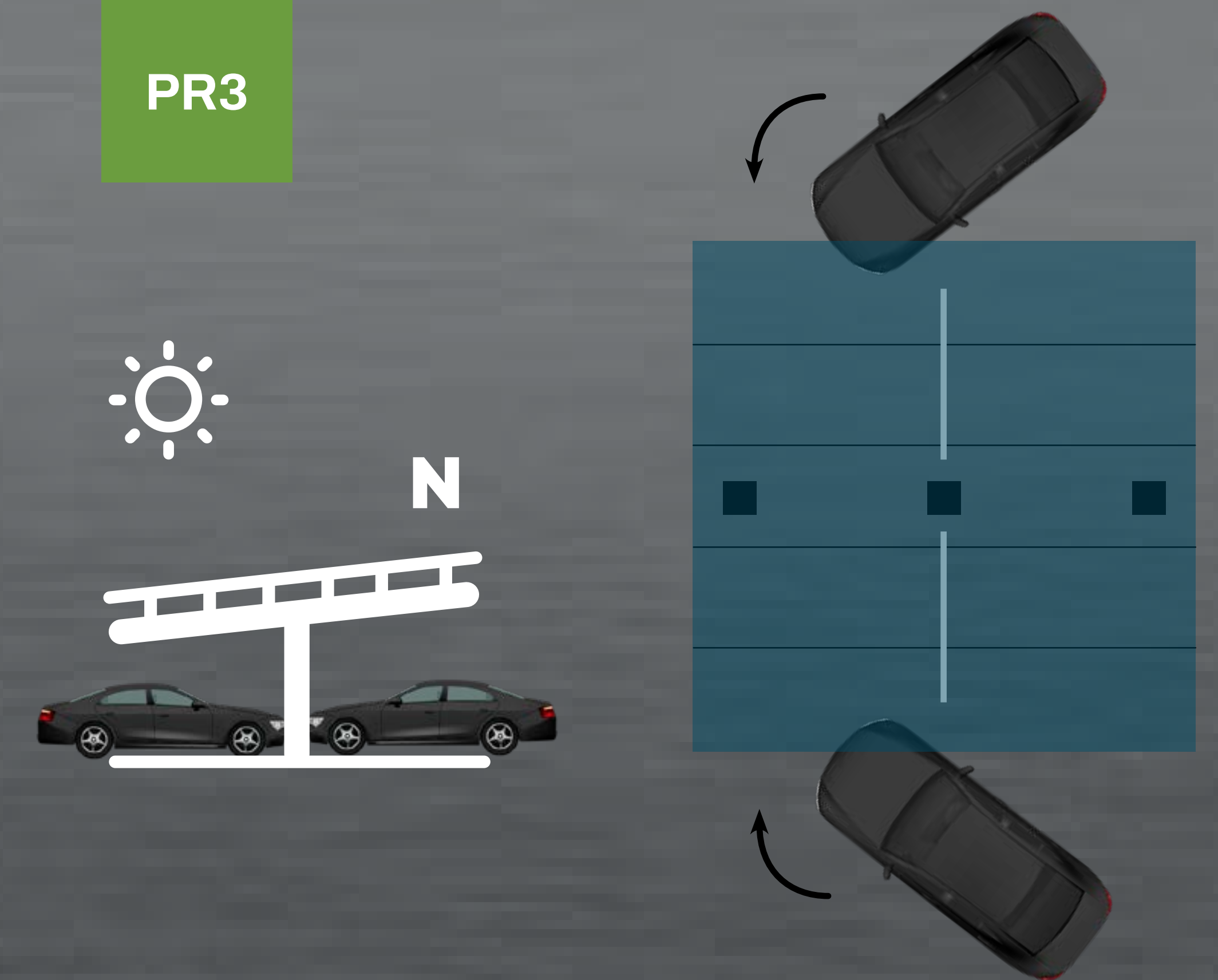

❌ **Concepto Anterior**

PR1 - Parking **SUR** 5°.
(La posición del pilar está al Sur).

❌ **Concepto Anterior**

PR2 - Parking **NORTE** 5°.
(La posición del pilar estaba al Norte).

❌ **Concepto Anterior**

PR3 - Parking **DOBLE** 5°.

✅ **NUEVO Concepto**

PR1 - Parking acceso **NORTE** 5°.
(La posición del pilar está al Sur).

✅ **NUEVO Concepto**

PR2 - Parking acceso **SUR** 5°.
(La posición del pilar está al Norte).

✅ **NUEVO Concepto**

PR3 - Parking **DOBLE** acceso a un agua 5°.

Nuevo Diseño

Marquesinas Industriales

La innovación estructural para parkings

✓ **Fusión 2 en 1**
(Anteriores PR + PR.1)

✓ **+ Resistencia mismo coste**
Alcanzan mayores cargas sin incrementar costes

✓ **+ Rigidez**
Consiguen mayor rigidez en la unión viga-pilar.

✓ **Disponibles en 3 modelos:**

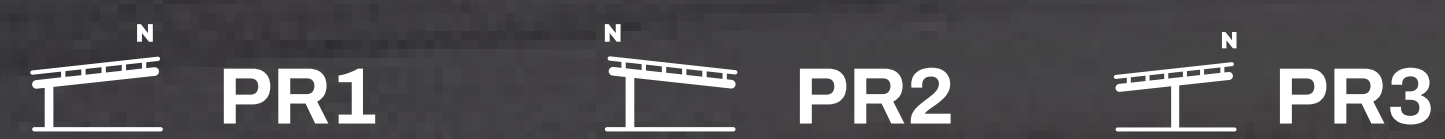

Distintos acabados:

- ✓ Galvanizado
- Galvanizado y lacado negro
- Galvanizado y lacado gris antracita
- Galvanizado y lacado blanco

¡Contáctanos y únete a la revolución del parking con Sunfer!

sunferenergy.com

Sujeto a cambios sin previo aviso. Las ilustraciones de los productos son orientativas y pueden diferir del producto suministrado.

ANTES	
Viento (Km/h)	Nieve (Kg/m ²)
110	40
130	20

AHORA	
Viento (Km/h)	Nieve (Kg/m ²)
110	80
130	70
150	65

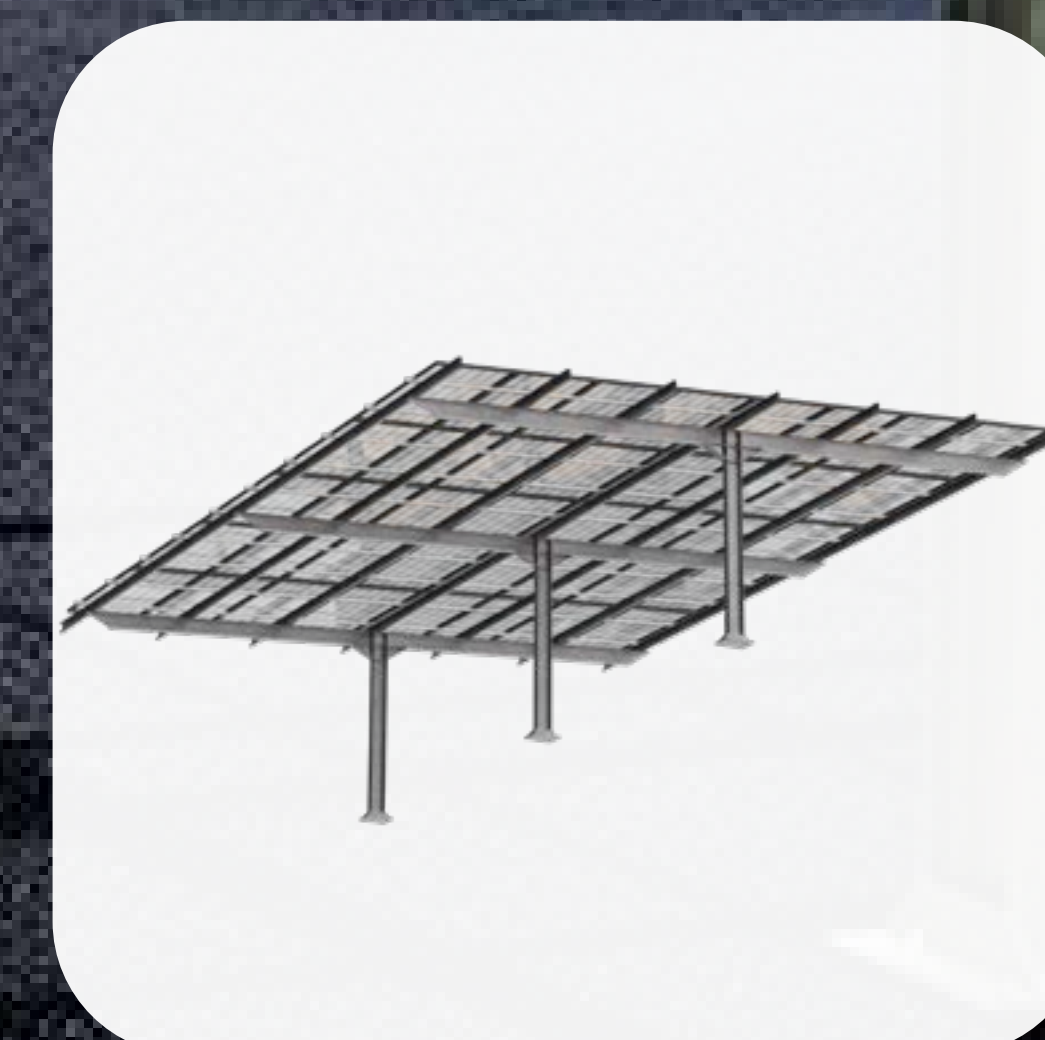

ESPECIFICACIONES

Descripción	Marquesina para aparcamiento con acceso NORTE
Superficie de anclaje	Hormigón
Tornillos de anclaje	Opcional - Acero galvanizado en caliente CP1
Inclinación	5°
Disposición de los módulos	Vertical y Horizontal
Distancia entre pilares	5 m
Kits disponibles	Según proyecto
Tamaño máximo del panel Bulk	2400x1350 mm
Espesor del panel	28-40 mm
Materiales de la estructura principal	Acero galvanizado en caliente grado S275
Tornillos de la estructura principal	Acero inoxidable A2-70
Características de la chapa	Con chapa metálica: Espesor de chapa disponible en: 0,5 mm / 0,63 mm / 0,63 mm anticondensación Sin chapa metálica
Estructuras fotovoltaica con chapa	61H / 62V / 05V / 05.1V
Estructuras fotovoltaica sin chapa	G3
Perfil	Aluminio EN AW 6005 A T6 (en crudo o anodizado)
Tornillería	Acero inoxidable A2-70

COMPONENTES

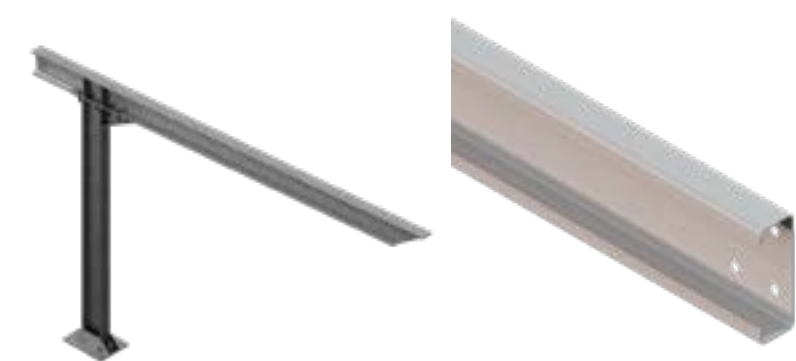

Pilar y vigas



Correas

PIEZAS OPCIONALES



Chapa metálica



CP1

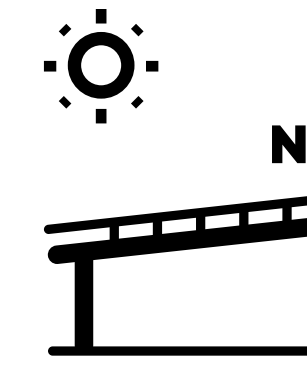

Opción con chapa metálica.



Opción sin chapa metálica.



Formato Bulk

Ver manual montaje
PR1 con chapa

Ver manual montaje
PR1 sin chapa

Simple

PR2

ESPECIFICACIONES

Descripción	Marquesina para aparcamiento con acceso SUR
Superficie de anclaje	Hormigón
Tornillos de anclaje	Opcional - Acero galvanizado en caliente CP1
Inclinación	5°
Disposición de los módulos	Vertical y Horizontal
Distancia entre pilares	5 m
Kits disponibles	Según proyecto
Tamaño máximo del panel Bulk	2400x1350 mm
Espesor del panel	28-40 mm
Materiales de la estructura principal	Acero galvanizado en caliente grado S275
Tornillos de la estructura principal	Acero inoxidable A2-70
Características de la chapa	Con chapa metálica: Espesor de chapa disponible en: 0,5 mm / 0,63 mm / 0,63 mm anticondensación Sin chapa metálica
Estructuras fotovoltaica con chapa	61H / 62V / 05V / 05.1V
Estructuras fotovoltaica sin chapa	G3
Perfil	Aluminio EN AW 6005 A T6 (en crudo o anodizado)
Tornillería	Acero inoxidable A2-70

COMPONENTES

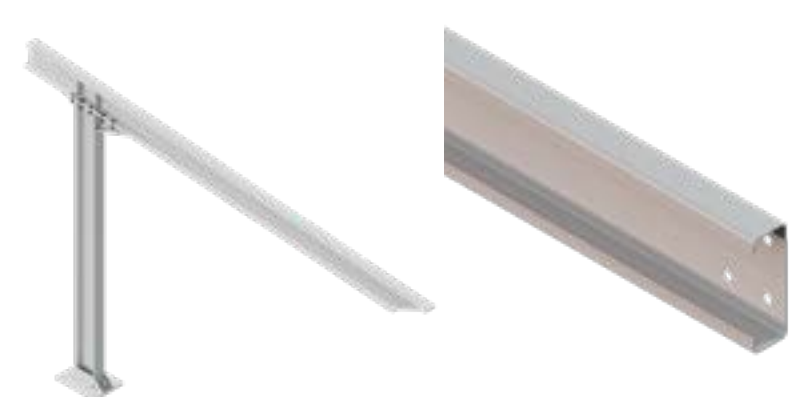

Pilar y vigas Correas

PIEZAS OPCIONALES



Chapa metálica CP1

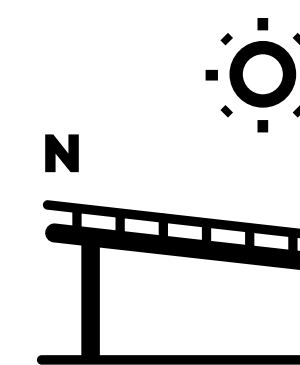

Opción con chapa metálica.



Opción sin chapa metálica.



Formato Bulk

Ver manual montaje
PR2 con chapa

Ver manual montaje
PR2 sin chapa

Doble

PR3

ESPECIFICACIONES

Descripción	Marquesina para aparcamiento doble acceso
Superficie de anclaje	Hormigón
Tornillos de anclaje	Opcional - Acero galvanizado en caliente CP1
Inclinación	5°
Disposición de los módulos	Vertical y Horizontal
Distancia entre pilares	5 m
Kits disponibles	Según proyecto
Tamaño máximo del panel Bulk	2400x1350 mm
Espesor del panel	28-40 mm
Materiales de la estructura principal	Acero galvanizado en caliente grado S275
Tornillos de la estructura principal	Acero inoxidable A2-70
Características de la chapa	Con chapa metálica: Espesor de chapa disponible en: 0,5 mm / 0,63 mm / 0,63 mm anticondensación Sin chapa metálica
Estructuras fotovoltaica con chapa	61H / 62V / 05V / 05.1V
Estructuras fotovoltaica sin chapa	G3
Perfil	Aluminio EN AW 6005 A T6 (en crudo o anodizado)
Tornillería	Acero inoxidable A2-70

COMPONENTES

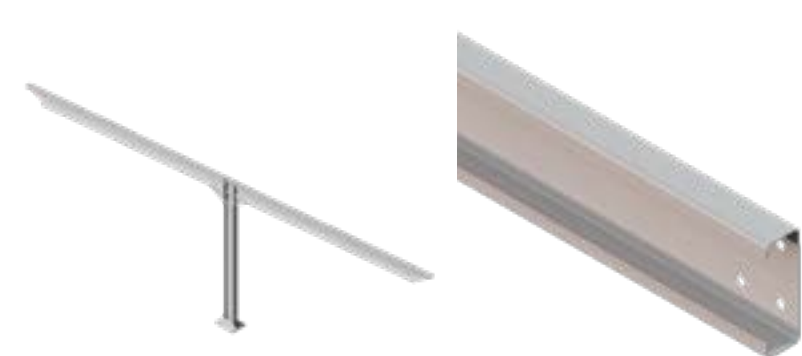

Pilar y vigas Correas

PIEZAS OPCIONALES



Chapa metálica CP1

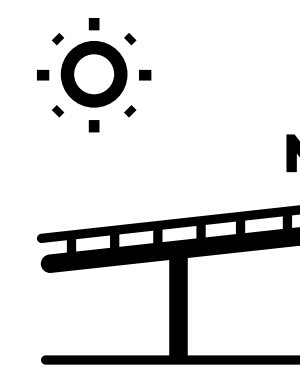

Opción con chapa metálica.



Opción sin chapa metálica.



Formato Bulk

Ver manual montaje
PR3 con chapa

Ver manual montaje
PR3 sin chapa

ESPECIFICACIONES

Superficie de instalación	Terreno
Superficie de anclaje	Cimientos de hormigón
Tornillos de anclaje	Opcional - Acero galvanizado en caliente
Inclinación	8°
Disposición del módulo	Vertical
Distancia entre pilares	5 - 7,5 m
Kits disponibles	2-3-4-5 Aparcamientos
Tamaño máximo del panel Bulk	1762x1150 mm
Espesor del panel	30-40 mm
Materiales de la estructura principal	Acero galvanizado en caliente grado S275
Tornillería estructura principal	Acero inoxidable A2-70
Características de la chapa	Sin Chapa metálica
Perfil	Aluminio Pintado 6063 T5
Tornillos	Acero inoxidable A2-70
Estructura fotovoltaica sin chapa	G3
Perfil	Aluminio EN AW 6005 A T6 (Crudo o anodizado)

COMPONENTES



Pilares y Vigas

Correas



Formato Bulk

[Ver manual montaje](#)

Subestructuras

Cubiertas metálicas

Carril continuo
Fijaciones a correas

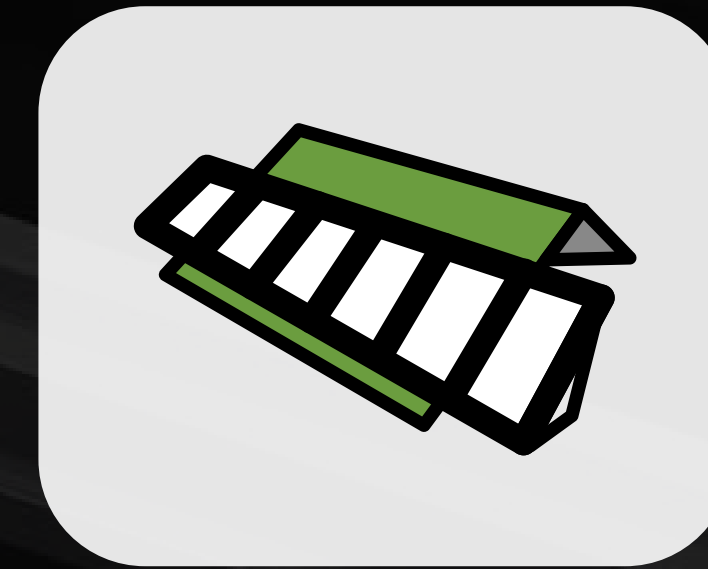

08V | 09V

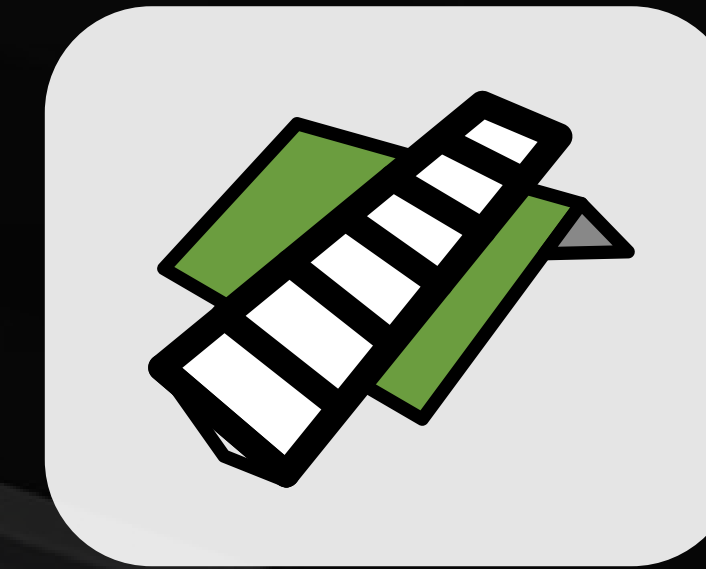

10V | 11V

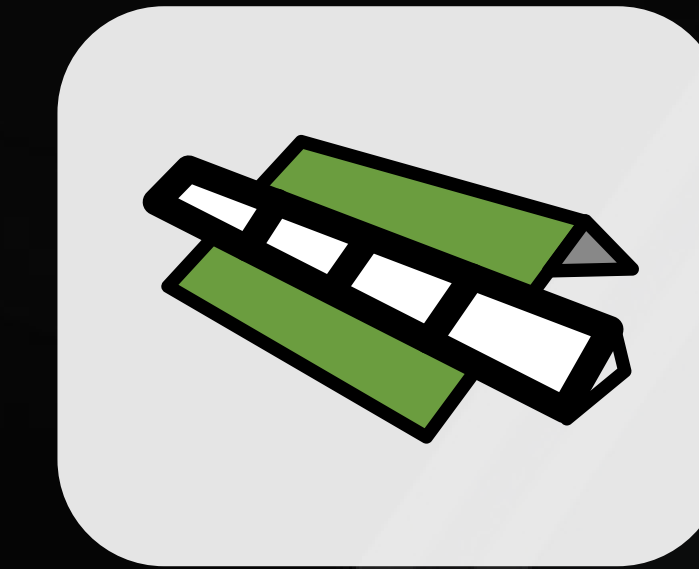

19H

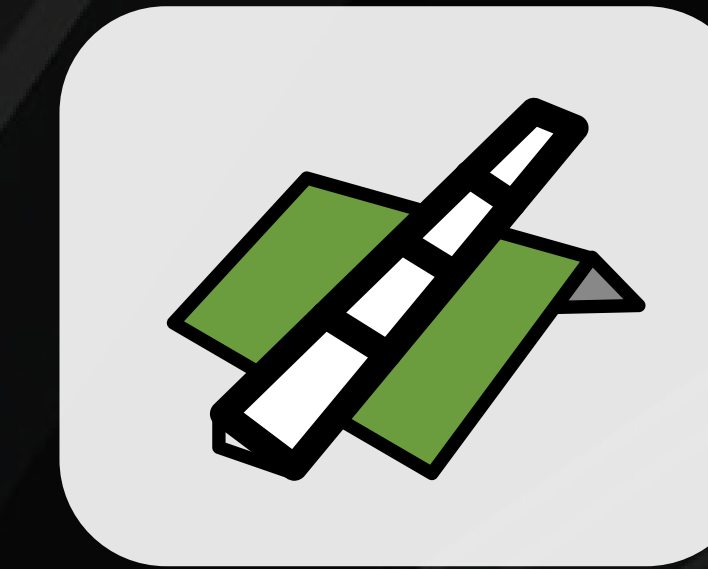

20H

Micro-rail
Fijaciones a chapa

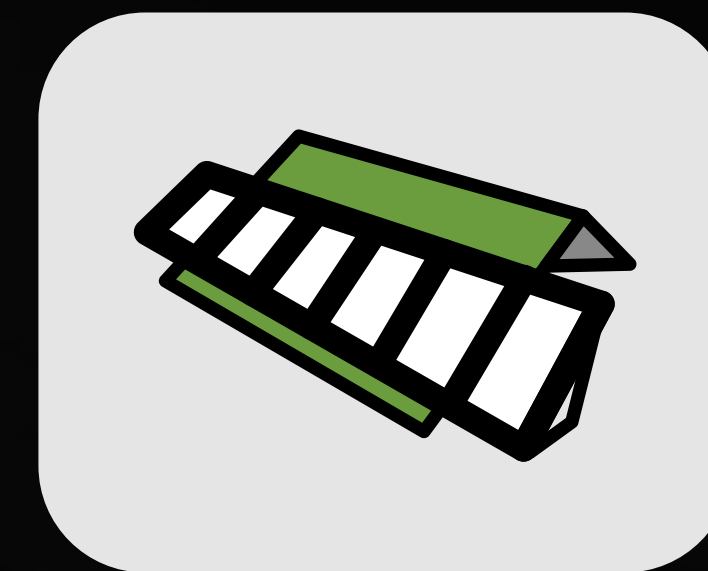

10V | 11V | 13V
+S37
+S38

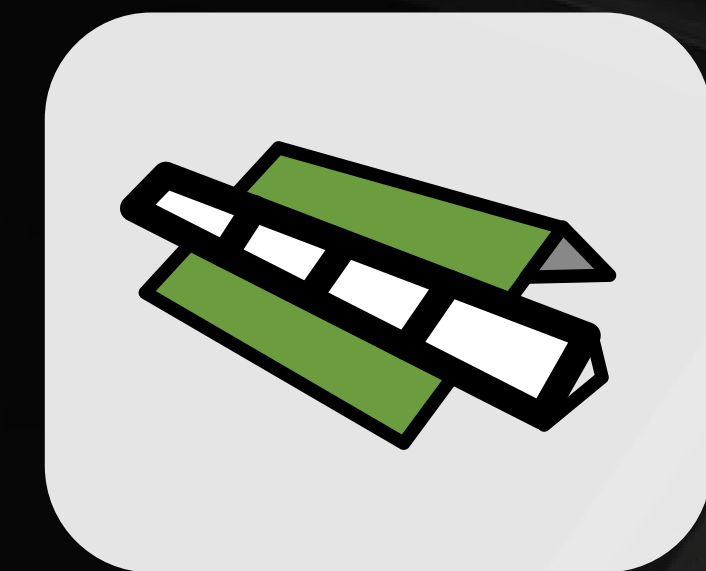

20H
+S37
+S38

Cubiertas de hormigón

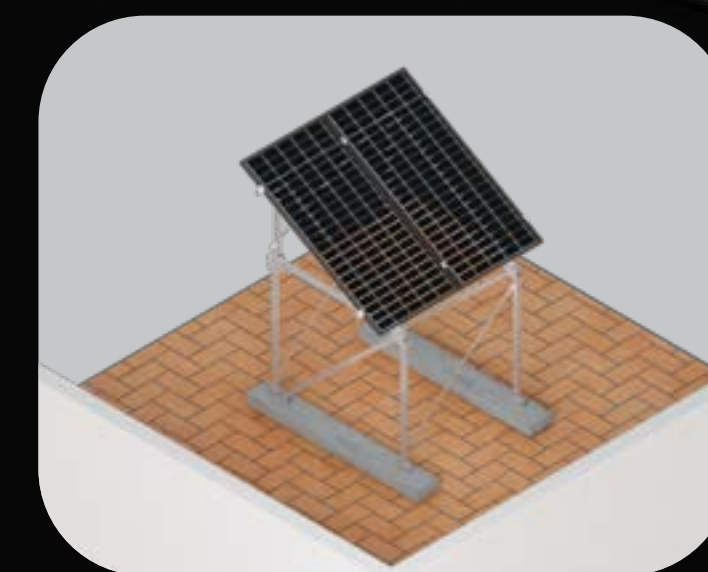

41V



41H



❌ FIJACIÓN ERRÓNEA

Triángulos anclados mediante subestructura

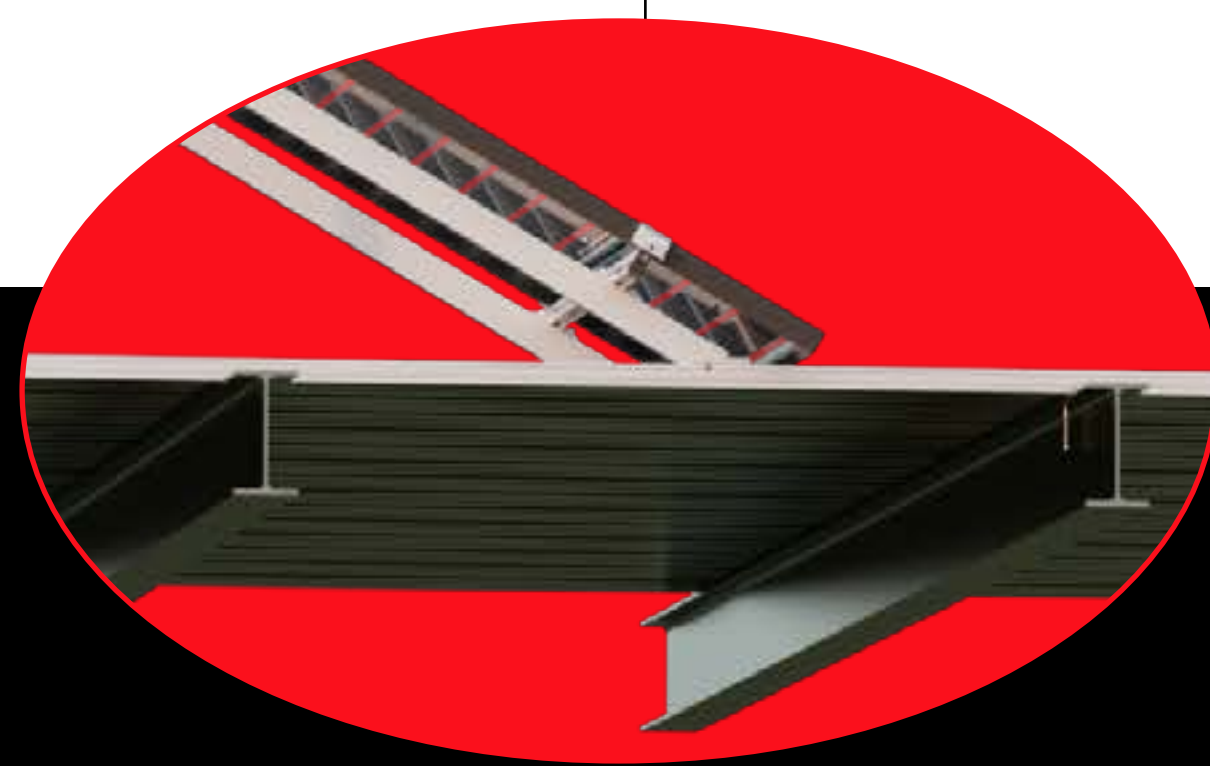
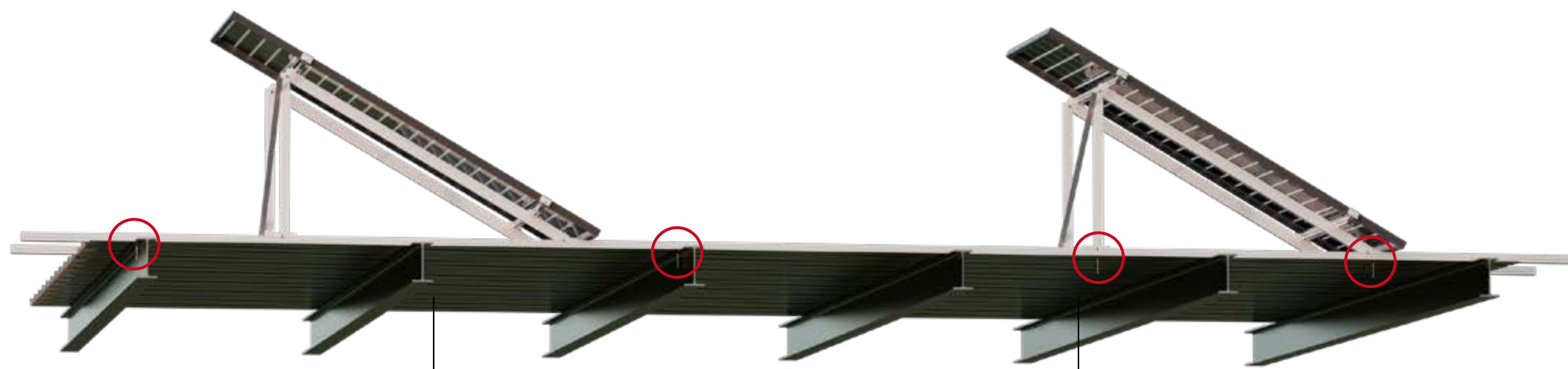

Subestructura no anclada a todas las correas disponibles

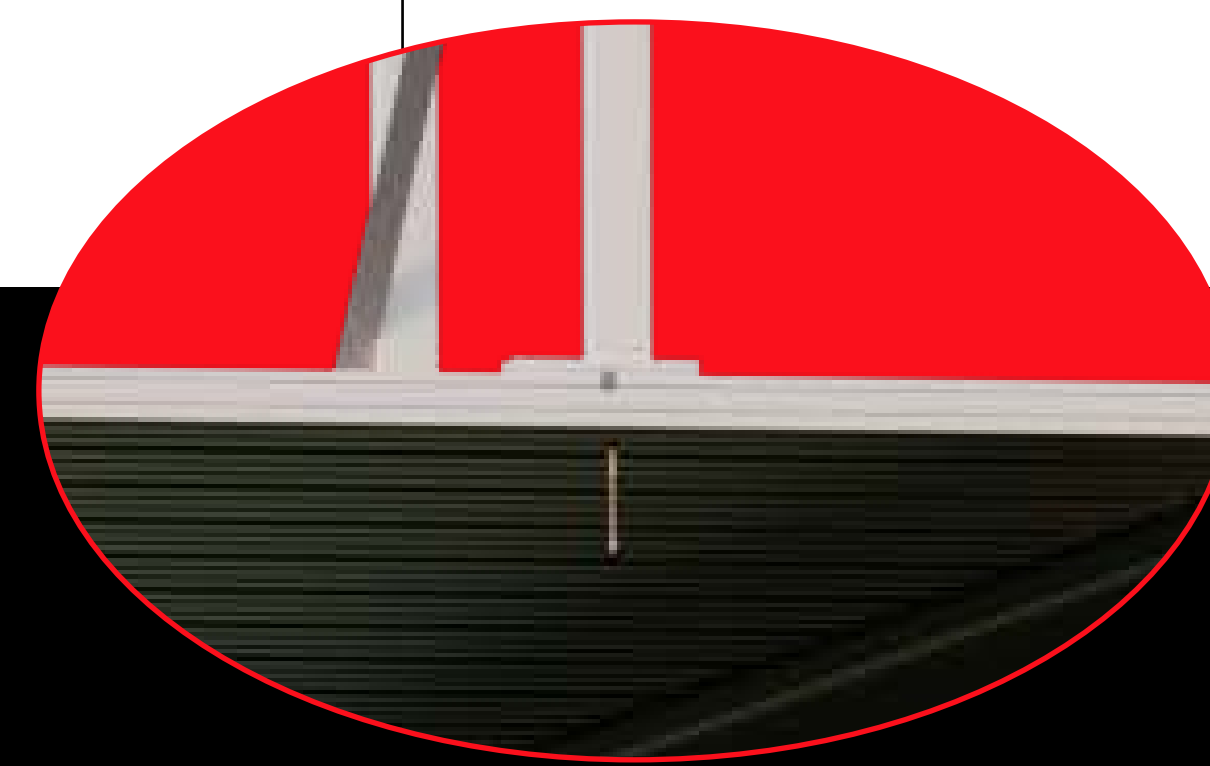

Subestructura anclada fuera de las correas

✅ FIJACIÓN CORRECTA

Triángulos anclados mediante subestructura

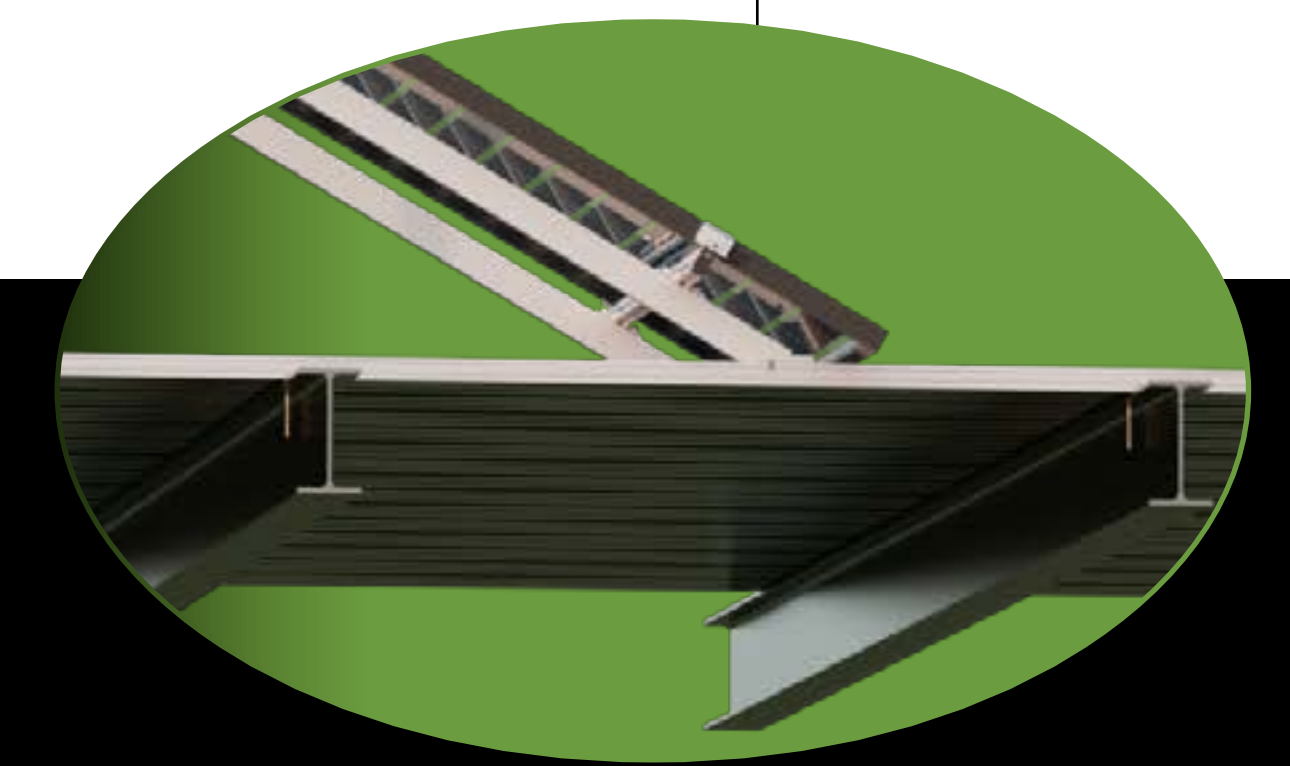
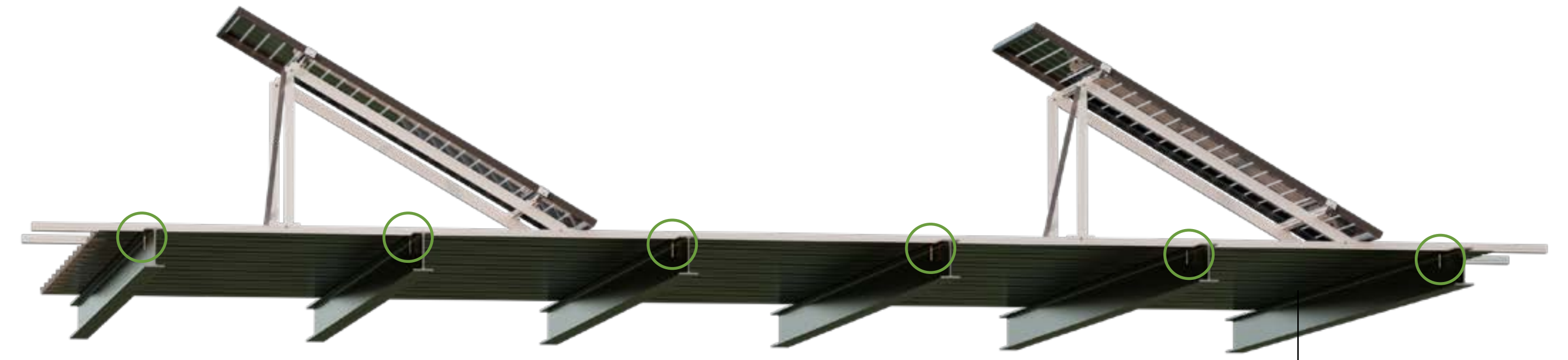

Subestructura anclada a todas las correas disponibles

ESPECIFICACIONES

Sin tornillo de cosido (Distancia máxima mm)

Perfil	Grados	Velocidad máxima del viento		
		110km/h	130km/h	150km/h
G3	15°	1700	1550	1350
	30°	1800	1450	1200
G4	15°	2500	2500	2400
	30°	2500	2400	2300

Con tornillo de cosido* (Distancia máxima mm)

Perfil	Grados	Velocidad máxima del viento		
		110km/h	130km/h	150km/h
G3	15°	2200	2000	1750
	30°	2000	1750	1600
G4	15°	2500	2500	2500
	30°	2500	2500	2500

Tornillo de cosido*

Tornillería zincada	S42.1
Tornillería bimetálica	S43

Junta de estanqueidad

Continua	S46.2
Discontinua	S46

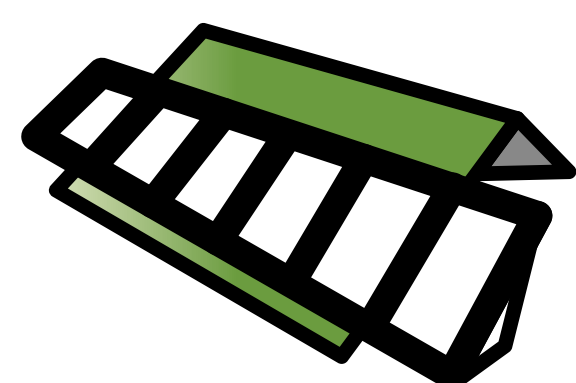

Disposición vertical con perfiles paralelos a la cumbrera

*La distancia entre tornillos de cosido debe ser de 50 cm.

Importante:

Verifique el estado y la capacidad portante de la chapa y de la estructura portante de la cubierta.

Distancias válidas para tornillería Sunfer, consulte la tornillería de anclaje en el apartado Packaging.

Válido para formato Kit y Bulk, siempre que se mantengan las mismas condiciones de diseño del kit (velocidad del viento, carga de nieve, distancia entre triángulos, etc.).

Perfil G3



Perfil G4



Para el perfil G4 se debe disponer de un tornillo de cosido y de fijación a correas en cada ala del perfil.

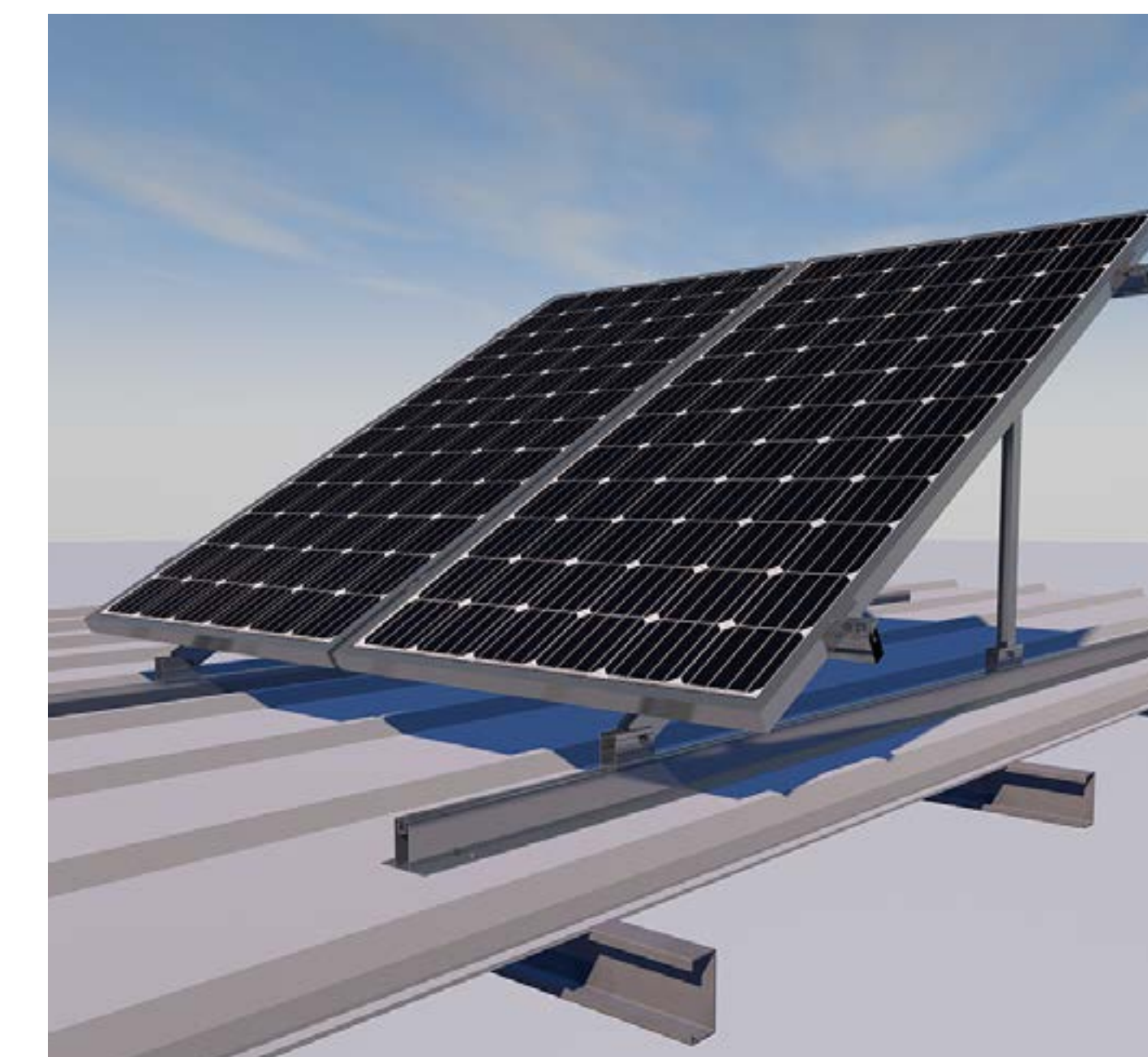
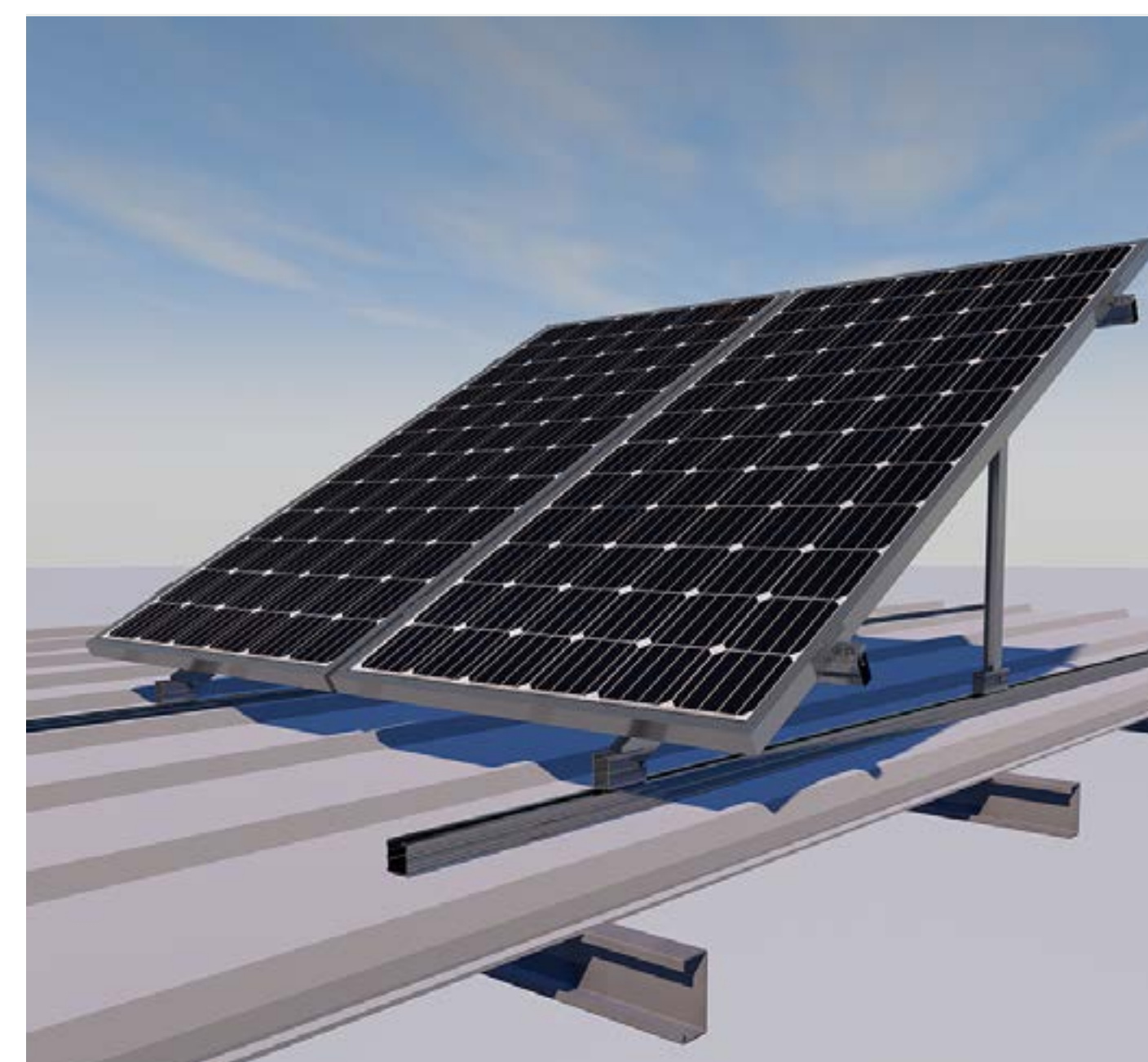

No válido para cubiertas sin chapa. Sunfer no se responsabiliza del uso de productos ajenos.



Cálculo para 40 Kg/m² de nieve



La subestructura debe ser anclada a todas las correas presentes aunque la distancia entre anclajes sea menor a la indicada.

Para distancias entre correas superiores consultar al Dpto. de proyectos de Sunfer.



Formato Bulk

[Ver Vídeo](#)

[Ver manual de montaje Kit 08V](#)

[Ver manual de montaje Kit 09V](#)

ESPECIFICACIONES

Sin tornillo de cosido (Distancia máxima mm)

Perfil	Grados	Velocidad máxima del viento		
		110km/h	130km/h	150km/h
G3	15°	1800	1550	1350
	30°	1300	1100	700
G4	15°	2500	2500	2250
	30°	1550	1450	900

Con tornillo de cosido* (Distancia máxima mm)

Perfil	Grados	Velocidad máxima del viento		
		110km/h	130km/h	150km/h
G3	15°	1900	1700	1600
	30°	1650	1450	1200
G4	15°	2500	2500	2500
	30°	2500	2500	2500

Tornillo de cosido*

Tornillería zincada	S42.1
Tornillería bimetálica	S43

Junta de estanqueidad

Continua	S46.2
Discontinua	S46

*La distancia entre tornillos de cosido debe ser de 50 cm.

Importante:

Verifique el estado y la capacidad portante de la chapa y de la estructura portante de la cubierta.

Distancias válidas para tornillería Sunfer, consulte la tornillería de anclaje en el apartado Packaging.

Válido para formato Kit y Bulk, siempre que se mantengan las mismas condiciones de diseño del kit (velocidad del viento, carga de nieve, distancia entre triángulos, etc.).

Disposición vertical con perfiles perpendiculares a la cumbrera

Perfil G3

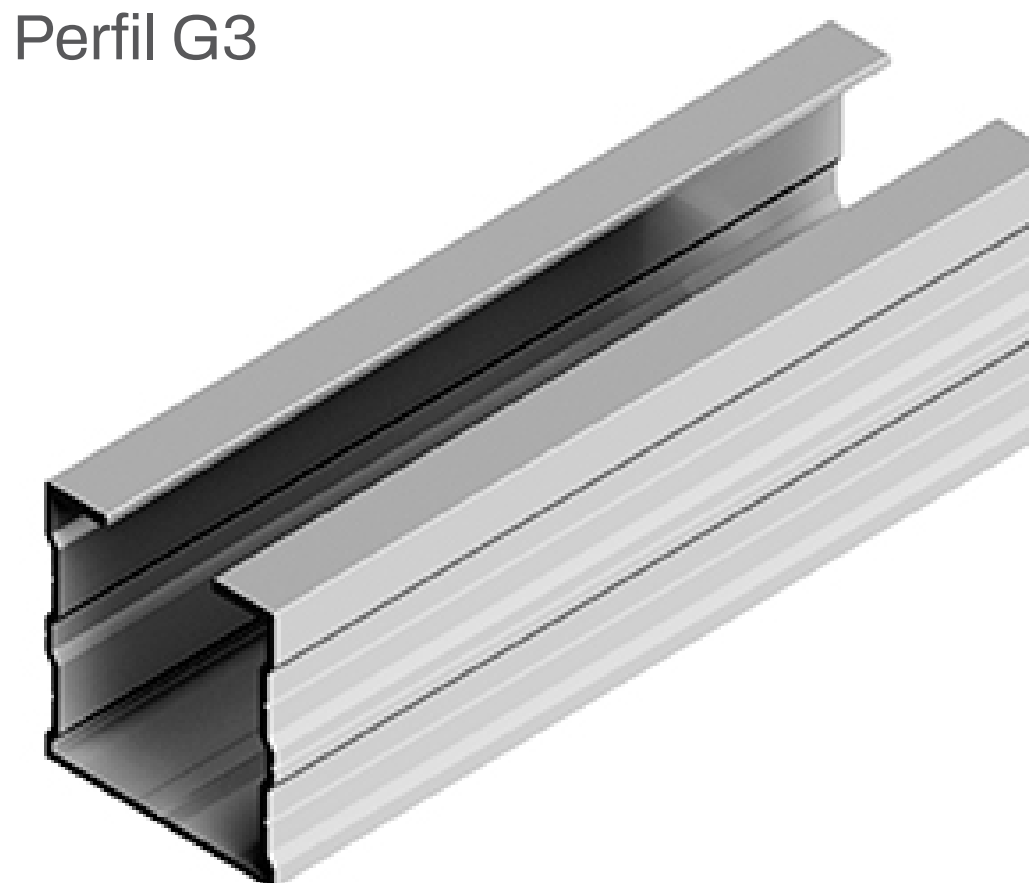

Perfil G4



Para el perfil G4 se debe disponer de un tornillo de cosido y de fijación a correas en cada ala del perfil.



No válido para cubiertas sin chapa. Sunfer no se responsabiliza del uso de productos ajenos.

 Cálculo para 40 Kg/m² de nieve

 La subestructura debe ser anclada a todas las correas presentes aunque la distancia entre anclajes sea menor a la indicada.

Para distancias entre correas superiores consultar al Dpto. de proyectos de Sunfer.



Formato Bulk

[Ver Vídeo](#)

[Ver manual de montaje 10V](#)

[Ver manual de montaje 11V](#)

ESPECIFICACIONES

Sin tornillo de cosido (Distancia máxima mm)

Perfil	Grados	Velocidad máxima del viento		
		110km/h	130km/h	150km/h
G3	15°	2500	2350	2100
	30°	2300	2150	2000
G4	15°	2500	2500	2500
	30°	2500	2500	2400

Con tornillo de cosido* (Distancia máxima mm)

Perfil	Grados	Velocidad máxima del viento		
		110km/h	130km/h	150km/h
G3	15°	2500	2500	2500
	30°	2500	2500	2500
G4	15°	2500	2500	2500
	30°	2500	2500	2500

Tornillo de cosido*

Tornillería zincada	S42.1
Tornillería bimetálica	S43

Junta de estanqueidad

Continua	S46.2
Discontinua	S46

*La distancia entre tornillos de cosido debe ser de 50 cm.

Importante:

Verifique el estado y la capacidad portante de la chapa y de la estructura portante de la cubierta.

Distancias válidas para tornillería Sunfer, consulte la tornillería de anclaje en el apartado Packaging.

Válido para formato Kit y Bulk, siempre que se mantengan las mismas condiciones de diseño del kit (velocidad del viento, carga de nieve, distancia entre triángulos, etc.).

Disposición horizontal con perfiles paralelos a la cumbre

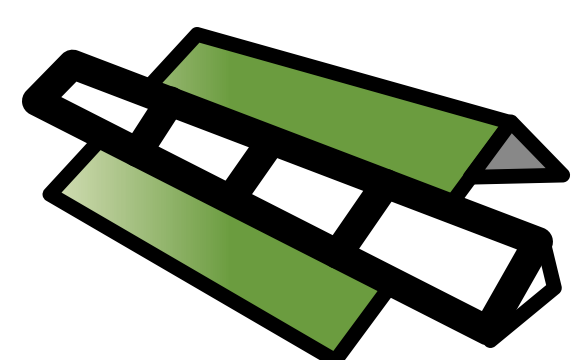

Perfil G3



Perfil G4



Para el perfil G4 se debe disponer de un tornillo de cosido y de fijación a correas en cada ala del perfil.

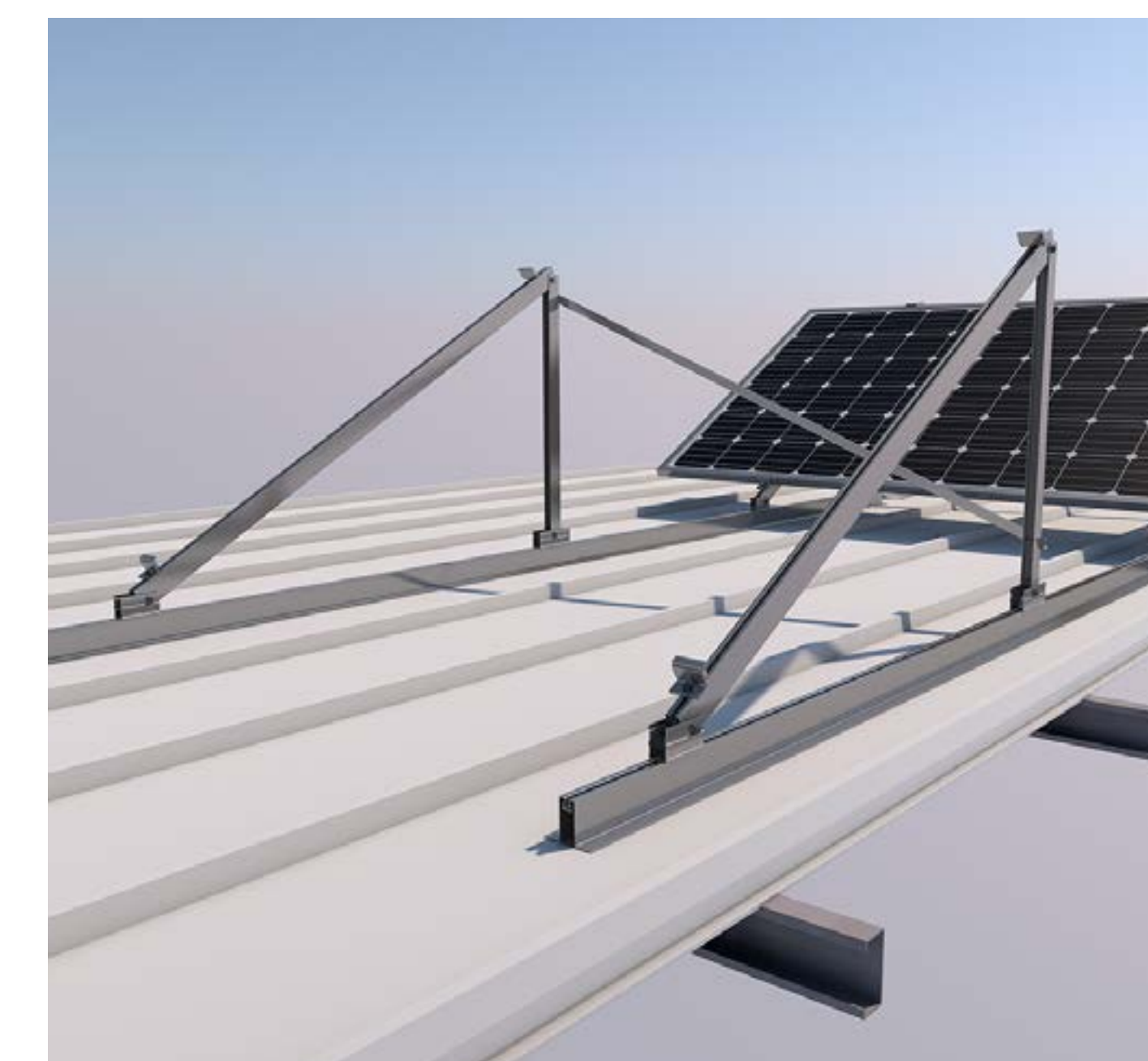

No válido para cubiertas sin chapa. Sunfer no se responsabiliza del uso de productos ajenos.

Cálculo para 40 Kg/m² de nieve

La subestructura debe ser anclada a todas las correas presentes aunque la distancia entre anclajes sea menor a la indicada.

Para distancias entre correas superiores consultar al Dpto. de proyectos de Sunfer.



Formato Bulk

Ver Vídeo

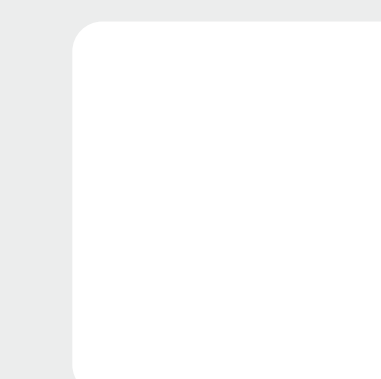

Ver manual de montaje

ESPECIFICACIONES

Sin tornillo de cosido (Distancia máxima mm)

Perfil	Grados	Velocidad máxima del viento		
		110km/h	130km/h	150km/h
G3	15°	2200	2000	1900
	30°	2000	1900	1800
G4	15°	2500	2500	2500
	30°	2500	2500	2450

Con tornillo de cosido* (Distancia máxima mm)

Perfil	Grados	Velocidad máxima del viento		
		110km/h	130km/h	150km/h
Bulk System	15°	2500	2500	2500
	30°	2500	2500	2500
G4	15°	2500	2500	2500
	30°	2500	2500	2500

Tornillo de cosido*

Tornillería zincada	S42.1
Tornillería bimetálica	S43

Junta de estanqueidad

Continua	S46.2
Discontinua	S46

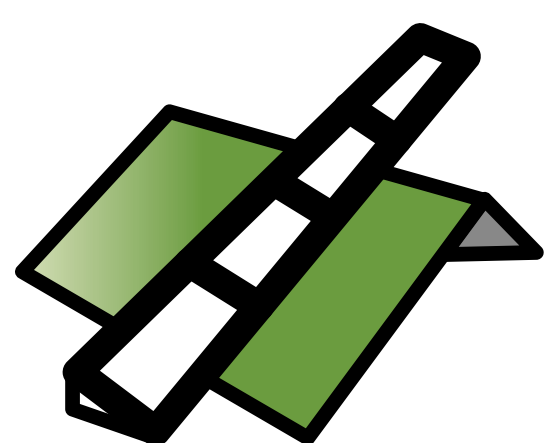

Disposición horizontal con perfiles perpendiculares a la cumbrera

*La distancia entre tornillos de cosido debe ser de 50 cm.

Importante:

Verifique el estado y la capacidad portante de la chapa y de la estructura portante de la cubierta.

Distancias válidas para tornillería Sunfer, consulte la tornillería de anclaje en el apartado Packaging.

Válido para formato Kit y Bulk, siempre que se mantengan las mismas condiciones de diseño del kit (velocidad del viento, carga de nieve, distancia entre triángulos, etc.).

Perfil G3



Perfil G4



Para el perfil G4 se debe disponer de un tornillo de cosido y de fijación a correas en cada ala del perfil.

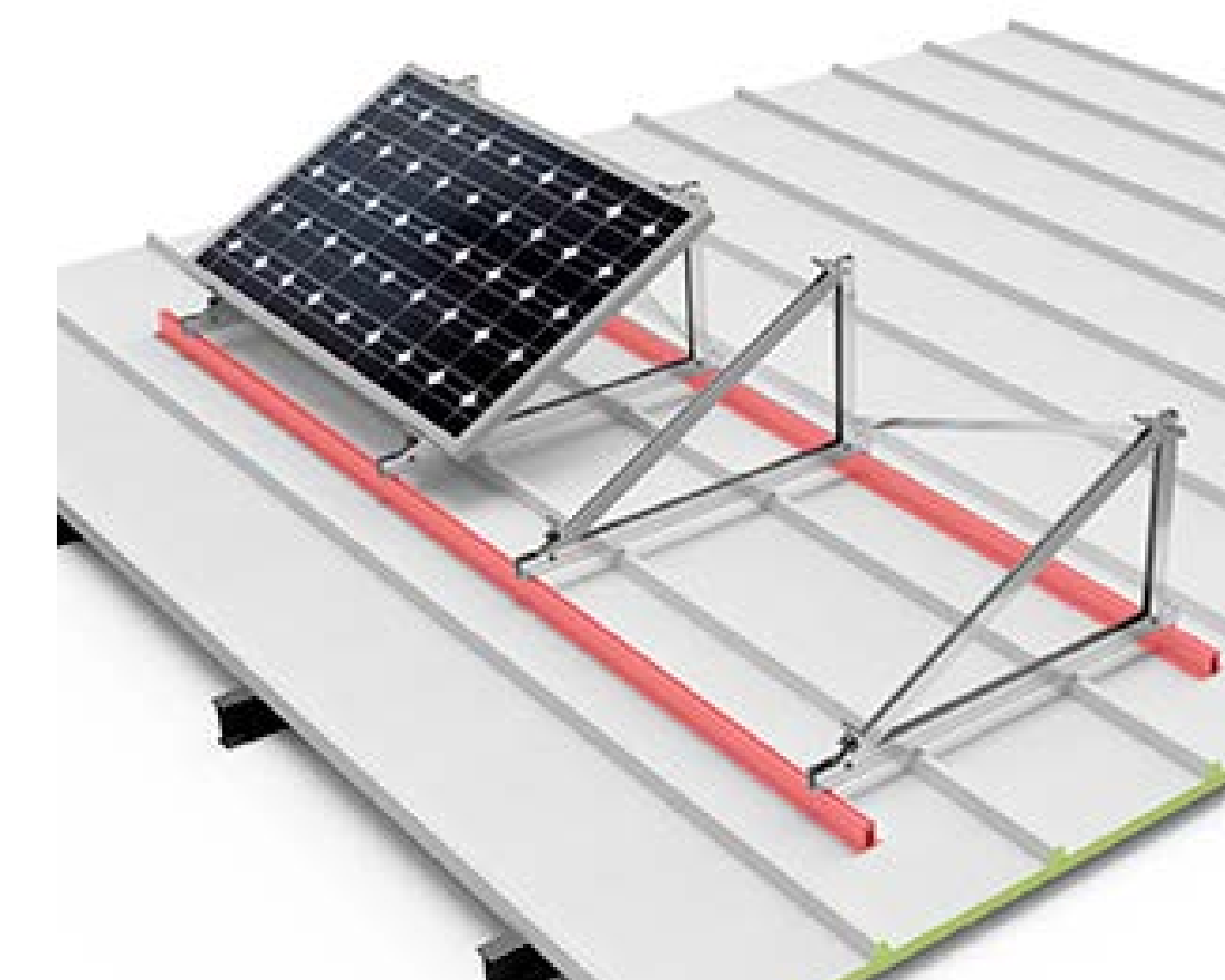
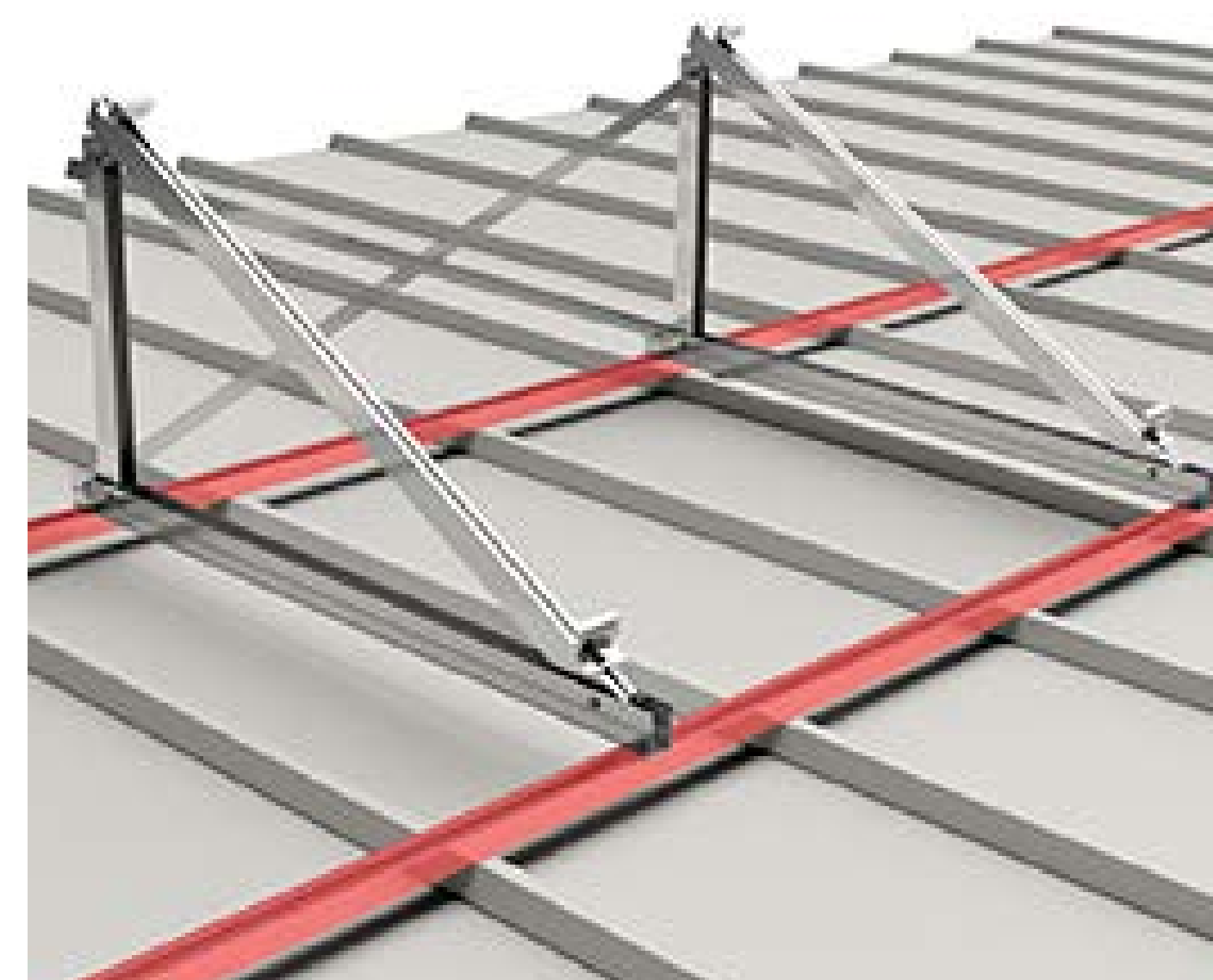

No válido para cubiertas sin chapa. Sunfer no se responsabiliza del uso de productos ajenos.



Cálculo para 40 Kg/m² de nieve



La subestructura debe ser anclada a todas las correas presentes aunque la distancia entre anclajes sea menor a la indicada.

Para distancias entre correas superiores consultar al Dpto. de proyectos de Sunfer.



Formato Bulk

[Ver Vídeo](#)

[Ver manual de montaje](#)

Son siempre necesarias 2 unidades por triángulo

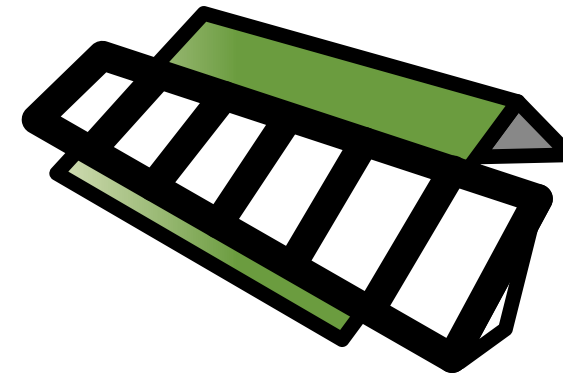

Disposición vertical con perfiles paralelos a la cumbre

S37

COMPONENTES POR UNIDAD



S37

COMPONENTES POR UNIDAD

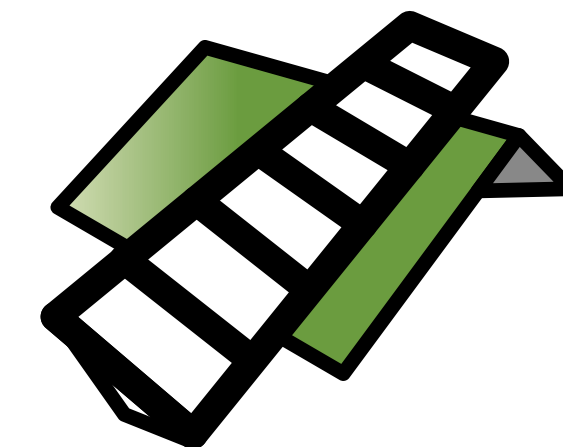
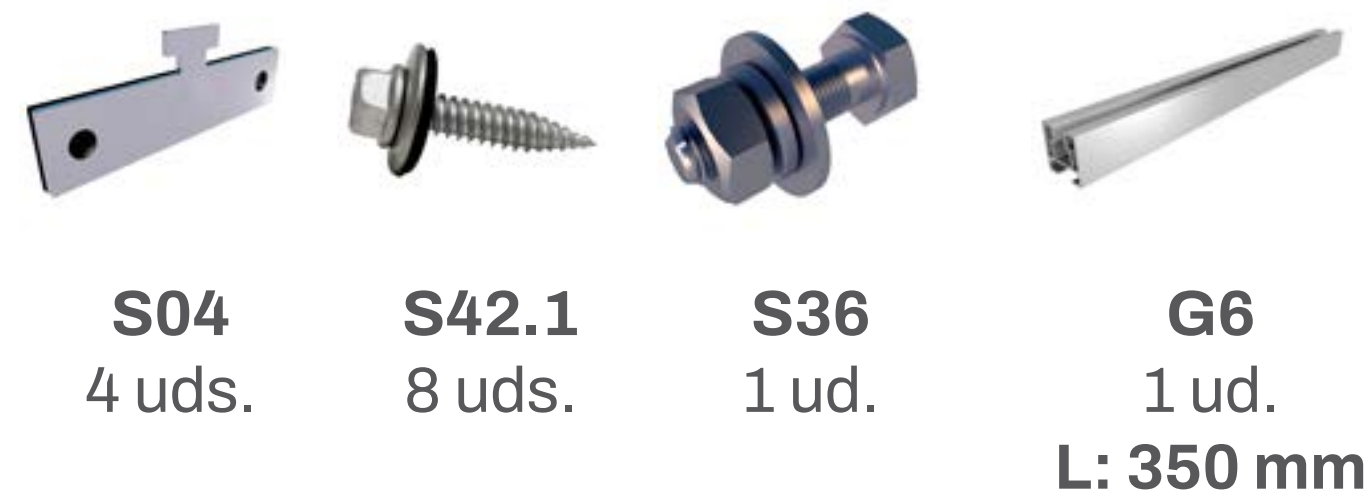

Disposición vertical con perfiles perpendiculares a la cumbre

S38

COMPONENTES POR UNIDAD

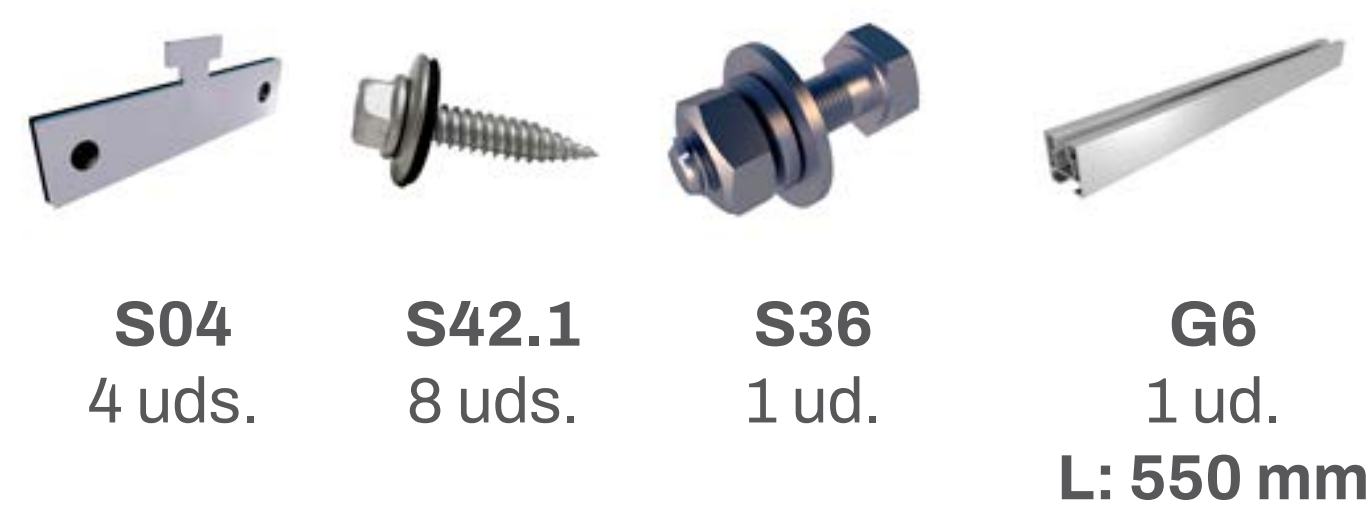

S38

COMPONENTES POR UNIDAD

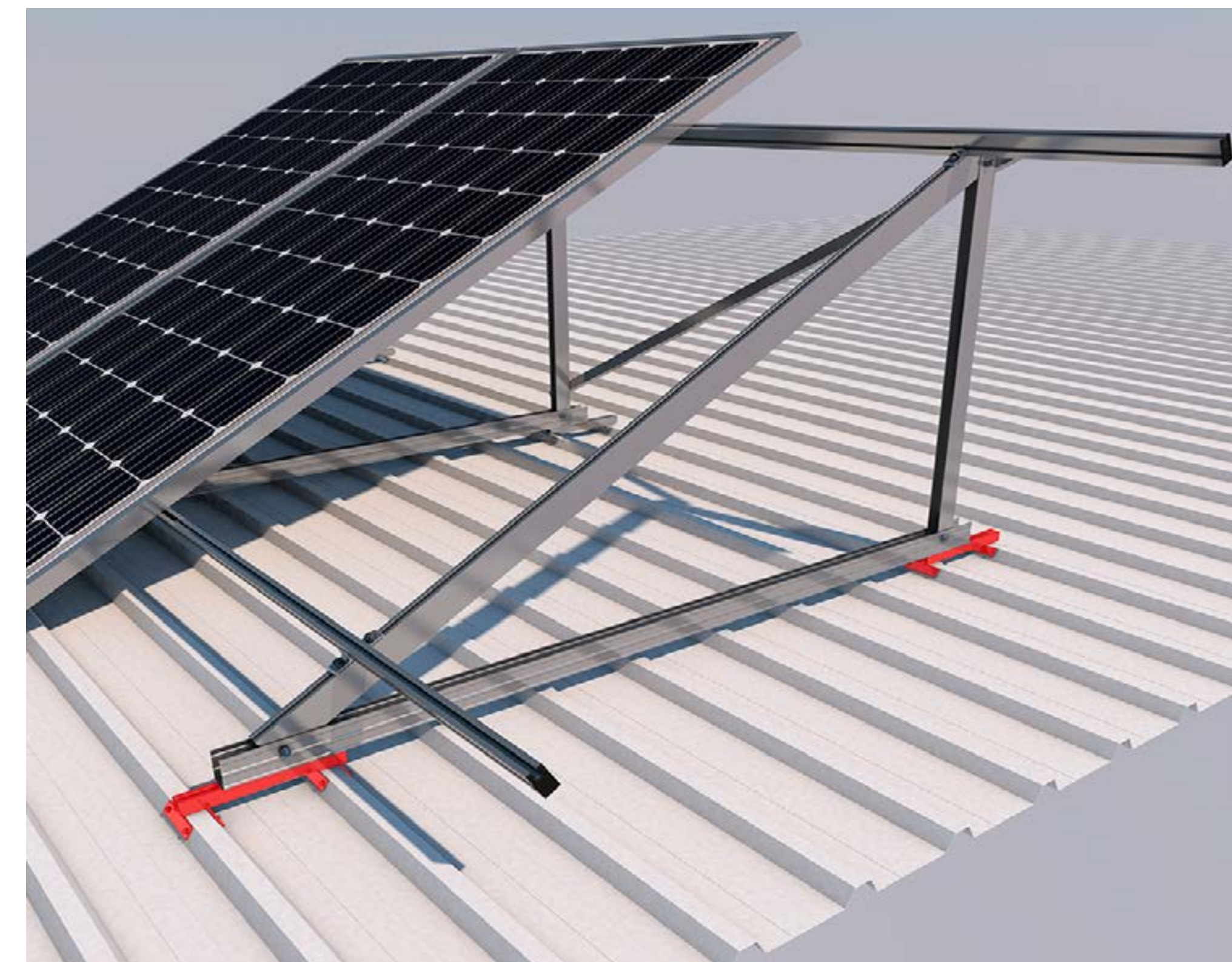

Formato Bulk

[Ver Vídeo 10V/11V](#)

[Ver Vídeo 13V](#)



[Ver manual de montaje 10V](#)



[Ver manual de montaje 11V](#)



[Ver manual de montaje 13V](#)

Micro-rail 20H

Son siempre necesarias 2 unidades por triángulo

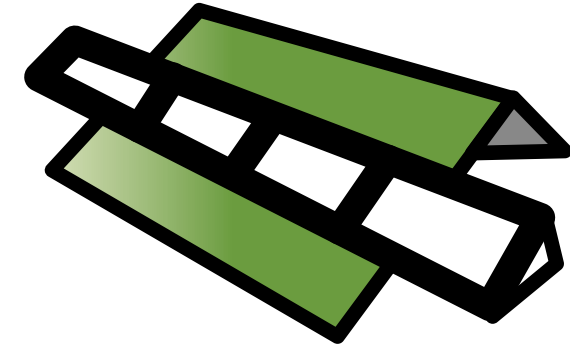

Disposición horizontal con perfiles paralelos a la cumbre

S37

COMPONENTES POR UNIDAD



S38

COMPONENTES POR UNIDAD

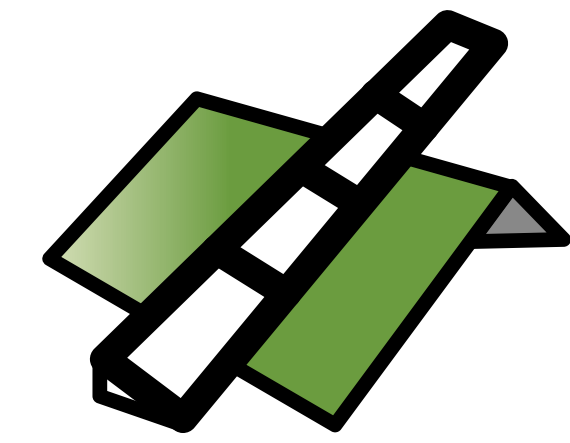
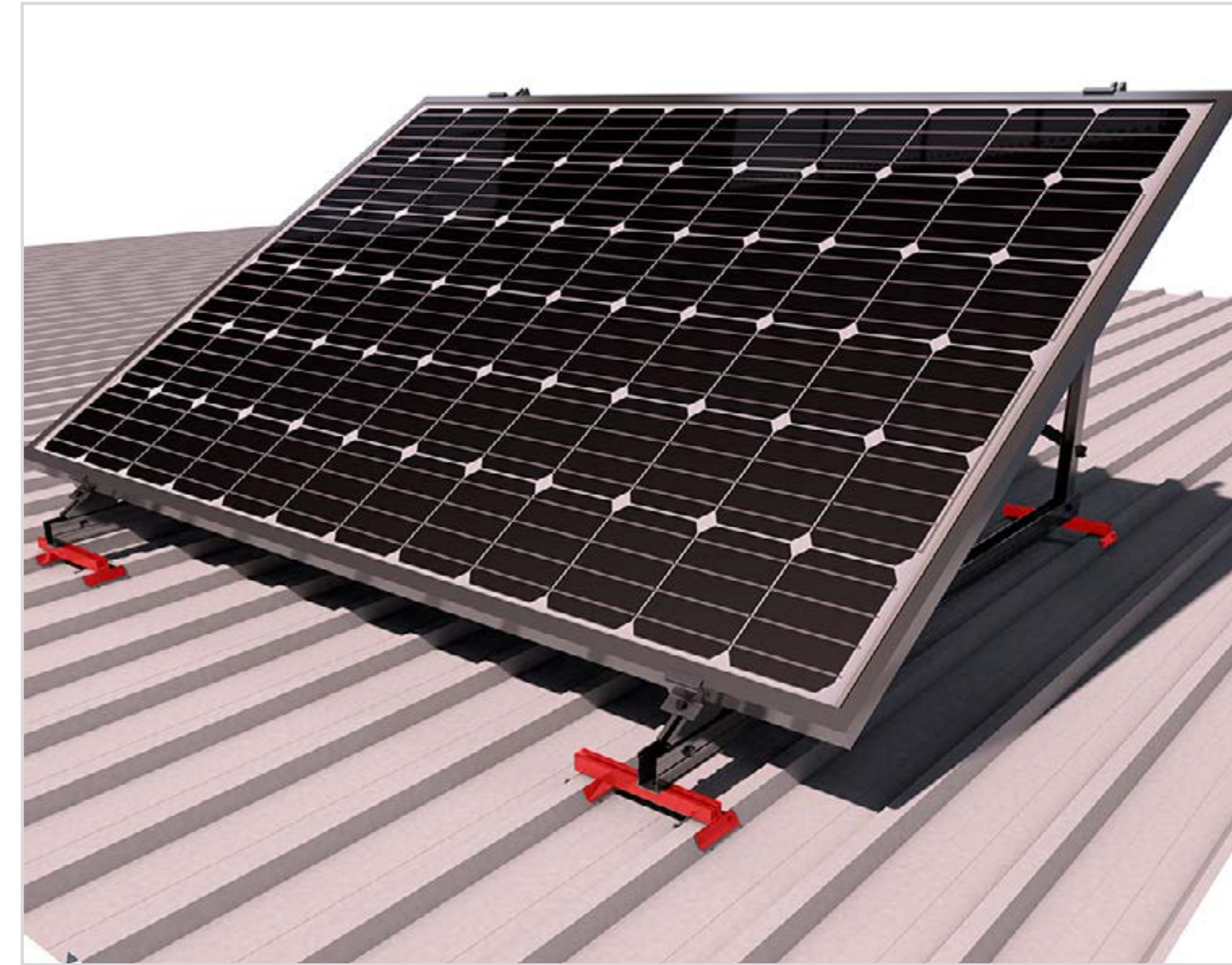
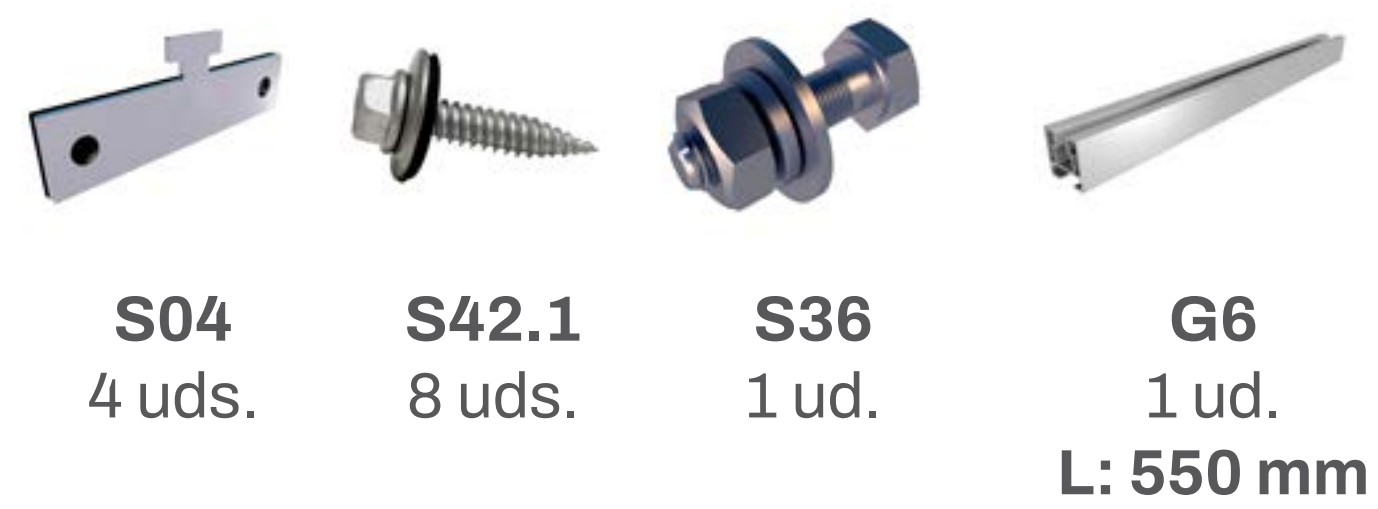

Disposición horizontal con perfiles perpendiculares a la cumbre

S37

COMPONENTES POR UNIDAD



S38

COMPONENTES POR UNIDAD

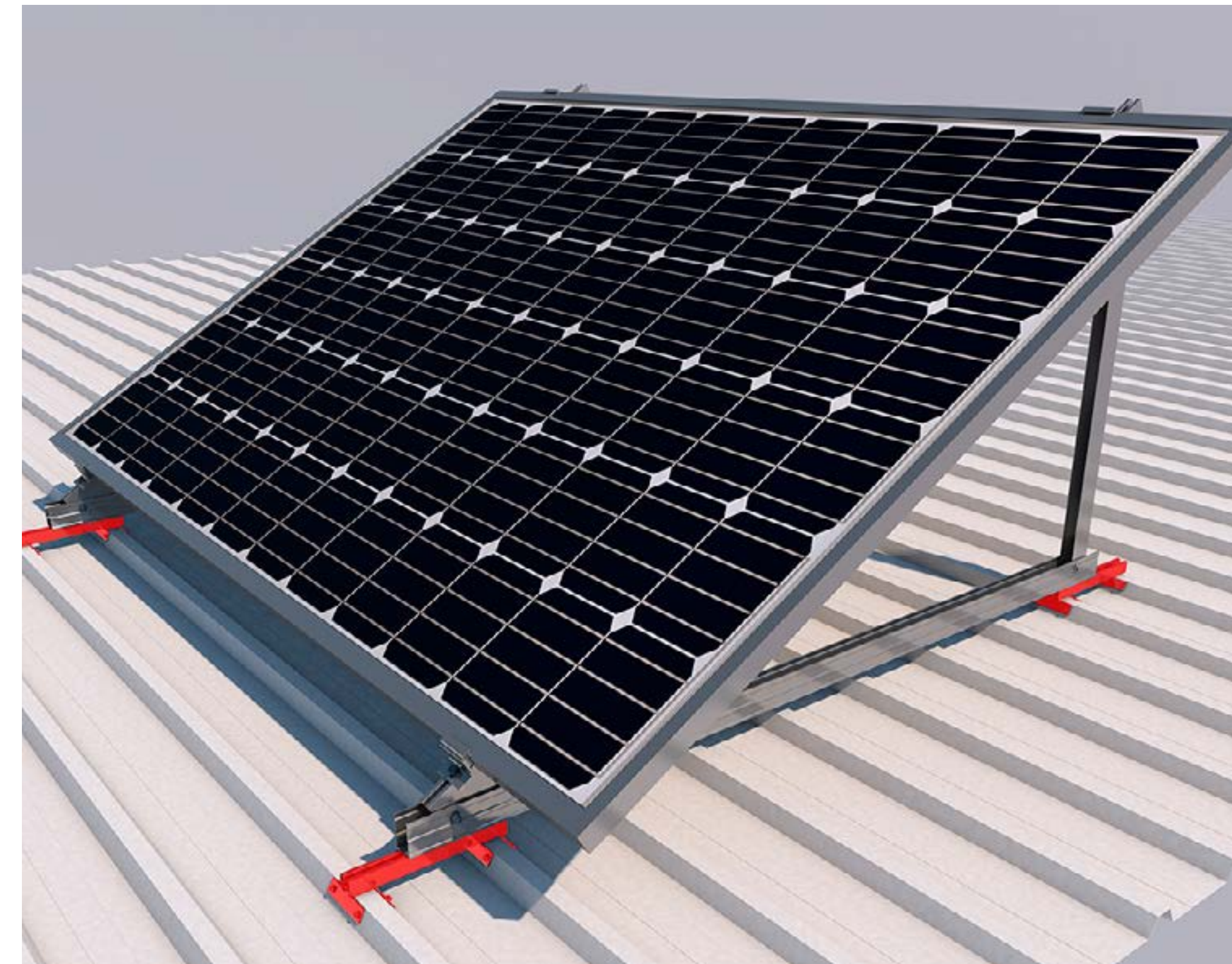
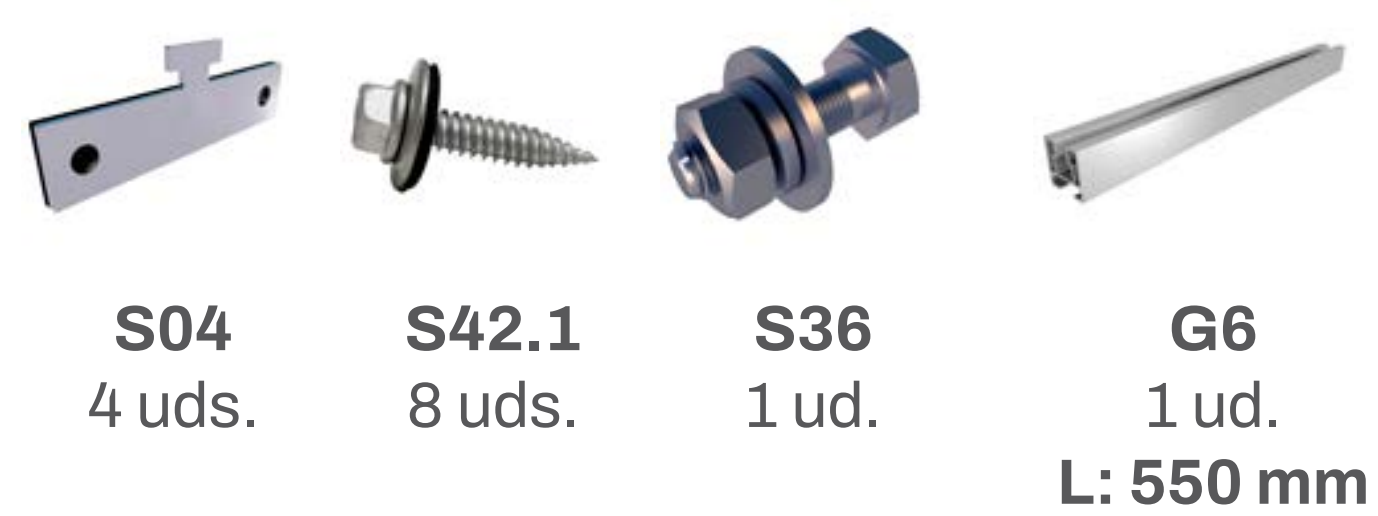

Formato Bulk

[Ver Vídeo 20H](#)

[Ver manual de montaje 20H](#)

ESPECIFICACIONES

Superficie de instalación	Cubierta plana
Superficie de anclaje	Anclaje a cubierta de hormigón o losa de hormigón continua
Tornillería de anclaje	Incluye tornillería de anclaje de triángulos a 41V
Altura	500 mm 1000 mm 1500 mm
Disposición del módulo	Compatible con estructuras para módulos en vertical u horizontal
Tamaño máximo del panel	Dependerá de la estructura base
Espesor del panel	28-40 mm
Perfilería	Aluminio EN AW-6005A T6 (Crudo o anodizado)
Tornillería	Acero inoxidable A2-70



⚠ Información importante:

Por cada triángulo es necesario 1 Ud. de 41V.

Independientemente de los módulos y de los triángulos solo será necesario un kit de arriostramiento 41VD por cada fila o mesa.

Bordillos no incluidos.
Soporte inclinado no incluido.

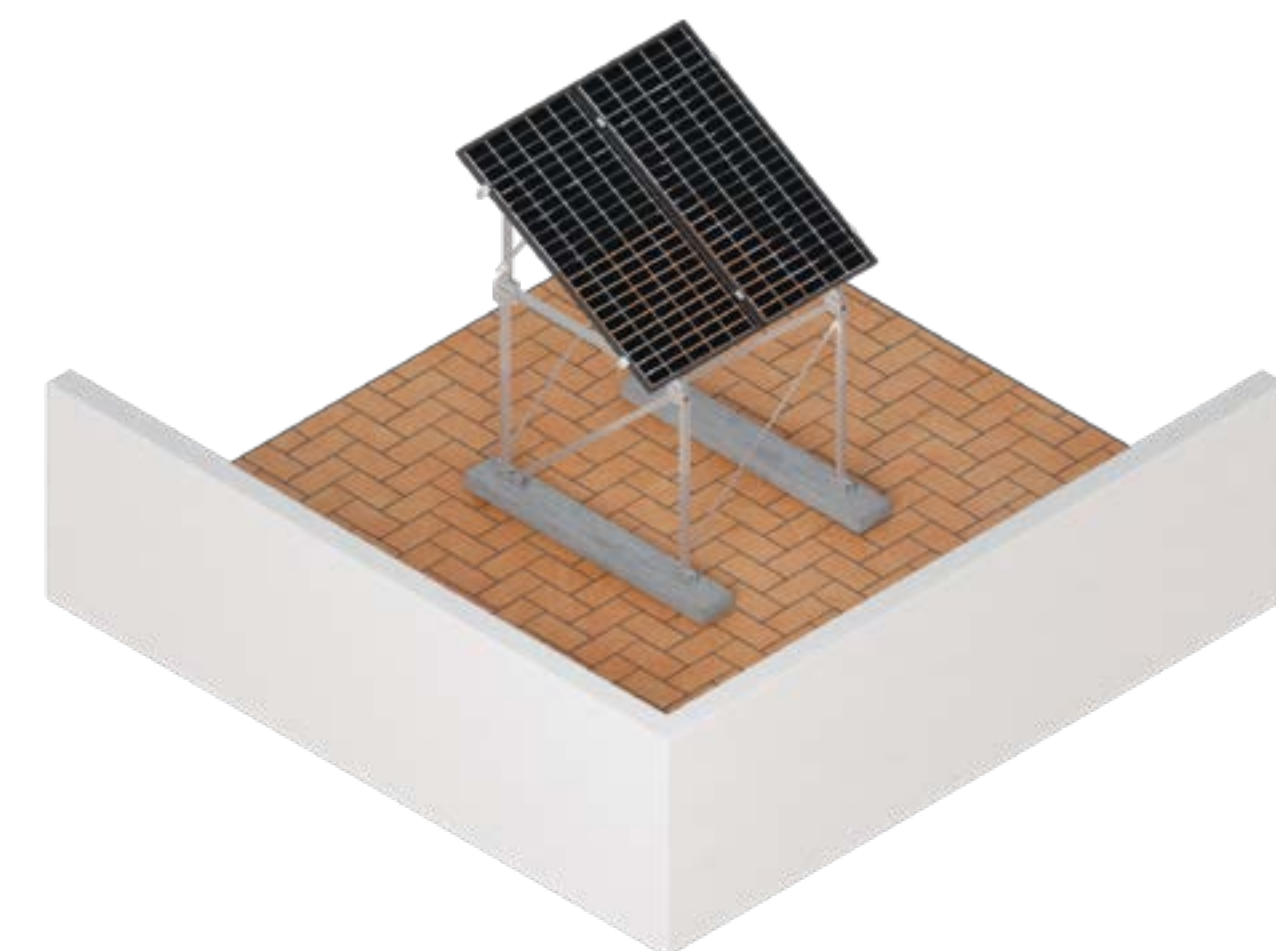

Instalación correcta de triángulo abierto sobre contrapesos de hormigón.

KITS

41V-500

41V-1000

41V-1500

COMPONENTES DEL KIT



Estructura de soporte



S36

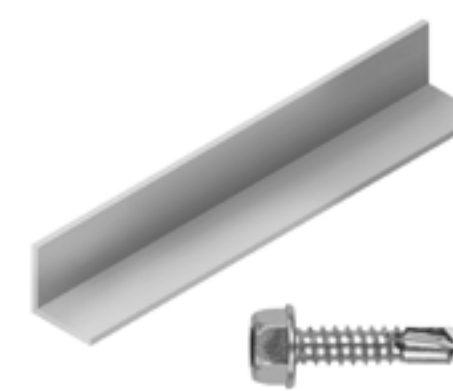

41VD
(No incluida)



41V-500



41V-1000



41V-1500



Formato Kit

[Ver Vídeo](#)

[Ver manual de montaje](#)

ESPECIFICACIONES

Superficie de instalación	Cubierta plana
Superficie de anclaje	Anclaje a cubierta de hormigón o losa de hormigón continua
Tornillería de anclaje	Incluye tornillería de anclaje de triángulos a 41H
Altura	500 mm 1000 mm 1500 mm
Disposición del módulo	Compatible con estructuras para módulos en horizontal
Tamaño máximo del panel	Dependerá de la estructura base
Espesor del panel	28-40 mm
Perfilería	Aluminio EN AW-6005A T6 (Crudo o anodizado)
Tornillería	Acero inoxidable A2-70

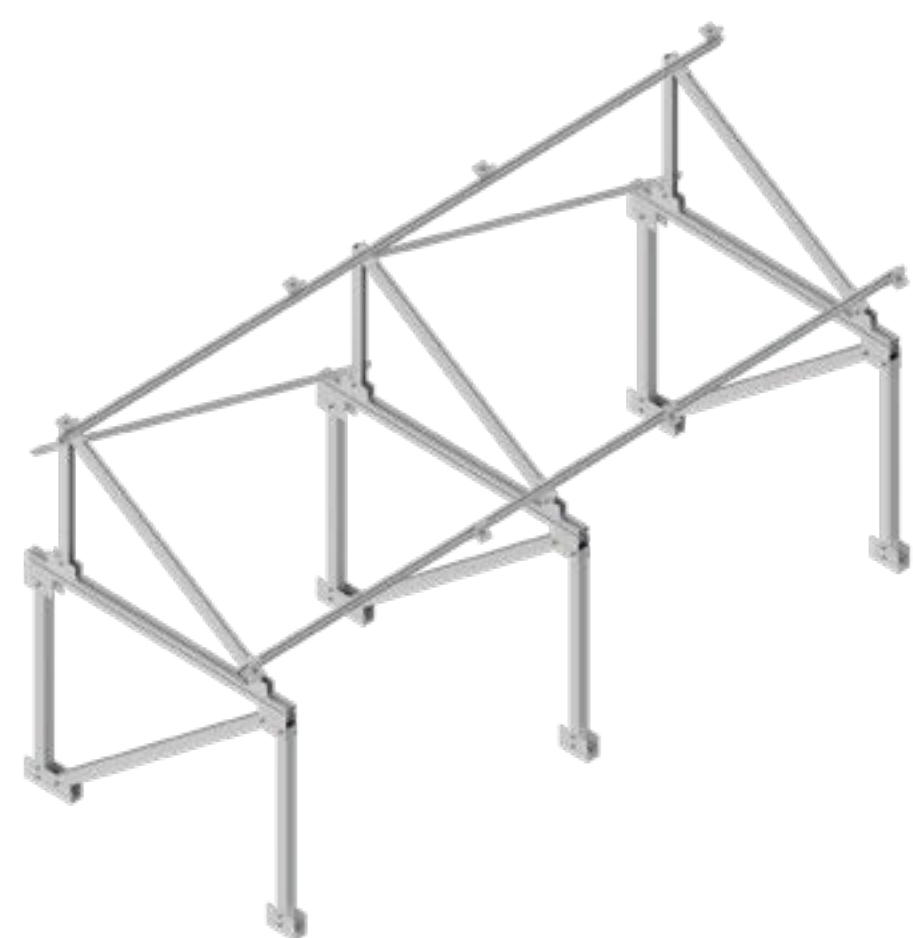

Instalación correcta de triángulo abierto sobre contrapesos de hormigón.

⚠ Información importante:

Por cada triángulo es necesario 1 Ud. de 41H.

Independientemente de los módulos y de los triángulos solo será necesario un kit de arriostramiento 41VD por cada fila o mesa.

Bordillos no incluidos.
Soporte inclinado no incluido.

KITS

41H-500

41H-1000

41H-1500

COMPONENTES DEL KIT



Estructura de soporte



S36

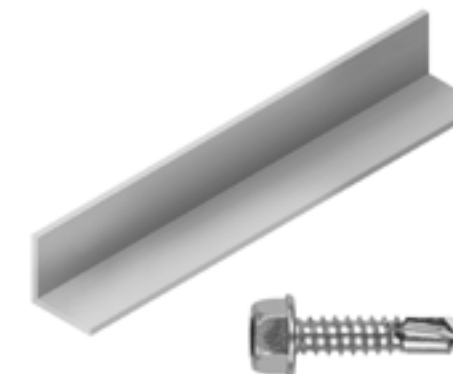

41VD
(No incluida)

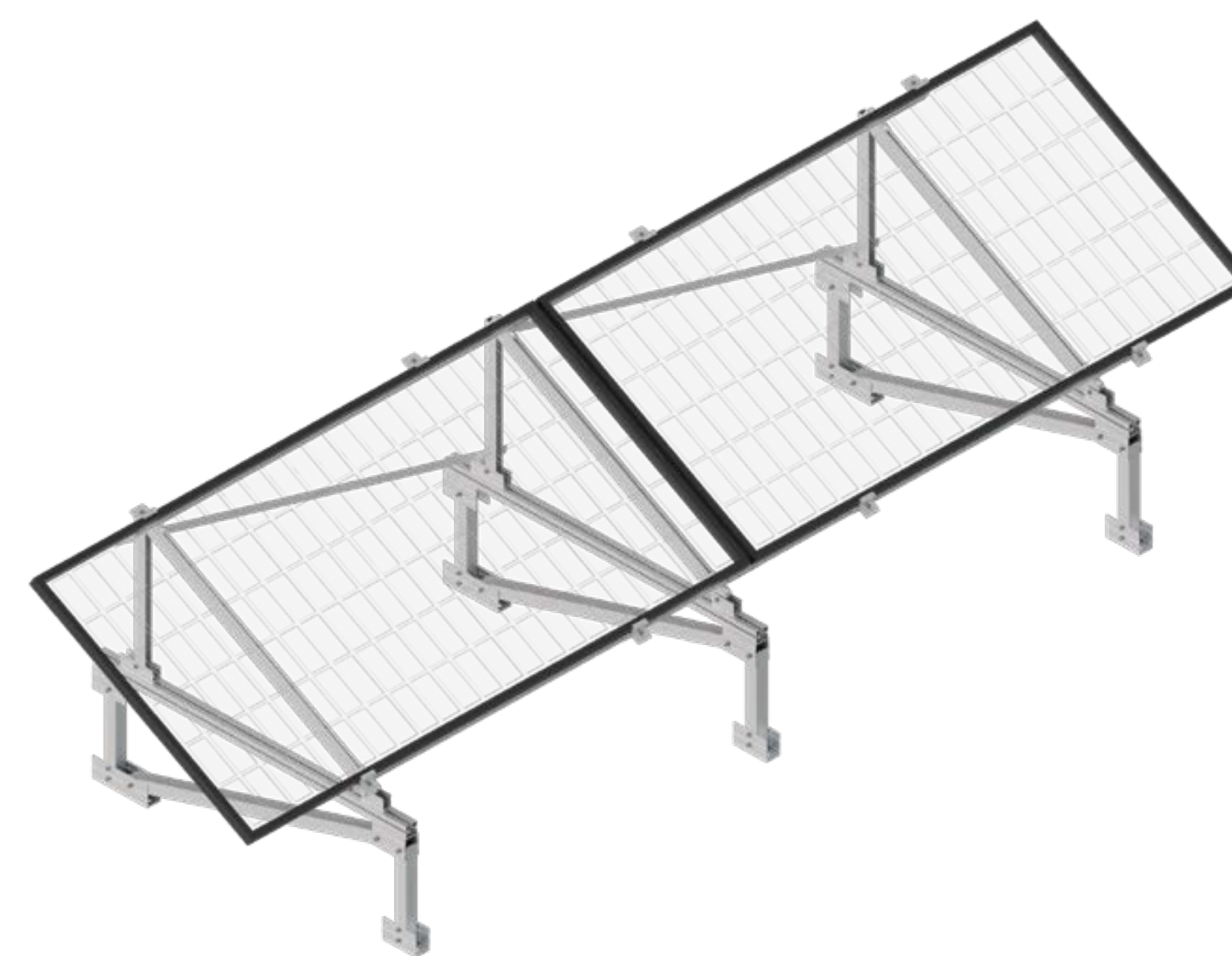

41H-500



41H-1000



41H-1500



Formato Kit

Ver manual de montaje

Formatos de venta



En Kits

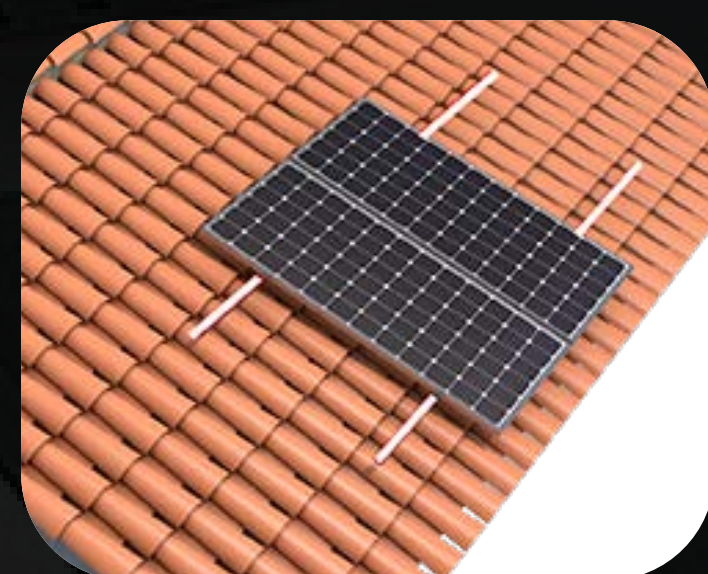

**Soportes
para cubierta
de teja**

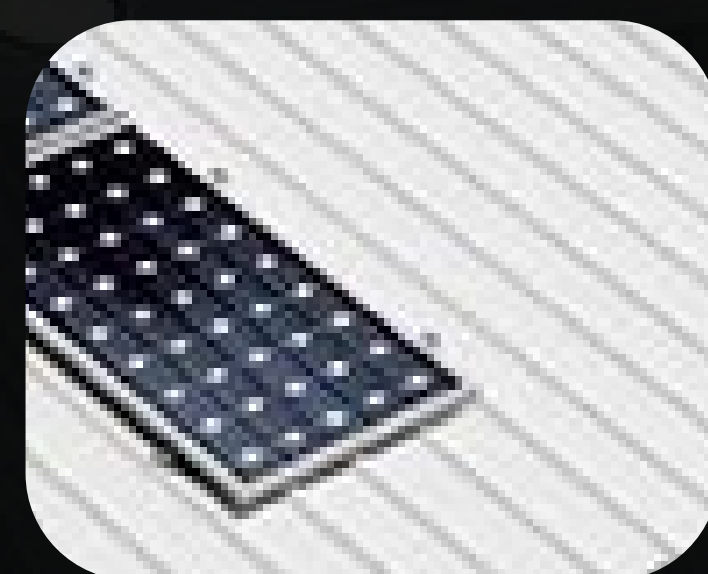

**Soportes
para cubierta
metálica**



**Inclinados
para cubierta**



Lastrados



Fachadas



**Inclinados
para terrenos**



**Marquesinas
de
aparcamiento**



**Subestructu-
ras**



Kits de unión

Soportes para cubierta de teja (Kit)

Carril continuo



Ref	Vol. (mm)	Peso (kg)
01V1	1480x140x80	3,9
01V2	1550x200x80	6,50
01V3	1950x200x80	9,00
01V4	1950x200x85	11,40
01V5	1950x200x120	15,10
01V6	1950x200x120	17,10

Transporte inferior a 2,4 metros.



Ref	Vol. (mm)	Peso (kg)
02V1	1480x140x80	4,30
02V2	1550x200x80	6,80
02V3	1950x200x80	9,60
02V4	1950x200x85	11,90
02V5	1950x200x120	15,80
02V6	1950x200x120	18,00

Transporte inferior a 2,4 metros.

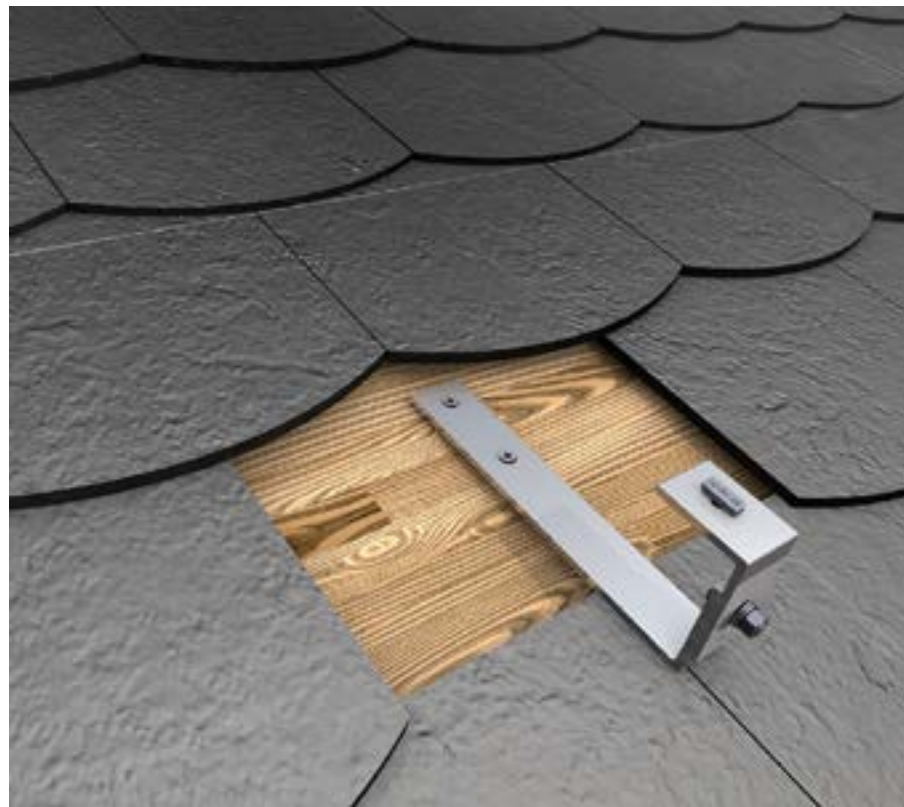

Ref	Vol. (mm)	Peso (kg)
02.1V1	1480x140x80	4,30
02.1V2	1550x200x80	6,80
02.1V3	1950x200x80	9,60
02.1V4	1950x200x85	12,00
02.1V5	1950x200x120	15,80
02.1V6	1950x200x120	18,00

Transporte inferior a 2,4 metros.



Ref	Vol. (mm)	Peso (kg)
02.2V1	1550x200x80	7,50
02.2V2	1550x200x80	9,80
02.2V3	1950x200x120	14,30
02.2V4	1950x200x120	16,70
02.2V5	1950x200x220	21,70
02.2V6	1950x200x220	25,40

Transporte inferior a 2,4 metros.



Ref	Vol. (mm)	Peso (kg)
02.3V1	1480x140x80	4,50
02.3V2	1550x200x80	7,00
02.3V3	1950x200x85	9,90
02.3V4	1950x200x85	12,30
02.3V5	1950x200x120	16,00
02.3V6	1950x200x120	18,30

Transporte inferior a 2,4 metros.

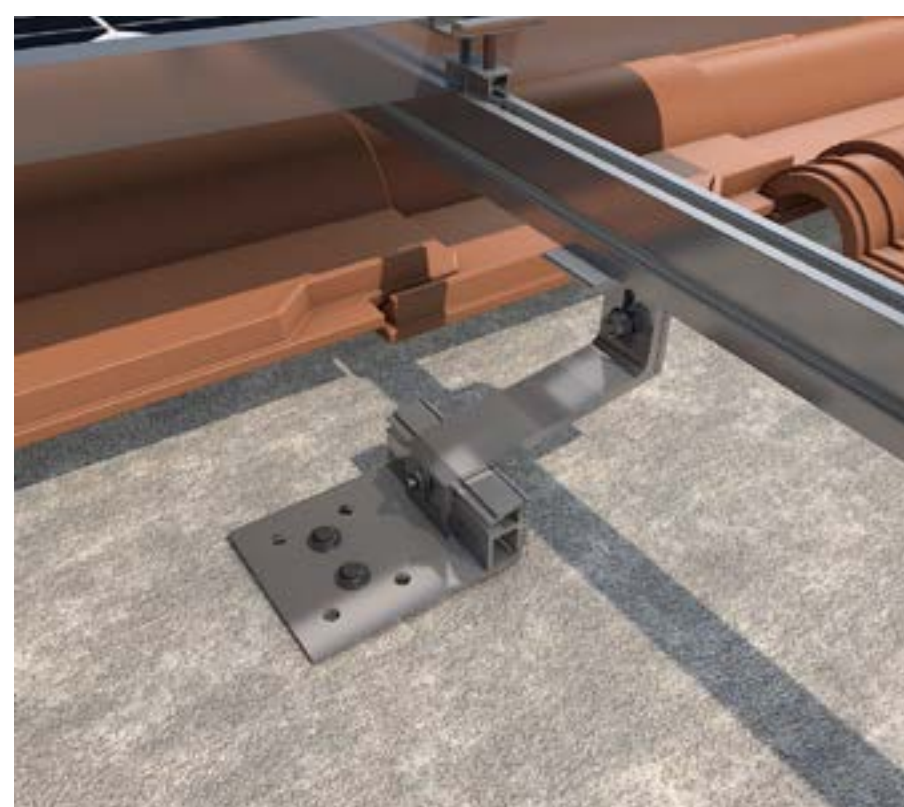

Ref	Vol. (mm)	Peso (kg)
02.4V1	1480x140x80	4,30
02.4V2	1950x200x80	6,80
02.4V3	1950x200x85	9,60
02.4V4	1950x200x120	11,90
02.4V5	1950x200x120	15,80
02.4V6	1950x200x120	18,00

Transporte inferior a 2,4 metros.

Soportes para cubierta metálica (Kit)

Carril continuo

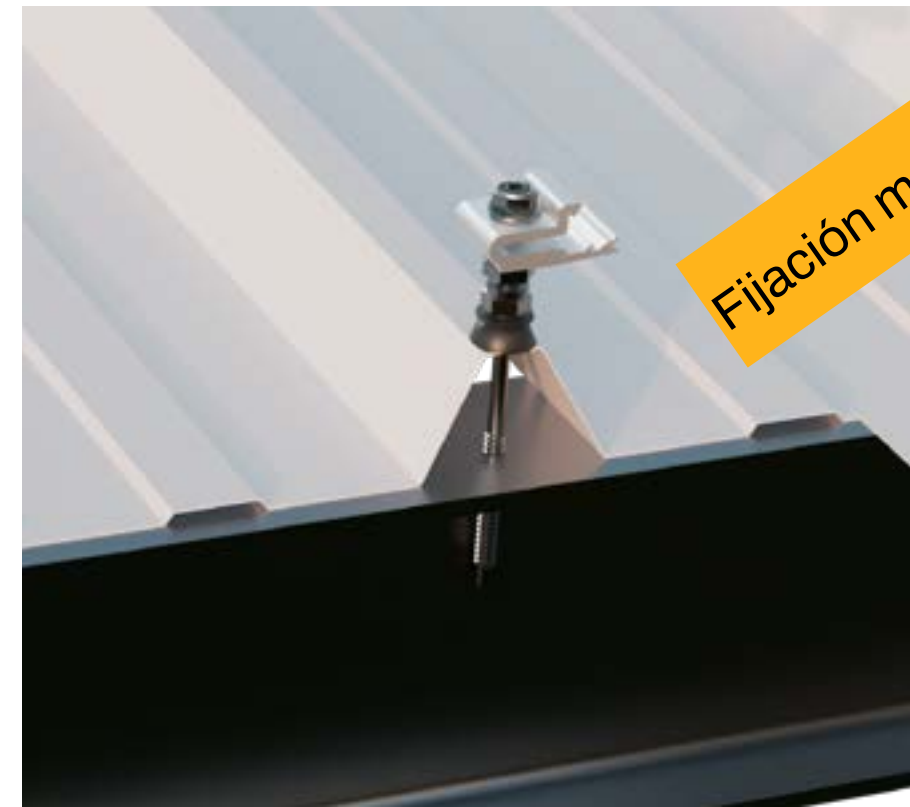

	Vol. (mm)	Peso (kg)
01.1V1	1480x140x80	3,60
01.1V2	1550x200x80	6,20
01.1V3	1950x200x80	8,60
01.1V4	1950x200x85	11,00
01.1V5	1950x200x120	14,30
01.1V6	1950x200x120	16,20

Transporte inferior a 2,4 metros.

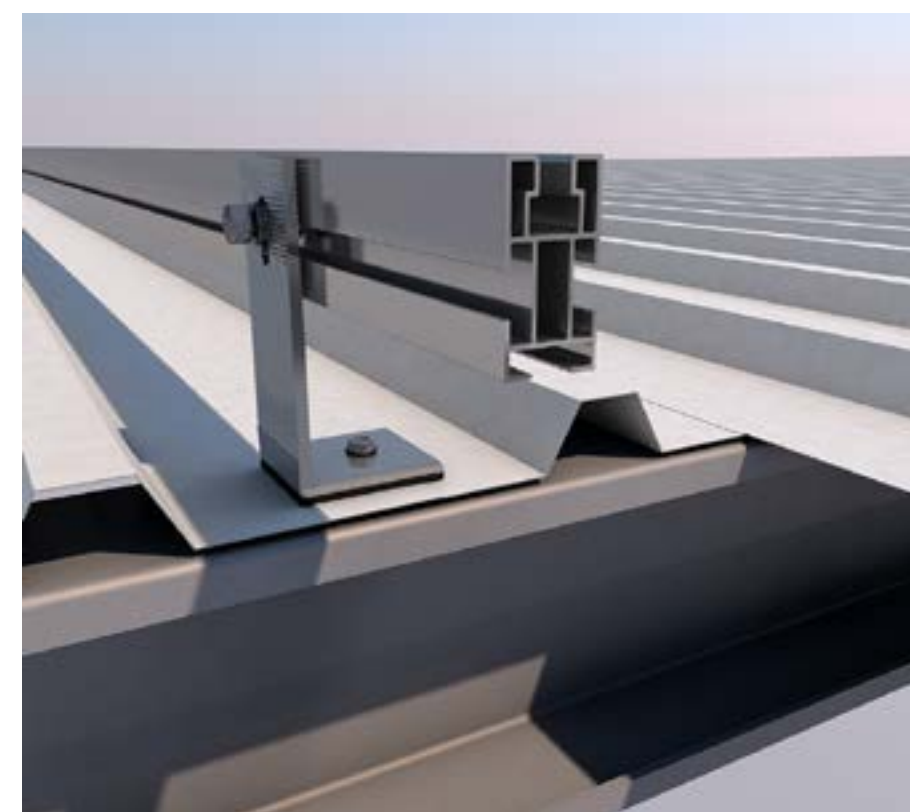

Ref	Vol. (mm)	Peso (kg)
03V1	1480x140x80	3,60
03V2	1550x200x80	6,10
03V3	1950x200x80	8,60
03V4	1950x200x85	10,90
03V5	1950x200x120	14,20
03V6	1950x200x120	16,10

Transporte inferior a 2,4 metros.

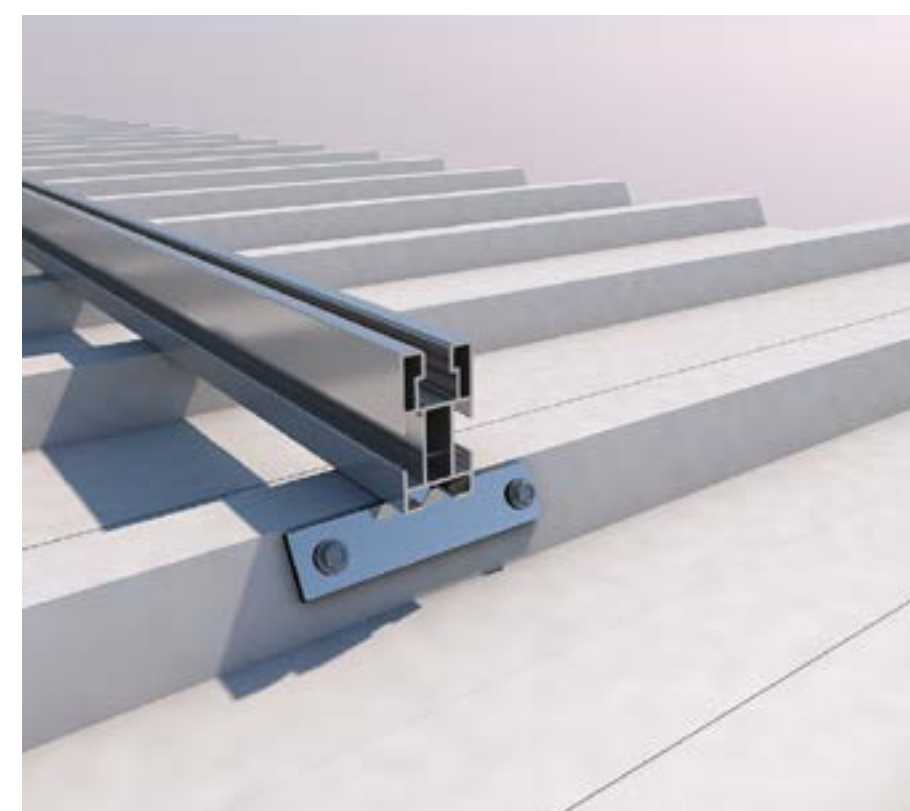

Ref	Vol. (mm)	Peso (kg)
04V1	1480x140x80	3,20
04V2	1550x200x80	5,80
04V3	1950x200x80	8,10
04V4	1950x200x85	10,60
04V5	1950x200x120	13,80
04V6	1950x200x120	15,40

Transporte inferior a 2,4 metros.

Micro-rail



Ref	Vol. (mm)	Peso (kg)
05V1	600x200x80	1,74
05V2	600x200x80	2,38
05V3	600x200x80	3,02
05V4	600x200x80	3,67
05V5	600x200x160	4,41
05V6	600x200x160	5,05
05V7	600x200x160	5,69
05V8	600x200x160	6,33

Transporte inferior a 2,4 metros.



Ref	Vol. (mm)	Peso (kg)
07H1	400x200x120	1,59
07H2	400x200x120	2,23
07H3	400x200x250	2,88
07H4	400x200x250	3,52
07H5	400x200x250	4,17
07H6	400x200x250	4,82
07H7	400x200x250	5,46
07H8	400x200x250	6,11

Transporte inferior a 2,4 metros.



Formato Kit



Soportes para cubierta metálica (Kit)

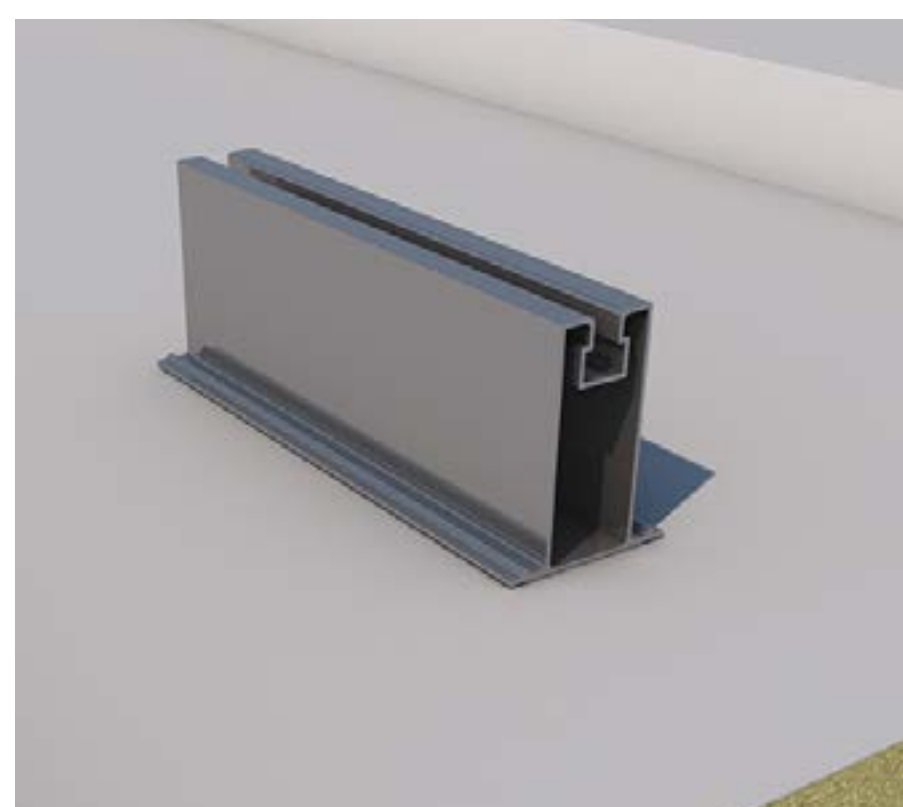

Ref	Vol. (mm)	Peso (kg)
07.1H1	400x200x120	1,59
07.1H2	400x200x120	2,23
07.1H3	400x200x250	2,88
07.1H4	400x200x250	3,52
07.1H5	400x200x250	4,17
07.1H6	400x200x250	4,82
07.1H7	400x200x250	5,46
07.1H8	400x200x250	6,11

Transporte inferior a 2,4 metros.

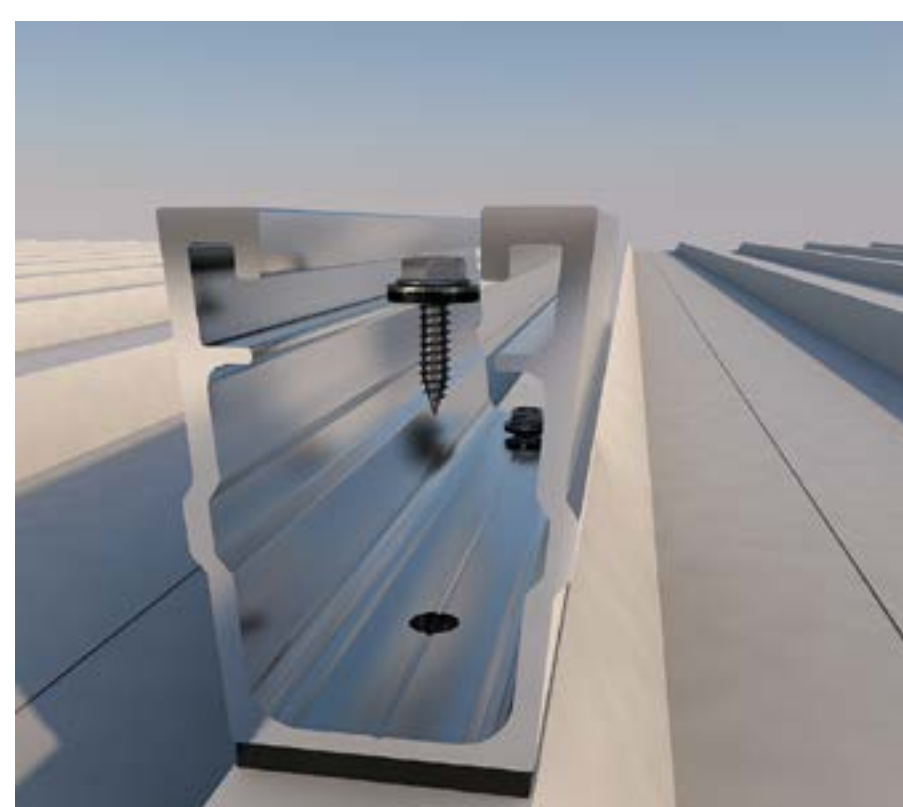

Ref	Vol. (mm)	Peso (kg)
61H1	400x200x80	1,22
61H2	400x200x80	1,67
61H3	400x200x80	2,12
61H4	400x200x80	2,56
61H5	400x200x80	3,01
61H6	400x200x80	3,45
61H7	400x200x120	3,90
61H8	400x200x120	4,34

Transporte inferior a 2,4 metros.



Ref	Vol. (mm)	Peso (kg)
62V1	600x200x80	2,04
62V2	600x200x80	2,94
62V3	600x200x80	3,84
62V4	600x200x80	4,74
62V5	600x200x80	5,65
62V6	600x200x160	6,55
62V7	600x200x160	7,45
62V8	600x200x160	8,35

Transporte inferior a 2,4 metros.



Formato Kit

Inclinados para cubierta (Kit)

Triángulo abierto



Ref	Vol. (mm)	Peso (kg)
08V1	1950x200x80	8,00
08V2	1950x200x120	10,20
08V3	1950x200x120	14,20
08V4	1950x200x220	16,40
08V5	1950x200x220	21,20
08V6	1950x200x220	24,50

Transporte inferior a 2,4 metros.



Ref	Vol. (mm)	Peso (kg)
09V1	1950x200x80	8,80
09V2	1950x200x120	11,30
09V3	1950x200x120	15,70
09V4	1950x200x220	18,10
09V5	1950x200x220	23,20
09V6	1950x200x220	27,00

Transporte inferior a 2,4 metros.



Ref	Vol. (mm)	Peso (kg)
09H1	1950x200x80	8,00
09H2	1950x200x120	14,10
09H3	1950x200x220	20,90

Transporte inferior a 2,4 metros.



Ref	Vol. (mm)	Peso (kg)
12V1	1950x200x120	9,40
12V2	1950x200x85	12,00
12V3	1950x200x220	16,60
12V4	1950x200x220	19,00
12V5	1950x200x220	24,40
12V6	1950x200x220	28,50

Transporte inferior a 2,4 metros.



Ref	Vol. (mm)	Peso (kg)
14V1	1950x200x220	13,20
14V2	1950x200x220	16,50
14V3	2390x200x220	19,80

Transporte inferior a 2,4 metros.



Ref	Vol. (mm)	Peso (kg)
14.1V1	1950x200x220	13,80
14.1V2	2390x200x220	17,20
14.1V3	2390x200x220	20,40

Transporte inferior a 2,4 metros.



Formato Kit



Inclinados para cubierta (Kit)



Ref	Vol. (mm)	Peso (kg)
-----	-----------	-----------

19H1	1550x200x80	4,90
------	-------------	------

Transporte inferior a 2,4 metros.



Ref	Vol. (mm)	Peso (kg)
-----	-----------	-----------

24H2	2500x200x120	7,30
------	--------------	------

Transporte superior a 2,4 metros.



Ref	Vol. (mm)	Peso (kg)
-----	-----------	-----------

42V2	2390x200x220	20,80
42V4	2390x200x220	25,60
42V6	2390x200x340	37,20

Transporte inferior a 2,4 metros.

Triángulo cerrado



Ref	Vol. (mm)	Peso (kg)
-----	-----------	-----------

10V1	1950x200x80	9,00
10V2	1950x200x85	11,50
10V3	1950x200x120	16,00
10V4	1950x200x220	18,50
10V5	1950x200x220	23,60
10V6	1950x200x220	27,70

Transporte inferior a 2,4 metros.



Ref	Vol. (mm)	Peso (kg)
-----	-----------	-----------

11V1	1950x200x80	10,50
11V2	1950x200x85	13,10
11V3	1950x200x120	18,30
11V4	1950x200x220	20,70
11V5	1950x200x220	26,70
11V6	1950x200x220	31,30

Transporte inferior a 2,4 metros.



Formato Kit

Inclinados Especiales (Kit)



Ref	Vol. (mm)	Peso (kg)
11H1	1950x200x80	9,10
11H2	1950x200x120	15,70
11H3	1950x200x220	23,10

Transporte inferior a 2,4 metros.



Ref	Vol. (mm)	Peso (kg)
13V1	1950x200x80	11,30
13V2	1950x200x85	13,80
13V3	1950x200x220	19,40
13V4	1950x200x220	21,80
13V5	1950x200x220	28,20
13V6	1950x200x220	33,20

Transporte inferior a 2,4 metros.



Ref	Vol. (mm)	Peso (kg)
20H1	1550x200x80	6,00

Transporte inferior a 2,4 metros.



Ref	Vol. (mm)	Peso (kg)
21H1	1950x200x85	8,80
21H2	1950x200x220	19,70
21H3	1950x200x220	27,80

Transporte inferior a 2,4 metros.



Ref	Vol. (mm)	Peso (kg)
25H2	2500x200x120	10,20

Transporte Superior a 2,4 metros



Formato Kit

Lastrados (Kit)

Simple



Ref	Vol. (mm)	Peso (kg)
29H-A	1250x170x150	6,48
29H-B	1250x120x150	3,40
C-600	710x110x70	0,18

Transporte inferior a 2,4 metros.



Ref	Vol. (mm)	Peso (kg)
29.1H-A	1500x180x150	7,10
29.1H-B	1500x180x150	7,46
C-600	710x110x70	0,18

Transporte inferior a 2,4 metros.

Doble

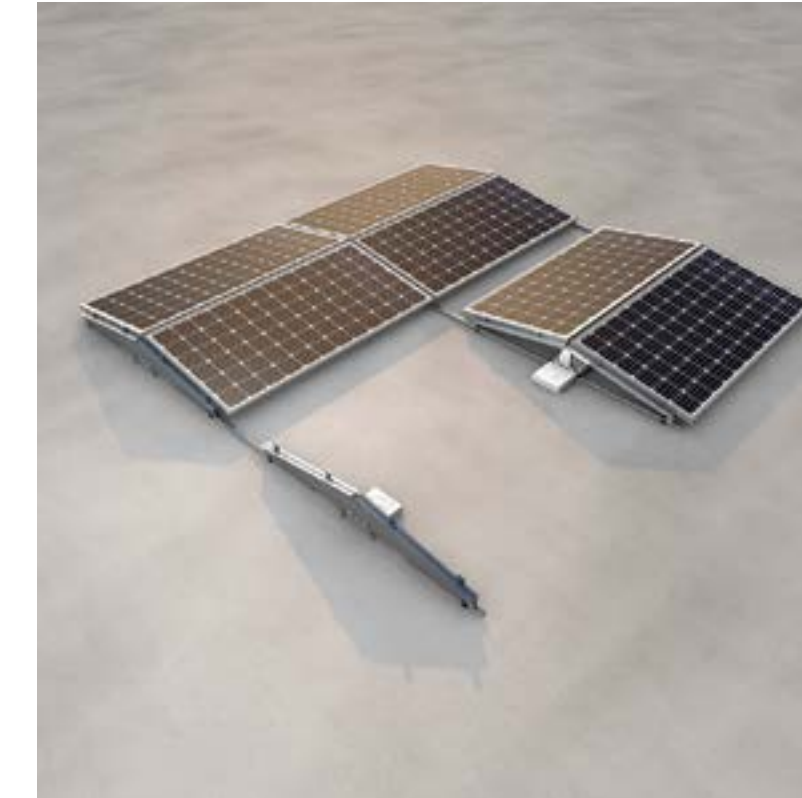

Ref	Vol. (mm)	Peso (kg)
26H-A	2200x170x150	11,49
26H-B	2200x120x150	5,55
C-600	710x110x70	0,18

Transporte inferior a 2,4 metros.



Ref	Vol. (mm)	Peso (kg)
26.1H-A	2690x170x150	12,24
26.1H-B	2690x170x150	12,60
C-600	710x110x70	0,18

Transporte superior a 2,4 metros.



Formato Kit

Pared



Ref	Vol. (mm)	Peso (kg)
15V1	1950x200x220	15,00
15V2	1950x200x220	18,40
15V3	1950x200x220	21,60

Transporte inferior a 2,4 metros.



Ref	Vol. (mm)	Peso (kg)
15H1	1950x200x220	9,80

Transporte inferior a 2,4 metros.



Ref	Vol. (mm)	Peso (kg)
16H2	2500x200x220	13,70

Transporte superior a 2,4 metros.



Formato Kit

Soportes para terrenos (Kit)

1 Fila



Ref	Vol. (mm)	Peso (kg)
40V1	2390x200x120	10,00
40V2	2390x200x120	12,30
40V3	2390x200x220	17,80
40V4	2390x200x220	20,20

Transporte inferior a 2,4 metros.



Ref	Vol. (mm)	Peso (kg)
38V8-20	Sin caja	201,00
38V-A1	Sin caja	12,00
38V-A2	Sin caja	107,00
38V-A3	Sin caja	114,00
38V-A4	Sin caja	121,00

Transporte superior a 2,4 metros.



Formato Kit

2 Filas



Ref	Vol. (mm)	Peso (kg)
31V4	Sin caja	49,00
31V6	Sin caja	54,00
31V8	Sin caja	61,00
31V10	Sin caja	81,00
31V12	Sin caja	95,00

Transporte superior a 2,4 metros.

3 Filas



Ref	Vol. (mm)	Peso (kg)
33V6	Sin caja	69,00
33V9	Sin caja	73,00
33V12	Sin caja	82,00
33V15	Sin caja	109,00
33V18	Sin caja	141,00

Transporte superior a 2,4 metros.



Ref	Vol. (mm)	Peso (kg)
35V4	Sin caja	86,00
35V6	Sin caja	91,00
35V8	Sin caja	99,00
35V10	Sin caja	136,00
35V12	Sin caja	151,00

Transporte superior a 2,4 metros.



Ref	Vol. (mm)	Peso (kg)
37V6	Sin caja	111,00
37V9	Sin caja	120,00
37V12	Sin caja	131,00
37V15	Sin caja	181,00
37V18	Sin caja	199,00

Transporte superior a 2,4 metros.

Soportes para terrenos (Kit)

Postes



Ref	Vol. (mm)	Peso (kg)
17H1	1950x200x220	14,40

Transporte inferior a 2,4 metros.

17H2	2500x200x220	18,20
------	--------------	-------

Transporte superior a 2,4 metros.



Ref	Vol. (mm)	Peso (kg)
18H1	Sin caja	35,00
18H2	Sin caja	40,00

Transporte superior a 2,4 metros.

Marquesinas de aparcamiento (Kit)

Simple

Con Chapa Normal



Ref	Peso (kg)
PR1-CC-2	732
PR1-CC-4	1207
PR1-CC-6	1664
PR1-CC-8	2121
PR1-CC-10	2578
PR1-CC-12	3035
PR1-CC-14	3492
PR1-CC-16	3949
PR1-CC-18	4406
PR1-CC-20	4863

Transporte especial.

Sin Chapa Normal



Ref	Peso (kg)
PR1-SC-2	588
PR1-SC-4	944
PR1-SC-6	1283
PR1-SC-8	1622
PR1-SC-10	1961
PR1-SC12	2300
PR1-SC-14	2639
PR1-SC-16	2978
PR1-SC-18	3317
PR1-SC-20	3656

Transporte especial.

Con Chapa Normal



Ref	Peso (kg)
PR2-CC-2	735
PR2-CC-4	1210
PR2-CC-6	1669
PR2-CC-8	2127
PR2-CC-10	2586
PR2-CC-12	3044
PR2-CC-14	3503
PR2-CC-16	3961
PR2-CC-18	4419
PR2-CC-20	4878

Transporte especial.

Sin Chapa Normal



Ref	Peso (kg)
PR2-SC-2	590
PR2-SC-4	948
PR2-SC-6	1289
PR2-SC-8	1629
PR2-SC-10	1969
PR2-SC-12	2309
PR2-SC-14	2650
PR2-SC-16	2990
PR2-SC-18	3330
PR2-SC-20	3671

Transporte especial.



Formato Kit

Marquesinas de aparcamiento (Kit)

Doble

Con Chapa Normal



Ref	Peso (kg)
PR3-CC-4	1377
PR3-CC-8	2268
PR3-CC-12	3128
PR3-CC-16	3989
PR3-CC-20	4849
PR3-CC-24	5709
PR3-CC-28	6570
PR3-CC-32	7430
PR3-CC-36	8290
PR3-CC-40	9151

Transporte especial.

Sin Chapa Normal



Ref	Peso (kg)
PR3-SC-4	1068
PR3-SC-8	1701
PR3-SC-12	2304
PR3-SC-16	2907
PR3-SC-20	3510
PR3-SC-24	4113
PR3-SC-28	4716
PR3-SC-32	5922
PR3-SC-36	5922
PR3-SC-40	6525

Transporte especial.

GP



Ref	Peso (kg)
GP-2	1.338,00
GP-3	1.528,00
GP-4	1.617,00
GP-5	1.721,00

Transporte Especial



Formato Kit

Subestructuras (Kit)

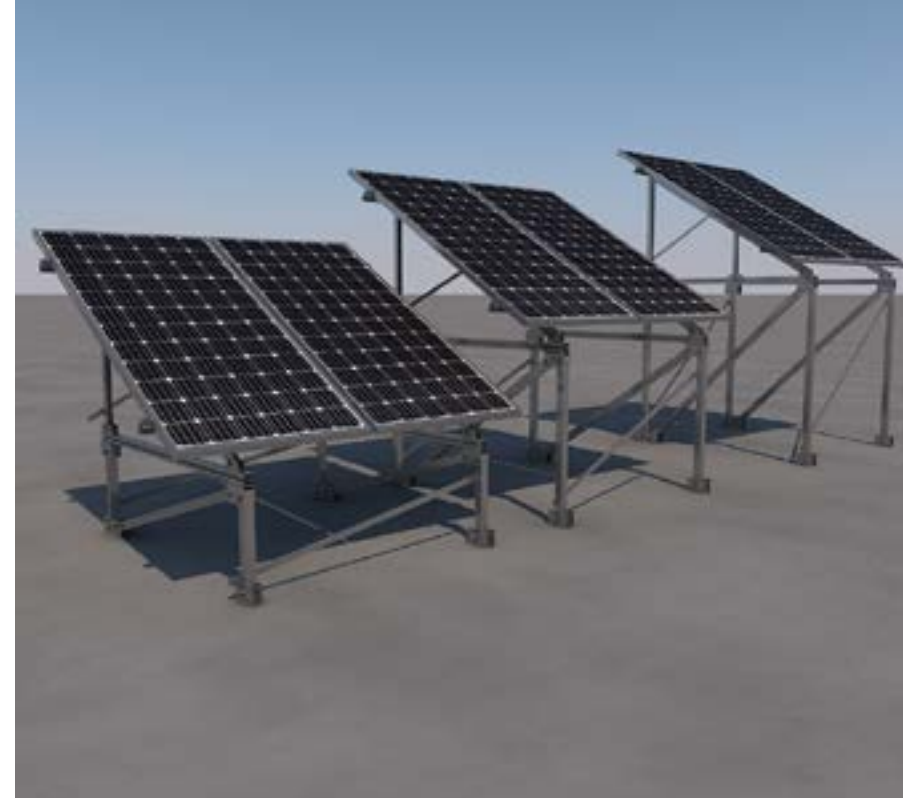

Ref	Vol. (mm)	Peso (kg)
41V-500	1950x200x120	6,50
41V-1000	1950x200x120	7,60
41V-1500	2400x150x130	8,90
41VD	Sin caja	2,80

Transporte inferior a 2,4 metros.



Ref	Vol. (mm)	Peso (kg)
41H-500	1550x200x80	5,59
41H-1000	1950x200x80	7,13
41H-1500	1950x200x120	8,53
41VD	Sin caja	2,80

Transporte inferior a 2,4 metros.



Formato Kit

Vertical



Ref. S15 – S15.2 de unión para disposición de módulos en vertical

Kit de unión para unir un Kit con otro para formar filas más largas. Válido para soportes en disposición vertical de los módulos.

Ref. S15

El kit se compone de 2 uniones UG1 + 2 presores centrales S11.

Ref. S15.2

El kit se compone de 4 uniones UG1 + 4 presores centrales S11.

Ref	Unidades	Vol. (mm)	Peso (kg)
S15	1	175x100x60	0,80
S15.2	1	280x105x65	1,60

S15

S15.2

Kits compatibles con S15	01V	01.1V	02V	02.1V	02.2V	02.3V	02.4V
	03V	04V	08V	09V	10V	11V	12V
	13V	40V					

Kits compatibles con S15.2

42V



Formato Kit

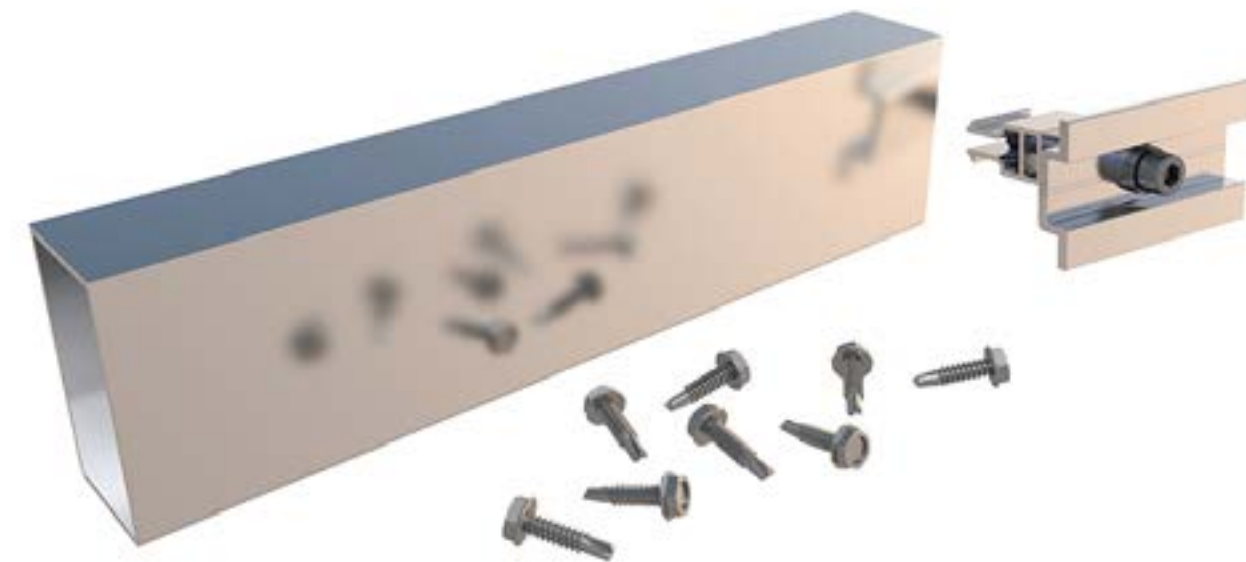

Ref. S17-S17.2-S17.3 Kit de unión para disposición de módulos en vertical

Kit de unión para unir un Kit con otro para formar filas más largas. Válido para soportes en disposición vertical de los módulos.

Ref	Unidades	Vol. (mm)	Peso (kg)
S17	1	280x105x65	1,30
S17.2	1	420x105x65	2,40
S17.3	1	400x200x80	3,60

S17

S17.2

S17.3

Ref. S17

El kit se compone de 2 uniones UG2/UG4 + 2 presores centrales S11.

Ref. S17.2

El kit se compone de 4 uniones UG2/UG4 + 4 presores centrales S11.

Ref. S17.3

El kit se compone de 6 uniones UG2/UG4 + 6 presores centrales S11.

Kits compatibles con S17

14V

14.1

15V

Kits compatibles con S17.2

31V

35V

Kits compatibles con S17.3

33V

37V



Horizontal

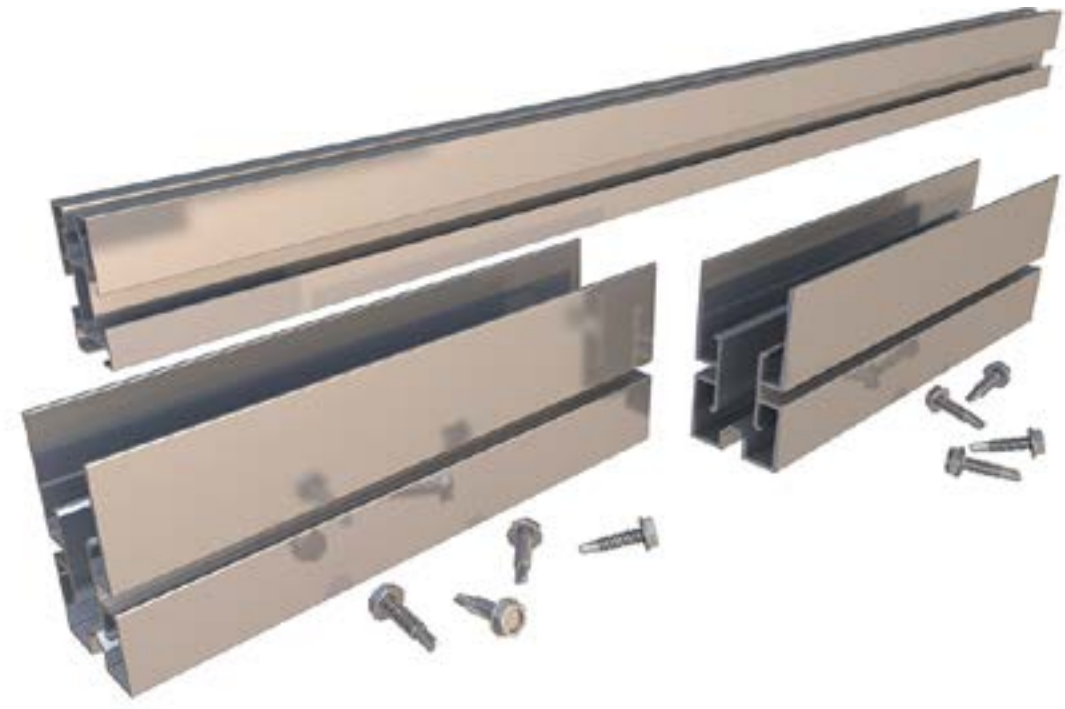

Ref. S16 Kit de unión para disposición de módulos en horizontal

Kit de unión para unir un Kit con otro para formar filas más largas. Válido para soportes en disposición horizontal de los módulos.

Ref. S16

El kit se compone de 4 uniones UG1 + 2 perfiles G1-1050 mm.

Ref	Unidades	Vol. (mm)	Peso (kg)
S16	1	1480x140x80	2,20

S16

Kits compatibles con S16

09H

11H



Formato Kit

En Bulk



Fijaciones para cubierta de teja



Fijaciones para cubierta metálica



Triángulos para cubierta



Triángulos para terreno



Triángulos para fachada



Subestructura



Arriostamientos



Uniones



Tornillería



Lastrados



Marquesinas aparcamiento



Perfilería



Presores

Fijaciones para cubierta de teja (Bulk)

Carril continuo



Ref	Unidades	Vol. (mm)	Peso (kg)
S01	2	280x105x65	0,50
	25	400x200x80	5,10



Ref	Unidades	Vol. (mm)	Peso (kg)
S01.300	2	420x105x65	0,70
	25	400x200x80	8,10



Ref	Unidades	Vol. (mm)	Peso (kg)
S01G.250	2	280x105x65	0,28
	25	400x200x80	7,00



Ref	Unidades	Vol. (mm)	Peso (kg)
S01G.300	2	280x105x65	0,70
	25	400x200x80	8,10



Ref	Unidades	Vol. (mm)	Peso (kg)
S01B	2	175x100x60	0,29
	25	420x105x65	2,05



Ref	Unidades	Vol. (mm)	Peso (kg)
S01C	2	280x105x65	0,60
	20	400x200x250	5,60



Ref	Unidades	Vol. (mm)	Peso (kg)
S02	2	280x105x65	0,60
	20	400x200x250	5,60



Ref	Unidades	Vol. (mm)	Peso (kg)
S02.1	2	280x105x65	0,60
	20	400x200x250	6,40



Ref	Unidades	Vol. (mm)	Peso (kg)
S02.2	2	400x200x80	2,10
	10	400x200x250	10,20



Ref	Unidades	Vol. (mm)	Peso (kg)
S02.3	2	400x200x80	0,70
	20	400x200x250	6,40



Ref	Unidades	Vol. (mm)	Peso (kg)
S02.4	2	400x200x80	1,31
	10	400x200x250	5,80



Formato Bulk

Fijaciones para cubierta metálica (Bulk)

Carril continuo



Ref	Unidades	Vol. (mm)	Peso (kg)
S01.1	2	175x100x60	0,40
	25	400x200x80	5,00



Ref	Unidades	Vol. (mm)	Peso (kg)
S03	2	175x100x60	0,30
	25	400x200x80	3,40



Ref	Unidades	Vol. (mm)	Peso (kg)
S04	20	175x100x60	1,10
	150	400x200x120	7,50



Ref	Unidades	Vol. (mm)	Peso (kg)
S04-BI	20	175x100x60	1,10
	150	400x200x120	7,50

Micro-rail



Ref	Unidades	Vol. (mm)	Peso (kg)
S05	2	420x105x65	0,80
	25	400x200x250	7,09



Ref	Unidades	Vol. (mm)	Peso (kg)
S05-BI	2	420x105x65	0,66
	25	600x200x160	6,25



Ref	Unidades	Vol. (mm)	Peso (kg)
S05.1	2	420x105x65	1,05
	25	400x200x250	12,09



Ref	Unidades	Vol. (mm)	Peso (kg)
S07	2	400x200x80	0,70
	20	400x200x250	6,00



Ref	Unidades	Vol. (mm)	Peso (kg)
S07-BI	2	420x105x65	0,70
	20	400x200x250	6,00



Ref	Unidades	Vol. (mm)	Peso (kg)
S07.1	2	420x105x65	0,50
	20	400x200x250	4,90



Formato Bulk

Fijaciones para cubierta metálica (Bulk)



Ref	Unidades	Vol. (mm)	Peso (kg)
S40	2	175x100x60	0,60
	25	400x200x120	7,30



Ref	Unidades	Vol. (mm)	Peso (kg)
S41	2	280x105x65	1,00
	25	400x200x250	13,37



Ref	Unidades	Vol. (mm)	Peso (kg)
S61	2	175x100x60	0,50
	25	400x200x120	4,50

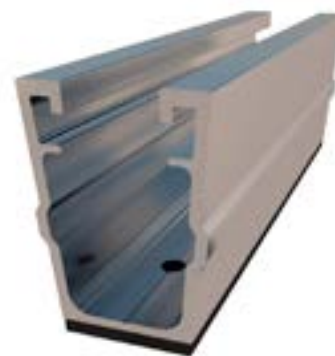

Ref	Unidades	Vol. (mm)	Peso (kg)
S61-BI	2	175x100x60	0,40
	25	400x200x120	4,76



Ref	Unidades	Vol. (mm)	Peso (kg)
S62	2	420x105x65	1,24
	25	400x200x250	9,80



Ref	Unidades	Vol. (mm)	Peso (kg)
S62-BI	2	420x105x65	1,01
	25	400x200x250	12,15



Ref	Unidades	Vol. (ml)	Peso (kg)
BI-50	1	50	0,12



Ref	Unidades	Vol. (ml)	Peso (kg)
BI-250	1	250	0,23

Triángulos para cubierta (Bulk)

Abiertos



Ref	Unidades	Vol. (mm)	Peso (kg)
TR08V	1	1480x140x80	2,40
	10	1500x420x110	19,4



Ref	Unidades	Vol. (mm)	Peso (kg)
TR09V	1	1880x120x60	3,10
	10	2000x420x110	23,60



Ref	Unidades	Vol. (mm)	Peso (kg)
TR09H	1	1480x140x80	2,30
	10	1500x420x110	16,90



Ref	Unidades	Vol. (mm)	Peso (kg)
TR12V	1	1950x200x80	3,40
	10	2000x420x110	26,40



Ref	Unidades	Vol. (mm)	Peso (kg)
TR14V	1	1950x200x80	4,40
	5	1950x400x200	19,20



Ref	Unidades	Vol. (mm)	Peso (kg)
TR14.1V	1	1950x200x80	4,70
	5	1950x400x200	20,70



Ref	Unidades	Vol. (mm)	Peso (kg)
TR19H	1	1480x140x80	2,14
	10	1500x420x110	15,2



Ref	Unidades	Vol. (mm)	Peso (kg)
TR42V	1	2390x200x120	7,94
	5	2390x200x340	36,70

Cerrados



Ref	Unidades	Vol. (mm)	Peso (kg)
TR10V	1	1480x140x80	2,70
	10	1500x420x110	22,40



Ref	Unidades	Vol. (mm)	Peso (kg)
TR11V	1	1880x120x60	3,94
	10	2000x420x110	32,3



Ref	Unidades	Vol. (mm)	Peso (kg)
TR11H	1	1480x140x80	2,9
	10	1500x420x110	22,4



Ref	Unidades	Vol. (mm)	Peso (kg)
TR13V	1	1950x200x80	4,30
	10	2000x420x110	35,70



Ref	Unidades	Vol. (mm)	Peso (kg)
TR20H	1	1480x140x80	2,75
	10	280x105x65	20,70



Formato Bulk

Cubierta plana



Ref	Unidades	Vol. (mm)	Peso (kg)
41V-500	1	1950x200x120	8,11
41V-1000	1	1950x200x120	9,06
41V-1500	1	2400x150x130	9,70



Ref	Unidades	Vol. (mm)	Peso (kg)
41H-500	1	1550x200x80	6,45
41H-1000	1	1950x200x80	7,74
41H-1500	1	1950x200x120	9,17

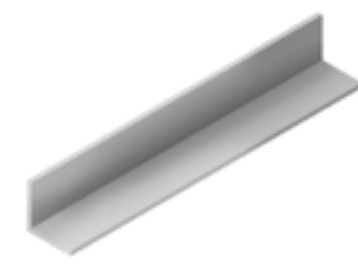

Ref	Unidades	Vol. (mm)	Peso (kg)
41VD	1	Sin caja	3,93

Cubierta metálica

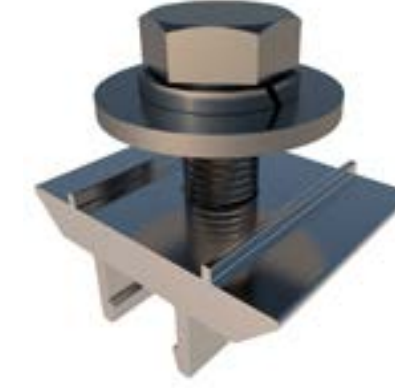

Ref	Unidades	Vol. (mm)	Peso (kg)
S35	10	175x100x60	0,4
	50	280x105x65	2,00



Ref	Unidades	Vol. (mm)	Peso (kg)
S36	10	175x100x60	0,30
	100	280x105x65	2,60



Ref	Unidades	Vol. (mm)	Peso (kg)
S37	2	420x105x65	0,80
	20	400x200x250	7,60



Ref	Unidades	Vol. (mm)	Peso (kg)
S38	2	710x110x75	1,00
	20	1480x140x80	9,60



Formato Bulk

Triángulos para terreno (Bulk)

Fila 1



Ref	Unidades	Vol. (mm)	Peso (kg)
TR40V	1	1950x200x80	3,80
	5	2000x420x110	16,30

Fila 2



Ref	Unidades	Vol. (mm)	Peso (kg)
TR31V	1	Sin caja > 2400	14,00
	10	Sin caja > 2400	145,70



Ref	Unidades	Vol. (mm)	Peso (kg)
TR35V	1	Sin caja > 2400	13,10
	10	Sin caja > 2400	136,20

Fila 3



Ref	Unidades	Vol. (mm)	Peso (kg)
TR33V	1	Sin caja > 2400	22,80
	10	Sin caja > 2400	233,10



Ref	Unidades	Vol. (mm)	Peso (kg)
TR37V	1	Sin caja > 2400	22,20
	10	Sin caja > 2400	227,60

Hincas

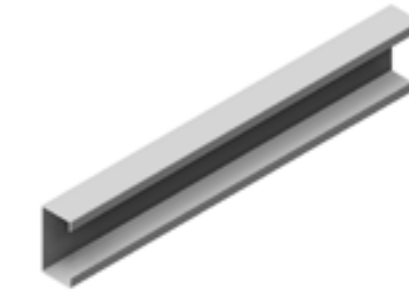

Ref	Unidades	Vol. (mm)	Peso (kg)
Hinca	1	Sin caja > 2400	20,00



Formato Bulk

Arriostramientos (Bulk)

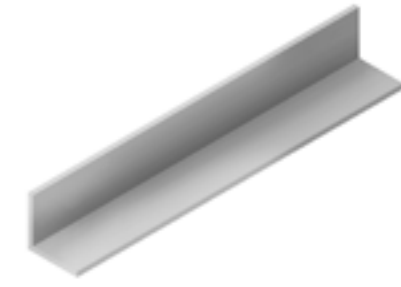

Ref	Unidades	Vol. (mm)	Peso (kg)
S08-1600	1	Sin caja < 2400	0,40
	10	Sin caja < 2400	4,00
S08-1900	1	Sin caja < 2400	0,50
	10	Sin caja < 2400	5,00
S08-2200	1	Sin caja < 2400	0,60
	10	Sin caja < 2400	6,00
S08-2400	1	Sin caja > 2400	0,70
	10	Sin caja > 2400	7,00
S08-2600	1	Sin caja > 2400	0,80
	10	Sin caja > 2400	8,00

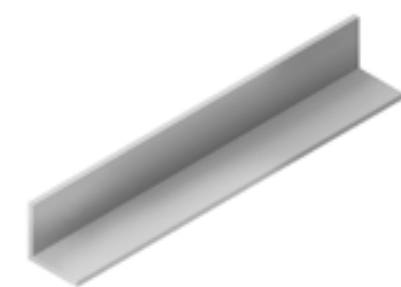

Ref	Unidades	Vol. (mm)	Peso (kg)
S09-3000	2	Sin caja > 2400	2,90
	10	Sin caja > 2400	14,50
S09-3500	2	Sin caja > 2400	3,30
	10	Sin caja > 2400	16,40
S09-4000	2	Sin caja > 2400	3,80
	10	Sin caja > 2400	18,70



Formato Bulk

Triángulos para fachada (Bulk)

Pared



Ref	Unidades	Vol. (mm)	Peso (kg)
TR15V	1	1950x200x80	6,30
	5	1950x400x200	28,60



Formato Bulk

Accesorios Lastrados (Bulk)

Simple

Ref	Unidades	Vol. (mm)	Peso (kg)
 TR29H	1	1485x143x77	1,98
	10	1325x550x145	21,80
 A29H	1	710x110x75	1,97
	5	980x290x135	6,24
 B29H	5	980x290x135	3,96
	10	1325x290x135	7,92

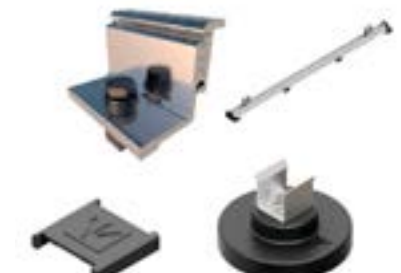
Ref	Unidades	Vol. (mm)	Peso (kg)
 TR29.1H	2	1550x200x80	3,99
	10	1500x405x145	26,40
 A29.1H	1	680x185x90	2,74
	5	980x290x135	9,12
 B29.1H	1	1480x140x80	3,04
	5	1325x290x135	10,92

Doble

Ref	Unidades	Vol. (mm)	Peso (kg)
 TR26H	1	2400x150x130	3,47
	10	2200x550x145	47,04
 A26H	1	710x110x75	1,90
	5	1325x290x135	8,40
 B26H	5	710x110x75	4,25
	10	980x290x135	8,51

Ref	Unidades	Vol. (mm)	Peso (kg)
 TR26.1H	2	2690x170x150	7,05
	10	2690x405x145	49,92
 A26.1H	1	680x185x90	3,10
	5	1325x290x135	11,28
 B26.1H	1	680x185x90	11,20
	5	1325x290x135	13,08



Formato Bulk



Accesorios Lastrados (Bulk)

Tapas



Ref	Unidades	Vol. (mm)	Peso (kg)
WLG-10	1	Sin caja	0,64
WLG-15	1	Sin caja	0,80



Ref	Unidades	Vol. (mm)	Peso (kg)
WG-1800-10	1	Sin caja	1,49
WG-2279-10	1	Sin caja	1,80
WG-2400-10	1	Sin caja	2,70
WG-1800-15	1	Sin caja	2,24
WG-2279-15	1	Sin caja	2,90
WG-2400-15	1	Sin caja	3,05

Uniones



Ref	Unidades	Vol. (mm)	Peso (kg)
C-600	1	710x110x70	0,18
	10	680x185x90	3,68



Formato Bulk

Marquesinas de aparcamiento

(Bulk)

PR



Ref	Unidades	Vol. (mm)	Peso (kg)
P-PR1	1	Sin caja	170,00



Ref	Unidades	Vol. (mm)	Peso (kg)
P-PR2	1	Sin caja	175,00



Ref	Unidades	Vol. (mm)	Peso (kg)
P-PR3	1	Sin caja	350,00



Ref	Unidades	Vol. (mm)	Peso (kg)
C-4995	1	Sin caja	20,00



Ref	Unidades	Vol. (mm)	Peso (kg)
C-6167	1	Sin caja	25,00



Ref	Unidades	Vol. (mm)	Peso (kg)
C-4284	1	Sin caja	17,56



Ref	Unidades	Vol. (mm)	Peso (kg)
C-3084	1	Sin caja	12,65



Ref	Unidades	Vol. (mm)	Peso (kg)
Chapa 0,5 mm	1	Sin caja	21,40



Ref	Unidades	Vol. (mm)	Peso (kg)
Chapa 0,63 mm	1	Sin caja	28,94



Ref	Unidades	Vol. (mm)	Peso (kg)
Chapa 0,63 mm antigoteo	1	Sin caja	28,94



Ref	Unidades	Vol. (mm)	Peso (kg)
S81	1	Sin caja	0,12



Formato Bulk

Perfiles



Ref	Unidades	Vol. (mm)	Peso (kg)
G1-1230	1	1230x26x50	1,00
	96	1230x500x500	104,60
G1-2200	1	2200x26x50	1,80
	96	2200x 500x500	179,00
G1-2350	1	2350x26x50	2,00
	96	2350x500x500	190,00
G1-2400	1	2400x26x50	1,96
	96	2400x500x500	191,50
G1-3600	1	3600x26x50	3,00
	96	3600x500x500	289,00
G1-4400	1	4400x26x50	3,60
	96	4400x500x500	351,00
G1-4800	1	4800x26x50	4,00
	96	4800x500x500	383,00

¡Novedad G1! También disponible en lacado negro

Accesorios compatibles con perfil G1

S10	S11	S12	UG1	S36	TG1	BB-Clip	BB-Tool
Clip	TR08V	TR09V	TR09H	TR10V	TR11V	TR11H	TR12V
TR13V	TR40V	TR42V					

Kits compatibles con perfil G1

01V	02V	02.1V	02.2V	02.3V	02.4V	01.1V	03V	04V
08V	09V	09H	10V	11V	11H	12V	13V	40V
42V								

Unión compatible con perfil G1

UG1

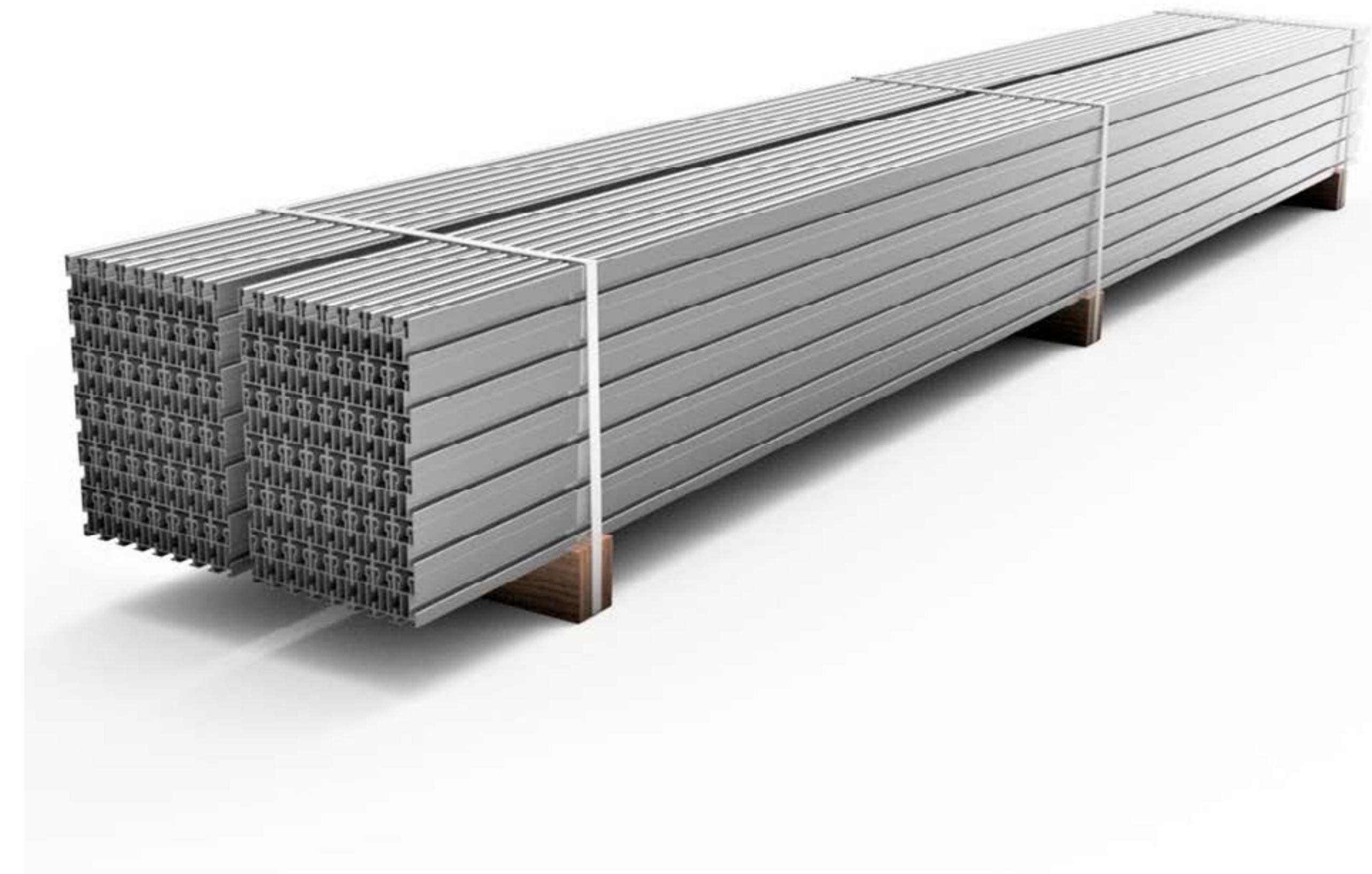

G1
Perfil para guía de módulos.



Formato Bulk



Perfiles (Bulk)

Perfiles



Ref	Unidades	Vol. (mm)	Peso (kg)
G2-2350	1	2350x26x50	2,60
	48	2350x500x500	129,40
G2-4800	1	4800x26x50	5,20
	48	4800x500x500	252,80

Accesorios compatibles con perfil G2	S10	S11	UG2/UG4	S36	Clip	TR14V	TR15V
	TR31V	TR33V	TR35V	TR37V	BB-Clip	BB-Tool	

Kits compatibles con perfil G2	14V	14.1V	15V	31V	32V	33V	34V
	35V	36V	37V				

Unión compatible con perfil G2	UG2/UG4
--------------------------------	---------

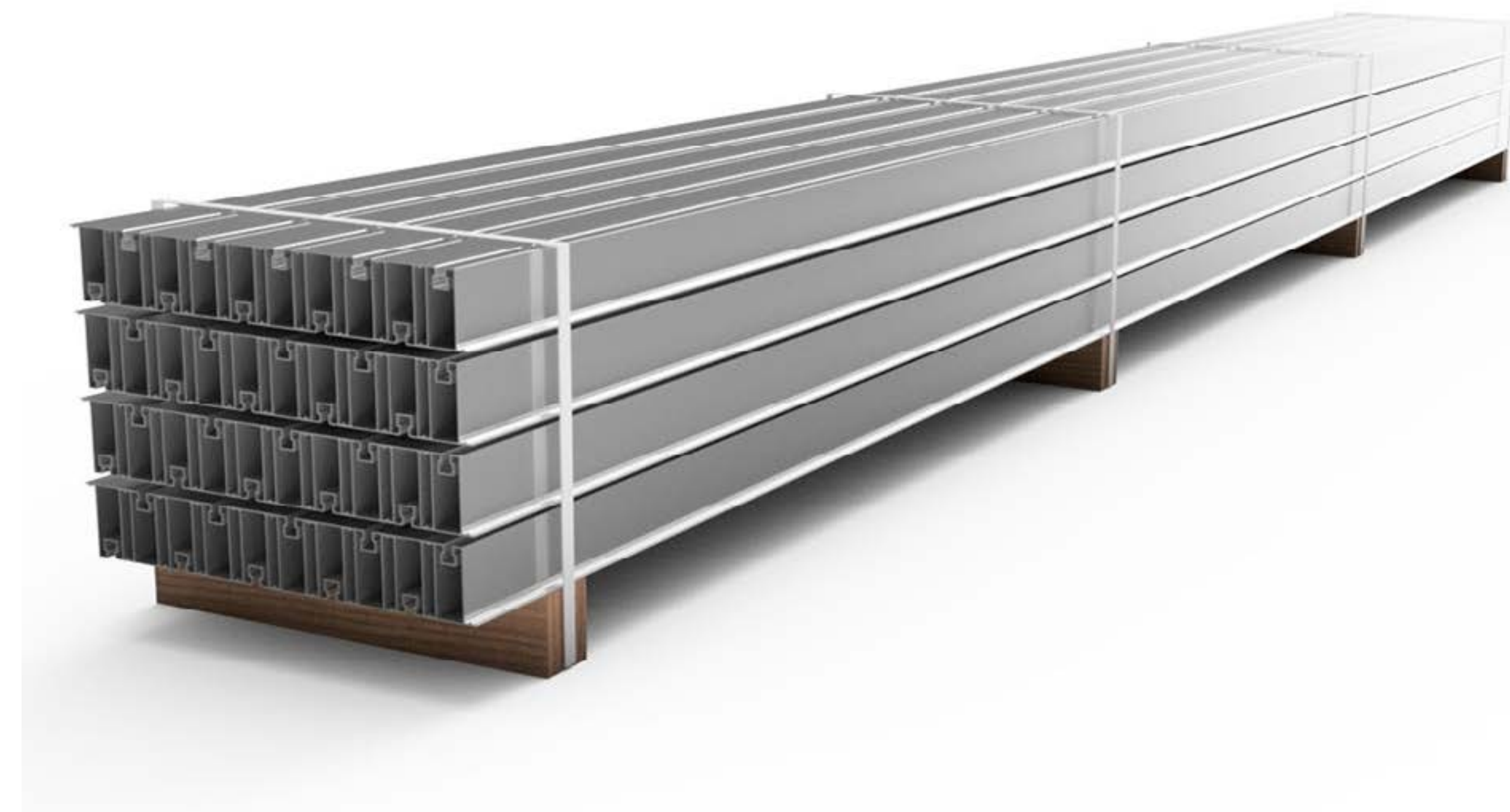

G1
Perfil para guía de módulos.



Formato Bulk



Perfiles

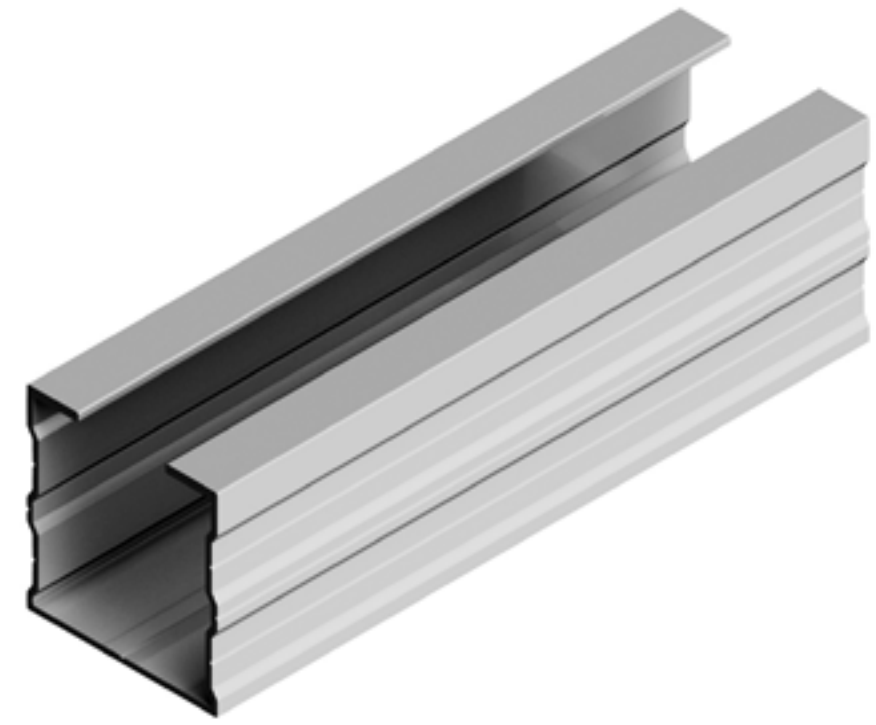

Ref	Unidades	Vol. (mm)	Peso (kg)
G3-2350	1	2350x26x50	1,60
	96	2350x500x500	152,90
G3-4800	1	4800x44x45	3,20
	96	4800x505x375	305,52

Kits compatibles con Perfil G3

08V	09V	10V	11V	19H	20H	21H	PR1
PR2	PR3	PR4					

Accesorios compatibles con Perfil G3

S10.1	S11.1	S35	S46	S42.1	BB-Clip	BB-Tool
-------	-------	-----	-----	-------	---------	---------

Unión compatible con perfil G3

UG3

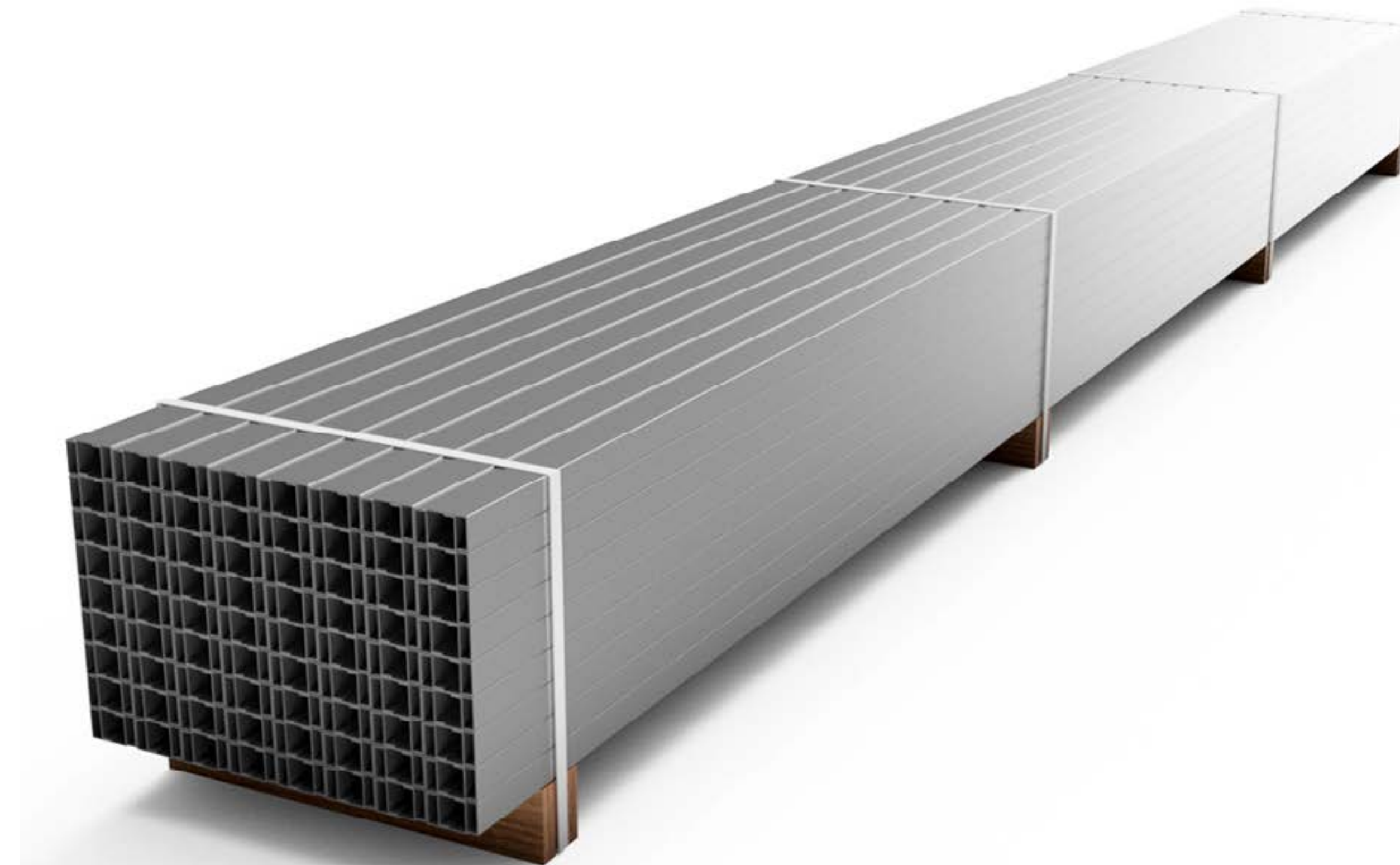

G3
Perfil para instalaciones coplanares en cubiertas metálicas y para subestructuras en cubiertas metálicas.



Formato Bulk



Perfiles



Ref	Unidades	Vol. (mm)	Peso (kg)
G4-2350	1	2350x26x50	3,00
	48	2350x500x500	146,80
G4-4800	1	4800x26x29	6,00
	48	4800x500x500	291,30

Accesorios compatibles con Perfil G4

S10	S11	UG2/UG4	S36	S46	S42.1	37V	Clip
BB-Clip	BB-Tool						

Unión compatible con perfil G4

UG4



G4
Perfil para subestructura en cubiertas metálicas.



Formato Bulk



Perfiles



Ref	Unidades	Vol. (mm)	Peso (kg)
G6-2350	1	2350x26x50	1,30
	96	2350x500x500	124,90
G6-4800	1	4800x26x29	2,60
	96	4800x471x273	248,50

Accesorios compatibles con Perfil G6	S04	S10	S11	UG6	S36	Clip	BB-Clip	BB-Tool
---	-----	-----	-----	-----	-----	------	---------	---------

Unión compatible con perfil G6	UG6
---------------------------------------	-----

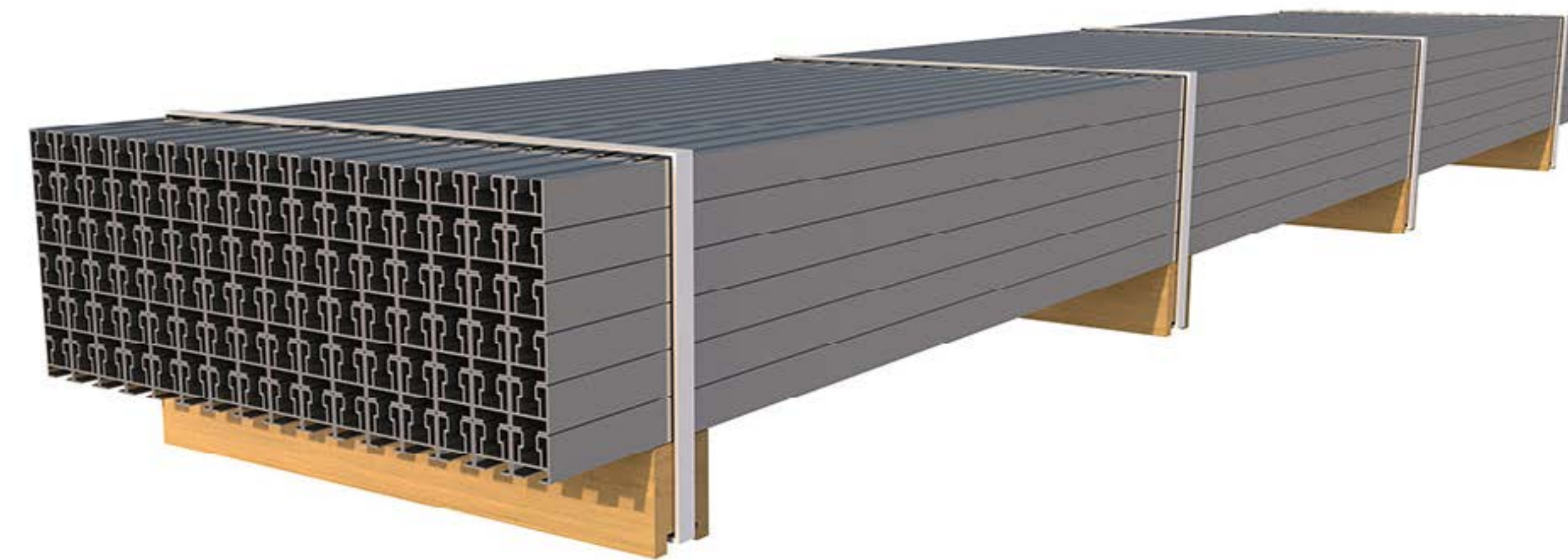

G6
Perfil para instalaciones coplanas en cubiertas metálicas y para subestructuras en cubiertas metálicas.



Formato Bulk

Uniones Perfiles



Ref	Unidades	Vol. (mm)	Peso (kg)
UG1	2	175x100x60	0,40
	25	400x200x120	3,60



Ref	Unidades	Vol. (mm)	Peso (kg)
UG2/UG4-2	2	280x105x65	0,59
UG2/UG4-40	40	400x200x250	8,93



Ref	Unidades	Vol. (mm)	Peso (kg)
UG3	2	175x100x60	0,40
	40	400x200x120	6,40



Ref	Unidades	Vol. (mm)	Peso (kg)
UG6	2	175x100x60	0,08
	25	400x200x80	1,00



Formato Bulk

Presores (Bulk)

Lateral

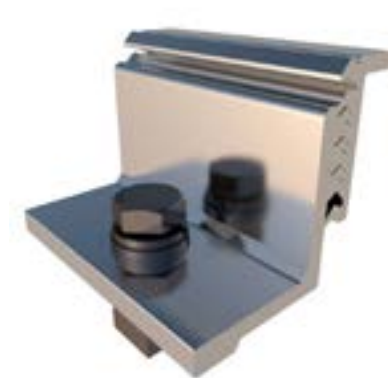

Ref	Unidades	Vol. (mm)	Peso (kg)
S10	2	175x100x60	0,40
	10	280x105x65	1,10
	50	400x200x120	5,30



Ref	Unidades	Vol. (mm)	Peso (kg)
S10-B	2	175x100x60	0,40
	10	280x105x65	1,10
	50	400x200x120	5,30



Ref	Unidades	Vol. (mm)	Peso (kg)
S10.1	10	280x105x65	1,10
	50	400x200x120	5,50

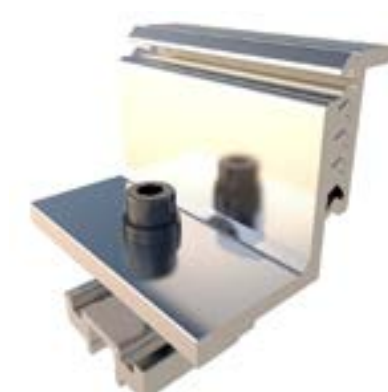

Ref	Unidades	Vol. (mm)	Peso (kg)
S10.3	10	280x105x65	1,60
	50	400x200x120	6,00



Ref	Unidades	Vol. (mm)	Peso (kg)
S12	2	175x100x60	0,40
	10	420x105x65	1,70
	50	400x200x250	7,80

Central



Ref	Unidades	Vol. (mm)	Peso (kg)
S11	2	175x100x60	0,20
	10	280x105x65	0,50
	100	400x200x120	4,60



Ref	Unidades	Vol. (mm)	Peso (kg)
S11B	2	175x100x60	0,20
	10	280x105x65	0,50
	100	400x200x120	4,60



Ref	Unidades	Vol. (mm)	Peso (kg)
S11.1	10	280x105x65	0,60
	100	400x200x120	6,00



Ref	Unidades	Vol. (mm)	Peso (kg)
S11.3	2	175x100x60	0,20
	10	280x105x65	0,53
	100	400x200x120	5,03



Formato Bulk

Cincado



Ref	Longitud (mm)	Unidades	Vol. (mm)	Peso (kg)
S42	6,3x19	100	175x100x60	0,70



Ref	Longitud (mm)	Unidades	Vol. (mm)	Peso (kg)
S42.1	5,5x25	100	175x100x60	0,70



Ref	Longitud (mm)	Unidades	Vol. (mm)	Peso (kg)
S42.2	5,5x70	50	175x100x60	0,58



Ref	Longitud (mm)	Unidades	Vol. (mm)	Peso (kg)
S42.3	6,3x90	50	175x100x60	0,93

Bimetálica



Ref	Longitud (mm)	Unidades	Vol. (mm)	Peso (kg)
S43	5,5x25	100	175x100x60	1,20



Ref	Longitud (mm)	Unidades	Vol. (mm)	Peso (kg)
S43.1	5,5x35	100	175x100x60	1,20



Ref	Longitud (mm)	Unidades	Vol. (mm)	Peso (kg)
S43.2	5,5x70 (Rosca 50)	25	175x100x60	0,35



Ref	Longitud (mm)	Unidades	Vol. (mm)	Peso (kg)
S43.3	5,5x90 (Rosca 50)	25	175x100x60	0,42



Formato Bulk

Inoxidable



Ref	Longit ud (mm)	Unidades	Vol. (mm)	Peso (kg)
CP1		1	Sin caja	8,14



Formato Bulk

Accesorios *Unlimited*



Fijación



Tomatierras



Accesorios
para
estructura

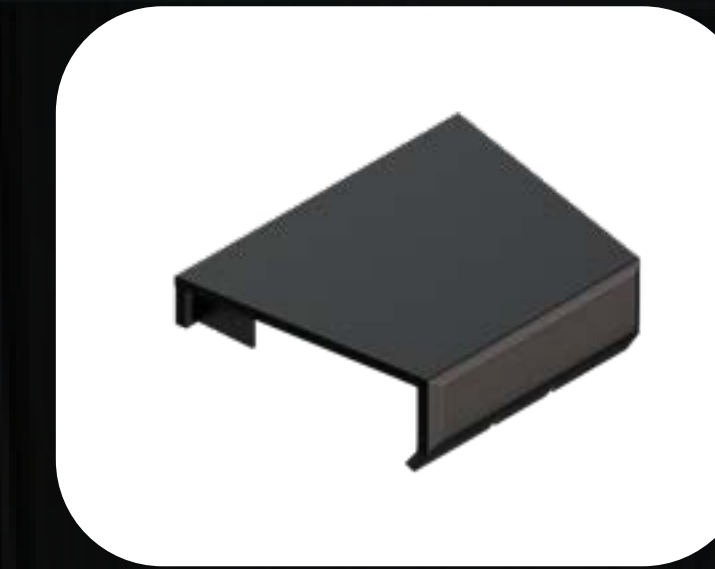

Accesorios
para
módulos

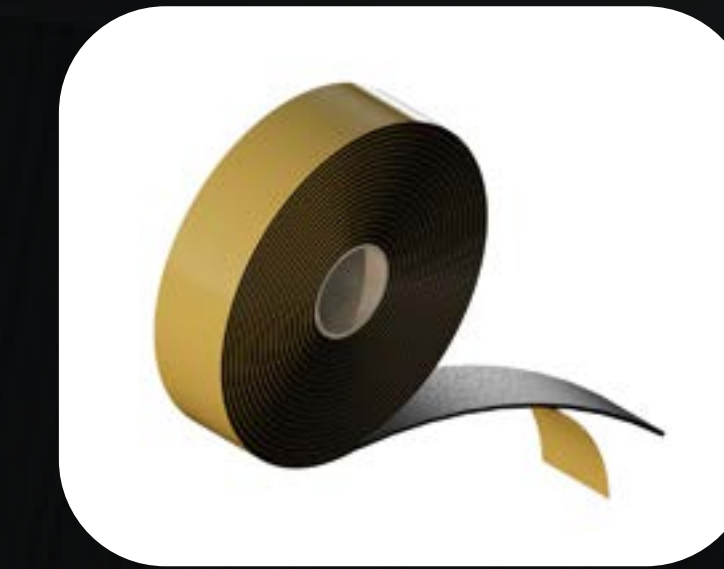

Juntas de
estanqueidad

Taco químico y tamiz



Ref	Unidades	Vol. (mm)	Peso (kg)
S74	15	270x210x265	9,50



Ref	Unidades	Vol. (mm)	Peso (kg)
S75-85	100	400x200x120	0.56



Ref	Unidades	Vol. (mm)	Peso (kg)
S75-130	100	680x185x90	0.76



Formato Bulk

Tomatierras

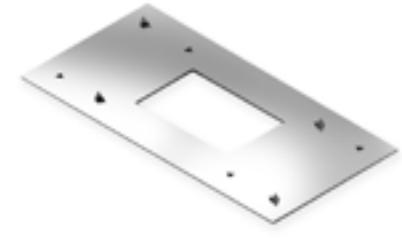

Ref	Unidades	Vol. (mm)	Peso (kg)
S13	10	175x100x60	0,10
	50	175x100x60	0,40



Ref	Unidades	Vol. (mm)	Peso (kg)
S13.3	10	175x100x60	0,10
	50	175x100x60	0,40



Ref	Unidades	Vol. (mm)	Peso (kg)
S13.4	10	175x100x60	0,10
	50	175x100x60	0,40



Formato Bulk

Accesorios para estructura (Unlimited)

Black End



Ref	Unidades	Vol. (mm)	Peso (kg)
BE	40	400x200x250	2.20

Clip pasa cable



Ref	Unidades	Vol. (mm)	Peso (kg)
CP	40	420x105x65	0,38
	100	400x200x80	0,99

Anclaje microinversor



Ref	Unidades	Vol. (mm)	Peso (kg)
S68	4	Sin caja	0,08
	40	175x100x60	0,85



Ref	Unidades	Vol. (mm)	Peso (kg)
S69	4	175x100x60	0,12
	40	280x105x65	0,91



Ref	Unidades	Vol. (mm)	Peso (kg)
S79	4	280x105x65	
	40	280x105x65	0,96

Tapa perfil



Ref	Unidades	Vol. (mm)	Peso (kg)
TG1	40	280x105x65	0,20



Formato Bulk

Accesorios para módulos (Unlimited)

Clip drenaje



Ref	Unidades	Vol. (mm)	Peso (kg)
CD	40	420x105x65	0,33

Bird Blocker



Ref	Unidades	Vol. (mm)	Peso (kg)
BB125-60	60	530x380x110	4,62



Ref	Unidades	Vol. (mm)	Peso (kg)
BB200-60	60	530x380x110	5,54

Otros accesorios



Ref	Unidades	Vol. (mm)	Peso (kg)
BB-Tool	1	230x155x30	0,14



Ref	Unidades	Vol. (mm)	Peso (kg)
BBClip30	50	Sin caja	0,14
BBClip35	50	Sin caja	0,14



Formato Bulk

Juntas de estanqueidad (Unlimited)

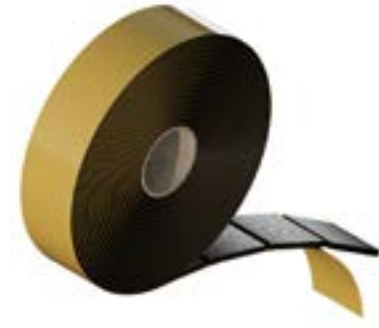

Ref	Unidades	Vol. (ml)	Peso (kg)
S46 (89x20mm)	100	175x100x60	0,10

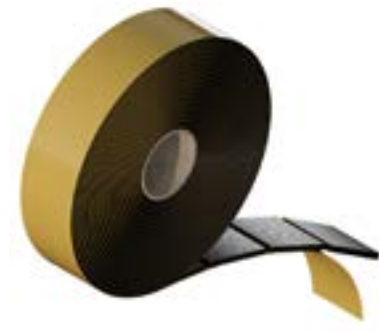

Ref	Unidades	Vol. (ml)	Peso (kg)
S46.1 (50x60mm)	100	175x100x60	0,15

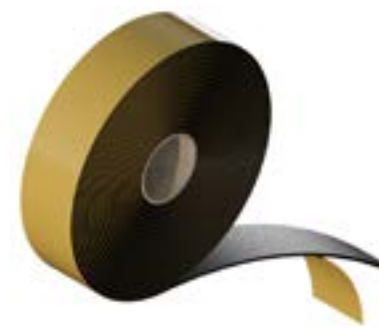

Ref	Unidades	Vol. (ml)	Peso (kg)
S46.2 (20mm)	1 (25m)	175x100x60	0,25



Formato Bulk

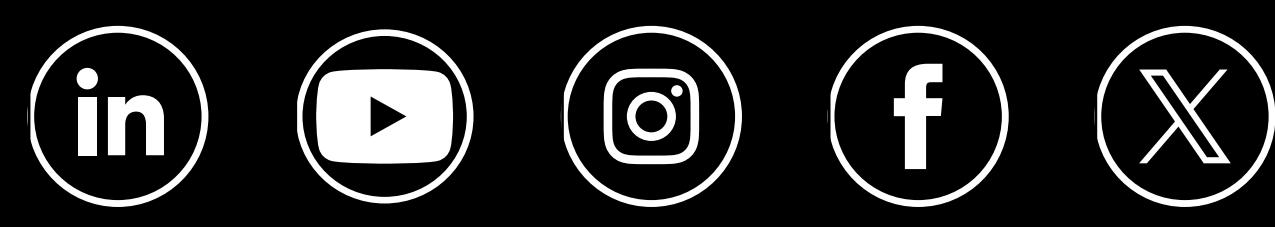

Camino de la Dula s/n 46687 | Albalat de la Ribera | Valencia – Spain
info@sunferenergy.com | +34 962 49 23 22 | sunferenergy.com