

















STPACUSTER
INTERNATIONAL



PRICE LIST 2019

PRODUCTO	CÓDIGO NEGRO	DIÁMETRO	CAJA	PESO x CAJA kg	TIPO	VOLUMEN x CAJA m3	PVP 2019 €
 MANGUITO	ST701016N	16	50	3.80	C	0.019	0.81 €
	ST701020N	20	50	3.55	C	0.019	0.83 €
	ST701025N	25	40	3.70	C	0.019	1.04 €
	ST701032N	32	25	3.66	C	0.019	1.35 €
	ST701040N	40	13	4.07	C	0.019	2.12 €
	ST701050N	50	15	6.09	B	0.037	2.97 €
	ST701063N	63	17	13.04	A	0.074	4.01 €
	ST701075N	75	14	14.72	A	0.074	8.38 €
	ST701090N	90	8	13.10	A	0.074	12.73 €
	ST701110N	110	4	11.53	A	0.074	23.78 €
 MANGUITO REDUCIDO	ST702020N	20-16	45	3.31	C	0.019	0.95 €
	ST702024N	25-16	45	3.77	C	0.019	0.99 €
	ST702025N	25-20	45	3.68	C	0.019	0.99 €
	ST702031N	32-20	30	3.27	C	0.019	1.26 €
	ST702032N	32-25	30	3.59	C	0.019	1.29 €
	ST702039N	40-25	18	3.18	C	0.019	1.82 €
	ST702040N	40-32	18	3.58	C	0.019	1.86 €
	ST702049N	50-32	22	6.37	B	0.037	2.69 €
	ST702050N	50-40	20	6.56	B	0.037	2.73 €
	ST702062N	63-40	20	10.59	A	0.074	3.31 €
	ST702063N	63-50	20	11.91	A	0.074	3.35 €
	ST702075N	75-63	14	13.08	A	0.074	8.38 €
	ST702090N	90-75	8	11.14	A	0.074	12.73 €
	ST702110N	110-90	5	11.73	A	0.074	24.45 €
 ENLACE ROSCA HEMBRA	ST703016N	16-1/2"	90	4.47	C	0.019	0.69 €
	ST703017N	16-3/4"	90	4.47	C	0.019	0.69 €
	ST703020N	20-1/2"	90	5.00	C	0.019	0.72 €
	ST703022N	20-3/4"	90	5.26	C	0.019	0.72 €
	ST703024N	25-1/2"	60	3.84	C	0.019	0.85 €
	ST703025N	25-3/4"	60	3.84	C	0.019	0.85 €
	ST703027N	25-1"	60	4.48	C	0.019	0.91 €
	ST703030N	32-1/2"	35	3.40	C	0.019	1.09 €
	ST703031N	32-3/4"	35	3.40	C	0.019	1.09 €
	ST703032N	32-1"	35	3.40	C	0.019	1.09 €
	ST703033N	32-1" 1/4"	35	3.40	C	0.019	1.09 €
	ST703039N	40-1"	22	3.52	C	0.019	1.56 €
	ST703040N	40-1 1/4"	22	3.60	C	0.019	1.56 €
	ST703041N	40-1 1/2"	22	3.80	C	0.019	1.56 €
	ST703050N	50-1 1/2"	27	6.43	B	0.037	2.18 €
	ST703063N	63-2"	26	12.51	A	0.074	2.98 €
	ST703074N	75-2"	20	12.95	A	0.074	6.02 €
	ST703075N	75-2 1/2"	20	12.94	A	0.074	6.02 €
	ST703090N	90-3"	12	12.49	A	0.074	8.73 €
	ST703110N	110-4"	6	9.96	A	0.074	18.01 €
 ENLACE ROSCA MACHO	ST704016N	16-1/2"	90	3.76	C	0.019	0.50 €
	ST704017N	16-3/4"	90	3.80	C	0.019	0.50 €
	ST704020N	20-1/2"	90	3.58	C	0.019	0.54 €
	ST704021N	20-3/4"	90	3.57	C	0.019	0.54 €
	ST704024N	25-1/2"	60	3.06	C	0.019	0.68 €
	ST704025N	25-3/4"	60	3.16	C	0.019	0.68 €
	ST704026N	25-1"	60	3.24	C	0.019	0.68 €
	ST704031N	32-3/4"	40	3.16	C	0.019	0.90 €
	ST704032N	32-1"	40	3.31	C	0.019	0.90 €
	ST704033N	32-1 1/4"	40	3.46	C	0.019	0.90 €
	ST704038N	40-3/4"	23	3.02	C	0.019	1.29 €
	ST704039N	40-1"	23	3.19	C	0.019	1.29 €
	ST704040N	40-1 1/4"	23	3.32	C	0.019	1.29 €
	ST704041N	40-1 1/2"	22	3.30	C	0.019	1.29 €
	ST704049N	50-1 1/4"	27	6.36	B	0.037	1.57 €
	ST704050N	50-1 1/2"	25	6.57	B	0.037	1.60 €
	ST704051N	50-2"	25	6.14	B	0.037	1.68 €
	ST704062N	63-1 1/2"	30	12.79	A	0.074	2.55 €
	ST704063N	63-2"	30	12.79	A	0.074	2.55 €
	ST704064N	63-2 1/2"	30	12.88	A	0.074	2.55 €
	ST704074N	75-2"	20	12.59	A	0.074	5.28 €
	ST704075N	75-2 1/2"	20	12.25	A	0.074	5.12 €
	ST704076N	75-3"	20	12.25	A	0.074	5.12 €
	ST704090N	90-3"	12	11.50	A	0.074	7.77 €
ST704110N	110-4"	6	10.00	A	0.074	16.19 €	
 TAPÓN	ST705016N	16	125	4.97	C	0.019	0.57 €
	ST705020N	20	125	4.71	C	0.019	0.58 €
	ST705025N	25	75	3.70	C	0.019	0.73 €
	ST705032N	32	50	3.96	C	0.019	0.94 €
	ST705040N	40	24	3.24	C	0.019	1.39 €
	ST705050N	50	30	6.56	B	0.037	1.90 €
	ST705063N	63	30	12.56	A	0.074	2.65 €
	ST705075N	75	23	14.28	A	0.074	5.45 €
	ST705090N	90	16	15.51	A	0.074	8.84 €
	ST705110N	110	8	13.33	A	0.074	17.84 €
 CODO 90°	ST706016N	16	45	3.76	C	0.019	0.83 €
	ST706020N	20	45	3.58	C	0.019	0.85 €
	ST706025N	25	30	3.04	C	0.019	1.05 €
	ST706032N	32	20	3.26	C	0.019	1.48 €
	ST706040N	40	10	2.83	C	0.019	2.29 €
	ST706050N	50	12	5.45	B	0.037	3.20 €
	ST706063N	63	14	12.65	A	0.074	4.41 €
	ST706075N	75	9	10.76	A	0.074	9.11 €
	ST706090N	90	6	11.68	A	0.074	13.43 €
	ST706110N	110	3	10.04	A	0.074	30.40 €
 CODO MACHO 90°	ST707016N	16-1/2"	70	3.77	C	0.019	0.70 €
	ST707020N	20-1/2"	70	3.74	C	0.019	0.74 €
	ST707021N	20-3/4"	70	3.74	C	0.019	0.74 €
	ST707024N	25-1/2"	40	3.09	C	0.019	0.96 €
	ST707025N	25-3/4"	40	2.84	C	0.019	0.96 €
	ST707026N	25-1"	40	2.84	C	0.019	0.96 €
	ST707031N	32-3/4"	30	3.90	C	0.019	1.34 €
	ST707032N	32-1"	30	3.81	C	0.019	1.34 €
	ST707033N	32-1 1/4"	30	3.90	C	0.019	1.43 €
	ST707039N	40-1"	15	3.01	C	0.019	1.90 €
	ST707040N	40-1 1/4"	15	3.01	C	0.019	1.90 €
	ST707050N	50-1 1/2"	18	6.24	B	0.037	2.61 €
ST707063N	63-2"	20	12.68	A	0.074	3.29 €	



PRODUCTO	CÓDIGO NEGRO	DIÁMETRO	CAJA	PESO x CAJA kg	TIPO	VOLUMEN x CAJA m3	PVP 2019 €
	ST708016N	16-1/2"	70	4.37	C	0.019	0.84 €
	ST708020N	20-1/2"	70	4.04	C	0.019	0.85 €
	ST708021N	20-3/4"	70	4.04	C	0.019	0.85 €
	ST708024N	25-1/2"	40	3.38	C	0.019	1.14 €
	ST708025N	25-3/4"	40	3.03	C	0.019	1.14 €
	ST708026N	25-1"	30	3.03	C	0.019	1.14 €
	ST708029N	32-1/2"	30	4.28	C	0.019	1.49 €
	ST708031N	32-3/4"	30	4.24	C	0.019	1.49 €
	ST708032N	32-1"	30	3.72	C	0.019	1.52 €
	ST708033N	32-1 1/4"	30	3.70	C	0.019	1.91 €
	ST708039N	40-1"	15	3.49	C	0.019	2.21 €
	ST708040N	40-1 1/4"	15	3.11	C	0.019	2.21 €
	ST708050N	50-1 1/2"	18	6.45	B	0.037	3.00 €
	ST708063N	63-2"	20	13.41	A	0.074	3.78 €
	ST708075N	75-2 1/2"	14	11.97	A	0.074	8.25 €
	ST708090N	90-3"	8	11.25	A	0.074	10.91 €
ST708110N	110-4"	4	9.20	A	0.074	25.00 €	
	ST709016N	16	30	3.76	C	0.019	1.28 €
	ST709020N	20	30	3.46	C	0.019	1.29 €
	ST709025N	25	20	2.95	C	0.019	1.59 €
	ST709032N	32	12	2.88	C	0.019	2.04 €
	ST709040N	40	5	2.05	C	0.019	3.71 €
	ST709050N	50	8	5.26	B	0.037	4.69 €
	ST709063N	63	8	10.28	A	0.074	5.87 €
	ST709075N	75	5	9.26	A	0.074	13.84 €
	ST709090N	90	4	11.61	A	0.074	20.48 €
	ST709110N	110	1	4.80	A	0.074	40.97 €
	ST710016N	16-1/2"	40	4.21	C	0.019	1.12 €
	ST710020N	20-1/2"	40	3.72	C	0.019	1.14 €
	ST710021N	20-3/4"	40	3.72	C	0.019	1.14 €
	ST710024N	25-1/2"	25	3.26	C	0.019	1.45 €
	ST710025N	25-3/4"	25	3.12	C	0.019	1.45 €
	ST710026N	25-1"	25	3.12	C	0.019	1.45 €
	ST710029N	32-1/2"	15	3.20	C	0.019	2.02 €
	ST710031N	32-3/4"	15	3.17	C	0.019	2.02 €
	ST710032N	32-1"	15	2.97	C	0.019	2.02 €
	ST710033N	32-1 1/4"	15	2.80	C	0.019	2.51 €
	ST710039N	40-1"	8	2.84	C	0.019	3.06 €
	ST710040N	40-1 1/4"	8	2.65	C	0.019	3.06 €
	ST710050N	50-1 1/2"	10	5.76	B	0.037	4.07 €
	ST710062N	63-1 1/2"	11	11.59	A	0.074	5.96 €
	ST710063N	63-2"	11	11.60	A	0.074	5.96 €
	ST710075N	75-2 1/2"	10	14.59	A	0.074	10.89 €
ST710090N	90-3"	4	9.61	A	0.074	15.98 €	
ST710110N	110-4"	2	4.99	A	0.074	32.62 €	
	ST711016N	16-1/2"	40	3.63	C	0.019	0.89 €
	ST711020N	20-1/2"	40	3.63	C	0.019	0.89 €
	ST711021N	20-3/4"	40	3.75	C	0.019	0.89 €
	ST711024N	25-1/2"	30	3.44	C	0.019	1.24 €
	ST711025N	25-3/4"	30	3.44	C	0.019	1.24 €
	ST711026N	25-1"	30	3.60	C	0.019	1.24 €
	ST711031N	32-3/4"	15	2.80	C	0.019	1.72 €
	ST711032N	32-1"	15	2.93	C	0.019	1.72 €
	ST711033N	32-1 1/4"	15	2.97	C	0.019	1.72 €
	ST711039N	40-1"	9	2.98	C	0.019	2.45 €
	ST711040N	40-1 1/4"	9	2.98	C	0.019	2.45 €
	ST711050N	50-1 1/2"	10	5.45	B	0.037	3.41 €
	ST711063N	63-2"	12	12.14	A	0.074	5.11 €
		ST712016N	16-1/2"	50	3.30	C	0.019
ST712020N		20-1/2"	50	3.30	C	0.019	1.09 €
ST712025N		25-3/4"	40	3.45	C	0.019	1.35 €
	ST713020N	20-16	20	2.80	C	0.019	1.32 €
	ST713024N	25-16	20	2.92	C	0.019	1.56 €
	ST713025N	25-20	20	2.92	C	0.019	1.56 €
	ST713032N	32-25	12	2.75	C	0.019	1.98 €
	ST713040N	40-32	8	3.12	C	0.019	3.58 €
	ST713049N	50-32	8	5.23	B	0.037	4.25 €
	ST713050N	50-40	8	5.23	B	0.037	4.38 €
ST713063N	63-50	8	9.32	A	0.074	5.48 €	
	ST710030N	32x3/4"x3/4"	15	3.58	C	0.019	3.38 €
	ST714050N	50	10	11.60	B	0.037	7.11 €
	ST714063N	63	18	27.46	A	0.074	8.71 €
	ST714075N	75	10	19.53	A	0.074	12.23 €
	ST714090N	90	8	18.87	A	0.074	19.66 €
	ST714110N	110	6	18.40	A	0.074	28.10 €
	ST725050N	50	15	6.09	B	0.037	3.29 €
	ST725063N	63	17	13.04	A	0.074	4.46 €
	ST725075N	75	14	14.72	A	0.074	9.31 €
	ST725090N	90	8	13.10	A	0.074	14.14 €
	ST725110N	110	4	11.53	A	0.074	26.43 €
	ST726024N	25-16	35	3.55	C	0.019	1.01 €
	ST726025N	25-20	35	3.55	C	0.019	1.01 €
	ST726032N	32-25	20	3.26	C	0.019	1.42 €









PRODUCTO	CÓDIGO NEGRO	DIÁMETRO	CAJA	PESO x CAJA kg	TIPO	VOLUMEN x CAJA m3	PVP 2019 €
RECAMBIOS							
		16					0.03 €
		20					0.03 €
		25					0.05 €
		32					0.07 €
		40					0.10 €
		50					0.16 €
		63					0.29 €
		75					0.66 €
		90					0.89 €
	110					1.08 €	
		16					0.06 €
		20					0.04 €
		25					0.05 €
		32					0.08 €
		40					0.09 €
		50					0.16 €
		63					0.30 €
		75					0.60 €
		90					0.67 €
	110					1.51 €	
		16					0.06 €
		20					0.03 €
		25					0.04 €
		32					0.08 €
		40					0.09 €
		50					0.15 €
		63					0.20 €
		75					0.25 €
		90					0.34 €
	110					0.75 €	
	ST000220N	16/20					0.18 €
	ST000225N2	25					0.23 €
	ST000232N2	32					0.30 €
	ST000240N2	40					0.42 €
	ST000250N2	50					0.53 €
	ST000263N2	63					0.83 €
	ST000275N2	75					1.65 €
	ST000290N2	90					3.17 €
	ST000211N2	110					4.43 €
		20	1400	4.6	B	0.037	0.13 €
		25	800	7.1	B	0.037	0.14 €
		32	400	13.7	B	0.037	0.19 €
		40	250	5	B	0.074	0.30 €
		50	150	5.1	B	0.074	0.37 €
		63	92	6.26	B	0.074	0.38 €
		16	1300		C		0.12 €
		20	800		C		0.18 €
		25	460		C		0.13 €
		32	270		C		0.23 €
STP PRODUCTO							
	ST141016CN	16	65	11.05	B	0.037	4.14 €
	ST141020CN	20	65	16.25	B	0.037	4.14 €
	ST141025CN	25	30	9.60	B	0.037	5.25 €
	ST141032CN	32	25	8.50	B	0.037	5.96 €
	ST141040CN	40	12	8.64	B	0.037	8.19 €
	ST141050CN	50	12	10.56	B	0.037	9.30 €
	ST141063CN	63	5	7.40	B	0.037	13.85 €
	ST140016CXN	16x1/2"	65	11.05	B	0.037	4.39 €
	ST140020CXN	20x1/2"	65	16.25	B	0.037	4.39 €
	ST140025CXN	25x3/4"	30	9.60	B	0.037	5.04 €
	ST140032CXN	32x1"	25	8.50	B	0.037	5.49 €
	ST140040CXN	40x1 1/4"	12	8.64	B	0.037	8.68 €
	ST140050CXN	50x1 1/2"	12	10.56	B	0.037	9.49 €
ST140063CXN	63x2"	5	7.40	B	0.037	14.24 €	
	ST142016CN	16x1/2"	65	11.05	B	0.037	4.39 €
	ST142020CN	20x1/2"	65	16.25	B	0.037	4.39 €
	ST142025CN	25x3/4"	30	9.60	B	0.037	5.04 €
	ST142032CN	32x1"	25	8.50	B	0.037	5.49 €
	ST142040CN	40x1 1/4"	12	8.64	B	0.037	8.68 €
	ST142050CN	50x1 1/2"	12	10.56	B	0.037	9.49 €
ST142063CN	63x2"	5	7.40	B	0.037	14.24 €	
	ST146016CFN	16x1/2"	100	8.00	B	0.037	2.73 €
	ST146020CFN	20x1/2"	100	8.00	B	0.037	2.73 €
	ST146025CFN	25x3/4"	40	8.00	B	0.037	3.54 €
	ST146026CFN	25x1"	40	10.20	B	0.037	3.54 €
	ST146032CFN	32x1"	40	12.80	B	0.037	4.03 €
	ST146040CFN	40x1 1/4"	15	9.60	B	0.037	7.18 €
	ST146050CFN	50x1 1/2"	15	12.00	B	0.037	8.02 €
	ST146063CFN	63x2"	8	7.84	B	0.037	11.99 €
	ST147016CMN	16x1/2"	100	8.00	B	0.037	2.73 €
	ST147020CMN	20x1/2"	100	8.00	B	0.037	2.73 €
	ST147025CMN	25x3/4"	40	8.00	B	0.037	3.54 €
	ST147026CMN	25x1"	40	10.20	B	0.037	3.54 €
	ST147032CMN	32x1"	40	12.80	B	0.037	4.03 €
	ST147040CMN	40x1 1/4"	15	9.60	B	0.037	7.18 €
	ST147050CMN	50x1 1/2"	15	12.00	B	0.037	8.02 €
	ST147063CMN	63x2"	8	7.84	B	0.037	11.99 €

ACCESORIOS EN PP DE COMPRESIÓN



ACCESORIOS Y VÁLVULAS DE COMPRESIÓN PP PLAST



PRODUCTO	CÓDIGO NEGRO	DIÁMETRO	CAJA	PESO x CAJA kg	TIPO	VOLUMEN x CAJA m3	PVP 2019 €
 VÁLVULA ANTI RETORNO PE-PE	ST143016CN	16	65	6.57	B	0.037	5.39 €
	ST143020CN	20	65	6.57	B	0.037	5.39 €
	ST143025CN	25	35	7.59	B	0.037	7.43 €
	ST143032CN	32	25	7.05	B	0.037	7.81 €
	ST143040CN	40	12	6.86	B	0.037	9.77 €
	ST143050CN	50	12	8.65	B	0.037	10.55 €
	ST143063CN	63	5	6.40	B	0.037	16.05 €
 VÁLVULA ANTI RETORNO PE-PP/PVC ROSCA HEMBRA	ST144016CN	16x1/2"	65	5.86	B	0.037	5.14 €
	ST144020CN	20x1/2"	65	5.86	B	0.037	5.14 €
	ST144025CN	25x3/4"	35	7.20	B	0.037	7.22 €
	ST144032CN	32x1"	25	6.10	B	0.037	7.49 €
	ST144040CN	40x1 1/4"	12	6.20	B	0.037	9.21 €
	ST144050CN	50x1 1/2"	12	7.29	B	0.037	9.64 €
	ST144063CN	63x2"	5	5.30	B	0.037	14.50 €
 VÁLVULA ANTI RETORNO PE-PP/PVC ENCOLAR HEMBRA	ST144016CXN	16x16	65	5.86	B	0.037	5.14 €
	ST144020CXN	20x20	65	5.86	B	0.037	5.14 €
	ST144025CXN	25x25	35	7.20	B	0.037	7.22 €
	ST144032CXN	32x32	25	6.10	B	0.037	7.49 €
	ST144040CXN	40x40	12	6.20	B	0.037	9.21 €
	ST144050CXN	50x50	12	7.29	B	0.037	9.64 €
	ST144063CXN	63x63	5	5.30	B	0.037	14.50 €
 VÁLVULA ANTI RETORNO PE-PP/PVC ROSCA MACHO	ST145016CN	16x1/2"	65	6.05	B	0.037	5.24 €
	ST145020CN	20x1/2"	65	6.05	B	0.037	5.24 €
	ST145025CN	25x3/4"	35	7.52	B	0.037	7.37 €
	ST145032CN	32x1"	25	6.33	B	0.037	7.59 €
	ST145040CN	40x1 1/4"	12	6.43	B	0.037	9.31 €
	ST145050CN	50x1 1/2"	12	7.34	B	0.037	9.75 €
	ST145063CN	63x2"	5	5.37	B	0.037	14.80 €
 VÁLVULA ANTI RETORNO UNIBLOCK PE-PP/PVC ROSCA HEMBRA	ST148016CFN	16x1/2"	100	6.00	B	0.037	3.82 €
	ST148020CFN	20x1/2"	100	6.00	B	0.037	3.82 €
	ST148025CFN	25x3/4"	60	9.62	B	0.037	4.70 €
	ST148032CFN	32x1"	50	8.50	B	0.037	4.88 €
	ST148040CFN	40x1 1/4"	15	5.75	B	0.037	7.45 €
	ST148050CFN	50x1 1/2"	15	6.22	B	0.037	7.87 €
	ST148063CFN	63x2"	8	5.58	B	0.037	11.46 €
 VÁLVULA ANTI RETORNO UNIBLOCK PE-PP/PVC ROSCA MACHO	ST149016CMN	16x1/2"	100	6.00	B	0.037	3.82 €
	ST149020CMN	20x1/2"	100	6.00	B	0.037	3.82 €
	ST149025CMN	25x3/4"	60	9.62	B	0.037	4.70 €
	ST149032CMN	32x1"	50	8.50	B	0.037	4.88 €
	ST149040CMN	40x1 1/4"	15	5.75	B	0.037	7.45 €
	ST149050CMN	50x1 1/2"	15	6.22	B	0.037	7.87 €
	ST149063CMN	63x2"	8	5.58	B	0.037	11.46 €

ACCESORIOS DE COMPRESIÓN



ACCESORIOS DE COMPR. PARA TRANSICIONES UNIVERSALES (T-PLAST)



PRODUCTO	CÓDIGO	DIÁMETRO	CAJA	PESO x CAJA kg	TIPO	VOLUMEN x CAJA m3	PVP 2019 €
 MANGUITO DE TRANSICION	ST716016	15-22 (1/2")-16	45	4,65	C	0,019	4,19
	ST716020	15-22 (1/2")-20	45	4,56	C	0,019	4,19
	ST716025	15-22 (1/2")-25	40	4,49	C	0,019	4,24
	ST716032	15-22 (1/2")- 32	30	4,18	C	0,019	4,47
	ST716040	15-22 (1/2")-40	18	3,58	C	0,019	4,54
	ST717020	21-27 (3/4")-20	30	3,95	C	0,019	4,81
	ST717025	21-27 (3/4")-25	30	4,26	C	0,019	4,84
	ST717032	21-27 (3/4")-32	25	4,22	C	0,019	4,89
	ST717040	21-27 (3/4")-40	18	3,98	C	0,019	5,36
	ST717050	21-27 (3/4")-50	18	5,21	B	0,019	5,60
	ST718025	27-35 (1")-25	18	3,96	C	0,019	5,74
	ST718032	27-35 (1")-32	18	4,36	C	0,019	5,77
	ST718040	27-35 (1")-40	12	3,53	C	0,019	5,99
	ST718050	27-35 (1")-50	10	3,71	B	0,019	6,54
	ST718063	27-35 (1")-63	10	5,46	B	0,037	6,84
	ST719032	35-50 (1 1/2)-32	18	5,21	B	0,037	7,99
	ST719040	35-50 (1 1/2)-40	16	5,25	B	0,037	8,49
	ST719050	35-50 (1 1/2)-50	12	4,87	B	0,037	10,33
ST719063	35-50 (1 1/2)-63	18	10,70	A	0,074	10,83	
 CODO 90° TRANSICION	ST723019	15-22 (1/2")-16	35	2,95	C	0,019	3,40
	ST723020	15-22 (1/2")-20	35	3,55	C	0,019	3,41
	ST723021	15-22 (1/2")-25	20	2,92	C	0,019	3,45
	ST723025	21-27 (3/4")-25	20	3,26	C	0,019	3,94
	ST723026	21-27 (3/4")-32	12	3,40	C	0,019	4,07
	ST723033	27-35 (1")-40	12	3,52	C	0,019	5,01
 ENLACE HEMBRA DE TRANSICION	ST720020	15-22 (1/2")-1/2"	60	4,00	C	0,019	3,34
	ST720021	15-22 (1/2")-3/4"	60	4,78	C	0,019	3,34
	ST720022	15-22 (1/2")-1"	60	5,22	C	0,019	3,37
	ST720025	21-27 (3/4")-3/4"	35	4,39	C	0,019	3,82
	ST720026	21-27 (3/4")-1"	35	4,59	C	0,019	3,82
	ST720027	21-27 (3/4")-1 1/4"	35	4,83	C	0,019	4,16
	ST720032	27-35 (1")-1"	22	4,87	C	0,019	4,50
	ST720033	27-35 (1")-1 1/4"	22	4,93	C	0,019	4,50
	ST720034	27-35 (1")-1 1/2"	22	5,05	C	0,019	4,50
	ST720041	35-50 (1 1/2")-1 1/2"	22	6,48	B	0,037	10,00
 ENLACE MACHO DE TRANSICION	ST721020	15-22 (1/2")-1/2"	60	4,50	C	0,019	3,15
	ST721021	15-22 (1/2")-3/4"	60	4,33	C	0,019	3,15
	ST721022	15-22 (1/2")-1"	60	4,62	C	0,019	3,15
	ST721025	21-27 (3/4")-3/4"	35	3,56	C	0,019	3,62
	ST721026	21-27 (3/4")-1"	35	3,82	C	0,019	3,62
	ST721027	21-27 (3/4")-1 1/4"	35	3,82	C	0,019	3,62
	ST721032	27-35 (1")-1"	25	4,73	C	0,019	4,24
	ST721033	27-35 (1")-1 1/4"	23	4,39	C	0,019	4,24
	ST721034	27-35 (1")-1 1/2"	22	4,25	C	0,019	4,24
	ST721040	35-50 (1 1/2")-1 1/4"	22	4,16	B	0,037	9,04
	ST721041	35-50 (1 1/2")-1 1/2"	22	3,86	B	0,037	9,04
	ST721042	35-50 (1 1/2")-2"	22	3,74	B	0,037	9,04

PRODUCTO	CÓDIGO	DIÁMETRO	CAJA	PESO x CAJA kg	TIPO	VOLUMEN x CAJA m3	PVP 2019 €
 CODO 90° HEMBRA DE TRANS	ST723220	15-22 (1/2")-1/2"	40	3,38	C	0,019	3,55
	ST723221	15-22 (1/2")-3/4"	40	3,82	C	0,019	3,55
	ST723224	21-27 (3/4")-1/2"	30	4,85	C	0,019	4,13
	ST723225	21-27 (3/4")-3/4"	30	4,91	C	0,019	4,13
	ST723226	21-27 (3/4")-1"	30	4,95	C	0,019	4,14
	ST723227	21-27 (3/4")-1 1/4"	30	4,98	C	0,019	4,14
	ST723232	27-35 (1")-1"	15	3,49	C	0,019	5,00
	ST723233	27-35 (1")-1 1/4"	15	3,11	C	0,019	5,00
 CODO 90° MACHO DE TRANSI	ST723120	15-22 (1/2")-1/2"	40	3,52	C	0,019	3,38
	ST723121	15-22 (1/2")-3/4"	40	3,62	C	0,019	3,38
	ST723125	21-27 (3/4")-3/4"	30	3,90	C	0,019	3,94
	ST723126	21-27 (3/4")-1"	30	3,81	C	0,019	3,94
	ST723127	21-27 (3/4")-1 1/4"	30	3,86	C	0,019	3,94
	ST723132	27-35 (1")-1"	15	2,97	C	0,019	4,71
	ST723133	27-35 (1")-1 1/4"	15	3,01	C	0,019	4,71
	 TAPÓN UNIVERSAL	ST722020	15-22 (1/2")	75	3,70	C	0,019
ST722025		21-27 (3/4")	50	3,96	C	0,019	3,64
ST722032		27-35 (1")	24	3,24	C	0,019	4,32
ST722040		35-50 (1 1/2")	24	5,25	B	0,019	9,02
 CODO GRIFO UNIVERSAL		ST722121	15-22 (1/2")-3/4"	35	3,50	C	0,019
	 TE MACHO TRANSICION UNIV	ST724220	15-22 (1/2")-1/2"-25	25	3,37	C	0,019
ST724221		15-22 (1/2")-3/4"-25	25	3,37	C	0,019	3,58
ST724225		21-27 (3/4")-3/4"-32	14	3,03	C	0,019	4,24
ST724226		21-27 (3/4")-1"-32	14	3,15	C	0,019	4,24
ST724227		21-27 (3/4")-1 1/4"-32	14	3,17	C	0,019	4,24
ST724233		27-35 (1")-1 1/4"-40	8	3,05	C	0,019	5,13
 TE HEMBRA TRANSICION UNIV.		ST724120	15-22 (1/2")-1/2"-25	25	4,00	C	0,019
	ST724121	15-22 (1/2")-3/4"-25	25	4,07	C	0,019	3,79
	ST724124	21-27 (3/4")-1/2"-32	14	3,41	C	0,019	4,52
	ST724125	21-27 (3/4")-3/4"-32	14	3,38	C	0,019	4,52
	ST724126	21-27 (3/4")-1"-32	14	3,19	C	0,019	4,52
	ST724127	21-27 (3/4")-1 1/4"-32	14	3,03	C	0,019	4,52
	ST724132	27-35 (1")-1"-40	8	3,25	C	0,019	5,63
	ST724133	27-35 (1")-1 1/4"-40	8	3,05	C	0,019	5,63



ACCESORIOS DE COMPR. PARA TRANSICIONES UNIVERSALES (T-PLAST)



PRODUCTO	CÓDIGO	DIÁMETRO	CAJA	PESO x CAJA kg	TIPO	VOLUMEN x CAJA m3	PVP 2019 €	
	ST724001	15-22 (1/2")- 25 - 25	18	3,40	C	0,019	3,85	
	ST724002	15-22 (1/2")- 25 - 15-22 (1/2")	18	3,75	C	0,019	6,50	
	ST724003	15-22 (1/2")- 20 - 25	18	3,38	C	0,019	3,83	
	ST724004	15-22 (1/2")- 20 - 15-22 (1/2")	18	3,40	C	0,019	6,47	
	ST724005	21-27 (3/4")- 32 - 32	10	2,70	C	0,019	4,50	
	ST724006	21-27 (3/4")- 32 - 21-27 (3/4")	10	3,00	C	0,019	7,45	
	ST724007	21-27 (3/4")- 25 - 32	10	2,50	C	0,019	4,44	
	ST724008	21-27 (3/4")- 25 - 21-27 (3/4")	10	2,80	C	0,019	7,37	
	ST724010	32 - 15-22 (1/2") - 32	10	2,49	C	0,019	4,15	
	ST724011	27-35 (1")- 40 - 40	6	3,13	C	0,019	6,08	
	ST724012	27-35 (1")- 40 - 27-35 (1")	6	3,27	C	0,019	9,35	
	ST724013	27-35 (1")- 32 - 40	6	2,92	C	0,019	5,99	
	TE TRANSICION UNIVERSAL	ST724014	27-35 (1")- 32 - 27-35 (1")	6	2,87	C	0,019	9,26
		ST724016	40 - 21-27 (3/4") - 40	8	3,36	C	0,019	5,67





ACCESORIOS DE COMPR. PARA TRANSICIONES UNIVERSALES (RE-PLAST)



PRODUCTO	CÓDIGO	DIÁMETRO	CAJA	PESO x CAJA kg	TIPO	VOLUMEN x CAJA m3	PVP 2019 €	
	ST730101	15-22 (1/2") - 15-22 (1/2")	30	4,11	C	0,019	6,08	
	ST730102	15-22 (1/2") - 21-27 (3/4")	25	3,30	C	0,019	6,56	
	ST730103	15-22 (1/2") - 27-35 (1")	16	3,95	C	0,019	7,30	
	ST730104	21-27 (3/4") - 21-27 (3/4")	22	4,18	C	0,019	6,91	
	ST730105	21-27 (3/4") - 27-35 (1")	15	4,16	C	0,019	7,62	
	ST730106	21-27 (3/4") - 35-50 (1 1/2")	8	2,32	C	0,019	8,60	
	ST730107	27-35 (1") - 27-35 (1")	12	4,15	C	0,019	8,14	
	MANGUITO REPARACION UNIV	ST730108	27-35 (1") - 35-50 (1 1/2")	8	3,05	C	0,019	8,97
		ST730109	35-50 (1 1/2") - 35-50 (1 1/2")	8	3,57	B	0,037	14,03

							
	ST730202	15-22 (1/2")- 21-27 (3/4")	18	3,06	C	0,019	6,71
CODO 90° REPARACIÓN UNIV.							

							
	ST730302	21-27 (3/4") - 15-22 (1/2") - 21-27 (3/4")	10	3,06	C	0,019	10,02
	ST730304	27-35 (1") - 21-27 (3/4") - 27-35 (1")	6	3,17	C	0,019	12,20
TE 90° REPARACIÓN UNIV.							

							
	ST730401	15-22 (1/2")-1/2"	20	3,52	C	0,019	6,49
	ST730402	15-22 (1/2")-3/4"	20	3,38	C	0,019	6,49
	ST730407	21-27 (3/4")-1/2"	14	3,8	C	0,019	7,51
	ST730403	21-27 (3/4")-3/4"	14	3,75	C	0,019	7,51
STPACUSTER	ST730404	21-27 (3/4")-1"	14	3,57	C	0,019	7,51



ACCESORIOS DE COMPR. PARA TRANSICIONES UNIVERSALES (T-PLAST)



PRODUCTO	CÓDIGO	DIÁMETRO	CAJA	PESO x CAJA kg	TIPO	VOLUMEN x CAJA m3	PVP 2019 €
TE HEMBRA REPARACION UN	ST730408	21-27 (3/4")-1 1/4"	14	3,5	C	0,019	7,51
	ST730405	27-35 (1")-1"	8	3,43	C	0,019	8,97
	ST730406	27-35 (1")-1 1/4"	8	3,41	C	0,019	8,97

	ST730501	15-22 (1/2")-1/2"	20	3,20	C	0,019	6,23
	ST730502	15-22 (1/2")-3/4"	20	3,18	C	0,019	6,23
	ST730505	21-27 (3/4")-3/4"	14	3,60	C	0,019	7,17
	ST730503	21-27 (3/4")-1"	14	3,50	C	0,019	7,17
	ST730508	21-27 (3/4")-1 1/4"	14	3,70	C	0,019	7,17
	ST730504	27-35 (1")-1 1/4"	8	3,38	C	0,019	8,39
	TE MACHO REPARACION UN						

	ST715015	15-21	40	2,00	C	0,019	3,30
	ST715021	21-27	30	2,40	C	0,019	3,68
	ST715027	27-35	20	2,60	C	0,019	4,08
	ST715035	35-50	10	1,50	C	0,019	7,02
	KIT ACCESORIO UNIVERSAL						

	ST715220CU	1/2"	40	2,00	C	0,019	1,44
	ST715225CU	3/4"	40	2,20	C	0,019	1,82
	KIT ADAPTADOR COBRE						

ACCESORIOS DE COMPRESIÓN PP UNIVERSALES

PRODUCTO	CÓDIGO	DIÁMETRO	CAJA	PESO x CAJA kg	TIPO	VOLUMEN x CAJA m3	PVP 2019 €
	ST141024CU	25 -(15-22)	30	6,43	B	0,037	10,99
	ST141025CU	25 -(21-27)	30	6,43	B	0,037	10,99
	ST141031CU	32 -(15-22)	25	6,03	B	0,037	11,27
	ST141032CU	32 -(21-27)	25	6,37	B	0,037	14,11
	ST141040CU	40 -(27-35)	12	6,27	B	0,037	14,32
	ST141050CU	40 -(35-50)	8	8,00	B	0,037	22,91
COMPRESIÓN PE x UNIVERSAL							

	ST140025U	(15-22)-(15-22)	30	10,80	B	0,037	13,78
	ST140031U	(21-27)-(15-22)	25	9,25	B	0,037	14,60
	ST140032U	(21-27)-(21-27)	25	10,00	B	0,037	15,09
	ST140040U	(27-35)-(27-35)	12	9,84	B	0,037	18,29
	ST140050U	(35-50)-(35-50)	8	10,96	B	0,037	29,27
	COMPRESIÓN UNIVERSAL x UNIVERSAL						

PRICE LIST 2019

PRODUCTO	CÓDIGO	DIÁMETRO	CAJA	PESO x CAJA kg	TIPO	VOLUMEN x CAJA m3	PVP 2019 €
 COMP. UNIVERSAL. x ROSCA HEMBRA	ST141025UM	(15-22) x 3/4"	30	6,43	B	0,037	10,66
	ST141030UM	(15-22) x 1"	25	6,03	B	0,037	11,01
	ST141031UM	(21-27) x 3/4"	25	6,20	B	0,037	11,51
	ST141032UM	(21-27) x 1"	25	6,37	B	0,037	11,51
	ST141040UM	(27-35) x 1 1/4"	12	6,15	B	0,037	14,92
	ST141041UM	(27-35) x 1 1/2"	12	6,20	B	0,037	14,92
	ST141049UM	(35-50) x 1 1/4"	8	7,80	B	0,037	26,87
	ST141050UM	(35-50) x 1 1/2"	8	7,90	B	0,037	26,87



 COMP. UNIVERSAL. x ROSCA MACHO	ST142025UM	(15-22) x 3/4"	30	6,43	B	0,037	10,66
	ST142030UM	(15-22) x 1"	25	6,03	B	0,037	11,01
	ST142031UM	(21-27) x 3/4"	25	6,20	B	0,037	11,51
	ST142032UM	(21-27) x 1"	25	6,37	B	0,037	11,51
	ST142040UM	(27-35) x 1 1/4"	12	6,15	B	0,037	14,92
	ST142041UM	(27-35) x 1 1/2"	12	6,20	B	0,037	14,92
	ST142049UM	(35-50) x 1 1/4"	8	7,80	B	0,037	26,87
	ST142050UM	(35-50) x 1 1/2"	8	7,90	B	0,037	26,87

 UNIBLOCK COMP. UNIVERSAL x ROSCA HEMBRA	ST146020UF	(15-22) x 3/4"	30	6,12	B	0,037	7,16
	ST146025UF	(21-27) x 1"	25	8,16	B	0,037	7,85
	ST146032UF	(27-35) x 1 1/4"	12	7,83	B	0,037	11,27
	ST146040UF	(35-50) x 1 1/2"	8	6,53	B	0,037	14,08

 UNIBLOCK COMP. UNIVERSAL x ROSCA MACHO	ST147020UM	(15-22) x 3/4"	30	6,12	B	0,037	7,16
	ST147025UM	(21-27) x 1"	25	8,16	B	0,037	7,85
	ST147032UM	(27-35) x 1 1/4"	12	7,83	B	0,037	11,27
	ST147040UM	(35-50) x 1 1/2"	8	6,53	B	0,037	13,27



ACCESORIOS DE COMPRESIÓN

COLLARINES DE TOMA PP

PRODUCTO	CÓDIGO	DIÁMETRO	CAJA	PESO x CAJA kg	VOLUMEN x CAJA m3	PVP 2019 €
 <p>COLLARINES SIN REFUERZO 2 TORNILLOS</p>	ST202020	20x1/2"	150	8,30	0,036	0,74
	ST202520	25x1/2"	90	11,83	0,036	0,91
	ST202525	25x3/4"	90	12,28	0,036	0,91
	ST203220	32x1/2"	90	11,74	0,036	0,97
	ST203225	32x3/4"	90	11,74	0,036	0,97
	ST203232	32x1"	90	11,83	0,036	0,97
	ST204020	40x1/2"	75	10,53	0,036	1,16
	ST204025	40x3/4"	75	11,05	0,036	1,16
	ST204032	40x1"	75	10,53	0,036	1,16
	ST205020	50x1/2"	50	7,80	0,036	1,25
	ST205025	50x3/4"	50	8,05	0,036	1,25
	ST205032	50x1"	50	8,30	0,036	1,25
	ST205040	50x1 1/4"	50	8,30	0,036	1,25
	 <p>COLLARINES SIN REFUERZO 4 TORNILLOS</p>	ST206320	63x1/2"	35	9,98	0,036
ST206325		63x3/4"	35	10,05	0,036	1,74
ST206332		63x1"	35	10,40	0,036	1,74
ST206340		63x1 1/4"	35	10,12	0,036	1,74
ST206350		63x1 1/2"	35	8,75	0,036	1,74
ST207520		75x1/2"	30	9,91	0,036	2,61
ST207525		75x3/4"	30	10,21	0,036	2,61
ST207532		75x1"	30	10,33	0,036	2,61
ST207540		75x1 1/4"	30	10,45	0,036	2,61
ST207550		75x1 1/2"	30	10,51	0,036	2,61
ST207563		75x2"	30	10,33	0,036	2,67
ST209020		90x1/2"	22	8,96	0,036	3,12
ST209025		90x3/4"	22	8,96	0,036	3,12
ST209032		90x1"	22	8,96	0,036	3,12
ST209040		90x1 1/4"	22	8,96	0,036	3,12
ST209050		90x1 1/2"	22	8,96	0,036	3,12
ST209063		90x2"	22	9,33	0,036	3,12
ST201120		110x1/2"	15	8,20	0,036	3,52
ST201125		110x3/4"	15	8,20	0,036	3,52
ST201132		110x1"	15	8,04	0,036	3,52
ST201140		110x1 1/4"	15	8,20	0,036	3,52
ST201150		110x1 1/2"	15	8,20	0,036	3,52
ST201163		110x2"	15	8,43	0,036	3,52
ST201175		110x2 1/2"	35	18,40	0,096	3,52
ST201190		110x3"	25	22,85	0,096	5,54
ST201220		125x1/2"	10	8,00	0,037	5,69
ST201225		125x3/4"	35	17,81	0,096	5,69
ST201232		125x1"	35	17,32	0,096	5,69
ST201240		125x1 1/4"	35	18,23	0,096	5,69
ST201250		125x1 1/2"	35	18,23	0,096	5,69
ST201263		125x2"	35	18,05	0,096	5,69
ST201290		125x3"	6	8,00	0,037	7,01
ST201211		125x4"	6	8,00	0,037	7,63
 <p>COLLARINES SIN REFUERZO 6 TORNILLOS</p>		ST201425	140x3/4"	25	21,73	0,096
	ST201432	140x1"	25	21,65	0,096	8,43
	ST201440	140x1 1/4"	25	21,65	0,096	8,43
	ST201450	140x1 1/2"	25	21,65	0,096	8,43
	ST201463	140x2"	15	23,23	0,072	8,43
	ST201490	140x3"	15	14,29	0,072	9,75
	ST201620	160x1/2"	18	16,74	0,072	12,06
	ST201625	160x3/4"	18	16,76	0,072	12,06
	ST201632	160x1"	18	16,87	0,072	12,06
	ST201640	160x1 1/4"	18	16,92	0,072	12,06
	ST201650	160x1 1/2"	18	16,92	0,072	12,06
	ST201663	160x2"	18	16,92	0,072	12,06
	ST201690	160x3"	15	14,92	0,072	14,01
	ST201611	160x4"	15	15,84	0,072	14,01
	ST202025	200x3/4"	10	21,95	0,072	38,72
	ST202032	200x1"	10	21,60	0,072	38,72
	ST202040	200x1 1/4"	10	22,65	0,072	38,72
	ST202050	200x1 1/2"	10	17,58	0,072	38,72
	ST202063	200x2"	8	17,88	0,072	38,72
	ST202090	200x3"	8	17,94	0,072	38,72
	ST202011	200x4"	8	17,94	0,072	38,72
	ST202220	225x1/2"	6	14,26	0,072	45,01
	ST202232	225x1"	6	14,28	0,072	45,01
	ST202240	225x1 1/4"	6	14,48	0,072	45,01
	ST202250	225x1 1/2"	6	14,67	0,072	45,01
	ST202263	225x2"	6	14,62	0,072	45,01
	ST202290	225x3"	6	14,62	0,072	45,01
	ST202211	225x4"	4	12,15	0,072	45,01
	ST202332	250x1"	4	12,15	0,072	53,34
	ST202340	250x1 1/4"	4	12,15	0,072	53,34
	ST202350	250x1 1/2"	4	12,15	0,072	53,34
	ST202363	250x2"	4	12,30	0,072	53,34
	ST202390	250x3"	4	12,36	0,072	53,34
	ST202311	250x4"	4	12,36	0,072	53,34
	ST203032	315x1"	3	13,32	0,072	64,52
	ST203040	315x1 1/4"	3	13,33	0,072	64,52
	ST203050	315x1 1/2"	3	13,33	0,072	64,52
	ST203063	315x2"	3	13,45	0,072	64,52
	ST203090	315x3"	3	13,50	0,072	64,52
	ST203011	315x4"	3	13,68	0,072	64,52

ACCESORIOS DE COMPRESIÓN

COLLARINES DE TOMA PP

PRODUCTO	CÓDIGO	DIÁMETRO	CAJA	PESO x CAJA kg	VOLUMEN x CAJA m3	PVP 2019 €	
 <p>COLLARINES CON REFUERZO 2 TORNILLOS</p>	ST212020	20x1/2"	175	11,55	0,036	1,69	
	ST212520	25x1/2"	90	11,70	0,036	1,69	
	ST212525	25x3/4"	90	12,60	0,036	1,69	
	ST213220	32x1/2"	90	11,70	0,036	1,82	
	ST213225	32x3/4"	90	12,60	0,036	1,82	
	ST213232	32x1"	100	12,00	0,036	1,82	
	ST214020	40x1/2"	75	10,50	0,036	1,99	
	ST214025	40x3/4"	75	10,50	0,036	1,99	
	ST214032	40x1"	70	9,10	0,036	2,16	
	ST215020	50x1/2"	50	7,50	0,036	2,16	
	ST215025	50x3/4"	50	8,00	0,036	2,16	
	ST215032	50x1"	50	8,50	0,036	2,16	
	 <p>COLLARINES CON REFUERZO 4 TORNILLOS</p>	ST216320	63x1/2"	35	9,45	0,036	2,80
		ST216325	63x3/4"	35	9,80	0,036	2,80
ST216332		63x1	35	10,15	0,036	2,80	
ST216340		63x1 1/4"	35	9,80	0,036	2,80	
ST216350		63x1 1/2"	35	9,10	0,036	2,80	
ST217520		75x1/2"	30	9,60	0,036	3,18	
ST217525		75x3/4"	30	9,90	0,036	3,18	
ST217532		75x1"	30	10,20	0,036	3,18	
ST217540		75x1 1/4"	30	10,20	0,036	3,18	
ST217550		75x1 1/2"	30	11,70	0,036	3,18	
ST217563		75x2"	20	6,00	0,036	3,18	
ST219020		90x1/2"	22	8,36	0,036	4,21	
ST219025		90x3/4"	22	8,36	0,036	4,21	
ST219032		90x1"	22	8,58	0,036	4,21	
ST219040		90x1 1/4"	22	8,36	0,036	4,21	
ST219050		90x1 1/2"	22	8,58	0,036	4,21	
ST219063		90x2"	22	8,58	0,036	4,21	
ST211120		110x1/2"	15	7,35	0,036	5,25	
ST211125		110x3/4"	15	7,50	0,036	5,25	
ST211132		110x1"	15	7,50	0,036	5,25	
ST211140		110x1 1/4"	15	7,65	0,036	5,25	
ST211150		110x1 1/2"	15	7,65	0,036	5,25	
ST211163		110x2"	15	8,10	0,036	5,25	
ST211175		110x2 1/2"	35	19,49	0,096	5,25	
ST211190		110x3"	25	26,30	0,096	7,32	
ST211220		125x1/2"	35	18,23	0,096	7,49	
ST211225		125x3/4"	35	17,81	0,096	7,49	
ST211232		125x1"	35	18,79	0,096	7,49	
ST211240		125x1 1/4"	35	18,86	0,096	7,49	
ST211250		125x1 1/2"	35	19,07	0,096	7,49	
ST211263		125x2"	35	23,85	0,096	7,49	
ST211290		125x3"	6	7,98	0,037	8,71	
ST211211		125x4"	6	8,00	0,037	8,71	
 <p>COLLARINES CON REFUERZO 6 TORNILLOS</p>	ST211425	140x3/4"	25	23,85	0,096	10,75	
	ST211432	140x1"	25	23,85	0,096	10,75	
	ST211440	140x1 1/4"	25	23,78	0,096	10,75	
	ST211450	140x1 1/2"	25	23,80	0,096	10,75	
	ST211463	140x2"	20	27,40	0,072	10,75	
	ST211490	140x3"	20	27,80	0,072	11,62	
	ST211620	160x1/2"	18	26,10	0,072	12,93	
	ST211625	160x3/4"	18	25,56	0,072	12,93	
	ST211632	160x1"	18	22,82	0,072	12,93	
	ST211640	160x1 1/4"	18	23,69	0,072	12,93	
	ST211650	160x1 1/2"	18	24,12	0,072	12,93	
	ST211663	160x2"	18	24,55	0,072	12,93	
	ST211690	160x3"	15	27,60	0,072	16,67	
	ST211611	160x4"	15	23,02	0,072	16,67	
	ST212025	200x3/4"	10	22,66	0,072	45,08	
	ST212032	200x1"	10	23,32	0,072	45,08	
	ST212040	200x1 1/4"	10	22,96	0,072	45,08	
	ST212050	200x1 1/2"	10	23,20	0,072	45,08	
	ST212063	200x2"	8	21,30	0,072	45,08	
	ST212090	200x3"	6	19,72	0,072	45,08	
	ST212011	200x4"	6	20,08	0,072	43,00	
	ST212220	225x1/2"	6	20,12	0,072	65,18	
	ST212225	225x3/4"	6	20,56	0,072	65,18	
	ST212232	225x1"	6	20,48	0,072	65,18	
	ST212240	225x1 1/4"	6	21,76	0,072	65,18	
	ST212250	225x1 1/2"	6	19,49	0,072	65,18	
	ST212263	225x2"	6	26,30	0,072	65,18	
	ST212290	225x3"	6	18,23	0,072	67,62	
	ST212211	225x4"	6	17,81	0,072	67,62	
	ST212320	250x1/2"	4	18,79	0,072	74,02	
	ST212332	250x1"	4	18,86	0,072	77,05	
	ST212340	250x1 1/4"	4	19,07	0,072	77,05	
	ST212350	250x1 1/2"	4	23,85	0,072	77,05	
	ST212363	250x2"	4	23,85	0,072	77,05	
	ST212390	250x3"	4	23,85	0,072	78,58	
	ST212311	250x4"	4	23,78	0,072	78,58	
	ST213032	315x1"	3	23,80	0,072	92,09	
	ST213040	315x1 1/4"	3	13,50	0,072	92,09	
	ST213050	315x1 1/2"	3	13,38	0,072	92,09	
	ST213063	315x2"	3	13,54	0,072	92,09	
	ST213090	315x3"	3	13,62	0,072	95,30	
	ST213011	315x4"	3	13,84	0,072	95,30	

ACCESORIOS DE COMPRESIÓN



VALVULAS Y ACCESORIOS PP ROSCADAS

PRODUCTO	CÓDIGO	DIÁMETRO	CAJA	PESO x CAJA kg	TIPO	VOLUMEN x CAJA m3	PVP 2019 €
 VALVULA PRESION PPB H	ST141020PPB	1/2"	65	15,16	B	0,037	3,12
	ST141025PPB	3/4"	30	10,20	B	0,037	4,70
	ST141032PPB	1"	25	6,10	B	0,037	4,87
	ST141040PPB	1 1/4"	12	7,20	B	0,037	7,20
	ST141050PPB	1 1/2"	12	8,80	B	0,037	7,49
	ST141063PPB	2"	5	4,50	B	0,037	12,38
	 VALVULA PRESION PPB M	ST142020PPB	1/2"	65	15,16	B	0,037
ST142025PPB		3/4"	30	10,20	B	0,037	6,29
ST142032PPB		1"	25	6,40	B	0,037	6,34
ST142040PPB		1 1/4"	12	7,20	B	0,037	8,63
ST142050PPB		1 1/2"	12	8,80	B	0,037	9,01
ST142063PPB		2"	5	4,50	B	0,037	13,89
 VALVULA PRESION PPB H/M		ST142020FMPPB	1/2"	65	15,16	B	0,037
	ST142025FMPPB	3/4"	30	10,20	B	0,037	10,41
	ST142032FMPPB	1"	25	6,40	B	0,037	10,75
	ST142040FMPPB	1 1/4"	12	7,20	B	0,037	16,75
	ST142050FMPPB	1 1/2"	12	8,80	B	0,037	17,07
	ST142063FMPPB	2"	5	4,50	B	0,037	27,91
	 VALVULA PRESION UNIBLOCK PPB H	ST146020PPB	1/2"	100	7,90	B	0,037
ST146025PPB		3/4"	40	7,80	B	0,037	5,92
ST146032PPB		1"	40	7,50	B	0,037	6,05
ST146040PPB		1 1/4"	15	9,00	B	0,037	11,23
ST146050PPB		1 1/2"	15	10,50	B	0,037	11,66
ST146063PPB		2"	8	7,20	B	0,037	18,48
 VALVULA PRESION UNIBLOCK PPB M		ST147020PPB	1/2"	100	7,90	B	0,037
	ST147025PPB	3/4"	40	7,80	B	0,037	4,11
	ST147032PPB	1"	40	7,50	B	0,037	4,25
	ST147040PPB	1 1/4"	15	9,00	B	0,037	11,45
	ST147050PPB	1 1/2"	15	10,50	B	0,037	11,63
	ST147063PPB	2"	8	7,20	B	0,037	19,56
	 VALVULA PRESION UNIBLOCK PPB M/H	ST146020MPPB	1/2"	100	7,90	B	0,037
ST146025MPPB		3/4"	40	7,80	B	0,037	4,80
ST146032MPPB		1"	40	7,50	B	0,037	4,84
ST146040MPPB		1 1/4"	15	9,00	B	0,037	9,39
ST146050MPPB		1 1/2"	15	10,50	B	0,037	9,56
ST146063MPPB		2"	8	7,20	B	0,037	14,88
 VALVULA PRESION UNIBLOCK PPB H/M		ST147020FPPB	1/2"	100	7,90	B	0,037
	ST147025FPPB	3/4"	40	7,80	B	0,037	4,64
	ST147032FPPB	1"	40	7,50	B	0,037	4,72
	ST147040FPPB	1 1/4"	15	9,00	B	0,037	9,23
	ST147050FPPB	1 1/2"	15	10,50	B	0,037	9,36
	ST147063FPPB	2"	8	7,20	B	0,037	14,36

ACCESORIOS DE COMPRESIÓN





VALVULAS Y ACCESORIOS PP ROSCADAS

PRODUCTO	CÓDIGO	DIÁMETRO	CAJA	PESO x CAJA kg	TIPO	VOLUMEN x CAJA m3	PVP 2019 €
 PPGF VALV. BOLA LATON CHROM. H/H	ST740020	1/2"	80			0,018	4,57
	ST740025	3/4"	40			0,018	5,58
	ST740032	1"	35			0,018	6,93
	ST740040	1 1/4"	25			0,018	12,79
	ST740050	1 1/2"	10			0,018	17,52
	ST740063	2"	7			0,018	21,07
	ST740075	2 1/2"	5			0,036	42,66
	ST740090	3"	3			0,036	65,87
ST740110	4"	1			0,072	106,65	

 PPGF VALV. BOLA LATON CHROM. M/F	ST741020	1/2"	80			0,018	5,34
	ST741025	3/4"	40			0,018	8,00
	ST741032	1"	35			0,018	9,06
	ST741040	1 1/4"	25			0,018	14,40
	ST741050	1 1/2"	10			0,018	20,82
	ST741063	2"	7			0,018	33,34







VALVULAS Y ACCESORIOS PP ROSCADAS

PRODUCTO	CÓDIGO	DIÁMETRO	CAJA	PESO x CAJA kg	TIPO	VOLUMEN x CAJA m3	PVP 2019 €
 MACHON	ST750001	1/2"x1/2"	100	0,86		0,003	0,11
	ST750002	3/4"x3/4"	100	1,19		0,005	0,13
	ST750003	1"x1"	50	0,96		0,004	0,19
	ST750004	1 1/4"x1 1/4"	50	1,79		0,008	0,33
	ST750005	1 1/2"x1 1/2"	20	0,80		0,004	0,39
	ST750006	2"x2"	10	0,68		0,004	0,70
	ST750007	2 1/2"x2 1/2"	5	0,55		0,003	1,35
	ST750008	3"x3"	5	1,52		0,005	1,75
	ST750009	4"x4"	5			0,008	3,17
 MACHON REDUCIDO	ST751001	3/4"x1/2"	100	1,00		0,004	0,12
	ST751002	1"x3/4"	100	1,81		0,008	0,16
	ST751003	1 1/4"x1"	50	1,53		0,008	0,29
	ST751004	1 1/2"x1 1/4"	20	0,80		0,004	0,39
	ST751005	2"x1 1/2"	10	0,65		0,003	0,67
	ST751006	2 1/2"x2"	5	0,51		0,003	2,07
	ST751007	3"x2 1/2"	5	1,13		0,005	2,31
	ST751008	2"x1 1/2"	10	0,65		0,003	0,67
	ST751009	4"x2 1/2"	5			0,008	4,76
	ST751010	4"x3"	5			0,008	4,75
	ST751011	3"x2"	5	0,82		0,005	3,03
	ST751012	1"x1/2"	100	1,38		0,006	0,16
	ST751013	1 1/4"x1/2"	50			0,006	0,34
	ST751014	1 1/4"x3/4"	50			0,006	0,34
	ST751015	1 1/2"x1/2"	20			0,003	0,39
	ST751016	1 1/2"x3/4"	20			0,003	0,39
	ST751017	1 1/2"x1"	20			0,004	0,39
	ST751018	2"x3/4"	10	0,54		0,003	0,67
ST751019	2"x1"	10	0,55		0,003	0,67	
ST751020	2"x1 1/4"	10	0,60		0,003	0,67	
 TAPON MACHO	ST752001	1/2"	100	0,48		0,002	0,14
	ST752002	3/4"	100	0,90		0,003	0,16
	ST752003	1"	50	0,78		0,003	0,21
	ST752004	1 1/4"	50	1,33		0,005	0,34
	ST752005	1 1/2"	20	1,23		0,003	0,41
	ST752006	2"	10	0,54		0,002	0,61
	ST752007	2 1/2"	5	0,58		0,002	1,19
	ST752008	3"	5	0,67		0,003	1,56
	ST752009	4"	5			0,006	4,32

ACCESORIOS DE COMPRESIÓN





VALVULAS Y ACCESORIOS PP ROSCADAS

PRODUCTO	CÓDIGO	DIÁMETRO	CAJA	PESO x CAJA kg	TIPO	VOLUMEN x CAJA m3	PVP 2019 €
 TAPON HEMBRA	ST753001	1/2"	100	0,48		0,002	0,10
	ST753002	3/4"	100	0,83		0,003	0,14
	ST753003	1"	50	0,60		0,003	0,15
	ST753004	1 1/4"	50	0,82		0,005	0,26
	ST753005	1 1/2"	20	0,68		0,003	0,59
	ST753006	2"	10	0,50		0,003	0,71
	ST753007	2 1/2"	5			0,002	2,74
	ST753008	3"	5			0,004	3,73
	ST753009	4"	5			0,005	6,19
 MANGUITO	ST754001	1/2"x1/2"	100	1,46		0,005	0,25
	ST754002	3/4"x3/4"	100	2,17		0,009	0,27
	ST754003	1"x1"	50	1,74		0,008	0,36
	ST754004	1 1/4"x1 1/4"	50	3,00		0,013	0,96
	ST754005	1 1/2"x1 1/2"	20	1,48		0,006	1,24
	ST754006	2"x2"	10	1,15		0,006	1,67
	ST754007	2 1/2"x2 1/2"	5	1,10		0,005	5,08
	ST754008	3"x3"	5	1,50		0,006	6,11
	ST754009	4"x4"	5			0,011	12,06
 MANGUITO REDUCIDO	ST755001	3/4"x1/2"	100	2,01		0,008	0,28
	ST755002	1"x3/4"	100	1,58		0,013	0,36
	ST755003	1 1/4"x1"	50	1,83		0,013	0,79
	ST755004	1 1/2"x1 1/4"	20	1,40		0,006	1,21
	ST755005	2"x1 1/2"	10	0,94		0,005	1,59
	ST755006	2 1/2"x2"	5	0,88		0,004	4,76
	ST755007	3"x2 1/2"	5	1,17		0,005	6,19
	ST755008	4"x2 1/2"	5			0,008	18,98
	ST755009	4"x3"	5			0,008	12,07
 REDUCCION M/H	ST756001	1/2"x3/8"	100	1,09		0,005	0,34
	ST756002	3/4"x1/2"	100	1,16		0,005	0,37
	ST756003	1"x1/2"	50	1,00		0,005	0,40
	ST756004	1"x3/4"	50	1,00		0,005	0,40
	ST756005	1 1/4"x3/4"	50	0,89		0,008	0,57
	ST756006	1 1/4"x1"	50	1,06		0,011	0,60
	ST756007	1 1/2"x1 1/4"	20	1,38		0,005	0,72
	ST756008	2"x1 1/2"	10	0,68		0,004	1,01
 TE IGUAL H	ST759001	1/2"	50	1,55		0,006	0,67
	ST759002	3/4"	50	2,05		0,011	0,76
	ST759003	1"	25	1,69		0,008	0,92
	ST759004	1 1/4"	10	1,28		0,006	1,59
	ST759005	1 1/2"	10	1,71		0,008	2,94
	ST759006	2"	10	0,97		0,016	4,21
	ST759007	2 1/2"	5			0,013	10,71
	ST759008	3"	5			0,020	15,71
 TUERCA REDUCIDA M/H	ST757001	3/4"x1/2"	100	0,70		0,003	0,25
	ST757002	1"x1/2"	50	0,72		0,003	0,27
	ST757003	1"x3/4"	50	0,64		0,003	0,27
	ST757004	1 1/4"x1/2"	50	1,08		0,005	0,45
	ST757005	1 1/4"x3/4"	50	1,29		0,005	0,45
	ST757006	1 1/4"x1"	50	1,12		0,005	0,45
	ST757007	1 1/2"x3/4"	20	0,72		0,002	0,57
	ST757008	1 1/2"x1"	20	0,62		0,002	0,57
	ST757009	1 1/2"x1 1/4"	20	0,46		0,002	0,57
	ST757010	2"x3/4"	10	0,53		0,002	1,11
	ST757011	2"x1"	10	0,52		0,002	1,11
	ST757012	2"x1 1/4"	10	0,50		0,002	1,11
	ST757013	2"x1 1/2"	10	0,40		0,002	1,30
	ST757014	2 1/2"x2"	5	0,42		0,002	2,19
	ST757015	3"x2"	5	0,72		0,003	3,02
	ST757016	3"x2 1/2"	5	0,50		0,003	3,02
	ST757017	4"x3"	5			0,003	5,17

ACCESORIOS DE COMPRESIÓN



VALVULAS Y ACCESORIOS PP ROSCADAS

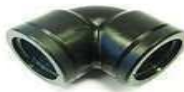



PRODUCTO	CÓDIGO	DIÁMETRO	CAJA	PESO x CAJA kg	TIPO	VOLUMEN x CAJA m3	PVP 2019 €
 <p>CURVA 90° M/H</p>	ST758001	1/2"x1/2"	100	1,81		0,008	0,34
	ST758002	3/4"x3/4"	50	1,40		0,006	0,42
	ST758003	1"x1"	50	1,18		0,011	0,52
 <p>TUERCA REDUCIDA H/M</p>	ST760001	3/4"x1/2"	100	1,75		0,008	0,53
	ST760002	1"x1/2"	50	1,40		0,006	0,63
	ST760003	1"x3/4"	50	1,50		0,006	0,63
	ST760004	1 1/4"x1/2"	25	1,17		0,005	0,87
	ST760005	1 1/4"x3/4"	25	1,26		0,005	0,88
	ST760006	1 1/4"x1"	25	1,31		0,005	0,90
	ST760007	1 1/2"x1/2"	10	0,58		0,002	0,90
	ST760008	1 1/2"x3/4"	20	1,23		0,005	0,96
	ST760009	1 1/2"x1"	20	1,25		0,005	0,96
	ST760010	1 1/2"x1 1/4"	20	1,25		0,005	1,24
	ST760011	2"x3/4"	10	0,90		0,005	1,24
	ST760012	2"x1"	10	0,87		0,004	1,28
	ST760013	2"x1 1/4"	10	0,93		0,004	1,32
	ST760014	2"x1 1/2"	10	0,97		0,006	1,35
 <p>CURVA 90° H/H</p>	ST761001	1/2"x1/2"	100	1,70		0,008	0,47
	ST761002	3/4"x3/4"	100	1,75		0,013	0,56
	ST761003	1"x1"	50	2,24		0,011	0,68
	ST761004	1 1/4"x1 1/4"	10	0,81		0,004	1,22
	ST761005	1 1/2"x1 1/2"	10	1,33		0,005	2,31
	ST761006	2"x2"	10	2,07		0,009	3,17
	ST761007	2 1/2"x2 1/2"	5	3,50		0,009	7,14
	ST761008	3"x3"	5	3,80		0,018	10,31

ACCESORIOS DE COMPRESIÓN



HERRAMIENTAS Y RECAMBIOS



PRODUCTO	CÓDIGO	DIÁMETRO	CAJA	PESO x CAJA kg	TIPO	VOLUMEN x CAJA m3	PVP 2019 €
 GOMA TRANSICION CU,FE,PVC	ST000715	Ø15-16 (1/2")	100	3,60		0,007	0,65
	ST000721	Ø21-22 (3/4")	75	3,60		0,007	0,88
 GOMA MULTICAPA	ST000716		16				0,31
	ST000720		20				0,45
 BICONO DE CPVC	ST000120PVC	20					0,12
	ST000125PVC	25					0,10
	ST000132PVC	32					0,11
	ST000140PVC	40					0,31
	ST000150PVC	50					0,47
	ST000163PVC	63					0,89
	ST000175PVC	75					1,11
	ST000190PVC	90					1,23
ST000110PVC	110					2,65	
PRODUCTO	CÓDIGO	DIÁMETRO	CAJA	PESO x CAJA kg	TIPO	VOLUMEN x CAJA m3	PVP 2019 €
 LLAVES	ST776001	16-32	50	5,36	C	0,019	1,32
	ST776002	40-63	50	9,33	B	0,037	1,65
	ST776003	16-63	50	9,11	B	0,037	1,92
	ST776004	40-63	1	1,15			63,68
	ST776005	75-110	1	1,50			75,54
 AFILADOR PARA TUBOS	ST776098	16-63	1	0,15			21,04

ACCESORIOS DE COMPRESIÓN
ACCESORIOS DE COMPRESIÓN DE LATÓN PARA PE (AXO)

PRODUCTO	CODIGO	DIAMETRO	PVP 2019 €
ACCESORIO DE LATÓN ARO METALICO			
 ACOPLAMIENTO	AC312001	20mm x 20mm	6,58
	AC312002	25mm x 25mm	7,74
	AC312003	32mm x 32mm	11,06
	AC312004	40mm x 40mm	17,59
	AC312005	50mm x 50mm	26,42
	AC312006	63mm x 63mm	39,67
	AC312221	75mm x 75mm	108,86
	AC312222	90mm x 90mm	157,91
	AC312223	110mm x 110mm	349,67
 ENLACE MACHO	AC312011	20mm x 1/2"	3,76
	AC312012	25mm x 1/2"	4,48
	AC312013	25mm x 3/4"	4,60
	AC312014	32mm x 3/4"	5,85
	AC312015	32mm x 1"	6,90
	AC312016	40mm x 1"	11,07
	AC312017	40mm x 1 1/4"	11,07
	AC312018	50mm x 1 1/2"	16,64
	AC312019	63mm x 2"	25,80
	AC312224	75mm x 2"	67,25
	AC312225	75mm x 2 1/2"	142,82
	AC312226	90mm x 2 1/2"	94,95
	AC312227	90mm x 3"	92,83
	AC312228	110mm x 4"	187,66
 ENLACE HEMBRA	AC312021	25mm x 1/2"	4,96
	AC312022	25mm x 3/4"	4,96
	AC312023	32mm x 3/4"	6,77
	AC312024	32mm x 1"	7,20
	AC312025	40mm x 1"	10,98
	AC312026	40mm x 1 1/4"	11,14
	AC312027	50mm x 1 1/2"	17,12
	AC312028	63mm x 2"	27,49
	AC312229	75mm x 2 1/2"	141,23
	AC312230	90mm x 3"	91,45
	AC312231	110mm x 4"	188,28
	 TAPÓN	AC312029	20mm
AC312030		25mm	4,96
AC312031		32mm	7,20
AC312032		40mm	35,65
AC312033		50mm	36,19
AC312034		63mm	53,95
 CODO 90 PE-PE	AC312041	20mm x 20mm	7,31
	AC312042	25mm x 25mm	9,79
	AC312043	32mm x 32mm	14,36
	AC312044	40mm x 40mm	21,84
	AC312045	50mm x 50mm	31,75
	AC312046	63mm x 63mm	53,79
	AC312232	75mm x 75mm	134,80
	AC312233	90mm x 90mm	258,22
 CODO 90 PE-MACHO	AC312047	20mm x 1/2"	5,04
	AC312048	25mm x 3/4"	6,63
	AC312049	32mm x 1"	9,76
	AC312050	40mm x 1 1/4"	15,80
	AC312051	50mm x 1 1/2"	24,00
	AC312052	63mm x 2"	43,87
	AC312234	75mm x 2 1/2"	97,80
	AC312235	90mm x 3"	195,40
 CODO 90 PE-HEMBRA	AC312053	20mm x 1/2"	5,04
	AC312054	25mm x 3/4"	6,63
	AC312055	32mm x 1"	9,79
	AC312056	40mm x 1 1/4"	15,80
	AC312057	50mm x 1 1/2"	22,52
	AC312058	63mm x 2"	41,23
	AC312236	75mm x 2 1/2"	94,53
	AC312237	90mm x 3"	195,40
 TE IGUAL	AC312071	20mm x 20mm x 20mm	10,32
	AC312072	25mm x 25mm x 25mm	13,25
	AC312073	32mm x 32mm x 32mm	19,87
	AC312074	40mm x 40mm x 40mm	30,45
	AC312075	50mm x 50mm x 50mm	44,91
	AC312076	63mm x 63mm x 63mm	74,95
	AC312238	75mm x 75mm x 75mm	194,95
	AC312239	90mm x 90mm x 90mm	286,39
	 TE PE-HEMBRA	AC312077	20mm x 1/2" x 20mm
AC312078		25mm x 3/4" x 25mm	11,66
AC312079		32mm x 1" x 32mm	15,50
AC312080		40mm x 1 1/4" x 40mm	23,53
AC312081		50mm x 1 1/2" x 50mm	37,69
AC312082		63mm x 2" x 63mm	60,15
AC312241		75mm x 2" x 75mm	146,85
AC312242		90mm x 2 1/2" x 90mm	217,72

ACCESORIOS DE COMPRESIÓN DE LATÓN PARA PE (AXO)

PRODUCTO	CODIGO	DIAMETRO	PVP 2019 €
ACCESORIO DE LATÓN ARO PLÁSTICO			
	AC312111	20mm x 20mm	5,28
	AC312112	25mm x 25mm	7,06
	AC312113	32mm x 32mm	10,08
	AC312114	40mm x 40mm	16,04
	AC312115	50mm x 50mm	21,85
	AC312116	63mm x 63mm	33,37
	AC312121	20mm x 1/2"	3,42
	AC312122	25mm x 1/2"	3,59
	AC312123	25mm x 3/4"	4,20
	AC312124	32mm x 3/4"	5,76
	AC312125	32mm x 1"	6,25
	AC312126	40mm x 1"	7,93
	AC312127	40mm x 1 1/4"	9,82
	AC312128	50mm x 1 1/2"	15,20
	AC312129	63mm x 2"	23,36
		AC312133	20mm x 1/2"
AC312134		25mm x 1/2"	3,59
AC312135		25mm x 3/4"	4,38
AC312136		32mm x 3/4"	5,42
AC312137		32mm x 1"	6,51
AC312138		40mm x 1"	9,93
AC312139		40mm x 1 1/4"	9,93
AC312140		50mm x 1 1/2"	15,52
AC312141		63mm x 2"	24,21
	AC312161	20mm x 20mm	6,63
	AC312162	25mm x 25mm	8,88
	AC312163	32mm x 32mm	13,08
	AC312164	40mm x 40mm	19,87
	AC312165	50mm x 50mm	28,84
	AC312166	63mm x 63mm	43,92
	AC312167	20mm x 1/2"	4,48
	AC312168	25mm x 3/4"	5,98
	AC312169	32mm x 1"	8,88
	AC312170	40mm x 1 1/4"	14,36
	AC312171	50mm x 1 1/2"	21,03
	AC312172	63mm x 2"	38,10
	AC312173	20mm x 1/2"	4,51
	AC312174	25mm x 3/4"	5,98
	AC312175	32mm x 1"	8,91
	AC312176	40mm x 1 1/4"	14,36
	AC312177	50mm x 1 1/2"	21,03
	AC312178	63mm x 2"	34,33
	AC312191	20mm x 20mm x 20mm	9,32
	AC312192	25mm x 25mm x 25mm	12,10
	AC312193	32mm x 32mm x 32mm	18,06
	AC312194	40mm x 40mm x 40mm	27,44
	AC312195	50mm x 50mm x 50mm	40,96
	AC312196	63mm x 63mm x 63mm	68,18
	AC312197	20mm x 1/2" x 20mm	7,27
	AC312198	25mm x 3/4" x 25mm	9,31
	AC312199	32mm x 1" x 32mm	14,05
	AC312200	40mm x 1 1/4" x 40mm	21,35
	AC312201	50mm x 1 1/2" x 50mm	34,28
	AC312202	63mm x 2" x 63mm	54,59

ABRAZADERAS DE REPARACIÓN



ABRAZADERAS DE REPARACION EN INOXIDABLE Y JUNTA EPDM



PRODUCTO	CODIGO	DESCRIPCION	PVP 2019 €
----------	--------	-------------	------------



MODELOS KITS DE REPARACION		
TS5103201	KIT EMSA STA-BOX EPDM S (cobertura de 60 a 170 mm)	516,49 €
TS5103301	KIT EMSA STA-BOX EPDM L (cobertura de 48 a 359 mm)	2.250,60 €
TS51033011	EMSA L SECTION 1 EPDM	90,54 €
TS51033012	EMSA L SECTION 2 EPDM	91,78 €
TS51033013	EMSA L SECTION 3 EPDM	89,60 €
TS51033014	EMSA L SECTION 4 EPDM	90,78 €
TS51033015	EMSA L SECTION 5 EPDM	98,84 €
TS51033016	EMSA L SECTION 6 EPDM	101,44 €
TS51033017	EMSA L SECTION 7 EPDM	104,04 €
TS51033018	EMSA L SECTION 8 EPDM	111,61 €
TS5103401	KIT EMSA STA-BOX EPDM XL (cobertura de 213 a 669 mm)	960,65 €
TS5103401A	EMSA XL SECTION A EPDM	126,35 €
TS5103401B	EMSA XL SECTION B EPDM	138,74 €
TS5103401C	EMSA XL SECTION C EPDM	148,16 €
TS5103401D	EMSA XL SECTION D EPDM	163,92 €
TS5103401E	EMSA XL SECTION E EPDM	180,84 €



TZ510302002315	STA. TS10 20- 23 L= 150 EPDM	30,87 €
TZ510302002320	STA. TS10 20- 23 L= 200 EPDM	37,19 €
TZ510302002325	STA. TS10 20- 23 L= 250 EPDM	49,45 €
TZ510302502815	STA. TS10 25- 28 L= 150 EPDM	30,87 €
TZ510302502820	STA. TS10 25- 28 L= 200 EPDM	37,19 €
TZ510302502825	STA. TS10 25- 28 L= 250 EPDM	49,45 €
TZ510303203615	STA. TS10 32- 36 L= 150 EPDM	30,87 €
TZ510303203620	STA. TS10 32- 36 L= 200 EPDM	37,19 €
TZ510303203625	STA. TS10 32- 36 L= 250 EPDM	49,45 €
TZ510303604220	STA. TS10 36- 42 L= 200 EPDM	42,56 €
TZ510304004415	STA. TS10 40- 44 L= 150 EPDM	30,87 €
TZ510304004420	STA. TS10 40- 44 L= 200 EPDM	37,19 €
TZ510304004425	STA. TS10 40- 44 L= 250 EPDM	49,45 €
TZ510304405120	STA. TS10 44- 51 L= 200 EPDM	45,89 €
TZ510304805515	STA. TS10 48- 55 L= 150 EPDM	32,28 €
TZ510304805520	STA. TS10 48- 55 L= 200 EPDM	38,88 €
TZ510304805525	STA. TS10 48- 55 L= 250 EPDM	51,67 €
TZ510305005715	STA. TS10 50- 57 L= 150 EPDM	37,72 €
TZ510305205915	STA. TS10 52- 59 L= 150 EPDM	33,63 €
TZ510305205920	STA. TS10 52- 59 L= 200 EPDM	40,57 €
TZ510305205925	STA. TS10 52- 59 L= 250 EPDM	53,96 €
TZ510305205930	STA. TS10 52- 59 L= 300 EPDM	60,85 €
TZ510305706420	STA. TS10 57- 64 L= 200 EPDM	41,84 €
TZ510305806520	STA. TS10 58- 65 L= 200 EPDM	41,93 €
TZ510306006715	STA. TS10 60- 67 L= 150 EPDM	35,07 €
TZ510306006720	STA. TS10 60- 67 L= 200 EPDM	42,26 €
TZ510306006725	STA. TS10 60- 67 L= 250 EPDM	56,20 €
TZ510306006730	STA. TS10 60- 67 L= 300 EPDM	62,12 €
TZ510306307015	STA. TS10 63- 70 L= 150 EPDM	35,79 €
TZ510306307020	STA. TS10 63- 70 L= 200 EPDM	41,17 €
TZ510306707415	STA. TS10 67- 74 L= 150 EPDM	36,48 €
TZ510306707420	STA. TS10 67- 74 L= 200 EPDM	43,94 €
TZ510306707425	STA. TS10 67- 74 L= 250 EPDM	58,46 €
TZ510306707430	STA. TS10 67- 74 L= 300 EPDM	64,60 €
TZ510306707440	STA. TS10 67- 74 L= 400 EPDM	85,25 €
TZ510306807520	STA. TS10 68- 75 L= 200 EPDM	43,95 €
TZ510307007715	STA. TS10 70- 77 L= 150 EPDM	37,42 €
TZ510307007720	STA. TS10 70- 77 L= 200 EPDM	45,08 €
TZ510307007725	STA. TS10 70- 77 L= 250 EPDM	59,95 €
TZ510307007730	STA. TS10 70- 77 L= 300 EPDM	66,25 €
TZ510307007740	STA. TS10 70- 77 L= 400 EPDM	86,54 €
TZ510307308015	STA. TS10 73- 80 L= 150 EPDM	38,36 €
TZ510307308020	STA. TS10 73- 80 L= 200 EPDM	46,21 €
TZ510307308025	STA. TS10 73- 80 L= 250 EPDM	61,44 €
TZ510307308030	STA. TS10 73- 80 L= 300 EPDM	67,91 €
TZ510307308040	STA. TS10 73- 80 L= 400 EPDM	88,70 €
TZ510307508315	STA. TS10 75- 83 L= 150 EPDM	39,28 €
TZ510307508320	STA. TS10 75- 83 L= 200 EPDM	47,32 €
TZ510307508325	STA. TS10 75- 83 L= 250 EPDM	62,93 €
TZ510307508330	STA. TS10 75- 83 L= 300 EPDM	69,57 €
TZ510307508340	STA. TS10 75- 83 L= 400 EPDM	90,86 €
TZ510308209015	STA. TS10 82- 90 L= 150 EPDM	40,21 €
TZ510308209020	STA. TS10 82- 90 L= 200 EPDM	48,47 €
TZ510308209025	STA. TS10 82- 90 L= 250 EPDM	64,45 €
TZ510308209030	STA. TS10 82- 90 L= 300 EPDM	71,23 €
TZ510308209040	STA. TS10 82- 90 L= 400 EPDM	93,04 €
TZ510308609530	STA. TS10 86- 95 L= 300 EPDM	83,42 €
TZ510308709415	STA. TS10 87- 94 L= 150 EPDM	41,15 €
TZ510308709420	STA. TS10 87- 94 L= 200 EPDM	49,58 €
TZ510308709425	STA. TS10 87- 94 L= 250 EPDM	65,95 €
TZ510308709430	STA. TS10 87- 94 L= 300 EPDM	72,89 €
TZ510308709440	STA. TS10 87- 94 L= 400 EPDM	95,21 €
TZ510308709720	STA. TS10 87- 97 L= 200 EPDM	58,52 €
TZ510308809820	STA. TS10 88- 98 L= 200 EPDM	50,70 €



TZ510309009815	STA. TS10	90- 98 L= 150	EPDM	42,09 €
TZ510309009820	STA. TS10	90- 98 L= 200	EPDM	50,70 €
TZ510309009825	STA. TS10	90- 98 L= 250	EPDM	67,46 €
TZ510309009830	STA. TS10	90- 98 L= 300	EPDM	74,55 €
TZ510309009840	STA. TS10	90- 98 L= 400	EPDM	97,35 €
TZ510309510515	STA. TS10	95- 105 L= 150	EPDM	43,02 €
TZ510309510520	STA. TS10	95- 105 L= 200	EPDM	51,84 €
TZ510309510525	STA. TS10	95- 105 L= 250	EPDM	68,87 €
TZ510309510530	STA. TS10	95- 105 L= 300	EPDM	76,21 €
TZ510309510540	STA. TS10	95- 105 L= 400	EPDM	99,53 €
TZ510309510550	STA. TS10	95- 105 L= 500	EPDM	119,18 €
TZ510310211215	STA. TS10	102- 112 L= 150	EPDM	44,42 €
TZ510310211220	STA. TS10	102- 112 L= 200	EPDM	53,72 €
TZ510310211225	STA. TS10	102- 112 L= 250	EPDM	71,20 €
TZ510310211230	STA. TS10	102- 112 L= 300	EPDM	78,68 €
TZ510310211240	STA. TS10	102- 112 L= 400	EPDM	102,77 €
TZ510310511520	STA. TS10	105- 115 L= 200	EPDM	54,10 €
TZ510310511530	STA. TS10	105- 115 L= 300	EPDM	91,01 €
TZ510310611615	STA. TS10	106- 116 L= 150	EPDM	44,89 €
TZ510310611620	STA. TS10	106- 116 L= 200	EPDM	54,08 €
TZ510310611625	STA. TS10	106- 116 L= 250	EPDM	71,94 €
TZ510310611630	STA. TS10	106- 116 L= 300	EPDM	79,51 €
TZ510310611640	STA. TS10	106- 116 L= 400	EPDM	103,85 €
TZ510310811815	STA. TS10	108- 118 L= 150	EPDM	45,83 €
TZ510310811820	STA. TS10	108- 118 L= 200	EPDM	55,21 €
TZ510310811825	STA. TS10	108- 118 L= 250	EPDM	73,43 €
TZ510310811830	STA. TS10	108- 118 L= 300	EPDM	81,16 €
TZ510310811840	STA. TS10	108- 118 L= 400	EPDM	106,01 €
TZ510311312315	STA. TS10	113- 123 L= 150	EPDM	46,78 €
TZ510311312320	STA. TS10	113- 123 L= 200	EPDM	56,35 €
TZ510311312325	STA. TS10	113- 123 L= 250	EPDM	74,94 €
TZ510311312330	STA. TS10	113- 123 L= 300	EPDM	82,83 €
TZ510311312340	STA. TS10	113- 123 L= 400	EPDM	108,17 €
TZ510311512615	STA. TS10	115- 126 L= 150	EPDM	49,03 €
TZ510311512620	STA. TS10	115- 126 L= 200	EPDM	56,91 €
TZ510311812815	STA. TS10	118- 128 L= 150	EPDM	47,70 €
TZ510311812820	STA. TS10	118- 128 L= 200	EPDM	57,47 €
TZ510311812825	STA. TS10	118- 128 L= 250	EPDM	76,44 €
TZ510311812830	STA. TS10	118- 128 L= 300	EPDM	84,47 €
TZ510311812840	STA. TS10	118- 128 L= 400	EPDM	110,35 €
TZ510312013115	STA. TS10	120- 131 L= 150	EPDM	48,64 €
TZ510312013120	STA. TS10	120- 131 L= 200	EPDM	58,60 €
TZ510312013125	STA. TS10	120- 131 L= 250	EPDM	77,94 €
TZ510312013130	STA. TS10	120- 131 L= 300	EPDM	86,15 €
TZ510312013140	STA. TS10	120- 131 L= 400	EPDM	112,61 €
TZ510312513515	STA. TS10	125- 135 L= 150	EPDM	49,57 €
TZ510312513520	STA. TS10	125- 135 L= 200	EPDM	59,73 €
TZ510312513525	STA. TS10	125- 135 L= 250	EPDM	79,43 €
TZ510312513530	STA. TS10	125- 135 L= 300	EPDM	87,79 €
TZ510312513540	STA. TS10	125- 135 L= 400	EPDM	114,68 €
TZ510313014020	STA. TS10	130- 140 L= 200	EPDM	60,83 €
TZ510313014025	STA. TS10	130- 140 L= 250	EPDM	81,13 €
TZ510313214415	STA. TS10	132- 144 L= 150	EPDM	51,44 €
TZ510313214420	STA. TS10	132- 144 L= 200	EPDM	61,98 €
TZ510313214425	STA. TS10	132- 144 L= 250	EPDM	82,43 €
TZ510313214430	STA. TS10	132- 144 L= 300	EPDM	91,12 €
TZ510313214440	STA. TS10	132- 144 L= 400	EPDM	118,99 €
TZ510313514515	STA. TS10	135- 145 L= 150	EPDM	52,40 €
TZ510313514520	STA. TS10	135- 145 L= 200	EPDM	64,24 €
TZ510313514525	STA. TS10	135- 145 L= 250	EPDM	85,42 €
TZ510313514530	STA. TS10	135- 145 L= 300	EPDM	94,43 €
TZ510313514540	STA. TS10	135- 145 L= 400	EPDM	123,33 €
TZ510314015020	STA. TS10	140- 150 L= 200	EPDM	65,08 €
TZ510314015025	STA. TS10	140- 150 L= 250	EPDM	87,17 €
TZ510314515515	STA. TS10	145- 155 L= 150	EPDM	53,26 €
TZ510314515520	STA. TS10	145- 155 L= 200	EPDM	65,08 €
TZ510314515525	STA. TS10	145- 155 L= 250	EPDM	86,54 €
TZ510314515530	STA. TS10	145- 155 L= 300	EPDM	95,67 €
TZ510314515540	STA. TS10	145- 155 L= 400	EPDM	124,95 €
TZ510314815820	STA. TS10	148- 158 L= 200	EPDM	78,48 €
TZ510315116115	STA. TS10	151- 161 L= 150	EPDM	54,73 €
TZ510315116120	STA. TS10	151- 161 L= 200	EPDM	67,06 €
TZ510315116125	STA. TS10	151- 161 L= 250	EPDM	89,18 €
TZ510315116130	STA. TS10	151- 161 L= 300	EPDM	98,56 €
TZ510315116140	STA. TS10	151- 161 L= 400	EPDM	128,73 €
TZ510315917020	STA. TS10	159- 170 L= 200	EPDM	67,53 €
TZ510315917025	STA. TS10	159- 170 L= 250	EPDM	89,96 €
TZ510315917030	STA. TS10	159- 170 L= 300	EPDM	99,68 €
TZ510315917040	STA. TS10	159- 170 L= 400	EPDM	130,12 €
TZ510316517615	STA. TS10	165- 176 L= 150	EPDM	57,05 €
TZ510316517620	STA. TS10	165- 176 L= 200	EPDM	69,30 €
TZ510316517625	STA. TS10	165- 176 L= 250	EPDM	92,17 €
TZ510316517630	STA. TS10	165- 176 L= 300	EPDM	101,88 €
TZ510316517640	STA. TS10	165- 176 L= 400	EPDM	133,06 €
TZ510316517650	STA. TS10	165- 176 L= 500	EPDM	154,04 €
TZ510316717720	STA. TS10	167- 177 L= 200	EPDM	69,88 €
TZ510316717725	STA. TS10	167- 177 L= 250	EPDM	92,92 €
TZ510316717730	STA. TS10	167- 177 L= 300	EPDM	102,70 €
TZ510316717740	STA. TS10	167- 177 L= 400	EPDM	134,13 €
TZ510316717750	STA. TS10	167- 177 L= 500	EPDM	155,18 €
TZ510317018220	STA. TS10	170- 182 L= 200	EPDM	70,43 €
TZ510317018225	STA. TS10	170- 182 L= 250	EPDM	93,66 €
TZ510317018230	STA. TS10	170- 182 L= 300	EPDM	103,54 €
TZ510317018240	STA. TS10	170- 182 L= 400	EPDM	135,22 €
TZ510317018250	STA. TS10	170- 182 L= 500	EPDM	162,59 €
TZ510317418420	STA. TS10	174- 184 L= 200	EPDM	71,56 €
TZ510317418425	STA. TS10	174- 184 L= 250	EPDM	95,18 €
TZ510317418430	STA. TS10	174- 184 L= 300	EPDM	105,18 €
TZ510317418440	STA. TS10	174- 184 L= 400	EPDM	137,39 €
TZ510317618620	STA. TS10	176- 186 L= 200	EPDM	72,67 €



ABRAZADERA DE REPARACION
TS10 - 1 SECTOR

(DISPONIBLES OTRAS MEDIDAS, LARGOS Y TIPOS DE JUNTA)

TZ510317618625	STA. TS10	176- 186 L= 250	EPDM	96,67 €
TZ510317618630	STA. TS10	176- 186 L= 300	EPDM	106,84 €
TZ510317618640	STA. TS10	176- 186 L= 400	EPDM	139,55 €
TZ510318019120	STA. TS10	180- 191 L= 200	EPDM	73,81 €
TZ510318019125	STA. TS10	180- 191 L= 250	EPDM	98,17 €
TZ510318019130	STA. TS10	180- 191 L= 300	EPDM	108,49 €
TZ510318019140	STA. TS10	180- 191 L= 400	EPDM	141,72 €
TZ510318619620	STA. TS10	186- 196 L= 200	EPDM	74,94 €
TZ510318619625	STA. TS10	186- 196 L= 250	EPDM	99,68 €
TZ510318619630	STA. TS10	186- 196 L= 300	EPDM	110,15 €
TZ510318619640	STA. TS10	186- 196 L= 400	EPDM	143,87 €
TZ510319020020	STA. TS10	190- 200 L= 200	EPDM	78,37 €
TZ510319320320	STA. TS10	193- 203 L= 200	EPDM	76,06 €
TZ510319320325	STA. TS10	193- 203 L= 250	EPDM	101,16 €
TZ510319320330	STA. TS10	193- 203 L= 300	EPDM	111,81 €
TZ510319320340	STA. TS10	193- 203 L= 400	EPDM	146,04 €
TZ510320021220	STA. TS10	200- 212 L= 200	EPDM	78,41 €
TZ510320021225	STA. TS10	200- 212 L= 250	EPDM	103,43 €
TZ510320021230	STA. TS10	200- 212 L= 300	EPDM	114,68 €
TZ510320021240	STA. TS10	200- 212 L= 400	EPDM	149,67 €
TZ510320922020	STA. TS10	209- 220 L= 200	EPDM	79,98 €
TZ510320922025	STA. TS10	209- 220 L= 250	EPDM	106,12 €
TZ510320922030	STA. TS10	209- 220 L= 300	EPDM	117,87 €
TZ510320922040	STA. TS10	209- 220 L= 400	EPDM	151,91 €
TZ510320922050	STA. TS10	209- 220 L= 500	EPDM	185,34 €
TZ510321522520	STA. TS10	215- 225 L= 200	EPDM	81,13 €
TZ510321522525	STA. TS10	215- 225 L= 250	EPDM	107,91 €
TZ510321522530	STA. TS10	215- 225 L= 300	EPDM	119,26 €
TZ510321522540	STA. TS10	215- 225 L= 400	EPDM	155,77 €
TZ510321923020	STA. TS10	219- 230 L= 200	EPDM	83,07 €
TZ510321923025	STA. TS10	219- 230 L= 250	EPDM	110,15 €
TZ510321923030	STA. TS10	219- 230 L= 300	EPDM	121,76 €
TZ510321923040	STA. TS10	219- 230 L= 400	EPDM	159,03 €
TZ510322223320	STA. TS10	222- 233 L= 200	EPDM	84,68 €
TZ510322223325	STA. TS10	222- 233 L= 250	EPDM	112,84 €
TZ510322223330	STA. TS10	222- 233 L= 300	EPDM	124,50 €
TZ510322223340	STA. TS10	222- 233 L= 400	EPDM	161,97 €
TZ510322824025	STA. TS10	228- 240 L= 250	EPDM	115,52 €
TZ510322824030	STA. TS10	228- 240 L= 300	EPDM	127,25 €
TZ510322824040	STA. TS10	228- 240 L= 400	EPDM	164,90 €
TZ510323724725	STA. TS10	237- 247 L= 250	EPDM	120,88 €
TZ510323724730	STA. TS10	237- 247 L= 300	EPDM	132,73 €
TZ510323724740	STA. TS10	237- 247 L= 400	EPDM	170,78 €
TZ510323924925	STA. TS10	239- 249 L= 250	EPDM	121,66 €
TZ510323924930	STA. TS10	239- 249 L= 300	EPDM	133,91 €
TZ510323924940	STA. TS10	239- 249 L= 400	EPDM	172,04 €
TZ510324325325	STA. TS10	243- 253 L= 250	EPDM	123,28 €
TZ510324325330	STA. TS10	243- 253 L= 300	EPDM	135,78 €
TZ510324325340	STA. TS10	243- 253 L= 400	EPDM	174,54 €
TZ510325026025	STA. TS10	250- 260 L= 250	EPDM	126,17 €
TZ510325026030	STA. TS10	250- 260 L= 300	EPDM	138,72 €
TZ510325026040	STA. TS10	250- 260 L= 400	EPDM	180,09 €
TZ510325226225	STA. TS10	252- 262 L= 250	EPDM	127,34 €
TZ510325226230	STA. TS10	252- 262 L= 300	EPDM	140,04 €
TZ510325226240	STA. TS10	252- 262 L= 400	EPDM	181,72 €
TZ510326127125	STA. TS10	261- 271 L= 250	EPDM	132,52 €
TZ510326127130	STA. TS10	261- 271 L= 300	EPDM	146,16 €
TZ510326127140	STA. TS10	261- 271 L= 400	EPDM	189,17 €
TZ510326127150	STA. TS10	261- 271 L= 500	EPDM	230,35 €
TZ510326627625	STA. TS10	266- 276 L= 250	EPDM	135,19 €
TZ510326627630	STA. TS10	266- 276 L= 300	EPDM	149,31 €
TZ510326627640	STA. TS10	266- 276 L= 400	EPDM	192,73 €
TZ510327028125	STA. TS10	270- 281 L= 250	EPDM	143,12 €
TZ510327028130	STA. TS10	270- 281 L= 300	EPDM	152,30 €
TZ510330031030	STA. TS10	300- 310 L= 300	EPDM	163,90 €
TZ510330531530	STA. TS10	305- 315 L= 300	EPDM	161,28 €

ABRAZADERA DE REPARACION
TS20 - 2 SECTORES
(DISPONIBLES OTRAS MEDIDAS, LARGOS Y TIPOS DE JUNTA)



TZ510331532630	STA. TS10	315- 326 L= 300	EPDM	161,94 €
TZ510408811020	STA. TS20	88- 110 L= 200	EPDM	80,49 €
TZ510408811025	STA. TS20	88- 110 L= 250	EPDM	107,05 €
TZ510408811030	STA. TS20	88- 110 L= 300	EPDM	118,32 €
TZ510408811040	STA. TS20	88- 110 L= 400	EPDM	163,91 €
TZ510410012020	STA. TS20	100- 120 L= 200	EPDM	83,18 €
TZ510410012025	STA. TS20	100- 120 L= 250	EPDM	110,63 €
TZ510410012030	STA. TS20	100- 120 L= 300	EPDM	122,27 €
TZ510410012040	STA. TS20	100- 120 L= 400	EPDM	164,97 €
TZ510410812820	STA. TS20	108- 128 L= 200	EPDM	84,78 €
TZ510410812825	STA. TS20	108- 128 L= 250	EPDM	111,34 €
TZ510410812830	STA. TS20	108- 128 L= 300	EPDM	124,62 €
TZ510410812840	STA. TS20	108- 128 L= 400	EPDM	166,54 €
TZ510411213420	STA. TS20	112- 134 L= 200	EPDM	86,39 €
TZ510411213425	STA. TS20	112- 134 L= 250	EPDM	114,90 €
TZ510411213430	STA. TS20	112- 134 L= 300	EPDM	127,01 €
TZ510411213440	STA. TS20	112- 134 L= 400	EPDM	167,31 €
TZ510411213450	STA. TS20	112- 134 L= 500	EPDM	209,14 €
TZ510412014020	STA. TS20	120- 140 L= 200	EPDM	88,01 €
TZ510412014025	STA. TS20	120- 140 L= 250	EPDM	117,05 €
TZ510412014030	STA. TS20	120- 140 L= 300	EPDM	129,36 €
TZ510412014040	STA. TS20	120- 140 L= 400	EPDM	168,25 €
TZ510413015020	STA. TS20	130- 150 L= 200	EPDM	89,61 €
TZ510413015025	STA. TS20	130- 150 L= 250	EPDM	119,19 €
TZ510413015030	STA. TS20	130- 150 L= 300	EPDM	131,74 €
TZ510413015040	STA. TS20	130- 150 L= 400	EPDM	172,06 €
TZ510413515520	STA. TS20	135- 155 L= 200	EPDM	90,70 €
TZ510413515525	STA. TS20	135- 155 L= 250	EPDM	120,61 €
TZ510413515530	STA. TS20	135- 155 L= 300	EPDM	133,31 €
TZ510413515540	STA. TS20	135- 155 L= 400	EPDM	174,12 €
TZ510414016020	STA. TS20	140- 160 L= 200	EPDM	92,29 €
TZ510414016025	STA. TS20	140- 160 L= 250	EPDM	122,77 €
TZ510414016030	STA. TS20	140- 160 L= 300	EPDM	135,67 €
TZ510414016040	STA. TS20	140- 160 L= 400	EPDM	177,22 €
TZ510414016050	STA. TS20	140- 160 L= 500	EPDM	221,51 €
TZ510415818020	STA. TS20	158- 180 L= 200	EPDM	93,90 €
TZ510415818025	STA. TS20	158- 180 L= 250	EPDM	124,90 €
TZ510415818030	STA. TS20	158- 180 L= 300	EPDM	138,04 €
TZ510415818040	STA. TS20	158- 180 L= 400	EPDM	180,30 €
TZ510415818050	STA. TS20	158- 180 L= 500	EPDM	225,37 €
TZ510416518520	STA. TS20	165- 185 L= 200	EPDM	95,51 €
TZ510416518525	STA. TS20	165- 185 L= 250	EPDM	127,04 €
TZ510416518530	STA. TS20	165- 185 L= 300	EPDM	140,41 €
TZ510416518540	STA. TS20	165- 185 L= 400	EPDM	183,38 €
TZ510416518550	STA. TS20	165- 185 L= 500	EPDM	229,13 €
TZ510416819020	STA. TS20	168- 190 L= 200	EPDM	96,59 €
TZ510416819025	STA. TS20	168- 190 L= 250	EPDM	128,45 €
TZ510416819030	STA. TS20	168- 190 L= 300	EPDM	141,98 €
TZ510416819040	STA. TS20	168- 190 L= 400	EPDM	185,46 €
TZ510416819050	STA. TS20	168- 190 L= 500	EPDM	231,80 €
TZ510417019020	STA. TS20	170- 190 L= 200	EPDM	97,67 €
TZ510417019025	STA. TS20	170- 190 L= 250	EPDM	129,89 €
TZ510417019030	STA. TS20	170- 190 L= 300	EPDM	143,56 €
TZ510417019040	STA. TS20	170- 190 L= 400	EPDM	187,51 €
TZ510417019050	STA. TS20	170- 190 L= 500	EPDM	234,39 €
TZ510417619620	STA. TS20	176- 196 L= 200	EPDM	99,27 €
TZ510417619625	STA. TS20	176- 196 L= 250	EPDM	132,03 €
TZ510417619630	STA. TS20	176- 196 L= 300	EPDM	145,93 €
TZ510417619640	STA. TS20	176- 196 L= 400	EPDM	190,59 €
TZ510417619650	STA. TS20	176- 196 L= 500	EPDM	238,26 €
TZ510419021020	STA. TS20	190- 210 L= 200	EPDM	101,96 €
TZ510419021025	STA. TS20	190- 210 L= 250	EPDM	135,60 €
TZ510419021030	STA. TS20	190- 210 L= 300	EPDM	149,87 €
TZ510419021040	STA. TS20	190- 210 L= 400	EPDM	195,76 €
TZ510419021050	STA. TS20	190- 210 L= 500	EPDM	244,70 €
TZ510419521720	STA. TS20	195- 217 L= 200	EPDM	104,64 €
TZ510419521725	STA. TS20	195- 217 L= 250	EPDM	139,18 €
TZ510419521730	STA. TS20	195- 217 L= 300	EPDM	153,83 €
TZ510419521740	STA. TS20	195- 217 L= 400	EPDM	200,91 €
TZ510419521750	STA. TS20	195- 217 L= 500	EPDM	251,14 €
TZ510421023020	STA. TS20	210- 230 L= 200	EPDM	106,78 €
TZ510421023025	STA. TS20	210- 230 L= 250	EPDM	142,03 €
TZ510421023030	STA. TS20	210- 230 L= 300	EPDM	156,97 €
TZ510421023040	STA. TS20	210- 230 L= 400	EPDM	205,02 €
TZ510421023050	STA. TS20	210- 230 L= 500	EPDM	255,96 €
TZ510421623825	STA. TS20	216- 238 L= 250	EPDM	146,30 €
TZ510421623830	STA. TS20	216- 238 L= 300	EPDM	161,71 €
TZ510421623840	STA. TS20	216- 238 L= 400	EPDM	211,21 €
TZ510421623850	STA. TS20	216- 238 L= 500	EPDM	264,01 €
TZ510422524620	STA. TS20	225- 246 L= 200	EPDM	112,70 €
TZ510422524625	STA. TS20	225- 246 L= 250	EPDM	149,87 €
TZ510422524630	STA. TS20	225- 246 L= 300	EPDM	165,65 €
TZ510422524640	STA. TS20	225- 246 L= 400	EPDM	216,36 €
TZ510422524650	STA. TS20	225- 246 L= 500	EPDM	270,46 €
TZ510423025020	STA. TS20	230- 250 L= 200	EPDM	121,08 €
TZ510423826020	STA. TS20	238- 260 L= 200	EPDM	118,22 €
TZ510423826025	STA. TS20	238- 260 L= 250	EPDM	157,02 €



ABRAZADERA DE REPARACION
TS20 - 2 SECTORES

(DISPONIBLES OTRAS MEDIDAS, LARGOS Y TIPOS DE JUNTA)

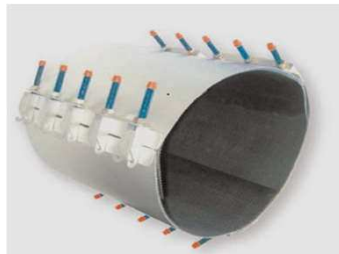

ABRAZADERA DE REPARACION
TS30 - 3 SECTORES

(DISPONIBLES OTRAS MEDIDAS, LARGOS Y TIPOS DE JUNTA)

TZ510423826030	STA. TS20 238- 260 L= 300 EPDM	173,53 €
TZ510423826040	STA. TS20 238- 260 L= 400 EPDM	226,66 €
TZ510423826050	STA. TS20 238- 260 L= 500 EPDM	283,33 €
TZ510425027130	STA. TS20 250- 271 L= 300 EPDM	187,59 €
TZ510426928925	STA. TS20 269- 289 L= 250 EPDM	182,45 €
TZ510426928930	STA. TS20 269- 289 L= 300 EPDM	202,31 €
TZ510426928940	STA. TS20 269- 289 L= 400 EPDM	262,94 €
TZ510426928950	STA. TS20 269- 289 L= 500 EPDM	329,68 €
TZ510427329320	STA. TS20 273- 293 L= 200 EPDM	139,31 €
TZ510427329325	STA. TS20 273- 293 L= 250 EPDM	185,68 €
TZ510427329330	STA. TS20 273- 293 L= 300 EPDM	205,53 €
TZ510427329340	STA. TS20 273- 293 L= 400 EPDM	267,18 €
TZ510427329350	STA. TS20 273- 293 L= 500 EPDM	337,06 €
TZ510428230230	STA. TS20 282- 302 L= 300 EPDM	209,27 €
TZ510428230240	STA. TS20 282- 302 L= 400 EPDM	272,07 €
TZ510428230250	STA. TS20 282- 302 L= 500 EPDM	343,21 €
TZ510429531530	STA. TS20 295- 315 L= 300 EPDM	214,11 €
TZ510429531540	STA. TS20 295- 315 L= 400 EPDM	278,34 €
TZ510429531550	STA. TS20 295- 315 L= 500 EPDM	351,13 €
TZ510431433530	STA. TS20 314- 335 L= 300 EPDM	240,36 €
TZ510431433540	STA. TS20 314- 335 L= 400 EPDM	280,43 €
TZ510431433550	STA. TS20 314- 335 L= 500 EPDM	353,77 €
TZ510432234440	STA. TS20 322- 344 L= 400 EPDM	286,01 €
TZ510432234450	STA. TS20 322- 344 L= 500 EPDM	360,83 €
TZ510433735840	STA. TS20 337- 358 L= 400 EPDM	293,68 €
TZ510433735850	STA. TS20 337- 358 L= 500 EPDM	269,19 €
TZ510434736830	STA. TS20 347- 368 L= 300 EPDM	252,97 €
TZ510434736840	STA. TS20 347- 368 L= 400 EPDM	299,97 €
TZ510434736850	STA. TS20 347- 368 L= 500 EPDM	378,43 €
TZ510436538530	STA. TS20 365- 385 L= 300 EPDM	261,07 €
TZ510436538540	STA. TS20 365- 385 L= 400 EPDM	313,91 €
TZ510436538550	STA. TS20 365- 385 L= 500 EPDM	396,01 €
TZ510439541540	STA. TS20 395- 415 L= 400 EPDM	327,36 €
TZ510439541550	STA. TS20 395- 415 L= 500 EPDM	412,98 €
TZ510440042040	STA. TS20 400- 420 L= 400 EPDM	329,40 €
TZ510440042050	STA. TS20 400- 420 L= 500 EPDM	420,16 €
TZ510442044040	STA. TS20 420- 440 L= 400 EPDM	338,07 €
TZ510442044050	STA. TS20 420- 440 L= 500 EPDM	442,84 €
TZ510443545540	STA. TS20 435- 455 L= 400 EPDM	361,09 €
TZ510443545550	STA. TS20 435- 455 L= 500 EPDM	450,00 €
TZ510445047030	STA. TS20 450- 470 L= 300 EPDM	0,00 €
TZ510445047040	STA. TS20 450- 470 L= 400 EPDM	364,59 €
TZ510445047050	STA. TS20 450- 470 L= 500 EPDM	454,53 €
TZ510445047060	STA. TS20 450- 470 L= 600 EPDM	488,91 €
TZ510446848840	STA. TS20 468- 488 L= 400 EPDM	378,15 €
TZ510446848850	STA. TS20 468- 488 L= 500 EPDM	467,21 €
TZ510446848860	STA. TS20 468- 488 L= 600 EPDM	486,36 €
TZ510450052040	STA. TS20 500- 520 L= 400 EPDM	412,07 €
TZ510450052050	STA. TS20 500- 520 L= 500 EPDM	470,90 €
TZ510450052060	STA. TS20 500- 520 L= 600 EPDM	627,84 €
TZ510527030030	STA. TS30 270- 300 L= 300 EPDM	233,54 €
TZ510527030040	STA. TS30 270- 300 L= 400 EPDM	261,00 €
TZ510531034030	STA. TS30 310- 340 L= 300 EPDM	251,78 €
TZ510531034040	STA. TS30 310- 340 L= 400 EPDM	281,39 €
TZ510534037030	STA. TS30 340- 370 L= 300 EPDM	266,38 €
TZ510534037040	STA. TS30 340- 370 L= 400 EPDM	297,72 €
TZ510539542540	STA. TS30 395- 425 L= 400 EPDM	365,47 €
TZ510539542550	STA. TS30 395- 425 L= 500 EPDM	488,82 €
TZ510540043040	STA. TS30 400- 430 L= 400 EPDM	366,90 €
TZ510540043050	STA. TS30 400- 430 L= 500 EPDM	491,72 €
TZ510542045050	STA. TS30 420- 450 L= 500 EPDM	503,34 €
TZ510544047050	STA. TS30 440- 470 L= 500 EPDM	514,94 €
TZ510544047060	STA. TS30 440- 470 L= 600 EPDM	620,09 €
TZ510547550550	STA. TS30 475- 505 L= 500 EPDM	530,29 €
TZ510547550560	STA. TS30 475- 505 L= 600 EPDM	636,31 €
TZ510553056050	STA. TS30 530- 560 L= 500 EPDM	544,76 €
TZ510553056060	STA. TS30 530- 560 L= 600 EPDM	673,58 €
TZ510557060060	STA. TS30 570- 600 L= 600 EPDM	708,20 €

OTROS MODELOS



DERIVACIÓN A BRIDA TIPO ARA

DIMENSIONES HABITUALES

DIÁMETRO TUBERÍA
Desde 88 mm a 810 mm

SALIDA A BRIDA
Desde DN50 a DN200

Otras medidas, consultar



DERIVACION A ROSCA TIPO AR

DIMENSIONES HABITUALES

DIÁMETRO TUBERÍA
Desde 88 mm a 315 mm

SALIDA A ROSCA
Desde 1/2" a 2"

Otras medidas,
consultar

CONSULTE LO QUE NECESITA, SOMOS FABRICANTES: DIMENSIONES. ANCHO. JUNTA EN NBR. SECTORES. TIPOS DE SALIDA. ETC.

* Es posible que en tuberías plásticas, las abrazaderas no alcancen el nivel de presión esperado, la razón principal de esto es la gran variedad de los productores de tubos de PE y de estructuras de PE. También es posible que el orificio de la brida pueda moverse un poco por este motivo.

BANDAS INOX Y CABEZALES DE ACOMETIDA CA-R Y ACUSTOP-R

PRODUCTO	CODIGO	DN	RANGO	CAJA	PVP 2019 €	
 <p>BANDAS INOX PARA CABEZALES CA-R Y ACUSTOP-R</p>	AC164051	60	65-90	12	19,84	
	AC164052	80	95-110	12	20,41	
	AC164053	100	110-135	12	20,96	
	AC164054	125	135-165	12	22,48	
	AC164055	150	165-190	6	23,78	
	AC164056	175	190-215	6	24,78	
	AC164057	200	215-240	6	26,77	
	AC164058	225	235-265	6	27,78	
	AC164059	250	265-290	4	29,21	
	AC164060	275	290-320	4	31,02	
	AC164061	300	320-345	4	32,97	
	AC164062	325	345-375	4	35,07	
 <p>CABEZAL ROSCADO CA-R</p>	AC163071	1/2"		6	14,17	
	AC163072	3/4"		6	14,17	
	AC163073	1"		6	14,17	
	AC163074	1 1/4"		6	15,78	
	AC163075	1 1/2"		6	15,78	
	AC163076	2"		6	18,94	
 <p>CABEZALES ROSCADO EN CARGA ACUSTOP-R</p>	AC263127	3/4"		6	35,49	
	AC263128	1"		6	34,15	
	AC263129	1 1/4"		6	34,15	
	AC263130	1 1/2"		6	36,21	
	AC263125	2"		6	37,77	
 <p>ADAPTADOR ROSCADO PARA INTERVENCIONES EN CARGA (ARIC)</p>	AC163396	1" M x 1" F		10	31,46	
	AC163397	2" M x 2" F		10	33,86	
NOTA: PARA COLLARINES ACUSTOP-R Y COLLARINES ROSCADOS PARA PE BH.525						
 <p>COMPLEMENTOS PARA ARIC Y ACUSTOP-R</p>	AC263194	1 1/2"	JUNTA GUARDAPOLVOS	1	6,42	
	AC263195	2"	JUNTA GUARDAPOLVOS	1	8,34	
	AC163050	de 3/1 1/2"	ESPÁTULA DE INTERVENCIÓN	1	26,22	
	AC163051	2"	ESPÁTULA DE INTERVENCIÓN	1	31,97	
NOTA: PARA COLLARINES ACUSTOP-R Y COLLARINES ROSCADOS PARA PE BH.525						

COLLARÍN DE ACOMETIDA SALIDA TUBO PE, MODELO CA

PRODUCTO	CODIGO	DN	RANGO	CAJA	PVP 2019 €
	AC163400	60 25MD		6	38,17
	AC163401	60 32MD	(63- 82)	6	38,17
	AC163402	60 40MD		6	40,82
	AC163406	80 25MD		6	38,74
	AC163407	80 32MD		6	38,74
	AC163408	80 40MD	(80-115)	6	41,39
	AC163140	80 50MD		6	54,16
	AC163409	100 25MD		6	40,19
	AC163410	100 32MD		6	40,97
	AC163411	100 40MD	(112-142)	6	42,16
	AC163141	100 50MD		6	57,28
	AC163412	125 25MD		6	42,73
	AC163413	125 32MD	(140-170)	6	43,56
	AC163414	125 40MD		6	42,34
	AC163142	125 50MD		6	56,72
	AC163415	150 25MD		6	44,94
	AC163416	150 32MD	(168-198)	6	45,86
	AC163417	150 40MD		6	46,92
	AC163143	150 50MD		6	60,78
	AC163418	175 25MD		4	43,57
	AC163419	175 32MD	(190-220)	4	44,36
	AC163420	175 40MD		4	46,16
	AC163144	175 50MD		4	59,84
	AC163421	200 25MD		4	48,04
	AC163422	200 32MD	(218-250)	4	48,52
	AC163423	200 40MD		4	49,00
	AC163145	200 50MD		4	60,13
	AC163424	225 25MD		4	44,67

COLLARIN CA CON SALIDA TUBO DE PE100	AC163425	225 32MD	(248-285)	4	45,48
	AC163426	225 40MD		4	47,27
	AC163446	225 50MD		4	64,50
	AC163427	250 25MD	(282-315)	4	45,85
	AC163428	250 32MD		4	46,67
	AC163429	250 40MD		4	48,66
	AC163447	250 50MD	(315-347)	4	62,42
	AC163430	300 25MD		4	47,23
	AC163431	300 32MD		4	48,09
	AC163432	300 40MD	(345-380)	4	49,79
	AC163448	300 50MD		4	63,55
	AC163433	300A 25MD		4	50,85
	AC163434	300A 32MD	4	51,73	
	AC163435	300A 40MD	4	52,60	
	AC163449	300A 50MD	4	64,95	

COLLARÍN DE ACOMETIDA SALIDA PE EN CARGA, MODELO CA-C

PRODUCTO	CODIGO	DN	RANGO	CAJA	PVP 2019 €
	AC163525	60 25MD	(63- 82)	6	52,50
	AC163526	60 32MD		6	52,97
	AC163527	60 40MD		6	53,48
	AC163528	80 25MD	(80-115)	6	54,25
	AC163529	80 32MD		6	54,79
	AC163530	80 40MD		6	56,00
	AC163560	80 50MD	(94-115)	6	68,98
	AC163575	80 63MD		6	69,27
	AC163531	100 25MD		(112-142)	6
	AC163532	100 32MD	6		57,03
	AC163533	100 40MD	6		58,24
	AC163561	100 50MD	(140-170)	6	71,69
	AC163576	100 63MD		6	72,44
	AC163534	125 25MD		6	59,30
	AC163535	125 32MD	(168-198)	6	59,89
AC163536	125 40MD	6		60,46	
AC163562	125 50MD	6		73,23	
AC163577	125 63MD	(190-220)	6	73,73	
AC163537	150 25MD		6	61,40	
AC163538	150 32MD		6	62,05	
AC163539	150 40MD	(218-250)	6	63,15	
AC163563	150 50MD		6	75,92	
AC163578	150 63MD		6	76,71	
AC163540	175 25MD	(248-285)	6	62,81	
AC163541	175 32MD		6	63,22	
AC163542	175 40MD		6	63,88	
AC163564	175 50MD	(282-315)	6	78,91	
AC163579	175 63MD		6	79,54	
AC163543	200 25MD		4	64,73	
AC163544	200 32MD	(315-347)	4	65,43	
AC163545	200 40MD		4	65,74	
AC163565	200 50MD		4	80,56	
AC163580	200 63MD	(345-380)	4	81,10	
AC163546	225 25MD		4	65,39	
AC163547	225 32MD		4	66,10	
AC163548	225 40MD	(218-250)	4	67,04	
AC163566	225 50MD		4	81,60	
AC163581	225 63MD		4	82,49	
AC163549	250 25MD	(282-315)	4	66,77	
AC163550	250 32MD		4	67,50	
AC163551	250 40MD		4	68,39	
AC163567	250 50MD	(315-347)	4	82,26	
AC163582	250 63MD		4	83,08	
AC163552	300 25MD		4	68,17	
AC163553	300 32MD	(345-380)	4	68,73	
AC163554	300 40MD		4	69,26	
AC163568	300 50MD		4	84,48	
AC163583	300 63MD	(218-250)	4	84,87	
AC163555	325 25MD		4	71,48	
AC163556	325 32MD		4	71,91	
AC163557	325 40MD	(315-347)	4	72,74	
AC163569	325 50MD		4	89,14	
AC163584	325 63MD		4	89,80	
AC141050	UTIL GUIA EXTRACCION CA-C			1	CONSULTAR

COLLARIN CA-C
PARA TUBERÍAS EN CARGA



UTILGUIA EXTRACCIÓN CA-C

COLLARÍN DERIVACIÓN ROSCADA PARA TUBOS PE MODELO BH525

PRODUCTO	CODIGO	DN	CAJA	PVP 2019 €
	AC824025	40 3/4"	1	6,68
	AC825025	50 3/4"	1	10,32
	AC825032	50 1"	1	10,32
	AC825040	50 1 1/4"	1	10,32
	AC826325	63 3/4"	1	14,35
	AC826332	63 1"	1	14,35
	AC826340	63 1 1/4"	1	14,86
	AC826350	63 1 1/2"	1	17,86
	AC826363	63 2"	1	16,62
	AC827525	75 3/4"	1	17,86
	AC827532	75 1"	1	17,86
	AC827540	75 1 1/4"	1	16,62
	AC827550	75 1 1/2"	1	19,37
	AC827563	75 2"	1	18,32
	AC829025	90 3/4"	1	17,93
	AC829032	90 1"	1	17,92
	AC829040	90 1 1/4"	1	19,62
	AC829050	90 1 1/2"	1	20,96
	AC829063	90 2"	1	20,09
	AC821125	110 3/4"	1	24,00
	AC821132	110 1"	1	24,00
	AC821140	110 1 1/4"	1	23,36
	AC821150	110 1 1/2"	1	25,70

COLLARÍN ROSCADO PARA PE - BH525

COLLARIN DERIVACION PARA TUBOS PE

AC821163	110 2"	1	24,47
AC821175	110 2 1/2"	1	24,47
AC821225	125 3/4"	1	28,58
AC821232	125 1"	1	28,58
AC821240	125 1 1/4"	1	27,40
AC821250	125 1 1/2"	1	29,75
AC821263	125 2"	1	28,58
AC821275	125 2 1/2"	1	28,58
AC821290	125 3"	1	28,58
AC821432	140 1"	1	44,43
AC821440	140 1 1/4"	1	44,43
AC821450	140 1 1/2"	1	45,44
AC821463	140 2"	1	44,38
AC821475	140 2 1/2"	1	44,38
AC821490	140 3"	1	44,38
AC821632	160 1"	1	47,37
AC821640	160 1 1/4"	1	47,77
AC821650	160 1 1/2"	1	47,77
AC821663	160 2"	1	47,37
AC821675	160 2 1/2"	1	47,37
AC821690	160 3"	1	47,37
AC822032	200 1"	1	66,51
AC822040	200 1 1/4"	1	66,11
AC822050	200 1 1/2"	1	67,56
AC822063	200 2"	1	67,33
AC822075	200 2 1/2"	1	67,33
AC822090	200 3"	1	67,33
AC822563	250 2"	1	86,29
AC822590	250 3"	1	86,29
AC823163	315 2"	1	110,83
AC823190	315 3"	1	122,44

CABEZAL PARA DERIVACIONES A BRIDA

PRODUCTO	CODIGO	DN	RANGO	CAJA	PVP 2019 €
 <p>CABEZAL CON BRIDA</p>	AC107033	DN150-250	DN80-100	1	110,79
	AC107031	DN250-350	DN125-150	1	121,23
	AC107032	DN400-800	DN125-150	1	126,57

BANDAS

 <p>BANDAS INOX PARA COLLARINES BRIDADO</p>	AC107077	DN 125	(135 -155) L-355	1	27,09
	AC107079	DN 150	(165 -185) L-435	1	28,08
	AC107080	DN 175	(190 -210) L-500	1	29,13
	AC107082	DN 200	(210 -235) L-570	1	34,05
	AC107084	DN 200	(225 -250) L-610	1	34,79
	AC107043	DN 250	(260 -285) L-720	1	35,89
	AC107045	DN 250	(285 -310) L-790	1	38,17
	AC107047	DN 300	(320 -345) L-870	1	42,76
	AC107048	DN 300	(340 -365) L-920	1	43,60
	AC107049	DN 350	(365 -390) L-1007	1	46,13
	AC107050	DN 350	(390 -415) L-1083	1	47,46
	AC107051	DN 350-400	(415 -440) L-1155	1	49,05
	AC107052	DN 400	(450 -475) L-1240	1	50,77
	AC107053	DN 400-450	(475 -500) L-1307	1	52,00
	AC107054	DN 450	(500 -525) L-1410	1	53,10
	AC107058	DN 450-500	(525 -550) L-1455	1	54,75
	AC107059	DN 450-500	(550 -575) L-1526	1	61,34
	AC107060	DN 500	(575 -600) L-1627	1	61,34
	AC107061	DN 500	(600 -625) L-1690	1	61,34
	AC107062	DN 600	(625 -650) L-1770	1	61,34
AC107063	DN 600	(655 -680) L-1862	1	61,34	
AC107064	DN 600	(700 -725) L-1992	1	65,09	
AC107065	DN 600	(725 -750) L-2086	1	65,55	

MANGUITO Y BRIDA UNIVERSAL ACURANGE

PRODUCTO	CODIGO	DN	RANGO	CAJA	PVP 2019 €
 <p>UNIÓN MANGUITO UNIVERSAL</p>	AC830040	DN40	48-60	1	16,10
	AC830050	DN 50	59-72	1	18,55
	AC830065	DN65	63-88	1	21,70
	AC830080	DN80	88-103	1	29,05
	AC830100	DN100	109-128	1	32,55
	AC830125	DN125	135-153	1	46,55
	AC830150	DN150	159-182	1	52,50
	AC830175	DN175	192-210	1	67,90
	AC830200	DN200	218-235	1	82,25
	AC830250	DN250	250-267	1	98,00
	AC830251	DN250A	272-289	1	102,55
	AC830300	DN300	315-332	1	117,95
	AC830301	DN300	322-339	1	121,80
	AC830350	DN350	351-378	1	173,25
	AC830400	DN400	417-437	1	225,05
	AC830450	DN450	480-500	1	241,15
	AC830501	DN500	526-546	1	271,25
		DN600	600-630	1	323,40
	AC830600	DN600	630-650	1	344,05



UNIÓN BRIDA UNIVERSAL

AC831040	DN40 PN10/16	48-59	1		17,15
AC831050	DN50 PN10/16	59-72	1		19,95
AC831065	DN65 PN10/16	63-88	1		25,20
AC831080	DN80 PN10/16	88-103	1		32,20
AC831100	DN100 PN10/16	109-128	1		35,35
AC831125	DN125 PN10/16	135-153	1		43,05
AC831150	DN150 PN10/16	159-182	1		48,65
AC831175	DN200 PN10/16	192-210	1		57,40
AC831200	DN200 PN10/16	218-235	1		68,25
AC831250	DN250 PN10/16	242-262	1		90,30
AC831251	DN250 PN10/16	250-267	1		90,30
	DN250 PN10/16	272-289	1		90,65
AC831300	DN300 PN10/16	315-332	1		109,55
AC831301	DN300 PN10/16	322-339	1		110,25
	DN350 PN10/16	340-360	1		176,40
	DN350 PN10/16	351-378	1		176,40
AC831350	DN350 PN10/16	374-391	1		176,40
AC831400	DN400 PN10/16	417-437	1		211,05
AC831500	DN500 PN10/16	526-546	1		289,80
AC831501	DN500 PN10/16	630-350	1		373,80

ADAPTADOR A BRIDA PARA PE-PVC

PRODUCTO	CODIGO	DN	RANGO	CAJA	PVP 2019 €
 <p>ADAPTADOR A BRIDA PARA PE/PVC AUTOBLOCANTE</p>		40,00	40	1	9,8
		40,00	50	1	10,5
	AC396361	50-65	63	1	14,35
	AC396362	65,00	75	1	18,55
	AC396363	80,00	90	1	22,40
	AC396364	100,00	110	1	29,75
	AC396365	125,00	125	1	37,45
	AC396366	125,00	140	1	43,40
	AC396367	150,00	160	1	51,80
	AC396369	200,00	200	1	67,90
	AC396372	200,00	225	1	73,85
	AC396370	250,00	250	1	95,90
	AC396371	300,00	315	1	134,75
		400,00	400	1	209,65

REVESTIMIENTOS ANTICORROSIÓN

PRODUCTO	CODIGO	DESCRIPCIÓN	FORMATO	UNDS	PVP 2019€
 <p>REVESTIMIENTOS EN FRIO</p>	AC531018	CINTA WRAP 65/75 TAPE 50 mm x 15 m	Rollo	12	12,14
	AC531019	CINTA WRAP 50/40 TAPE 100 mm x 15 m	Rollo	8	24,11
	AC531020	CINTA WRAP 50/40 TAPE 150 mm x 15 m	Rollo	8	33,69
	AC531064	IMPRIMACIÓN PRIMER B-400 (Lata 5 L)	5 litros	4	90,05
	AC531062	MASILLA MOULDING COMP.(Bote 6 Kg)	6 kg	4	36,79
	AC531032	PETROLATUM TAPE 50 mm x10 m	Rollo	36	5,01
	AC531031	PETROLATUM TAPE 100 mm x10 m	Rollo	18	10,04
	AC531033	PETROLATUM TAPE 150 mm x10 m	Rollo	12	15,17

EQUIPOS DE PERFORACIÓN PARA TUBERÍAS



MAQUINAS DE PERFORAR



PRODUCTO	CODIGO	DN	RANGO	PVP 2019 €
----------	--------	----	-------	------------

EQUIPO DE PERFORAR ACUDRILL



ADAPTADORES ROSCADOS + FRESA



PROPULSOR ACUDRILL 220V



RECAMBIOS Y ACCESORIOS

GL141150	MAQUINA PERFORAR ACUDRILL			1.250,00
GL141153	ADAPTADOR ROSCADO + FRESA		3/4"	71,00
GL141154			1"	71,00
GL141155			1 1/4"	73,00
GL141156			1 1/2"	75,00
GL141157			2"	79,00
GL441072	AC PROPULSOR ACUDRILL 220V (Opcional)			1.650,00
GL141170	PORTAFRESA + BROCA		14-30 mm	84,00
GL141171			32-46 mm	84,00
GL141175	BROCA PILOTO dia 6,5 ACUDRILL		6,5 mm	40,00

NOTA: PARA PERFORACIÓN SOBRE COLLARINES ROSCADOS HASTA 2"

EQUIPO DE PERFORAR ACUDRILL PLUS



ADAPTADOR A BRIDA



ADAPTADORES ROSCADOS

GL141200	ACUDRILL PLUS MAQ. PERFORAR			2.775,00
GL441076	PROPULSOR+ADAPT.ACUDRILL PLUS (opcional)			2.570,00
GL141204	ADAPTADOR ROSCADO + FRESA		2"	110,00
GL141206			2 1/2"	125,00
GL141208			3"	130,00
GL141220	ADAPTADOR BRIDA		DN65/80 PN10/16	290,00
GL141222			DN100/125 PN10/16	320,00
GL141224			DN150 PN10/16	390,00
GL141226			DN200 PN10/16	535,00
GL141232	PORTAFRESA + BROCA		6,35 mm	129,55

NOTA: PARA PERFORACIÓN SOBRE ROSCAS HASTA 3" Y BRIDAS HASTA DN200

EQUIPOS DE PERFORACIÓN PARA TUBERÍAS



MAQUINAS DE PERFORAR



PRODUCTO	CODIGO	DN	RANGO	VVP 2019 €
----------	--------	----	-------	------------

MAQUINA DE PERFORAR MP-185 A



CAMPANA

MAQUINA DE PERFORAR MP-185 A

RECAMBIOS *

GL141035	MP-185-A MAQUINA PERFORAR			1.060,00
GL141036	AC CAMPANA MP-185-A (incluye Fresa de paso variable)	25 mm		237,00
GL141037		32 mm		258,00
GL141038		40 mm		258,00
GL141039		50 mm		306,00
GL141040		63 mm		483,00

NOTA: PARA PERFORACIÓN SOBRE COLLARINES CON SALIDA A TUBO MODELOS CA Y CA-C



FRESA PARA TUBERÍAS PE

GL446202	FRESA PARA PE	22 mm		29,00
GL446205		29 mm		31,00
GL446206		30 mm		31,00
GL446208		35 mm		33,00
GL446210		40 mm		36,00
GL446212		48 mm		39,00
GL446218		60 mm		45,00
GL446222		76 mm		52,00

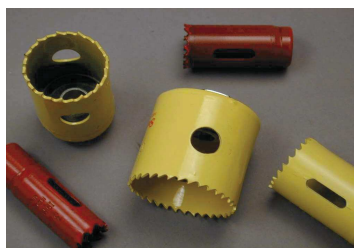

FRESA DE PASO VARIABLE PARA TUBERÍAS RÍGIDAS

GL446142	FRESA PASO VARIABLE (VP) Fibrocemento	Fundición /	14 mm	17,00
GL446143			17 mm	13,00
GL446145			19 mm	13,00
GL446148			22 mm	14,00
GL446149			25 mm	14,00
GL446150			27 mm	14,00
GL446152			30 mm	14,00
GL446153			33 mm	14,00
GL446154			35 mm	15,00
GL446160			38 mm	15,00
GL446168			46 mm	18,00
GL446167			48 mm	18,00
GL446170			60 mm	22,00
GL446171			70 mm	24,00
GL446172			76 mm	24,00
GL446174			86 mm	24,00
GL446175			89 mm	24,00
GL446176			95 mm	33,00
GL446177			114 mm	83,50
GL446178			127 mm	95,30
GL446179	140 mm	130,00		



FRESA CARBURO DE TUNGSTENO PARA TUBERÍAS RÍGIDAS

GL446111	FRESA CARBURO TUNGSTENO Hierro	Fundición /	16 mm	32,58
GL446112			19 mm	32,58
GL446114			22 mm	32,58
GL446115			25 mm	35,12
GL446116			29 mm	35,12
GL446121			32 mm	35,12
GL446117			35 mm	35,12
GL446118			38 mm	35,12
GL446119			44 mm	41,45
GL446120			48 mm	41,45
GL446125			60 mm	46,57
GL446130			70 mm	46,57
GL446131			76 mm	74,42
GL446135			86 mm	74,42
GL443140			114 mm	125,00

ACCESORIOS DE PE ELECTROSOLDABLES



ACCESORIOS ELECTROSOLDABLES EN PE100 RC



PRODUCTO	CÓDIGO	CÓDIGO	DN	PVP 2019 €
 <p>MANGUITO PE100 SDR17/PN10</p>	AG25173009017	A580060	90	11,00
	AG25173011017	A580061	110	13,08
	AG25173012517	A580062	125	19,75
	AG25173014017	A580063	140	24,80
	AG25173016017	A580064	160	25,88
	AG25173020017	A580066	200	44,11
	AG25173022517	A580067	225	64,58
	AG25173025017	A580068	250	88,90
	AG25173028017	A580069	280	130,26
	AG25173031517	A580070	315	151,38
	AG25173035517	A580071	355	300,62
	AG25173040017	A580072	400	377,61
	AG25173045017	A579021	450	584,00
	AG25173050017	A579075	500	CONSULTAR
	AG25373056017	A579076	560	CONSULTAR
	AG25373063017	A579077	630	CONSULTAR
	AG25373071017	A579078	710	CONSULTAR
AG70373080017	A579047	800	CONSULTAR	
 <p>MANGUITO PE100 SDR17-11-7,4 PN 10, PN16 y PN25</p>	AG25173002011	A579001	20	3,34
	AG25173002511	A579002	25	3,94
	AG25173003211	A579003	32	3,85
	AG25173004011	A579004	40	4,05
	AG25173005011	A579005	50	5,79
	AG25173006311	A579006	63	6,19
	AG25173007511	A579007	75	9,57
	AG25173009011	A579008	90	12,12
	AG25173011011	A579009	110	14,29
	AG25173012511	A579010	125	21,63
	AG25173014011	A579011	140	26,91
	AG25173016011	A579012	160	28,02
	AG25173018011	A579013	180	45,03
	AG25173020011	A579014	200	47,01
	AG25173022511	A579015	225	68,10
	AG25173025011	A579016	250	96,16
	AG25173028011	A579017	280	140,55
	AG25173031511	A579018	315	161,50
	AG25173035511	A579019	355	319,61
	AG25173040011	A579020	400	400,74
	AG25173045011	A579074	450	528,73
AG25173050011	A579022	500	CONSULTAR	
AG25373063011	A579038	630	CONSULTAR	
 <p>CODO 90° PE100 SDR11/PN16</p>	AG25171002011	A579100	20	9,91
	AG25171002511	A579101	25	9,92
	AG25171003211	A579102	32	9,91
	AG25171004011	A579103	40	12,55
	AG25171005011	A579104	50	15,95
	AG25171006311	A579105	63	16,85
	AG25171007511	A579106	75	25,84
	AG25171009011	A579107	90	30,78
	AG25171011011	A579108	110	44,42
	AG25171012511	A579109	125	61,57
	AG25171016011	A579110	160	120,07
	AG25171018011	A579115	180	188,19
	AG25171020011	A579114	200	259,93
	AG25171022511	A579113	225	273,23

ACCESORIOS DE PE ELECTROSOLDABLES



ACCESORIOS ELECTROSOLDABLES EN PE100 RC



PRODUCTO	CÓDIGO	CÓDIGO	DN	PVP 2019 €
 CODO 45° PE100 SDR11/PN16	AG25170002011	A579120	20	9,91
	AG25170002511	A579121	25	9,92
	AG25170003211	A579122	32	10,20
	AG25170004011	A579123	40	12,55
	AG25170005011	A579124	50	15,95
	AG25170006311	A579125	63	16,85
	AG25170007511	A579126	75	25,84
	AG25170009011	A579127	90	33,10
	AG25170011011	A579128	110	50,00
	AG25170012511	A579129	125	65,95
	AG25170016011	A579130	160	135,74
	AG25170018011	A579131	180	188,19
	AG25170020011	A579134	200	259,93
AG25170022511	A579133	225	285,86	
 REDUCCION PE100 SDR11/PN16	AG25177252011	A579175	25/20	5,02
	AG25177322011	A579176	32/20	5,42
	AG25177322511	A579177	32/25	5,42
	AG25177402011	A579178	40/20	6,26
	AG25177402511	A579179	40/25	6,26
	AG25177403211	A579180	40/32	6,92
	AG25177502511	A579181	50/25	8,63
	AG25177503211	A579182	50/32	8,63
	AG25177504011	A579183	50/40	9,48
	AG25177633211	A579184	63/32	11,26
	AG25177634011	A579185	63/40	11,31
	AG25177635011	A579186	63/50	11,31
	AG25177755011	A579187	75/50	14,84
	AG25177756311	A579188	75/63	15,29
	AG25177906311	A579189	90/63	17,65
	AG25177116311	A579195	110/63	28,80
	AG25177119011	A579190	110/90	28,80
	AG25177129011		125/90	37,67
	AG25177121111		125/110	37,67
	AG25177169011	A579196	160/90	50,20
AG25177161111	A579194	160/110	50,96	
		200/160	76,00	
AG25177221611	A579197	225/160	116,81	
 TE IGUAL PE100 SDR11/PN16	AG25176002011	A579140	20	10,09
	AG25176002511	A579141	25	10,09
	AG25176003211	A579142	32	10,09
	AG25176004011	A579143	40	12,80
	AG25176005011	A579144	50	16,14
	AG25176006311	A579145	63	16,87
	AG25176007511	A579146	75	26,84
	AG25176009011	A579147	90	29,80
	AG25176011011	A579148	110	50,61
	AG25176012511	A579149	125	64,98
	AG25176016011	A579150	160	114,40
	AG25176018011	A579151	180	201,34
	AG25176020011		200	296,30
	AG25176022511	A579153	225	312,02

ACCESORIOS DE PE ELECTROSOLDABLES



ACCESORIOS ELECTROSOLDABLES EN PE100 RC



PRODUCTO	CÓDIGO	CÓDIGO	DN	PVP 2019 €
 <p style="text-align: center;">TAPON PE100 SDR11/PN16</p>	AG25174002011	A579200	20	6,49
	AG25174002511	A579201	25	6,67
	AG25174003211	A579202	32	7,54
	AG25174004011	A579203	40	7,84
	AG25174005011	A579204	50	12,05
	AG25174006311	A579205	63	12,71
	AG25174007511	A579206	75	22,37
	AG25174009011	A579207	90	28,33
	AG25174011011	A579208	110	36,29
	AG25174012511	A579209	125	44,63
	AG25174016011	A579211	160	58,63
	AG25174018011	A579212	180	83,51
	AG25174020011	A579213	200	111,73
	AG25174022511	A579214	225	131,75
	AG25174025011	A579215	250	198,66
AG25174028011	A579216	280	274,76	
AG25174031511	A579217	315	362,09	
 <p style="text-align: center;">ADAPTADOR MACHO/HEMBRA DE TRANSICION PE/LATON</p>	AG25181002011	A579083	20 X 1/2 M	15,15
	AG25181002511	A579084	25 X 3/4 M	16,45
	AG25181003211	A579085	32 X 1 M	21,76
	AG25181004011	A579086	40 X 1 1/4 M	27,62
	AG25181005011	A579087	50 X 1 1/2 M	40,48
	AG25181006311	A579088	63 X 2 M	44,23
	MP70075050		75 X 2" M	98,90
	MP70075065		75 X 2 1/2" M	117,69
	MP70090080		90 X 3" M	156,81
	MP70110100		110 X 4" M	207,20
	MP70125100		125 X 4" M	213,63
	AG25180002011	A579092	20 X 1/2 H	14,86
	AG25180002511	A579094	25 X 3/4 H	16,09
	AG25180003211	A579099	32 X 1 H	17,82
	AG25180004011	A579097	40 X 1 1/4 H	25,00
AG25180005011	A579093	50 X 1 1/2 H	37,52	
AG25180006311	A579098	63 X 2 H	53,52	
80075065MP		75 X 2 1/2" H	105,82	
80090080MP		90 X 3" H	130,00	
80110100MP		110 X 4" H	182,25	
80125100MP		125 X 4" H	190,60	
 <p style="text-align: center;">COLLARIN DE TOMA EN CARGA PE100 SDR11/PN16</p>	AG25278632011	A579025	63/20	51,46
	AG25278633211	A579027	63/32	51,46
	AG25278634011	A579028	63/40	57,13
	AG25278636311	A579024	63/63	57,13
	AG25278903211	A579031	90/32	56,47
	AG25278906311	A579034	90/63	61,98
	AG25278112011	A579035	110/20	63,64
	AG25278113211	A579040	110/32	63,64
	AG25278114011	A579041	110/40	67,68
	AG25278116311	A579043	110/63	67,68
	AG25278122011	A579044	125/20	73,95
	AG25278123211	A579046	125/32	73,95
	AG25278124011	A579050	125/40	78,72
	AG25278126311	A579052	125/63	78,72
	AG25278162011	A579053	160/20	101,76
	AG25278163211	A579055	160/32	101,76
	AG25278164011	A579056	160/40	104,79
	AG25278166311	A579058	160/63	104,79
	AG25278183211	A579060	180/32	118,33
	AG25278186311	A579063	180/63	118,33
	AG25278202011	A579064	200/20	135,47
	AG25278203211	A579048	200/32	135,47
	AG25278204011	A579067	200/40	137,64
	AG25278206311	A579069	200/63	137,64
	AG25278223211	A579070	225/32	146,36
AG25278226311	A579073	225/63	156,00	

ACCESORIOS DE PE ELECTROSOLDABLES



ACCESORIOS ELECTROSOLDABLES EN PE100 RC



PRODUCTO	CÓDIGO	CÓDIGO	DN	PVP 2019 €
	AG70288902011	A580539	90/20	76,00
	AG70288903211	A580540	90/32	76,18
	AG70288904011	A580541	90/40	76,18
	AG70288906311	A580542	90/63	77,81
	AG70288112011	A580543	110/20	76,54
	AG70288113211	A580544	110/32	76,74
	AG70288114011	A580545	110/40	76,74
	AG70288116311	A580546	110/63	78,69
	AG70288122011	A580547	125/20	99,55
	AG70288123211	A580548	125/32	99,76
	AG70288124011	A580549	125/40	99,76
	AG70288126311	A580550	125/63	118,36
	AG70288163211	A580551	160/32	92,32
	AG70288164011	A580552	160/40	92,36
	AG70288165011	A580553	160/50	94,20
	AG70288166311	A580554	160/63	93,50
	AG70288169011	A580555	160/90	113,98
	AG70288161111	A580556	160/110	114,88
	AG70288183211	A580557	180/32	93,83
	AG70288184011	A580558	180/40	93,97
	AG70288185011	A580559	180/50	94,40
	AG70288186311	A580560	180/63	94,73
	AG70288189011	A580561	180/90	115,39
	AG70288181111	A580562	180/110	116,58
	AG70288223211	A580563	225/32	111,19
	AG70288224011	A580564	225/40	110,76
	AG70288225011	A580565	225/50	111,70
	AG70288226311	A580566	225/63	112,03
	AG70288229011	A580567	225/90	126,23
	AG70288221111	A580568	225/110	127,27
AG70288256311	A580569	250/63	119,55	
AG70288259011	A580570	250/90	136,21	
AG70288251111	A580571	250/110	137,15	
AG70288316311	A580572	315/63	120,46	
AG70288319011	A580573	315/90	137,62	
AG70288311111	A580574	315/110	138,71	
	AG25289359011	A580581	355/90 SDR11	CONSULTAR
	AG25289401111	A580582	400/110 SDR11	CONSULTAR
	AG25289451211	A580583	450/125 SDR11	CONSULTAR
	AG25289501611	A580584	500/160 SDR11	CONSULTAR
	AG25289561811	A580585	560/180 SDR11	CONSULTAR
	AG25289632011	A580586	630/200 SDR11	CONSULTAR
	AG25289712211	A580587	710/225 SDR11	CONSULTAR
	AG25289802511	A580588	800/250 SDR11	CONSULTAR
	AG25289902811	A580589	900/280 SDR11	CONSULTAR
	AG25289103111	A580590	1000/315 SDR11	CONSULTAR
	AG25289123511	A580591	1200/355 SDR11	CONSULTAR
	AG25289144011	A580592	1400/400 SDR11	CONSULTAR
	AG25289164511	A580593	1600/450 SDR11	CONSULTAR
	AG25289185017	A580594	1800/500 SDR17	CONSULTAR
	AG25289205617	A580595	2000/560 SDR17	CONSULTAR
AG25289226317	A580596	2250/630 SDR17	CONSULTAR	
AG25289257117	A580597	2500/710 SDR17	CONSULTAR	
	AG70373056017		560 SDR 17	CONSULTAR
	AG70373063017		630 SDR17	CONSULTAR
	AG70373071017		710 SDR 17	CONSULTAR
	AG70373080017		800 SDR 17	CONSULTAR
	AG70373090017		900 SDR 17	CONSULTAR
	AG70373100017		1000 SDR 17	CONSULTAR
	AG70373120017		1200 SDR 17	CONSULTAR
	AG70373140017		1400 SDR 17	CONSULTAR
	AG70373056011		560 SDR 11	CONSULTAR
	AG70373063011		630 SDR11	CONSULTAR
	AG70373071011		710 SDR 11	CONSULTAR
	AG70373080011		800 SDR 11	CONSULTAR
	AG70373090011		900 SDR 11	CONSULTAR

TOMA SIMPLE EF PE100 SDR11/PN16

**DERIVACION SADDLE ELECTROSOLDABLE
MODELO TOPLOAD PARA GRANDES DIÁMETROS**

**Acoples de electrofusión bifilares para
tuberías de gran diámetro**

ACCESORIOS DE PE ELECTROSOLDABLES



ACCESORIOS ELECTROSOLDABLES EN PE100 RC



PRODUCTO	CÓDIGO	CÓDIGO	DN	PVP 2019 €
----------	--------	--------	----	------------

VÁLVULAS DE PE Y TRANSICIONES ROSCADAS A PE

PRODUCTO	CODIGO	CODIGO	DESCRIPCION	PVP 2019 €
----------	--------	--------	-------------	------------



VALVULA DE BOLA EF (SIN REDUCTOR)

AG22333203211	A580803	DN32		197,42
AG22333205011	A580804	DN50		245,03
AG22333206311	A580805	DN63		335,22
AG22333209011	A580807	DN90		463,52
AG22333211011	A580808	DN110		593,12



VALVULA DE BOLA EF (CON REDUCTOR)

AG22333306311	A580815	DN63		453,08
AG22333309011	A580818	DN90		601,86
AG22333311011	A580819	DN110		733,57
AG22333312511	A580820	DN125		747,30
AG22333316011	A580822	DN160		1.604,67
AG22333318011	A580823	DN180		1.660,77
AG22333322511	A580825	DN225		2.527,93

ACCESORIOS DE PE



ACCESORIOS SOLDADURA PE100 TOPE PARA LA SOLDADURA A TOPE *



PRODUCTO	CÓDIGO	CÓDIGO	DN	PVP 2019 €
 <p style="text-align: center;">CODO POLIVALENTE 90° DE MOLDE PE100 SDR11/PN16</p>	AG25068002011	A579700	20	3,27
	AG25068002511	A579701	25	3,42
	AG25068003211	A579702	32	3,67
	AG25068004011	A579703	40	4,73
	AG25068005011	A579704	50	6,53
	AG25068006311	A579705	63	11,93
	AG25068007511	A579706	75	14,55
	AG25068009011	A579707	90	17,37
	AG25068011011	A579708	110	30,20
	AG25068012511	A579709	125	43,96
	AG25068014011	A579710	140	57,50
	AG25068016011	A579711	160	62,44
	AG25068018011	A579712	180	72,76
	AG25068020011	A579713	200	99,44
	AG25068022511	A579714	225	118,54
	AG25061025011	A579715	250	229,65
	AG25061028011	A579716	280	346,66
	AG25061031511	A579717	315	433,73
	A579718	355	CONSULTAR	
		400	CONSULTAR	
		450	CONSULTAR	
		500	CONSULTAR	
DISPONIBLES CODOS MANIPULADOS HASTA DN1000				
 <p style="text-align: center;">CODO POLIVALENTE 90° DE MOLDE PE100 SDR17/PN10</p>	AG25068006317	A579739	63	10,73
	AG25068007517	A579726	75	12,46
	AG25068009017	A579727	90	16,75
	AG25068011017	A579728	110	27,21
	AG25068012517	A579729	125	39,51
	AG25068014017	A579730	140	51,79
	AG25068016017	A579731	160	57,70
	AG25068018017	A579732	180	65,42
	AG25068020017	A579733	200	76,09
	AG25068022517	A579734	225	106,78
	AG25061025017	A579735	250	206,66
	AG25061028017	A579736	280	312,00
	AG25061031517	A579737	315	388,28
			355	CONSULTAR
			400	CONSULTAR
			450	CONSULTAR
			500	CONSULTAR
	DISPONIBLES CODOS MANIPULADOS HASTA DN1000			

ACCESORIOS DE PE



ACCESORIOS SOLDADURA PE100 TOPE PARA LA SOLDADURA A TOPE *



PRODUCTO	CÓDIGO	CÓDIGO	DN	PVP 2019 €	
 <p style="text-align: center;">CODO POLIVALENTE 45° DE MOLDE PE100 SDR11/PN16</p>	AG25060002011	A579745	20	3,56	
	AG25060002511	A579746	25	3,81	
	AG25060003211	A579747	32	4,59	
	AG25060004011	A579748	40	5,75	
	AG25060005011	A579749	50	6,53	
	AG25060006311	A579750	63	11,93	
	AG25060007511	A579751	75	14,82	
	AG25060009011	A579752	90	17,37	
	AG25060011011	A579753	110	30,24	
	AG25060012511	A579754	125	43,96	
	AG25060014011	A579755	140	57,50	
	AG25060016011	A579756	160	59,90	
	AG25060018011	A579757	180	72,76	
	AG25060020011	A579758	200	89,51	
	AG25060022511	A579759	225	118,54	
	AG25060025011	A579760	250	229,65	
	AG25060028011	A579761	280	346,66	
	AG25060031511	A579762	315	433,73	
	DISPONIBLES CODOS MANIPULADOS HASTA DN1000			355	CONSULTAR
				L400	CONSULTAR
			L450	CONSULTAR	
			L500	CONSULTAR	
			L560	CONSULTAR	
			L630	CONSULTAR	
			L710	CONSULTAR	
			L800	CONSULTAR	
 <p style="text-align: center;">CODO POLIVALENTE 45° DE MOLDE PE100 SDR17/PN10</p>	AG25060006317	A579770	63	10,73	
	AG25060007517	A579771	75	13,27	
	AG25060009017	A579772	90	16,75	
	AG25060011017	A579773	110	27,21	
	AG25060012517	A579774	125	39,51	
	AG25060014017	A579775	140	51,79	
	AG25060016017	A579776	160	50,86	
	AG25060018017	A579777	180	65,42	
	AG25060020017	A579778	200	76,03	
	AG25060022517	A579779	225	106,78	
	AG25060025017	A579780	250	175,55	
	AG25060028017	A579781	280	312,00	
	AG25060031517	A579782	315	329,44	
				355	CONSULTAR
				L400	CONSULTAR
				L450	CONSULTAR
				L500	CONSULTAR
				L560	CONSULTAR
				L630	CONSULTAR
				L710	CONSULTAR
			L800	CONSULTAR	
DISPONIBLES CODOS MANIPULADOS HASTA DN1000			L710	CONSULTAR	
			L800	CONSULTAR	

ACCESORIOS DE PE



ACCESORIOS SOLDADURA PE100 TOPE PARA LA SOLDADURA A TOPE *



PRODUCTO	CÓDIGO	CÓDIGO	DN	PVP 2019 €
 REDUCCIÓN POLIVALENTES PE100 SDR11/PN16	AG25067252011	A579905	25/20	2,35
	AG25067322011	A579906	32/20	2,64
	AG25067322511	A579907	32/25	2,64
	AG25067402011	A579908	40/20	3,81
	AG25067402511	A579909	40/25	3,81
	AG25067403211	A579910	40/32	3,81
	AG25067502511	A579911	50/25	4,73
	AG25067503211	A579912	50/32	4,73
	AG25067504011	A579913	50/40	4,73
	AG25067633211	A579914	63/32	6,29
	AG25067634011	A579915	63/40	6,29
	AG25067635011	A579916	63/50	6,29
	AG25067755011	A579917	75/50	9,70
	AG25067756311	A579918	75/63	9,70
	AG25067906311	A579919	90/63	13,60
	AG25067907511	A579920	90/75	13,72
	AG25067116311	A579921	110/63	17,11
	AG25067119011	A579922	110/90	17,11
	AG25067126311	A579923	125/63	21,98
	AG25067129011	A579924	125/90	21,98
	AG25067121111	A579925	125/110	22,06
	AG25067141211	A579926	140/125	31,65
	AG25067169011	A579927	160/90	42,39
	AG25067161111	A579928	160/110	42,39
	AG25067161211	A579929	160/125	42,39
	AG25067161411	A579930	160/140	42,39
	AG25067181211	A579931	180/125	54,93
	AG25067181611	A579932	180/160	54,93
	AG25067201611	A579933	200/160	60,17
	AG25067221611	A579934	225/160	96,82
	AG25067251611	A579935	250/160	137,01
	AG25067252111	A579936	250/200	137,01
	AG25067252211	A579939	250/225	137,01
	AG25067282511	A579940	280/250	181,00
AG25067312011	A579938	315/200	225,49	
AG25067312211	A579941	315/225	225,49	
AG25067312511	A579937	315/250	225,49	

ACCESORIOS DE PE



ACCESORIOS SOLDADURA PE100 TOPE PARA LA SOLDADURA A TOPE *



PRODUCTO	CÓDIGO	CÓDIGO	DN	PVP 2019 €
 <p style="text-align: center;">REDUCCIONES POLIVALENTES PE100 SDR17/PN10</p>	AG25067756317	A579945	75/63	9,70
	AG25067906317	A579946	90/63	13,60
	AG25067907517	A579947	90/75	13,72
	AG25067116317	A579948	110/63	17,11
	AG25067119017	A579949	110/90	17,11
	AG25067126317	A579950	125/63	21,98
	AG25067129017	A579951	125/90	21,98
	AG25067121117	A579952	125/110	22,06
	AG25067141217	A579953	140/125	31,65
	AG25067169017	A579954	160/90	42,39
	AG25067161117	A579955	160/110	42,39
	AG25067161217	A579956	160/125	42,39
	AG25067161417	A579957	160/140	42,39
	AG25067181217	A579958	180/125	54,93
	AG25067181617	A579959	180/160	54,93
	AG25067201617	A579960	200/160	60,17
	AG25067221617	A579961	225/160	96,82
	AG25067251617	A579963	250/160	137,01
	AG25067252117	A579962	250/200	137,01
	AG25067252217	A579964	250/225	137,01
	AG25067282517	A579965	280/250	181,00
	AG25067312017	A579966	315/200	225,49
	AG25067312217	A579968	315/225	225,49
	AG25067312517	A579967	315/250	225,49
	AG25007453117	A580380	C450 x 315	652,69
	AG25317564017	A580381	C560 x 400	2.379,27
	AG25317565017	A580382	C560 x 500	1.820,91
	AG25317635017	A580383	C630 x 500	2.887,76
	AG25317635617	A580384	C630 x 560	2.427,79
	AG25317715617	A580385	C710 x 560	4.304,09
AG25317716317	A580386	C710 x 630	3.147,63	
AG25317805617	A580387	C800 x 560	6.756,10	
AG25317807117	A580388	C800 x 710	4.683,11	

 <p style="text-align: center;">REDUCCIONES CORTAS PE100 EN PN6 - PN10 - PN16 - PN25</p>			225	CONSULTAR	
			355		250
					280
					315
			400		280
					315
					355
			450		315
					355
					400
			500		355
					400
					450
			560		400
500					
560					
630	450				
	500				
	560				
710	560				
	630				
800	710				
900	800				
1000	900				
1200	1000				

ACCESORIOS DE PE



ACCESORIOS SOLDADURA PE100 TOPE PARA LA SOLDADURA A TOPE *



PRODUCTO	CÓDIGO	CÓDIGO	DN	PVP 2019 €
 <p>TES POLIVALENTES 90° PE100 SDR11/PN16</p> <p style="background-color: #ffff00; color: black; padding: 2px;">DISPONIBLES TAMBIÉN CON LADOS CORTOS Y MANIPULADAS HASTA DN1000</p>	AG25066002011	A579795	20	3,56
	AG25066002511	A579796	25	4,05
	AG25066003211	A579797	32	4,85
	AG25066004011	A579798	40	6,02
	AG25066005011	A579799	50	7,95
	AG25066006311	A579800	63	10,98
	AG25066007511	A579801	75	17,01
	AG25066009011	A579802	90	25,94
	AG25066011011	A579803	110	32,24
	AG25066012511	A579804	125	52,09
	AG25066014011	A579805	140	83,67
	AG25066016011	A579806	160	92,14
	AG25066018011	A579807	180	142,48
	AG25066020011	A579808	200	173,47
	AG25066022511	A579809	225	242,60
	AG25066025011	A579810	250	313,22
	AG25066028011	A579811	280	469,72
	AG25066031511	A579812	315	601,52
			355	1.649,65
			400	2.363,94
		450	3.078,23	
		500	4.285,71	
		560	5.612,24	
		630	7.568,02	
 <p>TES POLIVALENTES 90° PE100 SDR17/PN10</p> <p style="background-color: #ffff00; color: black; padding: 2px;">DISPONIBLES TAMBIÉN CON LADOS CORTOS Y MANIPULADAS HASTA DN1000</p>	AG25066006317	A579820	63	9,96
	AG25066007517	A579821	75	16,20
	AG25066009017	A579822	90	23,26
	AG25066011017	A579823	110	29,99
	AG25066012517	A579824	125	46,85
	AG25066014017	A579825	140	75,30
	AG25066016017	A579826	160	83,05
	AG25066018017	A579827	180	128,22
	AG25066020017	A579828	200	155,83
	AG25066022517	A579829	225	218,28
	AG25066025017	A579830	250	255,26
	AG25066028017	A579831	280	422,80
	AG25066031517	A579832	315	495,37
			355	1.275,00
			400	1.955,00
			450	2.465,00
			500	3.485,00
		560	4.301,00	
		630	5.986,00	

ACCESORIOS DE PE



ACCESORIOS SOLDADURA PE100 TOPE PARA LA SOLDADURA A TOPE *



PRODUCTO	CÓDIGO	CÓDIGO	DN	PVP 2019 €
	AG25065633211		63/32	10,76
	AG25065635011	A579845	63/50	11,45
	AG25065753211	A579846	75/32	17,94
	AG25065755011	A579847	75/50	17,94
	AG25065756311	A579848	75/63	17,09
	AG25065906311	A579849	90/63	25,55
	AG25065907511	A579850	90/75	25,76
	AG25065116311	A579851	110/63	37,92
	AG25065117511	A579852	110/75	37,92
	AG25065119011	A579853	110/90	38,45
	AG25065127511		125/75	49,48
	AG25065129011	A579854	125/90	52,75
	AG25065121111	A579855	125/110	52,75
	AG25065166311	A579856	160/63	103,70
	AG25065167511	A579857	160/75	104,53
	AG25065169011	A579858	160/90	104,53
	AG25065161111	A579859	160/110	107,19
	AG25065189011	A579860	180/90	242,98
	AG25065181111	A579861	180/110	242,98
	AG25065181611	A579862	180/160	242,98
	AG25065206311	A579792	200/63	193,65
	AG25065209011	A579973	200/90	193,65
	AG25065201111	A579979	200/110	193,65
	AG25065201211	A579793	200/125	193,65
	AG25065201611	A579974	200/160	198,81
	AG25065227511	A579863	225/75	242,98
	AG25065229011	A579864	225/90	242,98
	AG25065221111	A579865	225/110	243,98
	AG25065221611	A579866	225/160	244,81
	AG25065221811	A579867	225/180	245,66
	AG25065319011		315/90	645,00
	AG25065311111	A579903	315/110	645,00
	AG25065311211		315/125	645,00
	AG25065311611	A579868	315/160	662,67
	AG25065311811		315/180	662,67
	AG25065312011		315/200	662,67
	AG25065312211	A579978	315/225	685,97
	AG25065312511		315/250	685,97
			110	
			160	
	355	225		
		250		
		110		
	400	160		
		225		
		160		
	450	225		
		315		
		160		
	500	250		
		160		
		250		
	630	160		
		250		

**TES REDUCIDAS DE MOLDE
POLIVALENTES PE100 SDR11 PN16**

**DISPONIBLES TAMBIÉN CON LADOS CORTOS
Y MANIPULADAS HASTA DN1000**

CONSULTAR

ACCESORIOS DE PE



ACCESORIOS SOLDADURA PE100 TOPE PARA LA SOLDADURA A TOPE *



PRODUCTO	CÓDIGO	CÓDIGO	DN	PVP 2019 €	
 <p>TES REDUCIDAS DE MOLDE POLIVALENTES PE100 SDR17 PN10</p> <p>DISPONIBLES TAMBIÉN CON LADOS CORTOS Y MANIPULADAS HASTA DN1000</p>	AG25065635017	A579875	63/50	10,59	
	AG25065755017	A579876	75/50	16,06	
	AG25065756317	A579877	75/63	16,30	
	AG25065906317	A579878	90/63	22,85	
	AG25065907517	A579879	90/75	23,07	
	AG25065116317	A579880	110/63	33,90	
	AG25065117517	A579881	110/75	33,90	
	AG25065119017	A579882	110/90	34,70	
	AG25065126317		125/63	46,45	
	AG25065129017	A579894	125/90	47,09	
	AG25065121117	A579883	125/110	47,09	
	AG25065166317	A579884	160/63	93,29	
	AG25065167517	A579885	160/75	96,16	
	AG25065169017	A579886	160/90	96,16	
	AG25065161117	A579887	160/110	97,05	
	AG25065189017	A579787	180/90	129,86	
	AG25065181617	A579888	180/160	129,71	
	AG25065206317	A579788	200/63	174,56	
	AG25065209017	A579869	200/90	174,56	
	AG25065201117	A579972	200/110	174,56	
	AG25065201217	A579789	200/125	174,56	
	AG25065201617	A579835	200/160	198,81	
	AG25065227517	A579889	225/75	218,89	
	AG25065229017	A579890	225/90	218,89	
	AG25065221117	A579891	225/110	219,62	
	AG25065221617	A579892	225/160	220,24	
	AG25065221817	A579893	225/180	220,61	
	AG25065251117		250/110	345,78	
	AG25065251617		250/160	345,78	
	AG25065252017		250/200	345,78	
	AG25065311117	A579873	315/110	609,66	
	AG25065311617	A579904	315/160	609,66	
	AG25065312017		315/200	609,66	
	AG25065312217	A579790	315/225	637,34	
	AG25065312517	A579791	315/250	637,34	
			110		
		355	160		
			225		
			250		
			110		
	400	160			
		225			
		160			
	450	225			
		315			
	500	160			
		250			
	560	250			
		160			
	630	250			
				CONSULTAR	

ACCESORIOS DE PE



ACCESORIOS SOLDADURA PE100 TOPE PARA LA SOLDADURA A TOPE *







PRODUCTO	CÓDIGO	CÓDIGO	DN	PVP 2019 €	
 <p style="text-align: center;">TAPON PE100 SDR11/PN16</p>  <p style="text-align: center;">TAPON CORTO PE100 SDR11/PN16</p>	AG25064002011	A579650	20	2,76	
	AG25064002511	A579651	25	3,02	
	AG25064003211	A579652	32	3,81	
	AG25064004011	A579653	40	4,73	
	AG25064005011	A579654	50	6,15	
	AG25064006311	A579655	63	8,13	
	AG25064007511	A579656	75	12,59	
	AG25064009011	A579657	90	17,83	
	AG25064011011	A579658	110	25,94	
	AG25064012511	A579659	125	28,02	
	AG25064014011	A579660	140	37,02	
	AG25064016011	A579661	160	36,86	
	AG25064018011	A579662	180	51,02	
	AG25064020011	A579663	200	63,57	
	AG25064022511	A579664	225	80,21	
	AG25064025011	A579665	250	113,70	
	AG25064028011	A579666	280	161,52	
	AG25064031511	A579667	315	229,47	
			C355	CONSULTAR	
			C 400	CONSULTAR	
		C 450	CONSULTAR		
		C 500	CONSULTAR		
		C 560	CONSULTAR		
		C 630	CONSULTAR		
		C 710	CONSULTAR		
		C 800	CONSULTAR		
 <p style="text-align: center;">TAPON PE100 SDR17/PN10</p>  <p style="text-align: center;">TAPON CORTO PE100 SDR17/PN10</p>	AG25064006317	A579675	63	8,13	
	AG25064007517	A579676	75	12,59	
	AG25064009017	A579677	90	17,83	
	AG25064011017	A579678	110	25,94	
	AG25064012517	A579679	125	28,02	
	AG25064014017	A579680	140	37,02	
	AG25064016017	A579681	160	36,86	
	AG25064018017	A579682	180	51,02	
	AG25064020017	A579683	200	63,57	
	AG25064022517	A579684	225	80,21	
	AG25064025017	A579685	250	102,31	
	AG25064028017	A579686	280	145,32	
	AG25064031517	A579687	315	205,36	
			C355	283,00	
			C400	327,00	
			C450	372,00	
			C500	478,70	
			C560	CONSULTAR	
		C630	CONSULTAR		
		C710	CONSULTAR		
		C800	CONSULTAR		

ACCESORIOS DE PE



ACCESORIOS SOLDADURA PE100 TOPE PARA LA SOLDADURA A TOPE *



PRODUCTO	CÓDIGO	CÓDIGO	DN	PVP 2019 €
 <p>PORTA BRIDA LARGO PE100 SDR11/PN16</p>  <p>PORTA BRIDA CORTOS PE100 SDR11/PN16</p>	AG25062002011	A579980	20	3,12
	AG25062002511	A579981	25	3,29
	AG25062003211	A579982	32	3,87
	AG25062004011	A579983	40	4,59
	AG25062005011	A579984	50	5,57
	AG25062006311	A579985	63	7,01
	AG25062007511	A579986	75	9,08
	AG25062009011	A579987	90	11,87
	AG25062011011	A579988	110	15,12
	AG25062012511	A579989	125	18,44
	AG25062014011	A579990	140	23,71
	AG25062016011	A579991	160	27,11
	AG25062018011	A579992	180	41,82
	AG25062020011	A579993	200	47,68
	AG25062022511	A579994	225	51,38
	AG25062025011	A579995	250	79,01
	AG25062028011	A579996	280	119,58
	AG25062031511	A579997	315	151,80
			355	319,60
		400	654,00	
		C 400	365,23	
		C 450	427,83	
		C 500	541,74	
		C 560	1.023,34	
		C 630	1.176,83	
		C 710	1.657,85	
		C 800	3.542,31	
 <p>PORTA BRIDA LARGOS PE100 SDR17/PN10</p>  <p>PORTA BRIDA CORTOS PE100 SDR17/PN10</p>	AG25062006317	A580005	63	7,01
	AG25062007517	A580006	75	9,08
	AG25062009017	A580007	90	11,87
	AG25062011017	A580008	110	15,12
	AG25062012517	A580009	125	18,44
	AG25062014017	A580010	140	23,71
	AG25062016017	A580011	160	27,11
	AG25062018017	A580012	180	41,82
	AG25062020017	A580013	200	47,68
	AG25062022517	A580014	225	51,38
	AG25062025017	A580015	250	71,11
	AG25062028017	A580016	280	107,65
	AG25062031517	A580017	315	141,20
			355	290,70
			400	595,00
			C 400	272,00
			C 450	385,00
			C 500	408,00
			C 560	527,00
		C 630	552,50	
		C 710	816,00	
		C 800	1.186,00	
		C900	1.462,00	
		C1000	1.785,00	

ACCESORIOS DE PE



ACCESORIOS SOLDADURA PE100 TOPE PARA LA SOLDADURA A TOPE *



PRODUCTO	CÓDIGO	CÓDIGO	DN	PVP 2019 €
 <p>PORTA BRIDAS CON CHAFLÁN PE100 PARA INSTALAR JUNTO A VALVULAS DE MARIPOSA (no incluida) EN SDR17 PN10 Y SDR11 PN16</p>	AG25062911017		DN110 PN10	23,33
	AG25062911011		DN110 PN16	23,33
	AG25062914017		DN140 PN10	36,63
	AG25062914011		DN140 PN16	42,50
	AG25062916017		DN160 PN10	46,03
	AG25062916011		DN160 PN16	57,61
	AG25062920017		DN200 PN10	80,94
	AG25062920011		DN200 PN16	104,74
	AG25062922517		DN225 PN10	87,28
	AG25062922511		DN225 PN16	108,02
	AG25062925017		DN250 PN10	141,68
	AG25062925011		DN250 PN16	165,48
	AG25062928017		DN280 PN10	166,18
	AG25062928011		DN280 PN16	193,82
	AG25062931517		DN315 PN10	218,00
	AG25062931511		DN315 PN16	257,85
	AG25062935517		DN355 PN10	376,83
	AG25062935511		DN355 PN16	405,01
AG25062940017		DN400 PN10	664,89	
AG25062940011		DN400 PN16	714,52	

(*) NOTA: Todos los accesorios son polivalentes (para soldadura a tope y por electrofusión), salvo los artículos donde en el DN se indica la letra C o se indica que son cortos que significa que sólo se puede soldar mediante soldadura a tope.

ACCESORIOS DE PE

ACUSTER

KITS PORTABRIDAS Y BRIDAS LOCAS PARA PE



PRODUCTO	CÓDIGO	DN	PVP 2019 €
 KIT PORTABRIDAS SDR11/PN16 PORTABRIDAS + BRIDA	AC171640	63 DN 50	17,72
	AC171641	63 DN 65	20,20
	AC171642	75 DN 65	20,92
	AC171643	90 DN 80	25,65
	AC171644	110 DN 100	30,11
	AC171645	125 DN 100	33,61
	AC171646	125 DN 125	42,64
	AC171647	140 DN 125	49,25
	AC171648	160 DN 150	51,87
	AC171649	180 DN 150	66,10
	AC171650	180 DN 175	80,86
	AC171651	200 DN 200	82,39
	AC171652	225 DN 200	85,61
	AC171653	250 DN 250	130,66
	AC171655	315 DN 300	214,14
 KIT PORTABRIDAS SDR17/PN10 PORTABRIDAS + BRIDA	AC171620	63 DN 50	17,72
	AC171621	63 DN 65	20,20
	AC171622	75 DN 65	20,92
	AC171623	90 DN 80	25,65
	AC171624	110 DN 100	30,11
	AC171625	125 DN 100	33,61
	AC171626	125 DN 125	42,64
	AC171627	140 DN 125	49,25
	AC171628	160 DN 150	51,87
	AC171629	180 DN 150	66,10
	AC171630	180 DN 175	80,86
	AC171631	200 DN 200	79,29
	AC171632	225 DN 200	82,51
	AC171633	250 DN 250	115,01
	AC171635	315 DN 300	200,35
 BRIDA ACERO SDR11/PN16	AC171179	PE 32 (DN25-PN10/16)	8,78
	AC171177	PE 40 (DN32-PN10/16)	11,05
	AC171188	PE 50 (DN40-PN10/16)	13,05
	AC171178	PE 63 (DN50-PN10/16)	12,54
	AC171191	PE 63 (DN65-PN10/16)	14,96
	AC171187	PE 75 (DN65-PN10/16)	14,08
	AC171201	PE 90 (DN80-PN10/16)	16,04
	AC171181	PE 110 (DN100-PN10/16)	17,76
	AC171184	PE 125 (DN100-PN10/16)	19,17
	AC171200	PE 125 (DN125-PN10/16)	28,29
	AC171190	PE 140 (DN 125-PN10/16)	31,04
	AC171182	PE 160 (DN150-PN10/16)	29,08
	AC171208	PE 180 (DN150-PN10/PN16)	32,68
	AC171205	PE 180(DN 175-PN10/PN16)	45,72
	AC171185	PE 200-225 (DN200-PN16)	42,02
	AC171203	PE 250 (DN 250-PN16)	64,99
	AC171186	PE 315 (DN300-PN16)	84,15
	AC171212	PE 355 (DN 350-PN 16)	162,24
	AC171209	PE 400 (DN 400-PN 16)	194,32
	AC171216	PE 450 (DN 500-PN 16)	354,42
AC171229	PE 500 (DN 500-PN 16)	346,74	
AC171218	PE 630 (DN 600-PN 16)	492,89	

ACCESORIOS DE PE

ACUSTER

KITS PORTABRIDAS Y BRIDAS LOCAS PARA PE



PRODUCTO	CÓDIGO	DN	PVP 2019 €
 <p>BRIDA ACERO SDR17/PN10</p>	AC171183	PE 200-225 (DN200-PN10)	38,83
	AC171199	PE 250 (DN 250-PN10)	54,57
	AC171189	PE 315 (DN300-PN10)	81,61
	AC171211	PE 355 (DN 350-PN 10)	143,85
	AC171214	PE 400 (DN 400-PN 10)	169,76
	AC171215	PE 450 (DN 500-PN 10)	305,42
	AC171228	PE 500 (DN 500-PN 10)	280,85
	AC171217	PE 630 (DN 600-PN 10)	340,53
  <p>BRIDAS LOCAS ACERO RECUBIERTO DE PP</p>	AG14014002011	PE 20 (DN15 PN10/16)	6,62
	AG14014002511	PE 25 (DN20 PN10/16)	7,28
	AG14014003211	PE 32 (DN25 PN10/16)	9,42
	AG14014004011	PE 40 (DN32 PN10/16)	11,90
	1756050040	PE 50 (DN40 PN10/16)	14,46
	1756063050	PE 63 (DN50 PN10/16)	14,54
	1756075080	PE 75 (DN65 PN10/16)	20,24
	1756090080	PE 90 (DN80 PN10/16)	18,96
	1756110100	PE 110 (DN100 PN10/16)	24,03
	1756125100	PE 125 (DN100 PN10/16)	25,93
	1756140125	PE 140 (DN125 PN10/16)	28,19
	1756160150	PE 160 (DN150 PN10/16)	37,66
	1756180150	PE 180 (DN150 PN10/16)	39,99
	1754200200	PE 200 (DN200 PN16)	60,75
	1754225200	PE 225 (DN200 PN16)	62,25
	1754250250	PE 250 (DN250 PN16)	86,93
	1754280250	PE 280 (DN250 PN16)	88,78
	1754315300	PE 315 (DN300 PN16)	126,73
	1756200200	PE 200 (DN200 PN10)	51,96
	1756225200	PE 225 (DN200 PN10)	54,28
	1756250250	PE 250 (DN250 PN10)	82,58
	1756280250	PE 280 (DN250 PN10)	88,24
	1756315300	PE 315 (DN300 PN10)	92,08
	AG14014035511	PE 355 (DN350 PN10)	267,02
	AG14014040011	PE 400 (DN400 PN10)	359,84
AG14014045011	PE 450 (DN500 PN10)	374,19	
 <p>BRIDA CIEGA ACERO RECUBIERTO DE PP</p>	AG14045006311	BRIDA CIEGA PP-FRP DN 63 PN10/16	52,63
	AG14045007511	BRIDA CIEGA PP-FRP DN 75 PN10/16	60,48
	AG14045009011	BRIDA CIEGA PP-FRP DN 90 PN10/16	66,57
	AG14045011011	BRIDA CIEGA PP-FRP DN 110 PN10/16	90,93
	AG14045014011	BRIDA CIEGA PP-FRP DN 140 PN10/16	111,65
	AG14045016011	BRIDA CIEGA PP-FRP DN 160 PN10/16	140,88
	AG14045020011	BRIDA CIEGA PP-FRP DN 200 PN10	156,49
	AG14045025011	BRIDA CIEGA PP-FRP DN 250 PN10	204,51
AG14045031511	BRIDA CIEGA PP-FRP DN 315 PN10	298,59	

MAQUINAS DE SOLDADURA PARA TUBERÍAS PLÁSTICAS



MÁQUINAS DE SOLDADURA A TOPE ELÉCTRICAS



PRODUCTO	CÓDIGO	DESCRIPCIÓN	RANGO	PVP 2019 €
 <p>ODS DYNAMIC AUTOMATICA SOLDADURA A TOPE</p>	GL178129	EQUIPO SOLDADURA A TOPE ODS DYNAMIC E-15 225 C/SCANNER	63-225	11.710,00
	SISTEMA ODS: EQUIPO TOTALMENTE ELÉCTRICO, CON TRAZABILIDAD Y HOMOLOGADO PARA GAS			
 <p>ODS TWIN AUTOMATICA SOLDADURA A TOPE + ELECTROFUSION</p>	GL178121	ODS TWIN E-15 225 C/SCANNER	63-225	12.480,00
	SISTEMA ODS: EQUIPO TOTALMENTE ELÉCTRICO, CON TRAZABILIDAD Y HOMOLOGADO PARA GAS			
 <p>SUPLEMENTOS PARA ODS</p>	GL171328	SET ADAPTERS 63/200		3.760,00
	GL171311	ODS E-99 JGO SUP.225X200(8PZA)		495,00
	GL171314	ODS-GE JGO.SUPL.200X180(8PZA)		536,00
	GL171315	ODS-GE JGO.SUPL.200X160(8PZA)		505,00
	GL171317	ODS-GE JGO.SUPL.200X140(8PZA)		484,00
	GL171318	ODS-GE JGO.SUPL.200X125(8PZA)		484,00
	GL171319	ODS-GE JGO.SUPL.200X110(8 PZA)		567,00
	GL171320	ODS-GE JGO.SUPL.200X90(8PZA)		567,00
	GL171321	ODS-GE JGO.SUPL.110X75(8PZA)		294,00
	GL171322	ODS-GE JGO.SUPL.110X63(8PZA)		330,00



MAQUINAS HIDRÁULICAS PARA SOLDADURA A TESTA MODELO TRACK





PRODUCTO	CÓDIGO	DESCRIPCIÓN	RANGO	PVP 2019 €
 <p>SOLDADURA A TOPE MANUAL MODELO TRACK MANUAL</p>	GL578800	TRACK 160 MANUAL	50-160	5.238,00
	GL578801	TRACK 250 MANUAL	75-250	7.169,00
	GL578802	TRACK 315 MANUAL	90-315	9.100,00
	GL578803	TRACK 400 MANUAL	160-400	10.259,00
	GL578804	TRACK 500 MANUAL	250-500	12.875,00
	GL578805	TRACK 630 MANUAL	355-630	19.915,00
	GL578806	TRACK 800 MANUAL	630-800	38.795,00
	GL578807	TRACK 1200 MANUAL	710-1200	75.875,00
	GL578808	TRACK 1400 MANUAL	800-1400	SEGÚN OFERTA

MAQUINAS DE SOLDADURA PARA TUBERÍAS PLÁSTICAS





MÁQUINAS DE SOLDADURA A TOPE ELÉCTRICAS



PRODUCTO	CÓDIGO	DESCRIPCIÓN	RANGO	PVP 2019 €
 	GL178700	ODS TRACK DYNAMIC E-15 160	50-160	11.953,00
	GL178701	ODS TRACK-DYNAMIC E-15 250	75-250	13.545,00
	GL178702	ODS TRACK-DYNAMIC E-15 315	90-315	14.147,00
	GL178703	ODS TRACK-DYNAMIC E-15 315 GAS	90-315	16.738,00
	GL178704	ODS TRACK-DYNAMIC E-15 400	160-400	17.716,00
	GL178705	ODS TRACK-DYNAMIC E-15 500	250-500	20.234,00



MAQUINAS DE SOLDADURA A TOPE
MODELO TRACK ODS

EQUIPO TRACK HIDRÁULICO AUTOMATIZADO CON SISTEMA ODS DYNAMIC CON TRAZABILIDAD (INCLUYE ADAPTADORES)

 	GL178710	ODS TRACK-TWIN E-15 160	50-160	13.395,00
	GL178711	ODS TRACK-TWIN E-15 250	75-250	14.987,00
	GL178712	ODS TRACK-TWIN E-15 315	90-315	15.589,00
	GL178713	ODS TRACK-TWIN E-15 315 GAS	90-315	18.180,00
	GL178714	ODS TRACK-TWIN E-15 400	160-400	19.158,00
	GL178715	ODS TRACK-TWIN E-15 500	250-500	21.676,00

MAQUINAS SOLDADURA A TOPE + ELECTROFUSIÓN
MODELO TRACK ODS

EQUIPO TRACK HIDRÁULICO AUTOMATIZADO CON SISTEMA ODS TWIN CON TRAZABILIDAD

  	A178420	ADAPT. MAQ. TRACK 250 AUTOM.	75-250	
	A178421	ADAPT. MAQ. TRACK 315 AUTOM.	90-315	
	A178425	ADAPT. MAQ. TRACK 315 GAS AUTOM.	90-315	
	A178422	ADAPT. MAQ. TRACK 400 AUTOM.	160-400	
	A178423	ADAPT. MAQ. TRACK 500 AUTOM.	250-500	

ADAPTACIÓN A AUTOMÁTICA

AUTOMATIZACIÓN TRACK HIDRÁULICO DEL CLIENTE CON SISTEMA ODS TWIN O DYNAMIC CON TRAZABILIDAD

ACCESORIO LARGO Y TUBO

	GL578262	SET COMPLETO DE ADAPTADORES PARA TRACK 160	50-160	1.700,00
	GL578263	SET COMPLETO DE ADAPTADORES PARA TRACK 250	75-250	2.657,00
	GL578264	SET COMPLETO DE ADAPTADORES PARA TRACK 315	90-315	3.064,00
	GL578265	SET COMPLETO DE ADAPTADORES PARA TRACK 400	160-400	2.936,00
	GL578266	SET COMPLETO DE ADAPTADORES PARA TRACK 500	250-500	5.330,00
	GL578267	SET COMPLETO DE ADAPTADORES PARA TRACK 630	355-630	9.425,00
	GL578268	SET COMPLETO DE ADAPTADORES PARA TRACK 800	630-800	14.369,00
	GL578269	SET COMPLETO DE ADAPTADORES PARA TRACK 1200	710-1200	
	GL578260	SET COMPLETO DE ADAPTADORES PARA TRACK 1400	800-1400	

ACCESORIO CORTO Y TUBO

	GL578094	SET STD&KNIFE ADAPTADORES TRACK 160	50-160	1.818,00
	GL578095	SET STD&KNIFE ADAPTADORES TRACK 250	75-250	2.807,00
	GL578096	SET STD&KNIFE ADAPTADORES TRACK 315	90-315	3.322,00
	GL578097	SET STD&KNIFE ADAPTADORES TRACK 400	160-400	3.234,00
	GL578098	SET STD&KNIFE ADAPTADORES TRACK 500	250-500	5.825,00
	GL578099	SET STD&KNIFE ADAPTADORES TRACK 630	315-630	13.390,00

SET ADAPTADORES PARA TRACK

MAQUINAS DE SOLDADURA PARA TUBERÍAS PLÁSTICAS



EQUIPOS DE SOLDADURA POR ELECTROFUSIÓN



PRODUCTO	CÓDIGO	DESCRIPCIÓN	HOMOLOGACIÓN	RANGO	PVP 2019 €	
      <p>EQUIPOS SOLDAR ELECTROFUSION</p>	GL578001	LITTLE BEAT MANUAL	AGUA	DN 125	842,00	
	GL578002	LITTLE BEAT AUTOMÁTICA CON ESCANER	AGUA	DN 125	917,00	
	GL178095	BEAT MV E12 MANUAL	AGUA	> DN315*	1.375,00	
	GL178103	BEAT-2 E12 AUTOMÁTICA CON ESCANER	AGUA	> DN315*	1.460,00	
	GL177100	BEAT-TR E12 CON ESCANER Y TRAZABILIDAD	GAS & AGUA	> DN630*	2.135,00	
	*Posibilidad de soldar diámetros superiores. Consultar					
	GL178842	BEAT HF-TR E-15 ALTA FRECUENCIA, ESCANER Y TRAZABILIDAD	GAS & AGUA	SIN LÍMITE	2.575,00	
	GL178605	ODS MODULO TWIN E15 230V CON ESCANER Y TRAZABILIDAD	GAS & AGUA	> DN 630	5.923,00	
	S/C	INCORPORACIÓN SISTEMA AR PARA EQUIPOS GAMA BEAT *	GAS & AGUA			
	(*) El sistema AR está especialmente indicado para dotar al equipo de electrofusión continuada de accesorios de gran diámetro y para climas muy cálidos. Se puede implantar en cualquier equipo de la gama BEAT.					



RECAMBIOS EQUIPOS DE SOLDADURA POR ELECTROFUSIÓN



PRODUCTO	CÓDIGO	DESCRIPCIÓN	RANGO	PVP 2019 €
  	GL478085	SCANNER SERIE RS-232		196,00
	GL478084	SCANNER USB		268,00
	GL178085	SCANNER SERIE AMPHENOL		278,00
	GL578299	SET DE 2 ADAPTADORES 4 mm LITTLE BEAT		31,00
	GL578300	SET DE 2 ADAPTADORES 4.7 mm LITTLE BEAT		31,00
	GL271733	ADAPT.ELECT.4.0 mm (2 PZA) BEAT		62,00
	GL271734	ADAPT.ELECT.4.7 mm (2 PZA) BEAT		62,00
	GL578655	CAJA ALUMINIO GAMA ODS		113,00
	GL578656	CAJA ALUMINIO GAMA BEAT		113,00
	 			

ÚTILES Y HERRAMIENTAS





EQUIPOS DE SOLDADURA POR ELECTROFUSIÓN





PRODUCTO	CÓDIGO	DESCRIPCIÓN	TIPO	PVP 2019 €
 RASPADOR MANUAL ROTATORIO	GL507300	Raspador manual 20mm x 1,9mm de grosor de pared		138,02 €
	GL507301	Raspador manual 20mm x 3,0mm de grosor de pared		138,02 €
	GL507302	Raspador manual 20mm x SDR11 de grosor de pared		138,02 €
	GL507303	Raspador manual 25mm x 2,3mm de grosor de pared		138,02 €
	GL507304	Raspador manual 25mm x 3,0mm de grosor de pared		138,02 €
	GL507305	Raspador manual 25mm x SDR11 de grosor de pared		138,02 €
	GL507306	Raspador manual 32mm x 3,0mm de grosor de pared		138,02 €
	GL507307	Raspador manual 32mm x SDR11 de grosor de pared		138,02 €
	GL507308	Raspador manual 40mm x 3,7mm de grosor de pared		155,70 €
	GL507309	Raspador manual 50mm x 4,6mm de grosor de pared		160,88 €
	GL507310	Raspador manual 63mm x 5,8mm de grosor de pared		180,61 €
 RASPADOR MANUAL PARA SALIDAS DE TOMA EN CARGA PE	GL507601	Raspador manual para tomas en carga 20mm x SDR11		139,02 €
	GL507602	Raspador manual para tomas en carga 25mm x SDR11		139,02 €
	GL507603	Raspador manual para tomas en carga 32mm x SDR11 (3,0mm)		139,02 €
	GL507604	Raspador manual para tomas en carga 40mm x SDR11 (3,7mm)		155,70 €
	GL507605	Raspador manual para tomas en carga 50mm x SDR11 (4,6mm)		160,88 €
	GL507606	Raspador manual para tomas en carga 63mm x SDR11 (5,8mm)		180,61 €
	GL507610	Cuchilla de recambio		57,93 €
 RASPADOR MANUAL 4 CUCHILLAS	GL571071	Raspador Manual + 4 cuchillas		13,09 €
	GL576018	Cuchilla rasp. Manual		9,62 €
 RASPADOR ROTATORIO	GL518201	Raspador rotatorio 32mm		291,93 €
	GL518202	Raspador rotatorio 40mm		308,15 €
	GL518203	Raspador rotatorio 50mm		324,37 €
	GL518204	Raspador rotatorio 55mm		340,58 €
	GL518205	Raspador rotatorio 63mm		356,80 €
	GL518206	Raspador rotatorio 70mm		373,02 €
	GL518208	Cuchilla de recambio		64,87 €
 RASPADOR MECÁNICO	GL570146	Raspador 63-315mm		1.066,38 €
	GL570147	Raspador 90-400mm		1.103,68 €
	GL570148	Raspador 110-500mm		1.211,20 €
	GL570149	Raspador 250-710mm		1.974,42 €
	GL517291	Cuchilla de recambio para todos los modelos mencionados arriba		83,65 €
	GL545288	Maleta metálica para guardar el raspador 63-315mm		169,41 €
GL545289	Maleta metálica para guardar el raspador 90-400 & 110-500mm		185,20 €	
GL545290	Maleta metálica para guardar el raspador 250-710mm		225,88 €	
 RASPADOR ROTATORIO	AC577224	RASPADOR ROTATORIO 20-63		1.075,00 €
	AC577225	RASPADOR ROTATORIO 75-180		650,00 €
	AC577226	RASPADOR ROTATORIO 180-400		1.450,00 €
	AC577228	KIT CUCHILLAS RASP. 75-180 mm		160,00 €
 HERRAMIENTA SACARREBABAS INTERNO	GL507535	Herramienta para eliminar el bordon interior soldadura a tope, set de varillas 9x1,5mm con bolsa		1.002,11 €
	GL507536	Herramienta para eliminar el bordon interior soldadura a tope Kit N°1 (90-110mm)		831,01 €
	GL507537	Herramienta para eliminar el bordon interior soldadura a tope Kit N°2 (120-140,160mm)		1.523,55 €
	GL507538	Herramienta para eliminar el bordon interior soldadura a tope Kit N°3 (160,180,200mm)		1.677,45 €
	GL507539	Herramienta para eliminar el bordon interior soldadura a tope Kit N°4 (225,250,278,315mm)		1.963,69 €
	GL507540	Herramienta para eliminar el bordon interior soldadura a tope Kit N°5 (355,400,450,500)		2.335,62 €
	GL507541	Cuchilla de repuesto para Kit N°1		131,17 €
	GL507542	Cuchilla de repuesto para Kit N°2 & 3		143,63 €
	GL507543	Cuchilla de repuesto para Kit N°4 & 5		155,39 €
	GL507550	Adaptador para cabezal del Kit N°5 de 500-630mm		278,95 €

	GL500101	Herramienta para quitar el bordon exterior de una soldadura a tope 63-125mm	593,43 €
	GL500006	Herramienta para quitar el bordon exterior de una soldadura a tope 90-140mm	605,92 €
	GL500105	Cuchilla de repuesto 63-125mm	100,65 €
	GL500029	Cuchilla de repuesto 90-400mm	111,27 €
	HERRAMIENTA SACARREBABAS INTERNO		

	GL508117	Alineador recto y angular para medidas 16-63mm	354,30 €
	ALINEADOR DN16-63		

	GL515001	Alineador recto 63-180mm	676,80 €
	GL515002	Alineador angular 63-180mm	880,33 €
	GL515003	Solo base alineador angular	210,84 €
	GL515004	Adaptador de plastico adicional (4 piezas) 180-125	127,96 €
	GL515005	Adaptador de plastico adicional (4 piezas) 129-90	116,80 €
	GL515006	Adaptador de plastico adicional (4 piezas) 125-63	120,41 €
	GL515007	Adaptador de plastico adicional (4 piezas) 180-160	127,96 €
	GL515008	Adaptador de plastico adicional (4 piezas) 180-140	127,96 €
	GL515009	Adaptador de plastico adicional (4 piezas) 180-110	127,96 €
	GL515010	Abrazadera exterior de aluminio sin adaptadores	210,84 €
	GL515011	Kit Adaptador de aluminio 63,90,125	325,37 €
	GL515012	Alineador para T 63,90,125mm	524,20 €
	GL515013	Alineador para T con adaptadores 63-180	1.402,74 €
	GL515015	Alineador 63-180mm para curvas sin adaptadores	1.972,60 €
	GL515016	Set de adaptadores de plastico adicional (4 piezas) 75-125mm	115,86 €
	GL515019	Tuerca de mariposa	29,01 €
	GL515020	Alineador tipo T 63,110,125,160,180mm con caja de madera	1.523,27 €
	GL515021	Alineador recto 75,110,125,160,180mm	1.056,43 €
	GL515022	Alineador con mordaza doble 75-110-125-160-180 con base recta y angular	1.628,92 €
	GL515023	Alineador angular 63-180mm con sierra y guia	1.039,36 €
	GL515024	Alineador recto de 1100mm 90-180mm	1.577,42 €
	GL515025	Alineador angular de 1500mm 90-180mm	1.751,15 €
	GL515027	Alineador recto 63-180mm con sierra y guia	845,14 €
	GL515028	Adaptador en T 500mm	204,47 €
	GL515029	Base recta alineador	43,44 €
	GL515030	Alineador recto 90,110,120,130,180mm	812,31 €
	GL515031	Alineador amgñiar 63,110,120,160,180 con bolsa	1.019,45 €
	GL515034	Adaptador en T 750mm	221,51 €
	GL515037	1/2 luna de adaptadores (2piezas) 125-63mm	54,54 €
	GL515038	1/2 luna de adaptadores (2piezas) 125-75mm	61,33 €
	GL515039	1/2 luna de adaptadores (2piezas) 125-90mm	54,54 €
	GL515040	1/2 luna de adaptadores (2piezas) 180-110mm	61,33 €
	GL515041	1/2 luna de adaptadores (2piezas) 180-125mm	61,33 €
	GL515042	1/2 luna de adaptadores (2piezas) 180-140mm	61,33 €
	GL515043	1/2 luna de adaptadores (2piezas) 180-160mm	61,33 €
GL515054	Alineador para T 63-180mm con sierra y guia	1.547,34 €	
GL515055	Alineador angular para 63,90,125,180mm	1.536,92 €	
GL515056	Alineador recto 63-180mm sin adaptadores	477,09 €	
GL515057	Alineador angular 63-180mm sin adaptadores	681,56 €	
GL515058	Alineador para T 63-180mm sin adaptadores	1.090,47 €	
GL515071	1 1/2 luna de adaptadores (6 piezas) 125-63mm	180,61 €	
GL515072	1 1/2 luna de adaptadores (6 piezas) 125-75mm	180,61 €	
GL515073	1 1/2 luna de adaptadores (6 piezas) 125-90mm	175,16 €	
GL515074	1 1/2 luna de adaptadores (6 piezas) 180-110mm	191,95 €	
GL515075	1 1/2 luna de adaptadores (6 piezas) 180-125mm	191,95 €	
GL515076	1 1/2 luna de adaptadores (6 piezas) 180-140mm	191,95 €	
GL515077	1 1/2 luna de adaptadores (6 piezas) 180-160mm	191,95 €	
GL516109	Sierra y guia para alineador 63,180mm	153,36 €	
ALINEADORES Y ACCESORIOS			

	GL52002S	Herramienta para la inserción de tubos. Tira + trinchete+abrazadera, recto 40-200mm	340,77 €
	GL5202S4	Herramienta para la inserción de tubos. Tira + trinchete+abrazadera doble, recto 40-200mm	665,68 €
	GL52002K	Herramienta para la inserción de tubos. Tira + trinchete+abrazadera, angular	604,23 €
	GL5202K4	Herramienta para la inserción de tubos. Tira + trinchete+abrazadera doble, angular	913,47 €
	GL52000T	Herramienta para la inserción de tubos. Tira + trinchete+rail 40-200MM	1.283,43 €
	GL520ADT	Adaptador para T 40mm	136,75 €
	GL534989	Abrazaderas adicionales 40-200mm	S/OFERTA
	GL5SC500	Herramienta para la inserción de tubos. Tira + trinchete+abrazadera, recto 160-500mm	708,00 €
	GL55002K	Herramienta para la inserción de tubos. Tira + trinchete+abrazadera, angular	1.179,20 €
	GL5502K4	Herramienta para la inserción de tubos. Tira + trinchete+abrazadera doble, angular	1.518,85 €
	GL55000T	Herramienta para la inserción de tubos. Tira + trinchete+rail 160-500MM	2.100,40 €
	GL520ADT	Adaptador para T 40mm	136,75 €
	GL512799	Abrazaderas adicionales 160-500mm	304,15 €
	GL534822	Trinchete para Titan 500	21,86 €
	ENSAMBLADOR DE TUBOS		

 <p>HERRAMIENTA DE PRESIÓN TOMAS SMPLES</p>	AC577733	Alineador para tomas simples 60-400	389,24 €

 <p>SOPORTE TUBO RODILLO AJUSTABLE</p>	AC577730	Rodillo soporta tubería hasta 355mm	189,77 €
	AC577200	Rodillo soporta tubería hasta <315mm	208,97 €

 <p>REDONDEADORES MANUALES REDONDEADORES HIDRÁULICOS</p>	GL589533	Redondeador 16-32mm	A	183,93 €
	GL589528	Redondeador 20mm	B	123,69 €
	GL589529	Redondeador 25mm	B	123,69 €
	GL589530	Redondeador 32mm	B	123,69 €
	GL589531	Redondeador 40mm	B	131,26 €
	GL589532	Redondeador 50mm	B	152,71 €
	GL589534	Redondeador articulado 63mm	C	181,18 €
	GL589535	Redondeador articulado 75mm	C	195,58 €
	GL589536	Redondeador articulado 90mm	C	274,07 €
	GL589537	Redondeador articulado 110mm	C	300,05 €
	GL589538	Redondeador articulado 125mm	C	292,09 €
	GL589539	Redondeador articulado 140mm	C	311,24 €
	GL589540	Redondeador articulado 160mm	C	329,98 €
	GL589541	Redondeador articulado 180mm	C	342,60 €
	GL589542	Redondeador partido 200mm	D	358,80 €
	GL589543	Redondeador partido 225mm	D	378,61 €
	GL589544	Redondeador partido 250mm	D	437,10 €
	GL589545	Redondeador segmentado con trinchete 315mm	E	1.553,66 €
	GL589559	Redondeador segmentado con trinchete 355mm	E	1.678,07 €
	GL589546	Redondeador segmentado con trinchete 400mm	E	1.882,23 €
	GL564029	Set adaptador reducción 400-355 (2 piezas)	F	1.462,62 €
	GL564030	Set adaptador reducción 400-315 (2 piezas)	F	1.462,62 €
	GL564031	Set adaptador reducción 215-280 (2 piezas)	F	1.462,62 €
	GL589547	Redondeador hidráulico con bomba 400mm	F	4.055,49 €
	GL564022	Set adaptador reducción 400-355 (3 piezas)	F	1.462,62 €
	GL564023	Set adaptador reducción 400-315 (3 piezas)	F	1.462,62 €
	GL589548	Redondeador hidráulico con bomba 500mm	F	4.644,24 €
	GL564024	Set adaptador reducción 500-450 (3 piezas)	F	1.663,06 €
GL564025	Set adaptador reducción 500-400 (3 piezas)	F	1.663,06 €	
GL589549	Redondeador hidráulico con bomba 630mm	F	6.742,72 €	
GL564026	Set adaptador reducción 630-560 (3 piezas)	F	2.124,21 €	
GL564027	Set adaptador reducción 630-500 (3 piezas)	F	2.124,21 €	
GL589558	Redondeador hidráulico con bomba 710mm	F	8.516,93 €	
GL564028	Set adaptador reducción 710-630 (3 piezas)	F	2.210,62 €	

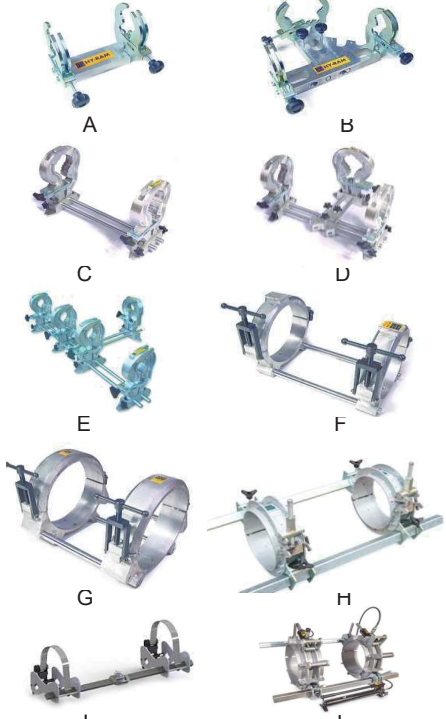
 <p>ALINEADORES</p>	GL589050	Alineador 16-63mm		209,36 €
	GL589166	Alineador articulado 45° & 90° 16-63mm		315,65 €
	GL589048	Alineador 63-180mm		547,56 €
	GL589049	Alineador articulado 45° & 90° 63-180mm		354,30 €
	GL589140	Alineador con dos abrazaderas 63-180mm		1.908,24 €
	GL589628	Alineador angular 45° & 90° con dos abrazaderas 63-180mm		S/OFERTA
	GL589093	Alineador 180-250mm		1.046,80 €
	GL530022	Adaptador 250/180 (se requieren 4 unidades)		144,94 €
	GL589094	Alineador 250-315mm		1.288,37 €
	GL530057	Adaptador 315/250 (se requieren 4 unidades)		153,73 €
	GL589551	Alineador 315		3.110,98 €
	GL589552	Alineador 355		3.517,71 €
	GL589553	Alineador 400		4.101,70 €
	GL564029	Set de adaptadores 400-355 (2 unidades)		1.462,62 €
	GL564030	Set de adaptadores 400-315 (2 unidades)		1.462,62 €
	GL564031	Set de adaptadores 315-280 (2 unidades)		1.462,62 €
	GL589629	Alineador recto 63-250mm		S/OFERTA
	GL589630	Alineador angular 63-250mm		S/OFERTA
	GL589580	Alineador recto 125-500mm		S/OFERTA
	GL589581	Alineador angular 125-500mm		S/OFERTA
	GL589582	Kit adaptador para ambos modelos		S/OFERTA
	GL589561	Alineador hidráulico + 2 bombas 400mm		8.798,41 €
	GL564022	Set adaptadores 400-355 (3 piezas)		1.462,62 €
	GL564023	Set adaptadores 400-315 (3 piezas)		1.462,62 €
	GL589562	Alineador hidráulico + 2 bombas 500mm		10.607,39 €
	GL564024	Set adaptadores 500-450 (3 piezas)		1.663,06 €
	GL564025	Set adaptadores 500-400 (3 piezas)		1.663,06 €
	GL589563	Alineador hidráulico + 2 bombas 600mm		14.537,93 €
GL564026	Set adaptadores 630-560 (3 piezas)		2.124,21 €	
GL564027	Set adaptadores 630-500 (3 piezas)		2.124,21 €	
GL589564	Alineador hidráulico + 2 bombas 710mm		19.471,60 €	
GL564028	Set adaptadores 710-630 (3 piezas)		2.210,62 €	

 <p>RECUPERADORES</p>	GL571040	Recuperador 63mm		192,10 €
	GL571047	Recuperador 75mm		158,33 €
	GL571041	Recuperador 90mm		186,91 €
	GL571042	Recuperador 110mm		198,50 €
	GL571045	Recuperador 125mm		211,20 €
	GL571053	Recuperador 140mm		215,53 €
	GL571043	Recuperador 160mm		219,16 €
	GL571048	Recuperador 180mm		210,83 €
	GL571044	Recuperador 200mm		212,30 €
	GL571049	Recuperador 225mm		219,90 €
	GL571051	Recuperador 250mm		233,42 €

 <p>ESTRANGULADOR MANUAL CAEM-50</p>	GL171087	Estrangulador manual CA-EM 50 (DN20 a DN50)		339,25 €

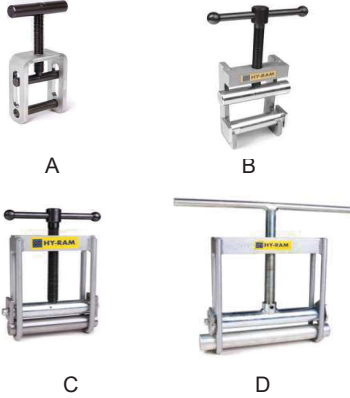
 <p>ESTRANGULADORES MANUALES</p>	GL589513	Estrangulador manual mini	A	47,51 €
	GL589053	Estrangulador manual 16-32 SDR11	B	95,00 €
	GL589052	Estrangulador manual 20-63 SDR11	B	101,47 €
	GL589241	Estrangulador manual 20-63 SDR 11 & 17	C	133,68 €
	GL5716173	Recambio cierre (pareja) 20,25,32,40,50,63 (SDR11)	C	80,52 €
	GL5716174	Recambio cierre (pareja) 20,25,32,40,50,63 (SDR17)	C	80,52 €
	GL589187	Estrangulador manual 63-125 SDR 11 & 17,6	D	322,09 €
	GL589397	Extrangulador manual 63-215 SDR21	D	S/OFERTA
	GL5716089	Recambio cierre (pareja) 63,75,90 (SDR11) & 90,110,125 (SDR17,6)	D	S/OFERTA
	GL5716168	Recambio cierre 40,50,63,75,90,125 (SDR21)	D	S/OFERTA

 <p>ESTRANGULADORES HIDRÁULICOS I NEUMATICOS</p>	GL589054	Estrangulador Hidráulico 63,75,90,125,180 (SDR11) & 125, 180 (SDR 17,6)	E	821,33 €
	GL589522	Estrangulador Hidráulico de 63 a 200 (SDR11) & de 75 a 200 (SDR 17,6)	E	S/OFERTA
	GL589492	Estrangulador manual (con bomba de mano) 180-250mm	F	9.792,63 €
	GL589493	Estrangulador neumático 180-250mm	F	14.764,27 €
	GL589073	Estrangulador hidráulico 250-400mm	G	22.131,34 €

 <p>ESTRANGULADORES HIDRÁULICOS</p>	GL171150	Estrangulador Hidraulico 30 TM E-99		S/OFERTA
	GL171158	Soporte Estrang.Hidr. 30 TM E-99		S/OFERTA
	GL171171	Puente+Gato 30 TM E-99		S/OFERTA

 <p>HERRAMIENTAS DE CORTE PARA PE</p>	AC553001	Tijeras PE 42mm		27,75 €
	AC553002	Tijeras PE 63mm		125,10 €
	AC550324	Cortador rapido 50-125 (13 mm profundidad)		661,52 €
	AC550326	Cortador rapido 110-168 (16 mm profundidad)		731,95 €
	AC552038	Guillotina 125mm		984,54 €
	AC552037	Guillotina 225mm		1.737,06 €
AC552048	Guillotina 315mm		4.326,58 €	

 <p>CORTATUBOS ROTATORIO PARA TUBERÍAS DE ACERO Y FUNDICIÓN</p>	AC552017	6"-8" LCRC 8S (159-254 mm)	S/OFERTA
	AC552018	6"-8" LCRC 8 (159-254 mm)	S/OFERTA
		10"-12" LCRC 10" (266-358 mm)	S/OFERTA
	AC552019	10"-12" LCRC 12I (266-358 mm)	S/OFERTA
	AC552020	16"-18" LCRC 16I (368-462 mm)	S/OFERTA
	AC552024	16"-18" LCRC 16S (368-462 mm)	S/OFERTA

 <p>MAQUINAS DE BANCO</p>	AC577100	Equipo banco soldar tope B160 (40-160)	3.955,00 €
	AC577101	Equipo banco soldar tope B250 (75-250)	5.100,00 €
	AC577106	Equipo Polyfusion 125 +Casq. 50/110mm	4.810,00 €
	AC577105	Equip. Polyfusion Obra 125+Casq.50/110mm	3.683,00 €

 <p>KIT POLIFUSION PARA SOLDADURA A SOCKET</p>	AC577050	KIT POLYF.16-50 +CASQ.20/25mm	UR
	AC577051	KIT POLYF.16-50 +CASQ.20/32mm	UR
	AC577052	KIT POLYF.16-63 +CASQ.20/32 +SOPORT+CAJA	UR
	AC577053	KIT POLYF.16-63 +CASQ.20/32 +2 SOP.+CAJA	UR
	AC577054	KIT POLYF.16-63 +CASQ.20/63 +2 SOP.+CAJA	UR
	AC577055	KIT POLYF.16-63 +CASQ.16-63 +2 SOP.+CAJA	UR
	AC577056	KIT POLYF.16-63 +CASQ.20/75 +2 SOP.+CAJA	UR
	AC577057	KIT POLYF.16-110+CASQ.20/110+2 SOP+2 CAJ	UR
	AC577058	KIT 16-125 (20-110)	UR

 <p>CABEZAL DE ARRASTRE EXPANSIBLE</p>	GL573003	Cabezal de arrastre expansible 55mm SDR11/17	181,49 €
	GL573004	Cabezal de arrastre expansible 63mm SDR11/17/21	166,88 €
	GL573005	Cabezal de arrastre expansible 75mm SDR11/17	217,20 €
	GL573006	Cabezal de arrastre expansible 90mm SDR11/17/21	236,85 €
	GL573007	Cabezal de arrastre expansible 110mm SDR11/17	337,55 €
	GL573008	Cabezal de arrastre expansible 125mm SDR11/17/21	381,24 €
	GL573009	Cabezal de arrastre expansible 140mm SDR11/17	645,85 €
	GL573010	Cabezal de arrastre expansible 160mm SDR11/17	677,44 €
	GL573011	Cabezal de arrastre expansible 180mm SDR11/27	784,21 €
	GL573012	Cabezal de arrastre expansible 200mm SDR11/17	902,07 €
	GL573013	Cabezal de arrastre expansible 213mm SDR11/17	UR
	GL573014	Cabezal de arrastre expansible 225mm SDR11/17	1.147,77 €
	GL573015	Cabezal de arrastre expansible 250mm SDR11/17	1.374,98 €
	GL573016	Cabezal de arrastre expansible 40mm SDR11/17	89,03 €
	GL573017	Cabezal de arrastre expansible 50mm SDR11/17	143,93 €
	GL573018	Cabezal de arrastre expansible 200mm SDR11/17	1.114,21 €
	GL573034	Cabezal de arrastre expansible 200mm SDR17,6	3.607,44 €
	GL573035	Cabezal de arrastre expansible 450mm SDR11	3.741,40 €
	GL573036	Cabezal de arrastre expansible 25mm SDR11/17	140,11 €
	GL573037	Cabezal de arrastre expansible 32mm SDR11/17	108,98 €
	GL573038	Cabezal de arrastre expansible 315mm SDR11/17	2.346,96 €
	GL573039	Cabezal de arrastre expansible 250mm SDR21	1.406,14 €
	GL573040	Cabezal de arrastre expansible 280mm SDR21	2.135,30 €
	GL573041	Cabezal de arrastre expansible 355mm SDR11/17	2.723,22 €
GL573042	Cabezal de arrastre expansible 280mm SDR11/17	1.724,32 €	
GL573043	Cabezal de arrastre expansible 213mm SDR26	2.135,30 €	
GL573044	Cabezal de arrastre expansible 315mm SDR21/26	3.358,15 €	



BATERÍAS PARA CONTADORES DE AGUA

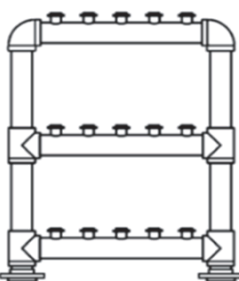

PRODUCTO	Ø	TOMAS	RAMALES	INOXIDABLE		GALVANIZADA		PPR	
				BH002		BH001		BH003	
				CODIGO	PVP 2019	CODIGO	PVP 2019	CODIGO	PVP 2019
 BATERÍA BANDERA	2"	4	2	BH0110001	256,81	BH0108001	149,67	BH0001276	139,15
	2"	6	2	BH0110002	287,64	BH0108002	163,73	BH0001277	187,66
	2"	6	3	BH0110003	366,10	BH0108003	216,76	BH0001278	274,64
	2 1/2"	8	2	BH0110004	336,42	BH0108004	229,89	BH0001279	185,10
	2 1/2"	9	3	BH0110005	418,77	BH0108005	302,11	BH0001280	262,55
	2 1/2"	10	2	BH0110006	363,62	BH0108006	251,88	BH0001281	200,66
	2 1/2"	12	2	BH0110007	397,50	BH0108007	269,36	BH0001282	210,55
	2 1/2"	12	3	BH0110008	477,05	BH0108008	300,80	BH0001283	276,27
	2 1/2"	14	2	BH0110009	423,40	BH0108009	287,24	BH0001284	229,86
	2 1/2"	15	3	BH0110010	494,92	BH0108010	333,01	BH0001285	281,42
	2 1/2"	16	2	BH0110011	458,17	BH0108011	297,67	BH0001286	254,93
	2 1/2"	18	2	BH0110012	498,13	BH0108012	347,20	BH0001287	265,33
	2 1/2"	18	3	BH0110013	618,66	BH0108013	366,82	BH0001288	312,98
	2 1/2"	20	2	BH0110014	529,50	BH0108014	348,08	BH0001289	303,83
	2 1/2"	21	3	BH0110015	591,35	BH0108015	420,05	BH0001290	358,51
	2 1/2"	22	2	BH0110016	653,34	BH0108016	422,71	BH0001291	297,43
	2 1/2"	24	2	BH0110017	651,92	BH0108017	417,79	BH0001292	317,01
	2 1/2"	24	3	BH0110018	632,64	BH0108018	434,61	BH0001293	358,26
	2 1/2"	26	2	BH0110019	690,95	BH0108019	455,95	BH0001294	313,55
	2 1/2"	27	3	BH0110020	805,45	BH0108020	504,88	BH0001295	375,78
	2 1/2"	28	2	BH0110021	730,04	BH0108021	443,11	BH0001296	348,08
	2 1/2"	30	2	BH0110022	769,08	BH0108022	450,72	BH0001297	371,53
	2 1/2"	30	3	BH0110023	731,92	BH0108023	548,19	BH0001298	383,67
	3"	33	3	BH0110024	1.036,18	BH0108024	687,14	BH0001299	563,44
	3"	36	3	BH0110025	1.051,06	BH0108025	690,39	BH0001300	586,05
	3"	39	3	BH0110026	1.084,64	BH0108026	781,87	BH0001301	580,10
	3"	42	3	BH0110027	1.138,85	BH0108027	827,02	BH0001302	668,38
	3"	45	3	BH0110028	1.342,82	BH0108028	820,08	BH0001303	651,69

PRODUCTO	Ø	TOMAS	RAMALES	BH002D		BH001D		BH003D	
				CODIGO	PVP 2019	CODIGO	PVP 2019	CODIGO	PVP 2019
 BATERÍA ENTRADA DOBLE INFERIOR	2 1/2"	8	2	BH0003371	630,30	BH0109001	268,18	BH0002825	288,48
	2 1/2"	12	2	BH0003372	662,86	BH0109000	397,93	BH0002826	294,99
	2 1/2"	18	2	BH0110101	679,68	BH0109002	326,23	BH0001604	328,58
	2 1/2"	18	3	BH0110102	720,41	BH0109003	397,87	BH0001338	393,58
	2 1/2"	20	2	BH0110103	656,96	BH0109004	369,83	BH0001605	360,75
	2 1/2"	21	3	BH0110104	732,75	BH0109005	391,24	BH0001415	414,88
	2 1/2"	22	2	BH0110105	696,04	BH0109006	487,56	BH0001395	324,84
	2 1/2"	24	2	BH0110106	735,08	BH0109007	510,39	BH0001390	387,39
	2 1/2"	24	3	BH0110107	830,07	BH0109008	439,12	BH0001416	439,50
	2 1/2"	26	2	BH0110108	774,16	BH0109009	534,77	BH0001606	440,68
	2 1/2"	27	3	BH0110109	888,65	BH0109010	451,60	BH0001417	459,43
	2 1/2"	28	2	BH0003373	813,25	BH0109011	559,18	BH0001547	528,37
	2 1/2"	30	2	BH0003374	852,28	BH0109012	582,20	BH0001607	493,43
	2 1/2"	30	3	BH0110110	947,27	BH0109013	506,52	BH0001608	451,50
	3"	33	3	BH0110111	1.290,80	BH0109014	640,70	BH0001362	644,83
	3"	36	3	BH0003375	1.347,30	BH0109015	672,06	BH0001609	673,91
	3"	39	3	BH0110112	1.419,82	BH0109016	745,79	BH0001610	820,56
	3"	42	3	BH0110113	1.492,35	BH0109017	744,95	BH0001611	761,07
	3"	45	3	BH0110114	1.564,92	BH0109018	812,24	BH0001344	792,68



BATERÍAS PARA CONTADORES DE AGUA



PRODUCTO	Ø	TOMAS	RAMALES	INOXIDABLE		GALVANIZADA		PPR	
				BH002		BH001		BH003	
				CODIGO	PVP 2019	CODIGO	PVP 2019	CODIGO	PVP 2019
 BATERÍA ENTRADA DOBLE INFERIOR	2"	4	2	BH0110029	242,99	BH0108901	189,36		CONSULTAR
	2"	6	2	BH0110030	314,18	BH0108902	185,28	BH0001387	189,59
	2"	6	3	BH0110031	377,58	BH0108903	222,23		CONSULTAR
	2 1/2"	8	2	BH0110032	346,65	BH0108904	258,67	BH0001388	215,78
	2 1/2"	9	3	BH0110033	464,61	BH0108905	344,05	BH0001389	291,86
	2 1/2"	10	2	BH0110034	430,97	BH0108906	285,57	BH0001326	238,69
	2 1/2"	12	2	BH0110035	433,31	BH0108907	318,56	BH0001394	247,64
	2 1/2"	12	3	BH0110036	521,78	BH0108908	373,85	BH0001327	312,95
	2 1/2"	14	2	BH0110037	466,35	BH0108909	367,15	BH0001397	266,18
	2 1/2"	15	3	BH0110038	588,47	BH0108910	439,36	BH0001398	319,31
	2 1/2"	16	2	BH0110039	491,95	BH0108911	363,78	BH0001399	280,65
	2 1/2"	18	2	BH0110040	544,51	BH0108912	393,15	BH0001400	290,34
	2 1/2"	18	3	BH0110041	647,05	BH0108913	360,74	BH0001393	363,08
	2 1/2"	20	2	BH0110042	583,55	BH0108914	417,90	BH0001401	309,25
	2 1/2"	21	3	BH0110043	705,66	BH0108915	406,46	BH0001403	387,98

PRICE LIST 2019

BATERÍA ENTRADA INFERIOR CENTRAL

2 1/2"	22	2	BH0110044	622,64	BH0108916	436,63	BH0001404	324,12
2 1/2"	24	2	BH0002576	661,71	BH0108917	468,64	BH0001613	238,69
2 1/2"	24	3	BH0110045	735,43	BH0108918	515,05	BH0001405	412,55
2 1/2"	26	2	BH0002577	700,75	BH0108919	496,43	BH0001406	356,20
2 1/2"	27	3	BH0110046	815,23	BH0108920	548,43	BH0001407	433,64
2 1/2"	28	2	BH0110047	739,79	BH0108921	557,60	BH0001408	370,26
2 1/2"	30	2	BH0002578	778,92	BH0108922	577,47	BH0001409	379,32
2 1/2"	30	3	BH0110048	740,21	BH0108923	592,48	BH0001410	430,13
3"	33	3	BH0110049	1.198,02	BH0108924	767,20	BH0001614	604,99
3"	36	3	BH0110050	1.254,53	BH0108925	806,31	BH0001615	646,69
3"	39	3	BH0110051	1.327,05	BH0108926	853,11	BH0001616	681,58
3"	42	3	BH0110052	1.208,21	BH0108927	883,17	BH0001617	703,19
3"	45	3	BH0110053	1.472,10	BH0108928	928,83	BH0001618	692,64



Ø	TOMAS	RAMALES	BH00501		BH00401		BH00601	
3/4"	1	1	BH0003345	231,15	BH0109502	74,95	BH0002806	65,50
1 1/2"	2	2	BH0110285	250,23	BH0109509	142,84	BH0002807	86,83
2"	3	3	BH0110288	257,89	BH0109513	191,88	BH0002808	105,69
2"	4	4	BH0110291	269,73	BH0109517	203,88	BH0001308	123,75
2"	5	5	BH0003346	360,89	BH0002500	223,07	BH0001579	136,86
2"	6	6	BH0003347	384,52	BH0002501	252,92	BH0110569	176,75
2 1/2"	7	7	BH0003348	388,41	BH0109606	262,30	BH0002809	236,64
2 1/2"	8	8	BH0003349	406,15	BH0002502	265,00	BH0002810	258,11
2 1/2"	9	9	BH0003350	426,47	BH0002503	285,30	BH0002811	279,11
2 1/2"	10	10	BH0003351	601,16	BH0002504	300,20	BH0002812	296,17



Ø	TOMAS	RAMALES	BH00503		BH00403		BH00603	
1 1/2"	2	1	BH0003359	249,14	BH0109506	93,69	BH0002820	91,99
2"	4	2	BH0003360	271,63	BH0109515	147,38	BH0001310	106,86
2"	6	3	BH0003361	365,46	BH0109605	174,12	BH0001309	146,52
2 1/2"	8	4	BH0003362	402,40	BH0002507	202,14	BH0001312	208,30
2 1/2"	10	5	BH0003363	441,78	BH0002508	237,11	BH0001580	228,34
2 1/2"	12	6	BH0003364	483,88	BH0002509	360,73	BH0002821	307,70
2 1/2"	14	7	BH0003365	580,97	BH0002510	292,42	BH0002822	331,32
2 1/2"	16	8	BH0003366	676,33	BH0002511	341,43	BH0002823	348,78
2 1/2"	18	9	BH0003367	765,96	BH0002512	384,35	BH0002824	484,60

BAHISA BATERÍAS PARA CONTADORES DE AGUA BAHISA

PRODUCTO	Ø	TOMAS	RAMALES	INOXIDABLE		GALVANIZADA		PPR	
				BH002		BH001		BH003	
				CODIGO	PVP 2019	CODIGO	PVP 2019	CODIGO	PVP 2019
	2"	4	2	-	-	BH0002543	224,11	-	-
	2"	6	2	BH0002625	673,12	BH0002544	258,45	BH0002846	266,08
	2 1/2"	8	2	BH0002626	854,90	BH0002545	276,68	BH0002847	270,48
	2 1/2"	10	2	BH0002627	948,00	BH0002546	279,71	BH0002848	282,15
	2 1/2"	12	2	BH0002628	1.032,25	BH0002547	305,45	BH0002849	288,04
	2 1/2"	14	2	BH0002629	1.100,77	BH0002548	331,51	BH0002850	332,75
	2 1/2"	16	2	BH0002630	1.271,67	BH0002549	364,06	BH0002851	342,61
	2 1/2"	18	2	BH0002631	1.373,44	BH0002550	390,68	BH0002852	362,76
	2 1/2"	20	2	BH0003390	CONSULTAR	BH0002551	417,30	-	-
	2 1/2"	22	2	BH0003391	CONSULTAR	BH0002552	452,81	-	-
	2 1/2"	24	2	BH0003392	CONSULTAR	BH0002553	467,60	-	-
	2 1/2"	26	2	BH0003393	CONSULTAR	BH0002554	497,20	-	-
	2 1/2"	28	2	BH0003394	CONSULTAR	BH0002555	526,77	-	-
	2 1/2"	30	2	BH0003395	CONSULTAR	BH0002556	538,61	-	-

PODEMOS FABRICAR CUALQUIER TIPO DE BATERIA. CONSULTE MATERIAL, DIMENSIONES, ENTRADA Y RAMALES

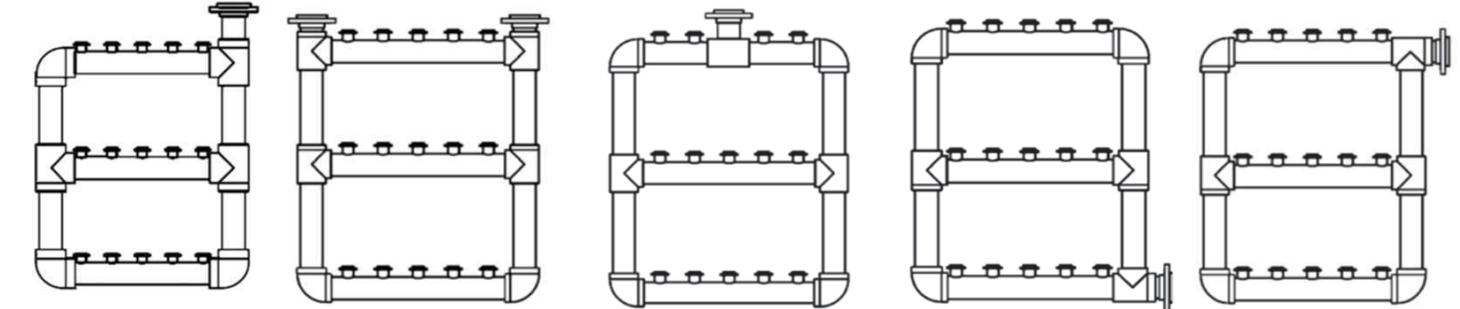

BATERÍAS Y CONTADORES DE AGUA

VALVULAS DE LATÓN PARA BATERIAS DE CONTADOR

PRODUCTO	CODIGO	MODELO	Entrada válv.	Salida válv.	Manguito s/n	Medida mang.	Paso	PVP 2019 €
----------	--------	--------	---------------	--------------	--------------	--------------	------	------------

VÁLVULAS DE ENTRADA

<p>VALVULA ASIENTO ENTRADA FIJA (INCORPORA TORNILLO + JUNTA)</p>	BH0000001	BH101	BRIDA	LL13 Izq.	Sin manguito		DN15	13,75
	BH0002862	BH101	BRIDA	LL13 Izq.	Con manguito	1/2"	DN15	16,25
	BH0002863	BH101	BRIDA	LL13 Izq.	Con manguito	LL13	DN15	16,25
	BH0002864	BH101	BRIDA	LL13 Izq.	Con manguito	3/4"	DN15	16,25
	BH0002865	BH101	BRIDA	LL13 Izq.	Con manguito	7/8"	DN15	16,25
	BH0002866	BH101	BRIDA	LL13 Izq.	Con manguito	1"	DN15	16,25
	BH0000242	BH101	BRIDA	1" Izq	Sin manguito		DN20	20,11
	BH0002867	BH101	BRIDA	1" Izq	Con manguito	LL13	DN20	22,61
	BH0002868	BH101	BRIDA	1" Izq	Con manguito	3/4"	DN20	22,61
	BH0002869	BH101	BRIDA	1" Izq	Con manguito	7/8"	DN20	22,61
BH0002870	BH101	BRIDA	1" Izq	Con manguito	1"	DN20	22,61	
<p>VÁLV. DE ASIENTO ENTRADA ORIENT. (INC TORNILLOS + JUNTA)</p>	BH0001360	BH102	BRIDA	LL13 Izq.	Sin manguito		DN15	15,20
	BH0009460	BH102RL	BRIDA	RACOR LOCO	RACOR LOCO	3/4"	DN15	CONSULTAR
		BH102RL	BRIDA	RACOR LOCO	RACOR LOCO	7/8"	DN15	CONSULTAR
	BH0002925	BH102	BRIDA	LL13 Izq.	Con manguito	1/2"	DN15	17,70
	BH0002926	BH102	BRIDA	LL13 Izq.	Con manguito	LL13	DN15	17,70
	BH0002927	BH102	BRIDA	LL13 Izq.	Con manguito	3/4"	DN15	17,70
	BH0002928	BH102	BRIDA	LL13 Izq.	Con manguito	7/8"	DN15	17,70
	BH0002929	BH102	BRIDA	LL13 Izq.	Con manguito	1"	DN15	17,70
	BH0309306	BH102	BRIDA	1" Izq	Sin manguito		DN20	22,37
	BH0002930	BH102	BRIDA	1" Izq	Con manguito	LL13	DN20	24,87
BH0002931	BH102	BRIDA	1" Izq	Con manguito	3/4"	DN20	24,87	
BH0002932	BH102	BRIDA	1" Izq	Con manguito	7/8"	DN20	24,87	
BH0002933	BH102	BRIDA	1" Izq	Con manguito	1"	DN20	24,87	
<p>VÁLVULA DE ASIENTO ENTRADA ORIENTABLE AUTOMÁTICA (INCLUYE SIST. ANTIFRAUDE)</p>	BH0309304	BH103	BRIDA	LL13 Izq.	Sin manguito		DN15	18,78
	BH0002936	BH103	BRIDA	LL13 Izq.	Con manguito	1/2"	DN15	21,28
	BH0002937	BH103	BRIDA	LL13 Izq.	Con manguito	LL13	DN15	21,28
	BH0002938	BH103	BRIDA	LL13 Izq.	Con manguito	3/4"	DN15	21,28
	BH0002939	BH103	BRIDA	LL13 Izq.	Con manguito	7/8"	DN15	21,28
	BH0002940	BH103	BRIDA	LL13 Izq.	Con manguito	1"	DN15	21,28
	BH0309307	BH103	BRIDA	1" Izq	Sin manguito		DN20	23,30
	BH0002941	BH103	BRIDA	1" Izq	Con manguito	LL13	DN20	25,80
	BH0002942	BH103	BRIDA	1" Izq	Con manguito	3/4"	DN20	25,80
	BH0002943	BH103	BRIDA	1" Izq	Con manguito	7/8"	DN20	25,80
BH0002944	BH103	BRIDA	1" Izq	Con manguito	1"	DN20	25,80	
<p>VÁLVULA DE ASIENTO ENTRADA INDIVIDUAL</p>	BH0309310	BH105	3/4"	LL13 Izq.	Sin manguito		DN15	10,56
	BH0002873	BH105	3/4"	LL13 Izq.	Con manguito	1/2"	DN15	13,06
	BH0002874	BH105	3/4"	LL13 Izq.	Con manguito	LL13	DN15	13,06
	BH0002875	BH105	3/4"	LL13 Izq.	Con manguito	3/4"	DN15	13,06
	BH0002876	BH105	3/4"	LL13 Izq.	Con manguito	7/8"	DN15	13,06
	BH0002877	BH105	3/4"	LL13 Izq.	Con manguito	1"	DN15	13,06
	BH0309311	BH105	1"	1" Izq	Sin manguito		DN20	17,07
	BH0002878	BH105	1"	1" Izq	Con manguito	LL13	DN20	19,57
	BH0002879	BH105	1"	1" Izq	Con manguito	3/4"	DN20	19,57
	BH0002880	BH105	1"	1" Izq	Con manguito	7/8"	DN20	19,57
BH0002881	BH105	1"	1" Izq	Con manguito	1"	DN20	19,57	
<p>V. DE ASIENTO ENTRADA INDIVIDUAL AUTOMÁTICA (SISTEMA ANTIFRAUDE)</p>	BH0002884	BH107	3/4"	LL13 Izq.	Sin manguito		DN15	15,47
	BH0002885	BH107	3/4"	LL13 Izq.	Con manguito	1/2"	DN15	17,97
	BH0002886	BH107	3/4"	LL13 Izq.	Con manguito	LL13	DN15	17,97
	BH0002887	BH107	3/4"	LL13 Izq.	Con manguito	3/4"	DN15	17,97
	BH0002888	BH107	3/4"	LL13 Izq.	Con manguito	7/8"	DN15	17,97
	BH0002889	BH107	3/4"	LL13 Izq.	Con manguito	1"	DN15	17,97
	BH0002890	BH107	1"	1" Izq	Sin manguito		DN20	32,47
	BH0002891	BH107	1"	1" Izq	Con manguito	LL13	DN20	34,97
	BH0002892	BH107	1"	1" Izq	Con manguito	3/4"	DN20	34,97
	BH0002893	BH107	1"	1" Izq	Con manguito	7/8"	DN20	34,97
BH0002894	BH107	1"	1" Izq	Con manguito	1"	DN20	34,97	

BATERÍAS Y CONTADORES DE AGUA

BHISA

VALVULAS DE LATÓN PARA BATERIAS DE CONTADOR

BHISA

PRODUCTO	CODIGO	MODELO	Entrada válv.	Salida válv.	Manguito s/n	Medida mang.	Paso	PVP 2019 €	
 <p>VALVULA ASIEN TO ENTRADA INDIVIDUAL</p>	BH0002908	BH106	PE20	LL13 lzq.	Sin manguito		DN15	18,58	
	BH0002909	BH106	PE20	LL13 lzq.	Con manguito	1/2"	DN15	21,08	
	BH0002910	BH106	PE20	LL13 lzq.	Con manguito	LL13	DN15	21,08	
	BH0002911	BH106	PE20	LL13 lzq.	Con manguito	3/4"	DN15	21,08	
	BH0002912	BH106	PE20	LL13 lzq.	Con manguito	7/8"	DN15	21,08	
	BH0002913	BH106	PE20	LL13 lzq.	Con manguito	1"	DN15	21,08	
	BH0001359	BH106	PE25	LL13 lzq.	Sin manguito		DN15	15,49	
	BH0002914	BH106	PE25	LL13 lzq.	Con manguito	1/2"	DN15	17,99	
	BH0002915	BH106	PE25	LL13 lzq.	Con manguito	LL13	DN15	17,99	
	BH0002916	BH106	PE25	LL13 lzq.	Con manguito	3/4"	DN15	17,99	
	BH0002917	BH106	PE25	LL13 lzq.	Con manguito	7/8"	DN15	17,99	
	BH0002918	BH106	PE25	LL13 lzq.	Con manguito	1"	DN15	17,99	
	BH0001517	BH106	PE32	1" lzq	Sin manguito		DN20	23,70	
	BH0002919	BH106	PE32	1" lzq	Con manguito	LL13	DN20	26,20	
	BH0002920	BH106	PE32	1" lzq	Con manguito	3/4"	DN20	26,20	
	BH0002921	BH106	PE32	1" lzq	Con manguito	7/8"	DN20	26,20	
	BH0002922	BH106	PE32	1" lzq	Con manguito	1"	DN20	26,20	
 <p>VALVULA ASIEN TO ENTRADA INDIVIDUAL (AUTOMATICA INDIVIDUAL CON ANTIFRAUDE)</p>	BH0309313	BH109	PE25	LL13 lzq.	Sin manguito		DN15	21,22	
	BH0002897	BH109	PE25	LL13 lzq.	Con manguito	1/2"	DN15	23,72	
	BH0002898	BH109	PE25	LL13 lzq.	Con manguito	LL13	DN15	23,72	
	BH0002899	BH109	PE25	LL13 lzq.	Con manguito	3/4"	DN15	23,72	
	BH0002900	BH109	PE25	LL13 lzq.	Con manguito	7/8"	DN15	23,72	
	BH0002901	BH109	PE25	LL13 lzq.	Con manguito	1"	DN15	23,72	
	BH0309315	BH109	PE32	1" lzq	Sin manguito		DN20	33,05	
	BH0002902	BH109	PE32	1" lzq	Con manguito	LL13	DN20	35,55	
	BH0002903	BH109	PE32	1" lzq	Con manguito	3/4"	DN20	35,55	
	BH0002904	BH109	PE32	1" lzq	Con manguito	7/8"	DN20	35,55	
	BH0002905	BH109	PE32	1" lzq	Con manguito	1"	DN20	35,55	
	 <p>VÁLVULA DE ESFERA ENTRADA ORIENTABLE</p>	BH0309404	BH111	BRIDA	LL13 lzq.	Sin manguito		DN15	23,34
		BH0003005	BH111	BRIDA	LL13 lzq.	Con manguito	1/2"	DN15	25,84
BH0003006		BH111	BRIDA	LL13 lzq.	Con manguito	LL13	DN15	25,84	
BH0003007		BH111	BRIDA	LL13 lzq.	Con manguito	3/4"	DN15	25,84	
BH0003008		BH111	BRIDA	LL13 lzq.	Con manguito	7/8"	DN15	25,84	
BH0003009		BH111	BRIDA	LL13 lzq.	Con manguito	1"	DN15	25,84	
BH0003010		BH111	BRIDA	1" lzq	Sin manguito		DN20	27,11	
BH0003011		BH111	BRIDA	1" lzq	Con manguito	LL13	DN20	29,61	
BH0003012		BH111	BRIDA	1" lzq	Con manguito	3/4"	DN20	29,61	
BH0003013		BH111	BRIDA	1" lzq	Con manguito	7/8"	DN20	29,61	
BH0003014		BH111	BRIDA	1" lzq	Con manguito	1"	DN20	29,61	
 <p>V. DE ESFERA ENTRADA INDIVIDUAL (VÁLVULA ACODADA. ESFERA CROMADA)</p>		BH0002083	BH112	3/4"	LL13 lzq.	Sin manguito		DN15	17,61
		BH0002981	BH112	3/4"	LL13 lzq.	Con manguito	1/2"	DN15	20,11
	BH0002982	BH112	3/4"	LL13 lzq.	Con manguito	LL13	DN15	20,11	
	BH0002983	BH112	3/4"	LL13 lzq.	Con manguito	3/4"	DN15	20,11	
	BH0002984	BH112	3/4"	LL13 lzq.	Con manguito	7/8"	DN15	20,11	
	BH0002985	BH112	3/4"	LL13 lzq.	Con manguito	1"	DN15	20,11	
	BH0002986	BH112	1"	1" lzq	Sin manguito		DN20	21,35	
	BH0002987	BH112	1"	1" lzq	Con manguito	LL13	DN20	23,85	
	BH0002988	BH112	1"	1" lzq	Con manguito	3/4"	DN20	23,85	
	BH0002989	BH112	1"	1" lzq	Con manguito	7/8"	DN20	23,85	
	BH0002990	BH112	1"	1" lzq	Con manguito	1"	DN20	23,85	
	 <p>V. DE ESFERA ENTRADA/SALIDA (VÁLVULA ACODADA. ESFERA CROMADA)</p>	BH0002993	BH113	PE25	LL13 lzq.	Sin manguito		DN15	23,70
		BH0002994	BH113	PE25	LL13 lzq.	Con manguito	1/2"	DN15	26,20
BH0002995		BH113	PE25	LL13 lzq.	Con manguito	LL13	DN15	26,20	
BH0002996		BH113	PE25	LL13 lzq.	Con manguito	3/4"	DN15	26,20	
BH0002997		BH113	PE25	LL13 lzq.	Con manguito	7/8"	DN15	26,20	
BH0002998		BH113	PE25	LL13 lzq.	Con manguito	1"	DN15	26,20	
BH0002070		BH113	PE32	LL13 lzq.	Sin manguito		DN15	23,18	
BH0003000		BH113	PE32	LL13 lzq.	Con manguito	1/2"	DN15	25,68	
BH0003001		BH113	PE32	LL13 lzq.	Con manguito	LL13	DN15	25,68	
BH0003002		BH113	PE32	LL13 lzq.	Con manguito	3/4"	DN15	25,68	
BH0003003		BH113	PE32	LL13 lzq.	Con manguito	7/8"	DN15	25,68	
BH0003004		BH113	PE32	LL13 lzq.	Con manguito	1"	DN15	25,68	

BATERÍAS Y CONTADORES DE AGUA

BHISA

VALVULAS DE LATÓN PARA BATERIAS DE CONTADOR

BHISA

PRODUCTO	CODIGO	MODELO	Entrada válv.	Salida válv.	Manguito s/n	Medida mang.	Paso	PVP 2019 €	
 <p>VÁLVULA DE ESFERA ENTRADA ORIENTABLE (VALV ACODADA DE ESFERA TEFLONADA Y SISTEMA ANTIFRAUDE)</p>	BH0309398	BH114	BRIDA	3/4" lzq	Sin manguito		DN20	25,54	
	BH0002968	BH114	BRIDA	3/4" lzq	Con manguito	LL13	DN20	28,04	
	BH0002969	BH114	BRIDA	3/4" lzq	Con manguito	3/4"	DN20	28,04	
	BH0002970	BH114	BRIDA	3/4" lzq	Con manguito	7/8"	DN20	28,04	
	BH0002971	BH114	BRIDA	3/4" lzq	Con manguito	1"	DN20	28,04	
 <p>VÁLVULA DE ESFERA ENTRADA ORIENTABLE (VALV ACODADA ESFERA TEFLONADA Y SISTEMA ANTIFRAUDE)</p>	BH0002049	BH114RL	BRIDA	RL 7/8"			DN20	24,17	
	BH0002049	BH114RL	BRIDA	RL 3/4"			DN20	24,17	
	BH0002049	BH114RL	BRIDA	RL 1"			DN20	24,17	
 <p>VÁLVULA DE ESFERA ENTRADA INDIVIDUAL (SISTEMA ANTIFRAUDE ESFERA TEFLONADA)</p>	BH0002953	BH115	1"	3/4" lzq	Sin manguito		DN20	20,68	
	BH0002954	BH115	1"	3/4" lzq	Con manguito	LL13	DN20	23,18	
	BH0002955	BH115	1"	3/4" lzq	Con manguito	3/4"	DN20	23,18	
	BH0002956	BH115	1"	3/4" lzq	Con manguito	7/8"	DN20	23,18	
	BH0002957	BH115	1"	3/4" lzq	Con manguito	1"	DN20	23,18	
 <p>VÁLVULA DE ESFERA ENTRADA INDIVIDUAL (SISTEMA ANTIFRAUDE. ESFERA TEFLONADA)</p>	BH0002967	BH115RL	BRIDA	RL 7/8"			DN20	24,58	
	BH0002967	BH115RL	BRIDA	RL 3/4"			DN20	24,58	
	BH0002967	BH115RL	BRIDA	RL 1"			DN20	24,58	
 <p>VÁLVULA DE ESFERA ENTRADA INDIVIDUAL PE (SISTEMA ANTIFRAUDE. ESFERA TEFLONADA)</p>	BH0003036	BH115PE	PE32	3/4" lzq	Sin manguito		DN20	29,94	
	BH0003037	BH115PE	PE32	3/4" lzq	Con manguito	LL13	DN20	32,44	
	BH0003038	BH115PE	PE32	3/4" lzq	Con manguito	3/4"	DN20	32,44	
	BH0003039	BH115PE	PE32	3/4" lzq	Con manguito	7/8"	DN20	32,44	
	BH0003040	BH115PE	PE32	3/4" lzq	Con manguito	1"	DN20	32,44	
 <p>VÁLVULA DE ESFERA ENTRADA ORIENTABLE LINEAL</p>	BH0003043	BH120	BRIDA	3/4" lzq	Sin manguito		DN20	21,96	
	BH0003044	BH120	BRIDA	3/4" lzq	Con manguito	1/2"	DN20	24,46	
	BH0003045	BH120	BRIDA	3/4" lzq	Con manguito	LL13	DN20	24,46	
	BH0003046	BH120	BRIDA	3/4" lzq	Con manguito	3/4"	DN20	24,46	
	BH0003047	BH120	BRIDA	3/4" lzq	Con manguito	7/8"	DN20	24,46	
	BH0003048	BH120	BRIDA	3/4" lzq	Con manguito	1"	DN20	24,46	

BATERÍAS Y CONTADORES DE AGUA

VALVULAS DE LATÓN PARA BATERIAS DE CONTADOR

PRODUCTO	CODIGO	MODELO	Entrada válv.	Salida válv.	Manguito s/n	Medida mang.	Paso	PVP 2019 €
 VÁLVULA DE ESFERA LINEAL	BH0003342	BH11M	H 3/4"	3/4" Izq	Sin manguito		DN20	18,77
	BH0003273	BH11M	H 3/4"	3/4" Izq	Con manguito	1/2"	DN20	21,27
	BH0003274	BH11M	H 3/4"	3/4" Izq	Con manguito	LL13	DN20	21,27
	BH0003275	BH11M	H 3/4"	3/4" Izq	Con manguito	3/4"	DN20	21,27
	BH0003276	BH11M	H 3/4"	3/4" Izq	Con manguito	7/8"	DN20	21,27
	BH0003277	BH11M	H 3/4"	3/4" Izq	Con manguito	1"	DN20	21,27
	BH0003343	BH11M	M 3/4"	3/4" Izq	Sin manguito		DN20	18,94
	BH0003278	BH11M	M 3/4"	3/4" Izq	Con manguito	1/2"	DN20	21,44
	BH0003279	BH11M	M 3/4"	3/4" Izq	Con manguito	LL13	DN20	21,44
	BH0003280	BH11M	M 3/4"	3/4" Izq	Con manguito	3/4"	DN20	21,44
BH0003281	BH11M	M 3/4"	3/4" Izq	Con manguito	7/8"	DN20	21,44	
BH0003282	BH11M	M 3/4"	3/4" Izq	Con manguito	1"	DN20	21,44	

 VÁLVULA DE ASIENTO POM ENTRADA FIJA	BH0001032	BH101 POM	BRIDA	1" Izq	Sin manguito		DN20	15,30
	BH0002947	BH101 POM	BRIDA	1" Izq	Con manguito	LL13	DN20	17,83
	BH0002948	BH101 POM	BRIDA	1" Izq	Con manguito	3/4"	DN20	17,83
	BH0002949	BH101 POM	BRIDA	1" Izq	Con manguito	7/8"	DN20	17,83
	BH0002950	BH101 POM	BRIDA	1" Izq	Con manguito	1"	DN20	17,83

VÁLVULAS DE SALIDA

 VÁLVULA DE ASIENTO DE SALIDA A ROSCA	BH0000403	BH201	LL13 Izq.	3/4"	Sin manguito		DN15	9,88
	BH0003056	BH201	LL13 Izq.	3/4"	Con manguito	1/2"	DN15	12,38
	BH0003057	BH201	LL13 Izq.	3/4"	Con manguito	LL13	DN15	12,38
	BH0003058	BH201	LL13 Izq.	3/4"	Con manguito	3/4"	DN15	12,38
	BH0003059	BH201	LL13 Izq.	3/4"	Con manguito	7/8"	DN15	12,38
	BH0003060	BH201	LL13 Izq.	3/4"	Con manguito	1"	DN15	12,38
	BH0000411	BH201	1" Izq	1"	Sin manguito		DN20	14,90
	BH0003061	BH201	1" Izq	1"	Con manguito	LL13	DN20	17,40
	BH0003062	BH201	1" Izq	1"	Con manguito	3/4"	DN20	17,40
	BH0003063	BH201	1" Izq	1"	Con manguito	7/8"	DN20	17,40
BH0003064	BH201	1" Izq	1"	Con manguito	1"	DN20	17,40	

 VÁLVULA DE ASIENTO DE SALIDA AUTOMÁTICA (CON SISTEMA ANTIFRAUDE)	BH0002060	BH203	LL13 Izq.	3/4"	Sin manguito		DN15	8,31
	BH0003067	BH203	LL13 Izq.	3/4"	Con manguito	1/2"	DN15	10,81
	BH0003068	BH203	LL13 Izq.	3/4"	Con manguito	LL13	DN15	10,81
	BH0003069	BH203	LL13 Izq.	3/4"	Con manguito	3/4"	DN15	10,81
	BH0003070	BH203	LL13 Izq.	3/4"	Con manguito	7/8"	DN15	10,81
	BH0003071	BH203	LL13 Izq.	3/4"	Con manguito	1"	DN15	10,81
	BH0003072	BH203	1" Izq	1"	Sin manguito		DN20	17,20
	BH0003073	BH203	1" Izq	1"	Con manguito	LL13	DN20	19,70
	BH0003074	BH203	1" Izq	1"	Con manguito	3/4"	DN20	19,70
	BH0003075	BH203	1" Izq	1"	Con manguito	7/8"	DN20	19,70
BH0003076	BH203	1" Izq	1"	Con manguito	1"	DN20	19,70	

 VÁLVULA DE ASIENTO DE SALIDA A PE	BH0003079	BH202	LL13 Izq.	PE25	Sin manguito		DN15	19,03
	BH0003080	BH202	LL13 Izq.	PE25	Con manguito	1/2"	DN15	21,53
	BH0003081	BH202	LL13 Izq.	PE25	Con manguito	LL13	DN15	21,53
	BH0003082	BH202	LL13 Izq.	PE25	Con manguito	3/4"	DN15	21,53
	BH0003083	BH202	LL13 Izq.	PE25	Con manguito	7/8"	DN15	21,53
	BH0003084	BH202	LL13 Izq.	PE25	Con manguito	1"	DN15	21,53
	BH0309328	BH202	1" Izq	PE32	Sin manguito		DN20	32,22
	BH0003085	BH202	1" Izq	PE32	Con manguito	LL13	DN20	34,72
	BH0003086	BH202	1" Izq	PE32	Con manguito	3/4"	DN20	34,72
	BH0003087	BH202	1" Izq	PE32	Con manguito	7/8"	DN20	34,72
BH0003088	BH202	1" Izq	PE32	Con manguito	1"	DN20	34,72	

BATERÍAS Y CONTADORES DE AGUA

VALVULAS DE LATÓN PARA BATERIAS DE CONTADOR







PRODUCTO	CODIGO	MODELO	Entrada válv.	Salida válv.	Manguito s/n	Medida mang.	Paso	PVP 2019 €
 <p>VÁLVULA DE ASIENTO DE SALIDA A ROSCA CON PURGA</p>	BH0002011	BH205	LL13 lzq.	3/4"	Sin manguito		DN15	18,23
	BH0003091	BH205	LL13 lzq.	3/4"	Con manguito	1/2"	DN15	20,73
	BH0009461	BH205	-	3/4"	RACOR LOCO	3/4"	DN15	CONSULTAR
	BH0003092	BH205	LL13 lzq.	3/4"	Con manguito	LL13	DN15	20,73
	BH0003093	BH205	LL13 lzq.	3/4"	Con manguito	3/4"	DN15	20,73
	BH0003094	BH205	LL13 lzq.	3/4"	Con manguito	7/8"	DN15	20,73
	BH0003095	BH205	LL13 lzq.	3/4"	Con manguito	1"	DN15	20,73
	BH0309321	BH205	1" lzq	1"	Sin manguito		DN20	27,36
	BH0003096	BH205	1" lzq	1"	Con manguito	LL13	DN20	29,86
	BH0003097	BH205	1" lzq	1"	Con manguito	3/4"	DN20	29,86
BH0003098	BH205	1" lzq	1"	Con manguito	7/8"	DN20	29,86	
BH0003099	BH205	1" lzq	1"	Con manguito	1"	DN20	29,86	
 <p>VÁLVULA DE ASIENTO SALIDA A PE CON PURGA</p>	BH0003102	BH206	LL13 lzq.	PE25	Sin manguito		DN15	24,25
	BH0003103	BH206	LL13 lzq.	PE25	Con manguito	1/2"	DN15	26,75
	BH0003104	BH206	LL13 lzq.	PE25	Con manguito	LL13	DN15	26,75
	BH0003105	BH206	LL13 lzq.	PE25	Con manguito	3/4"	DN15	26,75
	BH0003106	BH206	LL13 lzq.	PE25	Con manguito	7/8"	DN15	26,75
	BH0003107	BH206	LL13 lzq.	PE25	Con manguito	1"	DN15	26,75
	BH0309405	BH206	1" lzq	PE32	Sin manguito		DN20	37,35
	BH0003108	BH206	1" lzq	PE32	Con manguito	LL13	DN20	39,85
	BH0003109	BH206	1" lzq	PE32	Con manguito	3/4"	DN20	39,85
	BH0003110	BH206	1" lzq	PE32	Con manguito	7/8"	DN20	39,85
BH0003111	BH206	1" lzq	PE32	Con manguito	1"	DN20	39,85	
 <p>VÁLVULA DE ASIENTO DE SALIDA VERTICAL A ROSCA</p>	BH0309318	BH207	LL13 lzq.	3/4"	Sin manguito		DN15	14,97
	BH0003114	BH207	LL13 lzq.	3/4"	Con manguito	1/2"	DN15	17,47
	BH0003115	BH207	LL13 lzq.	3/4"	Con manguito	LL13	DN15	17,47
	BH0003116	BH207	LL13 lzq.	3/4"	Con manguito	3/4"	DN15	17,47
	BH0003117	BH207	LL13 lzq.	3/4"	Con manguito	7/8"	DN15	17,47
	BH0003118	BH207	LL13 lzq.	3/4"	Con manguito	1"	DN15	17,47
	BH0003119	BH207	1" lzq	1"	Sin manguito		DN20	22,74
	BH0003120	BH207	1" lzq	1"	Con manguito	LL13	DN20	25,24
	BH0003121	BH207	1" lzq	1"	Con manguito	3/4"	DN20	25,24
	BH0003122	BH207	1" lzq	1"	Con manguito	7/8"	DN20	25,24
	BH0003123	BH207	1" lzq	1"	Con manguito	1"	DN20	25,24
	BH0003136	BH208	LL13 lzq.	PE20	Sin manguito		DN15	19,21
	BH0003126	BH208	LL13 lzq.	PE20	Con manguito	1/2"	DN15	21,71
BH0003127	BH208	LL13 lzq.	PE20	Con manguito	LL13	DN15	21,71	
BH0003128	BH208	LL13 lzq.	PE20	Con manguito	3/4"	DN15	21,71	
BH0003129	BH208	LL13 lzq.	PE20	Con manguito	7/8"	DN15	21,71	
BH0003130	BH208	LL13 lzq.	PE20	Con manguito	1"	DN15	21,71	
BH0309406	BH208	LL13 lzq.	PE25	Sin manguito		DN15	20,58	
BH0003131	BH208	LL13 lzq.	PE25	Con manguito	1/2"	DN15	23,08	
BH0003132	BH208	LL13 lzq.	PE25	Con manguito	LL13	DN15	23,08	
BH0003133	BH208	LL13 lzq.	PE25	Con manguito	3/4"	DN15	23,08	
BH0003134	BH208	LL13 lzq.	PE25	Con manguito	7/8"	DN15	23,08	
BH0003135	BH208	LL13 lzq.	PE25	Con manguito	1"	DN15	23,08	
BH0309327	BH208	1" lzq	PE32	Sin manguito		DN20	29,61	
BH0003137	BH208	1" lzq	PE32	Con manguito	LL13	DN20	32,11	
BH0003138	BH208	1" lzq	PE32	Con manguito	3/4"	DN20	32,11	
BH0003139	BH208	1" lzq	PE32	Con manguito	7/8"	DN20	32,11	
BH0003140	BH208	1" lzq	PE32	Con manguito	1"	DN20	32,11	
 <p>VÁLVULA DE ASIENTO DE SALIDA VERTICAL A PE</p>		BH208ANT	LL13 lzq.	PE20	Sin manguito		DN15	CONSULTAR
		BH208ANT	LL13 lzq.	PE20	Con manguito	1/2"	DN15	CONSULTAR
		BH208ANT	LL13 lzq.	PE20	Con manguito	LL13	DN15	CONSULTAR
		BH208ANT	LL13 lzq.	PE20	Con manguito	3/4"	DN15	CONSULTAR
		BH208ANT	LL13 lzq.	PE20	Con manguito	7/8"	DN15	CONSULTAR
		BH208ANT	LL13 lzq.	PE20	Con manguito	1"	DN15	CONSULTAR
		BH208ANT	LL13 lzq.	PE25	Sin manguito		DN15	CONSULTAR
	BH0309408	BH208ANT	LL13 lzq.	PE25	Con manguito	1/2"	DN15	CONSULTAR
		BH208ANT	LL13 lzq.	PE25	Con manguito	LL13	DN15	CONSULTAR
		BH208ANT	LL13 lzq.	PE25	Con manguito	3/4"	DN15	CONSULTAR
<p>NOVEDAD 2019</p> <p>VÁLVULA DE ASIENTO DE SALIDA VERTICAL A PE CON ANTIRETORNO</p>		BH208ANT	LL13 lzq.	PE25	Con manguito	7/8"	DN15	CONSULTAR
		BH208ANT	LL13 lzq.	PE25	Con manguito	1"	DN15	CONSULTAR
		BH208ANT	LL13 lzq.	PE25	Con manguito		DN15	CONSULTAR

BATERÍAS Y CONTADORES DE AGUA

BHISA

VALVULAS DE LATÓN PARA BATERIAS DE CONTADOR

BHISA

PRODUCTO	CODIGO	MODELO	Entrada válv.	Salida válv.	Manguito s/n	Medida mang.	Paso	PVP 2019 €
 <p>VÁLVULA DE ASIENTO DE SALIDA ROSCADA VERTICAL CON PURGA</p>	BH0003143	BH207P	LL13 lzq.	3/4"	Sin manguito		DN15	26,85
	BH0003144	BH207P	LL13 lzq.	3/4"	Con manguito	1/2"	DN15	29,35
	BH0003145	BH207P	LL13 lzq.	3/4"	Con manguito	LL13	DN15	29,35
	BH0003146	BH207P	LL13 lzq.	3/4"	Con manguito	3/4"	DN15	29,35
	BH0003147	BH207P	LL13 lzq.	3/4"	Con manguito	7/8"	DN15	29,35
	BH0003148	BH207P	LL13 lzq.	3/4"	Con manguito	1"	DN15	29,35
	 <p>VÁLVULA DE ASIENTO DE SALIDA ROSCADA VERTICAL CON PURGA A PE</p>	BH0003156	BH208P	LL13 lzq.	PE25	Sin manguito		DN15
BH0003157		BH208P	LL13 lzq.	PE25	Con manguito	1/2"	DN15	33,54
BH0003158		BH208P	LL13 lzq.	PE25	Con manguito	LL13	DN15	33,54
BH0003159		BH208P	LL13 lzq.	PE25	Con manguito	3/4"	DN15	33,54
BH0003160		BH208P	LL13 lzq.	PE25	Con manguito	7/8"	DN15	33,54
BH0003161		BH208P	LL13 lzq.	PE25	Con manguito	1"	DN15	33,54
 <p>VÁLVULA DE ESFERA DE SALIDA CON ANTIRRETORNO</p>		BH0309407	BH209	LL13 lzq.	3/4"	Sin manguito		DN15
	BH0003187	BH209	LL13 lzq.	3/4"	Con manguito	1/2"	DN15	22,67
	BH0003188	BH209	LL13 lzq.	3/4"	Con manguito	LL13	DN15	22,67
	BH0003189	BH209	LL13 lzq.	3/4"	Con manguito	3/4"	DN15	22,67
	BH0003190	BH209	LL13 lzq.	3/4"	Con manguito	7/8"	DN15	22,67
	BH0003191	BH209	LL13 lzq.	3/4"	Con manguito	1"	DN15	22,67
	 <p>VÁLVULA DE ESFERA DE SALIDA CON ANTIRRETORNO Y PURGA</p>	BH0309400	BH213	3/4" lzq	1"	Sin manguito		DN20
BH0003181		BH213	3/4" lzq	1"	Con manguito	LL13	DN20	27,54
BH0003182		BH213	3/4" lzq	1"	Con manguito	3/4"	DN20	27,54
BH0003183		BH213	3/4" lzq	1"	Con manguito	7/8"	DN20	27,54
BH0003184		BH213	3/4" lzq	1"	Con manguito	1"	DN20	27,54
 <p>VÁLVULA DE ESFERA DE SALIDA CON ANTIRRETORNO Y PURGA A PE</p>		BH0003266	BH213PE	3/4" lzq	PE32	Sin manguito		DN20
	BH0003267	BH213PE	3/4" lzq	PE32	Con manguito	LL13	DN20	37,99
	BH0003268	BH213PE	3/4" lzq	PE32	Con manguito	3/4"	DN20	37,99
	BH0003269	BH213PE	3/4" lzq	PE32	Con manguito	7/8"	DN20	37,99
	BH0003270	BH213PE	3/4" lzq	PE32	Con manguito	1"	DN20	37,99
	 <p>VÁLVULA DE ESFERA DE SALIDA CON ANTIRRETORNO Y PURGA CON RACORD LOCO</p>	BH0002050	BH213RL	BRIDA	RL 7/8"			DN20
BH0002050		BH213RL	BRIDA	RL 3/4"			DN20	23,81
BH0002050		BH213RL	BRIDA	RL 1"			DN20	23,81

BATERÍAS Y CONTADORES DE AGUA

VALVULAS DE LATÓN PARA BATERIAS DE CONTADOR

PRODUCTO	CODIGO	MODELO	Entrada válv.	Salida válv.	Manguito s/n	Medida mang.	Paso	PVP 2019 €
 <p>VÁLVULA DE ASIENTO DE SALIDA A ROSCA EN POM</p>	BH0001033	BH201POM	1" Izq	1"	Sin manguito		DN20	10,20
	BH0003169	BH201POM	1" Izq	1"	Con manguito	LL13	DN20	12,92
	BH0003170	BH201POM	1" Izq	1"	Con manguito	3/4"	DN20	12,92
	BH0003171	BH201POM	1" Izq	1"	Con manguito	7/8"	DN20	12,92
	BH0003172	BH201POM	1" Izq	1"	Con manguito	1"	DN20	12,92
	BH0001034	BH205POM	1" Izq	1"	Sin manguito		DN20	20,23
 <p>VÁLVULA DE ASIENTO DE SALIDA A ROSCA EN POM. CON PURGA</p>	BH0003175	BH205POM	1" Izq	1"	Con manguito	LL13	DN20	20,23
	BH0003176	BH205POM	1" Izq	1"	Con manguito	3/4"	DN20	20,23
	BH0003177	BH205POM	1" Izq	1"	Con manguito	7/8"	DN20	20,23
	BH0003178	BH205POM	1" Izq	1"	Con manguito	1"	DN20	20,23



BATERÍAS Y CONTADORES DE AGUA

BAHISA



VALVULAS LINEALES LATON



BAHISA

PRODUCTO	CODIGO	MODELO	Entrada válv.	Salida válv.	Manguito s/n	Medida mang.	Paso	PVP 2019 €
 <p>VÁLVULA DE ESFERA PARA ACOMETIDA EN LÍNEA (ROSCA)</p>	BH0309366	BH10	1/2"	HEMBRA	HEMBRA	Cuadradillo	DN15	17,26
	BH0309380	BH10	1/2"	HEMBRA	HEMBRA	Manecilla	DN15	17,26
	BH0309367	BH10	1/2"	MACHO	HEMBRA	Cuadradillo	DN15	17,26
	BH0003319	BH10	1/2"	MACHO	HEMBRA	Manecilla	DN15	17,26
	BH0309368	BH10	1/2"	MACHO	MACHO	Cuadradillo	DN15	17,26
	BH0003320	BH10	1/2"	MACHO	MACHO	Manecilla	DN15	17,26
	BH0000592	BH11	3/4"	HEMBRA	HEMBRA	Cuadradillo	DN20	18,39
	BH0003321	BH11	3/4"	HEMBRA	HEMBRA	Manecilla	DN20	18,39
	BH0309371	BH11	3/4"	MACHO	HEMBRA	Cuadradillo	DN20	18,39
	BH0003322	BH11	3/4"	MACHO	HEMBRA	Manecilla	DN20	18,39
	BH0000620	BH11	3/4"	MACHO	MACHO	Cuadradillo	DN20	18,39
	BH0003323	BH11	3/4"	MACHO	MACHO	Manecilla	DN20	18,39
	BH0000593	BH12	1"	HEMBRA	HEMBRA	Cuadradillo	DN25	24,81
	BH0003324	BH12	1"	HEMBRA	HEMBRA	Manecilla	DN25	24,81
	BH0003325	BH12	1"	MACHO	HEMBRA	Cuadradillo	DN25	24,81
	BH0003326	BH12	1"	MACHO	HEMBRA	Manecilla	DN25	24,81
BH0309373	BH12	1"	MACHO	MACHO	Cuadradillo	DN25	24,81	
BH0003327	BH12	1"	MACHO	MACHO	Manecilla	DN25	24,81	
 <p>VÁLVULA DE ESFERA PARA ACOMETIDA EN LÍNEA (ROSCA-PE)</p>	BH0002131	BH24C	1.1/2"	HEMBRA	HEMBRA	Cuadradillo	DN40	42,40
	BH0002132	BH24C	1.1/2"	MACHO	HEMBRA	Cuadradillo	DN40	48,02
	BH0309374	BH25C	2"	HEMBRA	HEMBRA	Cuadradillo	DN50	62,91
	BH0002133	BH25C	2"	MACHO	HEMBRA	Cuadradillo	DN50	71,55
	BH0003328	BH13C	1/2"	HEMBRA	PE20	Cuadradillo	DN15	20,91
	BH0003329	BH13C	1/2"	MACHO	PE20	Cuadradillo	DN15	22,95
	BH0001356	BH14C	3/4"	HEMBRA	PE25	Cuadradillo	DN20	21,80
	BH0003330	BH14C	3/4"	MACHO	PE25	Cuadradillo	DN20	24,03
	BH0001357	BH15C	1"	HEMBRA	PE32	Cuadradillo	DN25	32,11
	BH0003331	BH15C	1"	MACHO	PE32	Cuadradillo	DN25	29,66
 <p>VÁLVULA DE ESFERA PARA ACOMETIDA EN LÍNEA (PE-PE)</p>	BH0001986	BH16C		PE20	PE20	Cuadradillo	DN15	25,76
	BH0001984	BH17C		PE25	PE25	Cuadradillo	DN20	25,51
	BH0001358	BH18C		PE32	PE32	Cuadradillo	DN25	33,27

 <p>NOVEDAD CON SISTEMA ANTIFRAUDE</p>  <p>VÁLVULA DE ESFERA PARA ACOMETIDA EN LÍNEA (ROSCA)</p>		BH10	1/2"	HEMBRA	HEMBRA	Cuadradillo	DN15	18,31
		BH10	1/2"	MACHO	HEMBRA	Cuadradillo	DN15	18,31
		BH10	1/2"	MACHO	MACHO	Cuadradillo	DN15	18,31
		BH11	3/4"	HEMBRA	HEMBRA	Cuadradillo	DN20	18,31
		BH11	3/4"	MACHO	HEMBRA	Cuadradillo	DN20	19,43
		BH11	3/4"	MACHO	MACHO	Cuadradillo	DN20	19,43
		BH12	1"	HEMBRA	HEMBRA	Cuadradillo	DN25	25,87
		BH12	1"	MACHO	HEMBRA	Cuadradillo	DN25	25,87
	BH12	1"	MACHO	MACHO	Cuadradillo	DN25	25,87	

BATERÍAS Y CONTADORES DE AGUA

 <p>NOVEDAD CON SISTEMA ANTIFRAUDE</p>  <p>VÁLVULA DE ESFERA PARA ACOMETIDA EN LÍNEA (ROSCA-PE)</p>								
		BH13C	1/2"	HEMBRA	PE20	Cuadradillo	DN15	21,96
		BH13C	1/2"	MACHO	PE20	Cuadradillo	DN15	24,01
		BH14C	3/4"	HEMBRA	PE25	Cuadradillo	DN20	22,85
		BH14C	3/4"	MACHO	PE25	Cuadradillo	DN20	25,08
		BH15C	1"	HEMBRA	PE32	Cuadradillo	DN25	33,18
		BH15C	1"	MACHO	PE32	Cuadradillo	DN25	30,72

 <p>NOVEDAD CON SISTEMA ANTIFRAUDE</p>  <p>VÁLVULA DE ESFERA PARA ACOMETIDA EN LÍNEA (PE-PE) ANTIFRAUDE</p>								
	BH0003398	BH16C		PE20	PE20	Cuadradillo	DN15	26,81
	BH0003399	BH17C		PE25	PE25	Cuadradillo	DN20	26,57
	BH0003400	BH18C		PE32	PE32	Cuadradillo	DN25	34,33

NOVEDAD 2019								
 <p>VÁLVULA DE ESFERA ROSCADA ACODADA PARA ACOMETIDA A PE</p>								
	BH0009445			3/4" M	PE25	Cuadradillo	DN20	CONSULTAR
	BH0009446			1" M	PE32	Cuadradillo	DN20	CONSULTAR
	BH0009125			1 1/4" M	PE40	Cuadradillo	DN32	CONSULTAR

BATERÍAS Y CONTADORES DE AGUA

BAHISA

ACCESORIOS BATERIAS

BAHISA

PRODUCTO	CODIGO	MODELO	Entrada válv.	Salida válv.	PASO		PVP 2019 €		
 <p>MANGUITO</p>	BH0002098	BH401	LL13	1/2"	DN15		2,57		
	BH0000354	BH401	LL13	LL13	DN15		2,55		
	BH0000355	BH401	LL13	3/4"	DN15		2,46		
	BH0000358	BH401	LL13	7/8"	DN15		2,73		
	BH0000359	BH401	LL13	1"	DN15		3,14		
	BH0001355	BH401	3/4"	LL13	DN20		2,36		
	BH0000594	BH401	3/4"	3/4"	DN20		2,51		
	BH0002028	BH401	3/4"	7/8"	DN20		3,05		
	BH0000572	BH401	3/4"	1"	DN20		2,79		
	BH0000360	BH401	1"	LL13	DN20		2,98		
	BH0000412	BH401	1"	3/4"	DN20		2,88		
	BH0000413	BH401	1"	7/8"	DN20		2,83		
	BH0000414	BH401	1"	1"	DN20		3,00		
 <p>MANGUITO RACORD LOCO</p>	BH0309105	BH425	LL13	3/4"	DN15		6,76		
	BH0309106	BH425	LL13	7/8"	DN15		6,99		
	BH0001520	BH425	LL13	1"	DN15		6,55		
	BH0309109	BH425	3/4"	7/8"	DN20		7,56		
	BH0309108	BH425	3/4"	1"	DN20		8,23		
<p>MANGUITO CIEGO</p>	BH0000611		LL13	---	DN15		6,10		
 <p>PURGA VÁLVULA SALIDA</p>	BH0003250	BH408	DN15			1	6,35		
	BH0003251	BH408	DN20				1	9,08	
 <p>TAPÓN OBTURADOR</p>	BH0003252	BH409	DN15				1	6,99	
	BH0003253	BH409	DN20					1	8,41
	BH0003254	BH410	DN15/ DN20					1	1,97
	BH0002153		DN15					1	6,14
	BH0002154		DN20					1	8,86
 <p>MONTURA MANUAL (PISONCILLO METALICO)</p>	BH0001050	BH418	DN15				6	10,45	
 <p>MONTURA MANUAL (INCLUYE PISONCILLO)</p>	BH0000014	BH403	DN15				6	5,27	
	BH0000243	BH403	DN20					6	11,54
	BH0001052	BH403POM	DN20					6	7,89



MONTURA VÁLVULA SALIDA VERTICAL

BH0000270	BH439	DN15		6	8,98
BH00003259	BH439	DN20		6	15,71



PISONCILLO

BH0000009	BH404	DN15	Caucho	100	0,28
BH0000051	BH405	DN15	Alma Metalica	50	2,60
BH0000245	BH405	DN20	Metálico con asiento de Caucho	50	2,57



BH406/BH407

JUNTA, TORNILLO Y ARANDELA

BH0000012	BH406 Junta	DN15/DN20	Junta	25	0,36
BH00002146	BH407 tornillo	DN15/DN20	Tornillo válvula de entrada	50	0,28
BH0000437	Arandela	DN15/DN20	Arandela Válvula de entrada	50	0,07



TAPÓN CON EJE VALVULA ENTRADA AUTOMATICA

BH00003257	BH421	DN15		1	4,00
BH00003258	BH421	DN20		1	10,42

CODIGO	MODELO	Largo	Salida	Paso	Pedido mínimo	PVP 2019 €
--------	--------	-------	--------	------	---------------	------------



JUNTA DE MANGUITO

BH0000053	BH413	LL13	LL13		50	0,16
BH0000053	BH413	LL13	1/2"		50	0,16
BH0000054	BH413	LL13	3/4"		50	0,25
BH0000055	BH413	LL13	7/8"		50	0,24
BH0000056	BH413	LL13	1"		50	0,27
BH0000056	BH413	1"	3/4"		50	0,27
BH0000060	BH413	1"	7/8"		50	0,26
BH0000060	BH413	1"	1"		50	0,26
BH0000061	BH413	1"	1 1/4"		50	0,33
BH0000062	BH413	1"	1 1/2"		50	0,33
BH0000054	BH413	3/4"	LL13		50	0,25
BH0001049	BH413	3/4"	3/4"		50	0,23
BH0000064	BH413	3/4"	7/8"		50	0,25
BH0000056	BH413	3/4"	1"		50	0,27



KIT BRIDA ROSCADA COMPATIBLE DIN 2573 (TORNILOS + JUNTA INC)

BH0110236	BH009	1 1/2"			1	17,05
BH0001348	BH009	2"			1	21,23
BH0001349	BH009	2 1/2"			1	23,66
BH0001350	BH009	3"			1	28,20







RECAMBIO JUNTA BRIDA DIN 2573









BH0110222	BH019	1 1/2"			1	1,19
BH0001507	BH019	2"			1	1,72
BH0000438	BH019	2 1/2"			1	2,45
BH0001509	BH019	3"			1	2,97



KIT BRIDA ROSCADA COMPATIBLE DIN 2566 BRIDA AGBAR

BH0002025		1 1/4"			1	26,37
BH0002021		1 1/2"			1	29,60
BH0002009		2"			1	36,46
BH0002022		2 1/2"			1	47,77
BH0002023		3"			1	66,69
BH0002024		4"			1	74,49

 <p>KIT BRIDA ROSCADA BANA 60</p>	CODIGO	MODELO	Largo	Salida	Paso	Pedido mínimo	PVP 2019 €
	BH0110230	BH010	2 1/2"			1	50,07 €
	BH0110231	BH010	3"			1	59,11 €
	BH0110232	BH010	4"			1	67,13 €
<p>RECAMBIO JUNTA BRIDA BANA 60</p>	BH0000438	BH017	2 1/2"			1	2,45 €
	BH0001509	BH017	3"			1	2,97 €
	BH0110221	BH017	4"			1	3,86 €
 <p>KIT Y JUNTAS BRIDA BARCO</p>	BH0110233	BH011 KIT	1 1/2"			1	23,49 €
	BH0110234	BH011 KIT	2"			1	25,17 €
	BH0110222	BH018 JUNTA	1 1/2" y 2"			1	1,19 €
 <p>VÁLVULA RETENCIÓN</p>	BH0001504		2"			1	193,33 €
	BH0001505		2 1/2"			1	214,46 €
	BH0001506		3"			1	226,45 €
 <p>VÁLVULA RETENCIÓN TIPO YORK</p>	BH0003218	3120	1/2"			1	6,31 €
	BH0003219	3120	3/4"			1	10,81 €
	BH0003220	3120	1"			1	15,19 €
	BH0003221	3120	1 1/4"			1	20,79 €
	BH0003222	3120	1 1/2"			1	27,69 €
	BH0003223	3120	2"			1	40,79 €
	BH0003224	3120	2 1/2"			1	94,69 €
	BH0003225	3120	3"			1	122,81 €
BH0003226	3120	4"			1	177,17 €	
<p>CUADRO CLASIFICACIÓN</p> 	CODIGO	MODELO	Largo	Salida	Paso	Pedido mínimo	PVP 2019 €
	BH0110251	BH006	7	3		1	11,80 €
BH0110252	BH006	15	3		1	15,60 €	
 <p>CAÑO LIBRE</p>	CODIGO	MODELO	Largo	Salida	Paso	Pedido mínimo	PVP 2019 €
	BH0110207	BH055	3/4"	3/4"			4,65 €
	BH0110208	BH055	7/8"	3/4"			7,36 €
BH0110209	BH055	1"	1"			5,93 €	
 <p>CAÑO CIEGO</p>	BH0110204	BH039	LL13	LL13			4,89 €
	BH0002213	BH039	3/4"	3/4"			10,23 €
	BH0110205	BH039	1"	1"			8,24 €
<p>CAJA ANTIFRAUDE ESTÁNDAR.</p> 	CODIGO	MODELO	Largo	Salida	Paso	Pedido mínimo	PVP 2019 €
	BH0311052	BH426	Plástico blanco opaco			200	CONSULTAR
	BH0311051	BH426	Plástico blanco opaco.Con texto legal			5000	CONSULTAR
	BH0002012	BH426	Plástico blanco opaco. Personalizado			5000	CONSULTAR



 <p>PRECINTO DE ALUMINIO</p>	<table border="1"> <tr> <td>BH0311049</td> <td></td> <td></td> <td></td> <td></td> <td>400</td> <td>CONSULTAR</td> </tr> </table>	BH0311049					400	CONSULTAR							
BH0311049					400	CONSULTAR									
 <p>CABLE METÁLICO CON RECUBRIMIENTO PLÁSTICO</p>	<table border="1"> <tr> <td>BH0311047</td> <td></td> <td>400 mts</td> <td></td> <td></td> <td>1</td> <td>CONSULTAR</td> </tr> </table>	BH0311047		400 mts			1	CONSULTAR							
BH0311047		400 mts			1	CONSULTAR									
 <p>ALICATE PRECINTAR CON FUNDA</p>	<table border="1"> <tr> <td>BH0311046</td> <td>BH431</td> <td></td> <td></td> <td></td> <td>1</td> <td>CONSULTAR</td> </tr> </table>	BH0311046	BH431				1	CONSULTAR							
BH0311046	BH431				1	CONSULTAR									
 <p>CARTERA PORTA-PRECINTO EN CUERO</p>	<table border="1"> <tr> <td>BH0311048</td> <td></td> <td></td> <td></td> <td></td> <td>1</td> <td>CONSULTAR</td> </tr> </table>	BH0311048					1	CONSULTAR							
BH0311048					1	CONSULTAR									
		<table border="1"> <thead> <tr> <th>CODIGO</th> <th>MODELO</th> <th>Largo</th> <th>Salida</th> <th>Paso</th> <th>Pedido mínimo</th> <th>PVP 2019 €</th> </tr> </thead> </table>	CODIGO	MODELO	Largo	Salida	Paso	Pedido mínimo	PVP 2019 €						
CODIGO	MODELO	Largo	Salida	Paso	Pedido mínimo	PVP 2019 €									
 <p>FLEXO CONEXIÓN CONTADORES</p>	<table border="1"> <tr> <td>BH0311039</td> <td>BH014</td> <td>L-500</td> <td>3/4" Inox</td> <td>M -H</td> <td>1</td> <td>12,58</td> </tr> <tr> <td>BH0311037</td> <td>BH014</td> <td>L-500</td> <td>1" Inox</td> <td>M -H</td> <td>1</td> <td>21,50</td> </tr> </table>	BH0311039	BH014	L-500	3/4" Inox	M -H	1	12,58	BH0311037	BH014	L-500	1" Inox	M -H	1	21,50
BH0311039	BH014	L-500	3/4" Inox	M -H	1	12,58									
BH0311037	BH014	L-500	1" Inox	M -H	1	21,50									
 <p>PIPA STD</p>	<table border="1"> <tr> <td>BH0110248</td> <td>BH008</td> <td></td> <td>Galvanizada / Galvanizada / Galvanizada</td> <td></td> <td>1</td> <td>87,40</td> </tr> <tr> <td>BH0110249</td> <td>BH030</td> <td></td> <td>Stainless / Inoxidable / Inox</td> <td></td> <td>1</td> <td>145,74</td> </tr> </table>	BH0110248	BH008		Galvanizada / Galvanizada / Galvanizada		1	87,40	BH0110249	BH030		Stainless / Inoxidable / Inox		1	145,74
BH0110248	BH008		Galvanizada / Galvanizada / Galvanizada		1	87,40									
BH0110249	BH030		Stainless / Inoxidable / Inox		1	145,74									
 <p>PLETINA CIEGA</p>	<table border="1"> <tr> <td>BH0110227</td> <td>BH007</td> <td></td> <td></td> <td></td> <td>1</td> <td>4,98</td> </tr> </table>	BH0110227	BH007				1	4,98							
BH0110227	BH007				1	4,98									
 <p>GANCHO PARA BATERIA INOX/GALVA</p>	<table border="1"> <tr> <td>BH0110206</td> <td>-</td> <td></td> <td></td> <td></td> <td>1</td> <td>1,46</td> </tr> </table>	BH0110206	-				1	1,46							
BH0110206	-				1	1,46									
 <p>GANCHO PARA BATERIA PPR/PE</p>	<table border="1"> <tr> <td>BH0001347</td> <td>-</td> <td></td> <td></td> <td></td> <td>1</td> <td>2,77</td> </tr> </table>	BH0001347	-				1	2,77							
BH0001347	-				1	2,77									

BATERÍAS Y CONTADORES DE AGUA

BaHISA

CAJAS CONTADORES

BaHISA

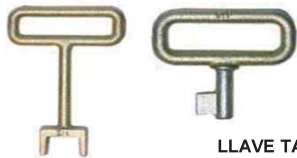
PRODUCTO	CODIGO	MODELO	Conexión	PASO				PVP 2019 €
 <p>TRAMPILLON PARA CONTADOR CON VALVULA DE CORTE (contador no incluido)</p>	BH0106001	BH9003	3/4"	DN15				144,83
	BH0003312	BH9003	PE25	DN15				154,57
 <p>TRAMPILLON PARA CONTADOR CON DOBLE VALVULA DE CORTE</p>	BH0106101	BH9005	3/4"	DN15				142,80
	BH0003314	BH9005	PE25	DN15				184,71
 <p>TRAMPILLÓN COMPACTO PARA VALVULA CORTE</p>	BH0106141	BH9001	3/4"	DN15				81,66
	BH0003316	BH9001	PE25	DN15				99,22
 <p>LLAVE TAPA</p>	BH0106214	BH9015		Llave tapa				1,27
	BH0106215	BH9016	14 mm.	Llave válvula de cuadrado				0,41
	BH0106216	BH9016	30 mm.	Llave válvula de cuadrado				3,34

PRODUCTO	CODIGO	MODELO	Ancho	Alto	Profundo	Cierre	Opciones	PVP 2019 €
<p>ARMARIO PARA CONTADOR (poliestere con fibra de vidrio)</p>	BH0311006	BH020	431	317	181	Allen		50,51
	BH0311001	BH020	431	317	181	Triangular		44,38
	BH0311002	BH021	431	317	181	Allen	Aislante puerta	76,74
	BH0311003	BH021	431	317	181	Triangular	Aislante puerta	77,14
	BH0311013	BH023	431	317	181	Allen	Aislante total	118,11
	BH0311015	BH023	431	317	181	Triangular	Aislante total	132,32
	BH0311010	BH035	431	317	181	Allen		64,93
	BH0311009	BH035	431	317	181	Triangular		52,74
	BH0311005	BH037	431	317	181	Allen	Aislante puerta	86,72
	BH0311004	BH037	431	317	181	Triangular	Aislante puerta	86,16
	BH0002037	BH050	431	317	181	Allen	Mirilla	70,89
BH0311011	BH050	431	317	181	Triangular	Mirilla	58,40	
<p>ARMARIO PARA CONTADOR (poliestere con fibra de vidrio)</p>	BH0311021	BH026	431	317		Allen		45,76
	BH0311019	BH026	431	317		Triangular		40,65
<p>ARMARIO PARA CONTADOR (poliestere con fibra de vidrio) (contador no incluido)</p>	BH0003379	BH035	431	317	181	Allen	BH106 + BH208	112,04
	BH0003304	BH035	431	317	181	Allen	BH112 + BH209	109,57
	BH0003305	BH035	431	317	181	Allen	BH113 + BH113	131,50
	BH0003306	BH035	431	317	181	Allen	BH113 + BH113	108,06
	BH0003307	BH035	431	317	181	Allen	BH113 + BH113	111,50
	BH0003308	BH035	431	317	181	Allen	BH115 + BH213	111,98
	BH0003309	BH035	431	317	181	Allen	BH115 + BH213	102,29
	BH0003310	BH035	431	317	181	Allen	BH115 + BH213	130,35
	BH0003311	BH035	431	317	181	Allen	BH115 + BH213	133,75
	<p>ARMARIO PARA CONTADOR (poliestere con fibra de vidrio) (contador no incluido)</p>	BH0310990	BH052	536	516	227	2	
BH0310991		BH052	536	516	227	3		260,73
BH0311025		BH022	500	1000	300			836,29
<p>ARMARIO PARA CONTADOR Tipo CANAL DE ISABEL II</p>		A-1	465	335	165			CONSULTAR
		A-2	710	570	220			CONSULTAR
		A-3	910	690	340			CONSULTAR
<p>SOLUCIONES EN EQUIPAMIENTO DE ARMARIOS</p>	NOVEDAD 2019							
	<p>ADAPTACIONES A MEDIDA PARA INSERTAR EN ARMARIOS SEGÚN NECESIDAD CON:</p> <p>BATERIA VALVULAS ELECTROVALVULAS LATIGUILLOS CONTADORES, ETC</p> <p>NOS ADAPTAMOS PARA DARLES UNA SOLUCIÓN A MEDIDA</p>							

ACCESORIOS DE OBTURACIÓN

BALONES Y PISTONES PARA LA OBTURACIÓN DE TUBERÍAS

PRODUCTO	CODIGO	MODELO	PVP 2019
 <p style="text-align: center;">BALONES OBTURADORES SIMPLE</p>	AC581000	50 SIMPLE	85,39 €
	AC581001	65 SIMPLE	85,39 €
	AC581002	80 SIMPLE	85,83 €
	AC581003	100 SIMPLE	93,25 €
	AC581004	125 SIMPLE	95,20 €
	AC581005	150 SIMPLE	102,62 €
	AC581006	200 SIMPLE	112,32 €
	AC581007	250 SIMPLE	143,01 €
	AC581008	300 SIMPLE	147,45 €
	AC581014	450 SIMPLE	316,66 €
	AC581010	400 SIMPLE	306,57 €
	AC581011	500 SIMPLE	449,49 €
	AC581012	600 SIMPLE	657,27 €
	AC581013	700 SIMPLE	865,77 €
AC581015	800 SIMPLE	1.236,43 €	
AC581016	900 SIMPLE	1.271,61 €	
 <p style="text-align: center;">BALONES OBTURADORES COMPLETO</p>	AC581018	50 TS	106,92 €
	AC581021	65 TS	107,09 €
	AC581022	80 TS	107,33 €
	AC581023	100 TS	114,80 €
	AC581024	125 TS	116,74 €
	AC581025	150 TS	124,14 €
	AC581026	200 TS	133,85 €
	AC581027	250 TS	164,53 €
	AC581028	300 TS	169,32 €
	AC581029	350 TS	214,31 €
	AC581030	400 TS	320,22 €
	AC581034	450 TS	330,30 €
	AC581031	500 TS	463,15 €
	AC581032	600 TS	695,98 €
	AC581019	650 TS	695,98 €
	AC581033	700 TS	902,36 €
	AC581020	750 TS	963,47 €
AC581035	800 TS	1.273,03 €	
AC581036	900 TS	1.291,36 €	
AC581037	1000 TS	1.521,50 €	
 <p style="text-align: center;">BALONES OBTURADORES FLEXIBLES</p>	AC581051	50 TF	CONSULTAR
	AC581052	65 TF	CONSULTAR
	AC581053	80 TF	CONSULTAR
	AC581054	100 TF	CONSULTAR
	AC581055	125 TF	CONSULTAR
	AC581056	150 TF	CONSULTAR
	AC581058	200 TF	CONSULTAR
	AC581059	250 TF	CONSULTAR
	AC581060	300 TF	CONSULTAR
	AC581061	350 TF	CONSULTAR
	AC581062	400 TF	CONSULTAR
	AC581063	450 TF	CONSULTAR
AC581064	500 TF	CONSULTAR	
AC581066	600 TF	CONSULTAR	
AC581068	800 TF	CONSULTAR	
 <p style="text-align: center;">PISTÓN OBTURADOR MULTIDIÁMETRO</p>	AC581464	MTD 40-70	246,15 €
	AC581465	MTD 70-150	319,16 €
	AC581467	MTD 100-200	374,42 €
	AC581468	MTD 150-300	563,87 €
	AC581469	MTD 200-400	611,23 €
	AC581470	MTD 300-525	891,45 €
	AC581471	MTD 350-600	901,31 €
	AC581472	MTD 375-750	1.485,45 €
	AC581473	MTD 500-800	1.890,00 €
	AC581474	MTD 500-1000	1.937,36 €
	AC581475	MTD 600-1200	3.033,80 €
	AC581476	MTD 750-1500	5.569,62 €
	AC581504	MTD/S 100-200	832,25 €
	AC581505	MTD/S 150-300	1.031,57 €
	AC581506	MTD/S 200-400	1.157,86 €
	AC581507	MTD/S 300-525	1.509,13 €
	AC581508	MTD/S 350-600	1.996,56 €
AC581509	MTD/S 375-750	2.781,97 €	
AC581510	MTD/S 500-800	3.259,53 €	
AC581511	MTD/S 500-1000	3.360,17 €	
AC581512	MTD/S 600-1200	4.756,58 €	
AC581513	MTD/S 750-1500	7.398,96 €	

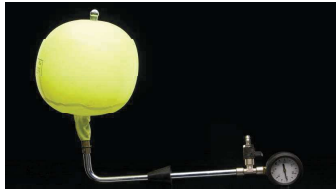

BALONES OBTURADORES PARA PE

AC581102	3"- 80 mm SIMPLE	42,18 €
AC581103	4"- 100 mm SIMPLE	43,06 €
AC581105	6"- 150 mm SIMPLE	46,70 €
AC581106	8"- 200 mm SIMPLE	57,17 €
AC581107	10"- 250 mm SIMPLE	65,36 €
AC581108	12"- 300 mm SIMPLE	68,73 €
AC181102	3"X 80mm COMPLETO	106,97 €
AC181103	4"X 100mm COMPLETO	107,51 €
AC181105	6"X 150mm COMPLETO	117,60 €
AC181106	8"X 200mm COMPLETO	126,39 €
AC181107	10"X 250mm COMPLETO	133,05 €
AC181108	12"X 300mm COMPLETO	136,04 €

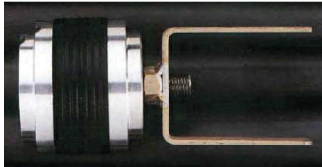

PISTON OBT. 1 GOMA SIN MANOMETRO

AC582050	TYPE A 40 (39- 56)	65,08 €
AC582051	TYPE A 50 (49- 65)	76,96 €
AC582052	TYPE A 65 (63- 75)	89,33 €
AC582053	TYPE A 80 (77- 95)	99,15 €
AC582054	TYPE A 90 (86-102)	112,59 €
AC582055	TYPE A 100 (97-120)	122,30 €
AC582056	TYPE A 110 (107-125)	135,27 €
AC582057	TYPE A 125 (120-143)	167,34 €
AC582058	TYPE A 140 (132-150)	195,32 €
AC582059	TYPE A 150 (147-170)	199,32 €
AC582060	TYPE A 160 (158-175)	199,32 €
AC582061	TYPE A 175 (170-192)	231,33 €
AC582062	TYPE A 200 (197-221)	274,25 €
AC582064	TYPE A 225 (220-240)	327,87 €
AC582065	TYPE A 250 (245-278)	382,89 €
AC582073	TYPE A 275 (270-300)	588,26 €
AC582066	TYPE A 300 (295-325)	609,97 €
AC582067	TYPE A 350	705,85 €
AC582068	TYPE A 400	880,50 €
AC582069	TYPE A 450	1.350,33 €
AC582070	TYPE A 500	1.631,50 €
AC582071	TYPE A 550	2.010,40 €

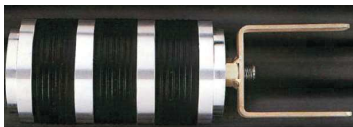

PISTON OBT. 3 GOMAS SIN MANOMETRO

AC582100	TYPE T/R 40 (39- 56)	125,96 €
AC582101	TYPE T/R 50 (49- 65)	154,70 €
AC582102	TYPE T/R 65 (63- 75)	181,22 €
AC582103	TYPE T/R 80 (77- 95)	206,34 €
AC582104	TYPE T/R 90 (86-102)	230,54 €
AC582105	TYPE T/R 100 (97-120)	249,47 €
AC582106	TYPE T/R 110 (107-125)	288,36 €
AC582107	TYPE T/R 125 (120-143)	352,11 €
AC582108	TYPE T/R 140 (132-150)	402,15 €
AC582109	TYPE T/R 150 (147-170)	440,10 €
AC582110	TYPE T/R 160 (158-175)	444,86 €
AC582111	TYPE T/R 175 (170-192)	556,79 €
AC582112	TYPE T/R 200 (197-221)	605,38 €
AC582114	TYPE T/R 225 (220-240)	752,92 €
AC582115	TYPE T/R 250 (245-278)	904,63 €
AC582116	TYPE T/R 300 (295-325)	1.410,90 €
AC582117	TYPE T/R 350	1.720,10 €
AC582118	TYPE T/R 400	2.047,92 €
AC582119	TYPE T/R 450	3.198,41 €
AC582120	TYPE T/R 500	3.712,75 €
AC582121	TYPE T/R 550	4.303,73 €
AC582122	TYPE T/R 600	4.530,93 €



BALONES PARA TUBERIAS SANEAMIENTO

AC581402	BALON PARA SANEAMIENTO CTS/S 200	1.140,76 €
AC581403	BALON PARA SANEAMIENTO CTS/S 250	1.174,65 €
AC581404	BALON PARA SANEAMIENTO CTS/S 300	1.310,09 €
AC581406	BALON PARA SANEAMIENTO CTS/S 400	1.363,56 €
AC581408	BALON PARA SANEAMIENTO CTS/S 500	1.449,70 €
AC581410	BALON PARA SANEAMIENTO CTS/S 600	1.639,83 €
AC581412	BALON PARA SANEAMIENTO CTS/S 700	1.844,81 €
AC581414	BALON PARA SANEAMIENTO CTS/S 800	2.156,74 €
AC581416	BALON PARA SANEAMIENTO CTS/S 1000	3.466,82 €
AC581418	BALON PARA SANEAMIENTO CTS/S 1200	4.072,85 €



PO03331000	BOMBA HINCHAR / DESHINCHAR TIPO P/3	265,00 €
------------	-------------------------------------	----------

VÁLVULAS DE FUNDICIÓN

VALVULAS DE COMPUERTA

PRODUCTO	CODIGO	Diametro	PN	PVP 2019 €
----------	--------	----------	----	------------



VALVULA COMPUERTA
EXTREMOS ROSCADOS

s/c	Rosca 3/4" DN20	PN10/16	40,48 €
s/c	Rosca 1" DN25	PN10/16	42,86 €
s/c	Rosca 1 1/4" DN32	PN10/16	50,00 €
s/c	Rosca 1 1/2" DN40	PN10/16	61,90 €
s/c	Rosca 2" DN50	PN10/17	76,19 €

GV10



VALVULA COMPUERTA
CIERRE ELÁSTICO
F4 con cuadradillo o volante

200A.040.111111	DN40	PN10/16	58,97 €
200A.050.111111	DN50	PN10/16	63,85 €
200A.065.111111	DN65	PN10/16	75,64 €
200A.080.111111	DN80	PN10/16	87,18 €
200A.100.111111	DN100	PN10/16	114,36 €
200A.125.111111	DN125	PN10/16	160,51 €
200A.150.111111	DN150	PN10/16	181,54 €
200A.200.112111	DN200	PN10	289,49 €
200A.200.111111	DN200	PN16	289,49 €
200A.250.112111	DN250	PN10	416,67 €
200A.250.111111	DN250	PN16	416,67 €
200A.300.112111	DN300	PN10	615,90 €
200A.300.111111	DN300	PN16	615,90 €
200A.350.112111	DN350	PN10	932,31 €
200A.350.111111	DN350	PN16	932,31 €
200A.400.112111	DN400	PN10	1.368,72 €
200A.400.111111	DN400	PN16	1.368,72 €
200A.450.112111	DN450	PN10	1.870,00 €
200A.450.111111	DN450	PN16	1.870,00 €
200A.500.112111	DN500	PN10	2.190,00 €
200A.500.111111	DN500	PN16	2.190,00 €
200A.600.112111	DN600	PN10	3.273,08 €
200A.600.111111	DN600	PN16	3.273,08 €

DIÁMETROS Y/O PRESIONES SUPERIORES, CONSULTAR



VOLANTE VALVULA COMPUERTA

DN40/50	180MM	3,92 €
DN65	180MM	3,92 €
DN80	200MM	4,81 €
DN100	250MM	10,50 €
DN125/150	280MM	10,93 €
DN200	340MM	18,38 €
DN250	340MM	18,38 €
DN300	400MM	26,25 €

VALVULAS DE VENTEO

PRODUCTO	CODIGO	Diametro	PN	PVP 2019 €
----------	--------	----------	----	------------



VALVULA VENTOSA TRIFUNCIONAL

500A.050.111111	DN50	PN10/16	65,01 €
500A.065.111111	DN65	PN10/16	65,23 €
500A.080.111111	DN80	PN10/16	68,67 €
500A.100.111111	DN100	PN10/16	84,27 €
500A.150.111111	DN150	PN10/16	99,57 €
500A.200.111111	DN200	PN10	137,33 €
500A.250.111111	DN250	PN10	174,16 €
500A.300.111111	DN300	PN10	316,67 €
500A.200.11212	DN200	PN16	318,71 €
500A.250.11211	DN250	PN16	466,31 €
500A.300.11211	DN300	PN16	466,31 €
500A.050.11311	DN50	PN25	641,32 €
500A.065.11311	DN65	PN25	641,32 €
500A.080.11311	DN80	PN25	1.472,44 €
500A.100.11311	DN100	PN25	1.547,88 €
500A.150.11311	DN150	PN25	1.651,90 €
500A.200.11311	DN200	PN25	1.668,60 €
500A.250.11311	DN250	PN25	3.251,53 €
500A.300.11311	DN300	PN25	3.397,55 €

VALVULAS DE FUNDICIÓN

OTROS MODELOS DE VÁLVULAS

VALVULAS DE MARIPOSA TIPO WAFER DISCO INOXIDABLE



CUERPO:
F.Dúctil GJS400
DISCO:
Acero Inox.CF8M
ASIENTO:
EPDM

EJE:
A.Inox AISI420
DISTANCIA ENTRE CARAS:
EN558-1 Serie 20
PINTURA EPOXY :
250 Mic



VALVULAS DE MARIPOSA EJE CENTRADO TIPO BRIDA SERIE 13 Y SERIE 20, CON DISCO FUNDICIÓN O INOXIDABLE



CUERPO:
F.Dúctil GJS400
DISCO:
Acero Inox.CF8M
ASIENTO:
EPDM VULCANIZADO

EJE:
A.Inox AISI420
DISTANCIA ENTRE CARAS:
EN558-1 Serie 13
PINTURA EPOXY :
250 Mic

VÁLVULAS DE MARIPOSA BIEXCÉNTRICA PN10/16/25/40



CUERPO:
F.Dúctil GJS400
DISCO:
F.Dúctil GJS400
ASIENTO:
A.Inox AISI316/NBR

EJE:
A.Inox AISI420
DISTANCIA ENTRE CARAS:
EN558-1 Serie 13/14
PINTURA EPOXY :
250 Mic

VÁLVULA DE RETENCIÓN DE BOLA TIPO BRIDAS O ROSCADAS



CUERPO:
F.Dúctil GJS500
DISCO:
Bola NBR alma metálica
ASIENTO:
NBR

DISTANCIA ENTRE CARAS:
DIN3202 Serie F6
PINTURA EPOXY :
250 Mic

VÁLVULAS DE RETENCIÓN CLAPETA ENGOMADA O METAL-METAL



CUERPO:
F.Dúctil GJS500
DISCO:
F.Dúctil GJS500+Latón
ASIENTO:
Latón

EJE:
A.Inox AISI420
DISTANCIA ENTRE CARAS:
DIN 3202 F6
PINTURA EPOXY :
250 Mic

VÁLVULAS DE RETENCIÓN DE DOBLE PLATO TIPO WAFER



CUERPO:
F.Dúctil GJL250
DISCO:
F.Dúctil GJS250/Inox.CF8M
ASIENTO:
NBR

DISTANCIA ENTRE CARAS:
EN558-1 Serie 16
PINTURA EPOXY :
250 Mic

FILTRO TIPO Y CON BRIDAS



CUERPO:
F.Dúctil GJS400
TAMIZ:
A.Inox AISI304

DISTANCIA ENTRE CARAS:
DIN3202 F1
PINTURA EPOXY :
250 Mic

CARERES DE DESMONTAJE VIROLA INOXIDABLE



VIROLA:
F.Dúctil GJS500
BRIDAS:
F.Dúctil GJS500
TORNILLERIA:
Acero 4,8 protección dacromet

VÁLVULAS AUTOMÁTICAS

VALVULAS AUTOMÁTICAS FLUCON

<p>REDUCTORA DE PRESIÓN (200.02)</p> <p>ALIVIO DE PRESION 200.03 (A)</p> <p>NIVEL ALTIMETRICO 200.05 (A)</p> <p>SOBRE VELOCIDAD 200.06 (OCI)</p> <p>CONTROL ELÉCTRICO (electroválvulas) 200.HD2 (BE)</p>	<p>REDUCTORA DE PRESIÓN DOBLE PILOTO PN 10/16 (200 02.02 HD2 (BE))</p> <p>SOSTENTADORA DE PRESION 200.03 (S)</p> <p>NIVEL ALTIMETRICO DIFERENCIAL 200.05 (DI)</p> <p>CONTROL BOMBA 200.07 (BP)</p> <p>NIVEL DIFERENCIAL 200.04 (DI)</p>	<p>REDUCTORA DE PRESION BAJO CAUDAL 200.02 (LF)</p> <p>NIVEL FIJO 200.04</p> <p>LIMITADORA DE CAUDAL 200.06 (OC)</p> <p>ANTICIPADORA DE ONDA 200.09</p> <p>RECAMBIOS VÁLVULA ASESORAMIENTO TÉCNICO</p>

DELEGACIONES

STPACUSTER North Europe
Ind. Terrein De Wildeman, Hof 4
Bossekamp 12 5301 Lz Zaltbommel
The Netherlands
hello@stpacuster.com
+31 418840003

STPACUSTER Central Europe
2, Kvetna 685, Areal Salvia
736 61 Napajedla
Czech Republic
hello@stpacuster.com
+420 577913065

STPACUSTER Baltic
Bullu Str. 45
Riga, Lv1067 - Latvia
hello@stpacuster.com
+371 67815281

STPACUSTER South Africa
54 Richard Road, Industria North
Po Box 2203 Wilro Park
1731 Roodepoort - South Africa
hello@stpacuster.com
+27 315397451

AGRUACUSTER Chile
Lo Echevers 891,
Bodegas 11 Y 12, Quilicura,
Santiago - Chile
hello@stpacuster.com
+56 229493910

AGRUACUSTER Brasil
Rua Saburo Sumiya, 211
Aldeia, Barueri, Sp
Cep: 06440 - 110 - Brasil
hello@stpacuster.com
+55 114138088

GRUPO STPACUSTER

Rambla d'Ègara, 340 4th floor
08221 Terrassa (Barcelona) - SPAIN
Mail: hello@stpacuster.com
Phone: +34 93 736 18 80

www.stpacustergroup.com